



**THE DATASHEET OF
LT1785HS8#PBF**



60V Fault Protected RS485/RS422 Transceivers

FEATURES

- Protected from Overvoltage Line Faults to $\pm 60V$
- Pin Compatible with LTC485 and LTC491
- High Input Impedance Supports Up to 128 Nodes
- No Damage or Latchup to ESD
 - IEC-1000-4-2 Level 4: $\pm 15kV$ Air Discharge
 - IEC-1000-4-2 Level 2: $\pm 4kV$ Contact Discharge
- Controlled Slew Rates for EMI Emissions Control
- Guaranteed High Receiver Output State for Floating, Shorted or Inactive Inputs (LT1785A/LT1791A)
- Outputs Assume a High Impedance When Off or Powered Down
- Drives Low Cost, Low Impedance Cables
- Short-Circuit Protection on All Outputs
- Thermal Shutdown Protection
- Guaranteed Operation to $125^{\circ}C$

APPLICATIONS

- Industrial Control Data Networks
- CAN Bus Applications
- HVAC Controls

LT, LT, LTC, LTM, μ Module, Linear Technology and the Linear logo are registered trademarks of Linear Technology Corporation. All other trademarks are the property of their respective owners.

DESCRIPTION

The **LT[®]1785/LT1791** are half-duplex and full-duplex differential bus transceivers for RS485 and RS422 applications which feature on-chip protection from overvoltage faults on the data transmission lines. Receiver input and driver output pins can withstand voltage faults up to $\pm 60V$ with respect to ground with no damage to the device. Faults may occur while the transceiver is active, shut down or powered off.

Data rates to 250kbaud on networks of up to 128 nodes are supported. Controlled slew rates on the driver outputs control EMI emissions and improve data transmission integrity on improperly terminated lines. Drivers are specified to operate with inexpensive cables as low as 72Ω characteristic impedance.

The LT1785A/LT1791A devices have “fail-safe” receiver inputs to guarantee a receiver output high for shorted, open or inactive data lines. On-chip ESD protection eliminates need for external protection devices.

The LT1785/LT1785A are available in 8-lead DIP and SO packages and the LT1791/LT1791A in 14-lead DIP and SO packages.

TYPICAL APPLICATION

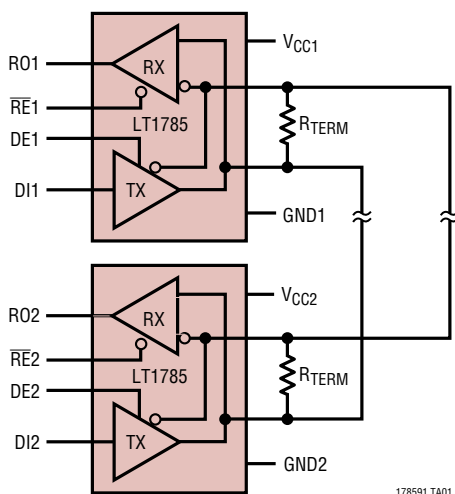

Normal Operation Waveforms at 250kbaud

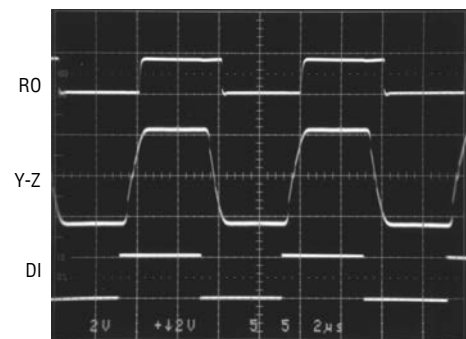

LT1785/LT1785A/ LT1791/LT1791A

ABSOLUTE MAXIMUM RATINGS (Note 1)

| | | | |
|------------------------------------|----------------------------|--|----------------|
| Supply Voltage (V_{CC}) | 18V | Operating Temperature Range | |
| Receiver Enable Input Voltage..... | -0.3V to 6V | LT1785C/LT1791C/ | |
| Driver Enable Input Voltage..... | -0.3V to 6V | LT1785AC/LT1791AC..... | 0°C to 70°C |
| Driver Input Voltage..... | -0.3V to 18V | LT1785I/LT1791I/ | |
| Receiver Input Voltage..... | -60V to 60V | LT1785AI/LT1791AI..... | -40°C to 85°C |
| Driver Output Voltage..... | -60V to 60V | LT1785H/LT1791H/ | |
| Receiver Output Voltage..... | -0.3V to ($V_{CC} + 6V$) | LT1785AH/LT1791AH..... | -40°C to 125°C |
| | | Storage Temperature Range..... | -65°C to 150°C |
| | | Lead Temperature (Soldering, 10 sec) | 300°C |

PIN CONFIGURATION

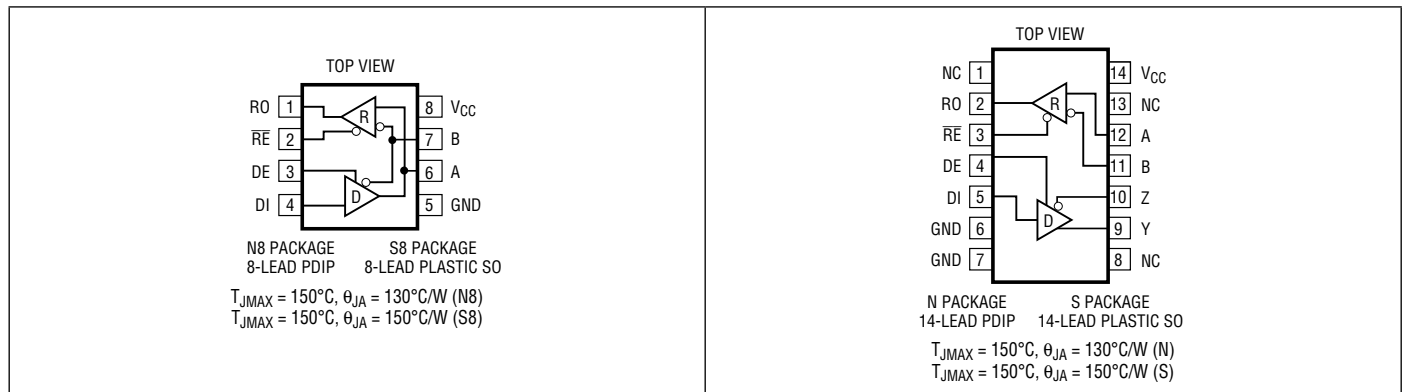

ORDER INFORMATION

| LEAD FREE FINISH | TAPE AND REEL | PART MARKING* | PACKAGE DESCRIPTION | TEMPERATURE RANGE |
|------------------|------------------|---------------|---------------------|-------------------|
| LT1785CN8#PBF | LT1785CN8#TRPBF | 1785 | 8-Lead PDIP | 0°C to 70°C |
| LT1785CS8#PBF | LT1785CS8#TRPBF | 1785 | 8-Lead Plastic SO | 0°C to 70°C |
| LT1785IN8#PBF | LT1785IN8#TRPBF | 1785I | 8-Lead PDIP | -40°C to 85°C |
| LT1785IS8#PBF | LT1785IS8#TRPBF | 1785I | 8-Lead Plastic SO | -40°C to 85°C |
| LT1785ACN8#PBF | LT1785ACN8#TRPBF | 1785A | 8-Lead PDIP | 0°C to 70°C |
| LT1785ACS8#PBF | LT1785ACS8#TRPBF | 1785A | 8-Lead Plastic SO | 0°C to 70°C |
| LT1785AIN8#PBF | LT1785AIN8#TRPBF | 1785AI | 8-Lead PDIP | -40°C to 85°C |
| LT1785AIS8#PBF | LT1785AIS8#TRPBF | 1785AI | 8-Lead Plastic SO | -40°C to 85°C |
| LT1785HN8#PBF | LT1785HN8#TRPBF | 1785H | 8-Lead PDIP | -40°C to 125°C |
| LT1785HS8#PBF | LT1785HS8#TRPBF | 1785H | 8-Lead Plastic SO | -40°C to 125°C |
| LT1785AHN8#PBF | LT1785AHN8#TRPBF | 1785AH | 8-Lead PDIP | -40°C to 125°C |
| LT1785AHS8#PBF | LT1785AHS8#TRPBF | 1785AH | 8-Lead Plastic SO | -40°C to 125°C |
| LT1791CN#PBF | LT1791CN#TRPBF | 1791 | 14-Lead PDIP | 0°C to 70°C |
| LT1791CS#PBF | LT1791CS#TRPBF | 1791 | 14-Lead Plastic SO | 0°C to 70°C |

178591fd

ORDER INFORMATION

| LEAD FREE FINISH | TAPE AND REEL | PART MARKING* | PACKAGE DESCRIPTION | TEMPERATURE RANGE |
|-------------------|-----------------|---------------|---------------------|-------------------|
| LT1791IN#PBF | LT1791IN#TRPBF | 1791I | 14-Lead PDIP | -40°C to 85°C |
| LT1791IS#PBF | LT1791IS#TRPBF | 1791I | 14-Lead Plastic SO | -40°C to 85°C |
| LT1791ACN#PBF | LT1791ACN#TRPBF | 1791A | 14-Lead PDIP | 0°C to 70°C |
| LT1791ACS#PBF | LT1791ACS#TRPBF | 1791A | 14-Lead Plastic SO | 0°C to 70°C |
| LT1791AIN#PBF | LT1791AIN#TRPBF | 1791AI | 14-Lead PDIP | -40°C to 85°C |
| LT1791AIS#PBF | LT1791AIS#TRPBF | 1791AI | 14-Lead Plastic SO | -40°C to 85°C |
| LT1791HN#PBF | LT1791HN#TRPBF | 1791H | 14-Lead PDIP | -40°C to 125°C |
| LT1791HS#PBF | LT1791HS#TRPBF | 1791H | 14-Lead Plastic SO | -40°C to 125°C |
| LT1791AHN#PBF | LT1791AHN#TRPBF | 1791AH | 14-Lead PDIP | -40°C to 125°C |
| LT1791AHS#PBF | LT1791AHS#TRPBF | 1791AH | 14-Lead Plastic SO | -40°C to 125°C |
| LEAD BASED FINISH | TAPE AND REEL | PART MARKING* | PACKAGE DESCRIPTION | TEMPERATURE RANGE |
| LT1785CN8 | LT1785CN8#TR | 1785 | 8-Lead PDIP | 0°C to 70°C |
| LT1785CS8 | LT1785CS8#TR | 1785 | 8-Lead Plastic SO | 0°C to 70°C |
| LT1785IN8 | LT1785IN8#TR | 1785I | 8-Lead PDIP | -40°C to 85°C |
| LT1785IS8 | LT1785IS8#TR | 1785I | 8-Lead Plastic SO | -40°C to 85°C |
| LT1785ACN8 | LT1785ACN8#TR | 1785A | 8-Lead PDIP | 0°C to 70°C |
| LT1785ACS8 | LT1785ACS8#TR | 1785A | 8-Lead Plastic SO | 0°C to 70°C |
| LT1785AIN8 | LT1785AIN8#TR | 1785AI | 8-Lead PDIP | -40°C to 85°C |
| LT1785AIS8 | LT1785AIS8#TR | 1785AI | 8-Lead Plastic SO | -40°C to 85°C |
| LT1785HN8 | LT1785HN8#TR | 1785H | 8-Lead PDIP | -40°C to 125°C |
| LT1785HS8 | LT1785HS8#TR | 1785H | 8-Lead Plastic SO | -40°C to 125°C |
| LT1785AHN8 | LT1785AHN8#TR | 1785AH | 8-Lead PDIP | -40°C to 125°C |
| LT1785AHS8 | LT1785AHS8#TR | 1785AH | 8-Lead Plastic SO | -40°C to 125°C |
| LT1791CN | LT1791CN#TR | 1791 | 14-Lead PDIP | 0°C to 70°C |
| LT1791CS | LT1791CS#TR | 1791 | 14-Lead Plastic SO | 0°C to 70°C |
| LT1791IN | LT1791IN#TR | 1791I | 14-Lead PDIP | -40°C to 85°C |
| LT1791IS | LT1791IS#TR | 1791I | 14-Lead Plastic SO | -40°C to 85°C |
| LT1791ACN | LT1791ACN#TR | 1791A | 14-Lead PDIP | 0°C to 70°C |
| LT1791ACS | LT1791ACS#TR | 1791A | 14-Lead Plastic SO | 0°C to 70°C |
| LT1791AIN | LT1791AIN#TR | 1791AI | 14-Lead PDIP | -40°C to 85°C |
| LT1791AIS | LT1791AIS#TR | 1791AI | 14-Lead Plastic SO | -40°C to 85°C |
| LT1791HN | LT1791HN#TR | 1791H | 14-Lead PDIP | -40°C to 125°C |
| LT1791HS | LT1791HS#TR | 1791H | 14-Lead Plastic SO | -40°C to 125°C |
| LT1791AHN | LT1791AHN#TR | 1791AH | 14-Lead PDIP | -40°C to 125°C |
| LT1791AHS | LT1791AHS#TR | 1791AH | 14-Lead Plastic SO | -40°C to 125°C |

Consult LTC Marketing for parts specified with wider operating temperature ranges. *The temperature grade is identified by a label on the shipping container.

For more information on lead free part marking, go to: <http://www.linear.com/leadfree/>

This product is only offered in trays. For more information go to: <http://www.linear.com/packaging/>

LT1785/LT1785A/ LT1791/LT1791A

DC ELECTRICAL CHARACTERISTICS

The ● denotes the specifications which apply over the full operating temperature range, otherwise specifications are at $T_A = 25^\circ\text{C}$, $V_{CC} = 5\text{V}$.

| SYMBOL | PARAMETER | CONDITIONS | MIN | TYP | MAX | UNITS | |
|------------------|---|--|------------------|-------------------|--------------------------|---|--|
| V_{OD1} | Differential Driver Output Voltage (Unloaded) | $I_O = 0$ | ● | 4.1 | 5 | V | |
| V_{OD2} | Differential Driver Output Voltage (With Load) | $R = 50\Omega$ (RS422), Figure 1 $R = 27\Omega$ (RS485), Figure 1 $R = 18\Omega$ | ● ● ● | 2.0 1.5 1.2 | 2.70 2.45 2.2 | V V V | |
| V_{OD} | Change in Magnitude of Driver Differential Output Voltage for Complementary Output States | $R = 27\Omega$ or $R = 50\Omega$, Figure 1 | ● | | 0.2 | V | |
| V_{OC} | Driver Common Mode Output Voltage | $R = 27\Omega$ or $R = 50\Omega$, Figure 1 | ● | 2 | 2.5 | 3 | V |
| $\Delta V_{OC} $ | Change in Magnitude of Driver Common Mode Output Voltage for Complementary Output States | $R = 27\Omega$ or $R = 50\Omega$, Figure 1 | ● | | 0.2 | V | |
| V_{IH} | Input High Voltage | DI, DE, \overline{RE} | ● | 2 | | V | |
| V_{IL} | Input Low Voltage | DI, DE, \overline{RE} | ● | | 0.8 | V | |
| I_{IN1} | Input Current | DI, DE, \overline{RE} | ● | | 5 | μA | |
| I_{IN2} | Input Current (A, B); (LT1791 or LT1785 with DE = 0V) | $V_{IN} = 12\text{V}$ $V_{IN} = -7\text{V}$ $-60\text{V} \leq V_{IN} \leq 60\text{V}$ | ● ● ● | -0.15 -6 | 0.15 -0.08 6 | mA mA mA | |
| V_{TH} | Differential Input Threshold Voltage for Receiver | LT1785/LT1791: $-7\text{V} \leq V_{CM} \leq 12\text{V}$ LT1785A/LT1791A: $-7\text{V} \leq V_{CM} \leq 12\text{V}$ | ● ● | -0.2 -0.2 | 0.2 0 | V V | |
| ΔV_{TH} | Receiver Input Hysteresis | $-7\text{V} < V_{CM} < 12\text{V}$ | | 20 | | mV | |
| V_{OH} | Receiver Output High Voltage | $I_O = -400\mu\text{A}$, $V_{ID} = 200\text{mV}$ | ● | 3.5 | 4 | V | |
| V_{OL} | Receiver Output Low Voltage | $I_O = 1.6\text{mA}$, $V_{ID} = -200\text{mV}$ | ● | | 0.3 | 0.5 | V |
| | Three-State (High Impedance) Output Current at Receiver $0\text{V} < V_{OUT} < 6\text{V}$ | $\overline{RE} > 2\text{V}$ or Power Off | ● | -1 | 1 | μA | |
| R_{IN} | Receiver Input Resistance (LT1791) | $-7\text{V} \leq V_{CM} \leq 12\text{V}$ $-60\text{V} \leq V_{CM} \leq 60\text{V}$ | ● | 85 | 125 | $\text{k}\Omega$ $\text{k}\Omega$ | |
| | LT1785 | $-7\text{V} \leq V_{CM} \leq 12\text{V}$ | ● | 50 | 90 | $\text{k}\Omega$ | |
| | RS485 Unit Load | | | | 0.25 | | |
| I_{SC} | Driver Short-Circuit Current | $V_{OUT} = \text{HIGH}$, Force $V_O = -7\text{V}$ $V_{OUT} = \text{LOW}$, Force $V_O = 12\text{V}$ | ● ● | 35 35 | 250 250 | mA mA | |
| | Driver Output Fault Current | $V_O = 60\text{V}$ $V_O = -60\text{V}$ | ● ● | -6 | 6 | mA mA | |
| | Receiver Short-Circuit Current | $0\text{V} \leq V_O \leq V_{CC}$ | ● | | ± 35 | mA | |
| | Driver Three-State Output Current | $-7\text{V} \leq V_O \leq 12\text{V}$ $-60\text{V} \leq V_O \leq 60\text{V}$ | ● ● | -0.2 -6 | 0.3 6 | mA mA | |
| I_{CC} | Supply Current | No Load, $\overline{RE} = 0\text{V}$, DE = 5V No Load, $\overline{RE} = 5\text{V}$, DE = 5V No Load, $\overline{RE} = 0\text{V}$, DE = 0V No Load, $\overline{RE} = 5\text{V}$, DE = 0V | ● ● ● ● | | 5.5 5.5 4.5 0.2 | 9 9 8 0.3 | mA mA mA mA |

SWITCHING CHARACTERISTICS The ● denotes the specifications which apply over the full operating temperature range, otherwise specifications are at $T_A = 25^\circ\text{C}$, $V_{CC} = 5\text{V}$.

| SYMBOL | PARAMETER | CONDITIONS | | MIN | TYP | MAX | UNITS |
|----------------|--|---|---|-----|-----|------|---------------|
| t_{PLH} | Driver Input to Output | Figures 3, 5 | ● | | 700 | 2000 | ns |
| t_{PHL} | Driver Input to Output | Figures 3, 5 | ● | | 700 | 2000 | ns |
| t_{SKEW} | Driver Output to Output | Figures 3, 5 | | | 100 | | ns |
| t_r, t_f | Driver Rise or Fall Time | Figures 3, 5 | ● | 200 | 800 | 2000 | ns |
| t_{ZH} | Driver Enable to Output High | Figures 4, 6 | ● | | 500 | 3000 | ns |
| t_{ZL} | Driver Enable to Output Low | Figures 4, 6 | ● | | 800 | 3000 | ns |
| t_{LZ} | Driver Disable Time from Low | Figures 4, 6 | ● | | 200 | 5000 | ns |
| t_{HZ} | Driver Disable Time from High | Figures 4, 6 | ● | | 800 | 5000 | ns |
| t_{PLH} | Receiver Input to Output | Figures 3, 7 | ● | | 400 | 900 | ns |
| t_{PHL} | Receiver Input to Output | Figures 3, 7 | ● | | 400 | 900 | ns |
| t_{SKD} | Differential Receiver Skew | | | | 200 | | ns |
| t_{ZL} | Receiver Enable to Output Low | Figures 2, 8 | ● | | 300 | 1000 | ns |
| t_{ZH} | Receiver Enable to Output High | Figures 2, 8 | ● | | 300 | 1000 | ns |
| t_{LZ} | Receiver Disable from Low | Figures 2, 8 | ● | | 400 | 1000 | ns |
| t_{HZ} | Receiver Disable from High | Figures 2, 8 | ● | | 400 | 1000 | ns |
| f_{MAX} | Maximum Data Rate | | ● | 250 | | | kbps |
| t_{SHDN} | Time to Shut Down | Figures 2, 6, 8 | | | 3 | | μs |
| $t_{ZH(SHDN)}$ | Driver Enable from Shutdown to Output High | Figures 2, 6; $\overline{RE} = 5\text{V}$ | | | 12 | | μs |
| $t_{ZL(SHDN)}$ | Driver Enable from Shutdown to Output Low | Figures 2, 6; $\overline{RE} = 5\text{V}$ | | | 12 | | μs |
| $t_{ZH(SHDN)}$ | Receiver Enable from Shutdown to Output High | Figures 2, 8; $DE = 0\text{V}$ | | | 4 | | μs |
| $t_{ZL(SHDN)}$ | Receiver Enable from Shutdown to Output Low | Figures 2, 8; $DE = 0\text{V}$ | | | 4 | | μs |

Note 1: Stresses beyond those listed under Absolute Maximum Ratings may cause permanent damage to the device. Exposure to any Absolute Maximum Rating condition for extended periods may affect device reliability and lifetime.

TYPICAL PERFORMANCE CHARACTERISTICS

Driver Differential Output Voltage vs Load Resistance

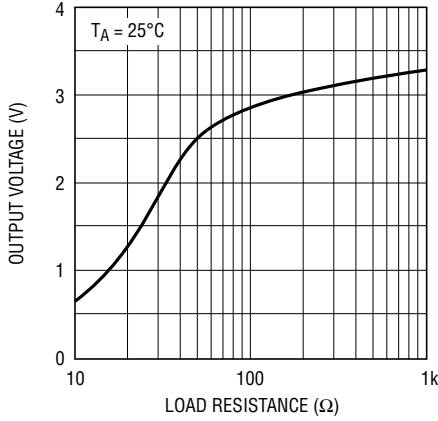

Driver Differential Output Voltage vs Temperature



Receiver Propagation Delay vs Temperature

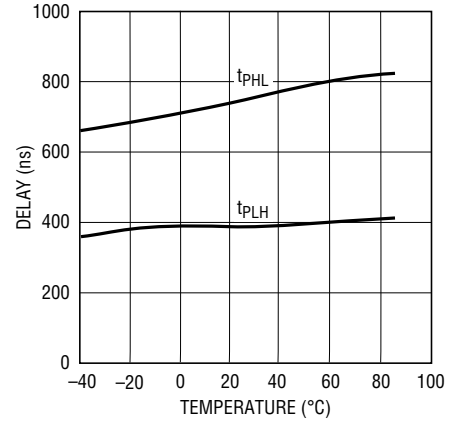

Driver Propagation Delay vs Temperature

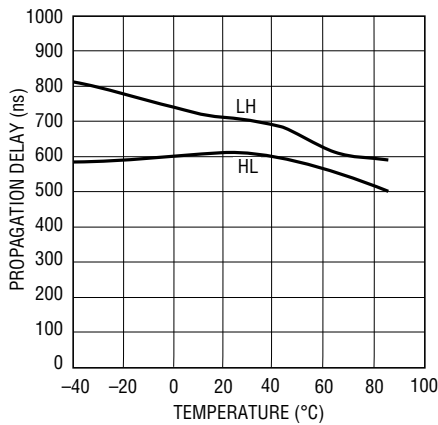

LT1791 Driver Output Leakage DE = 0V

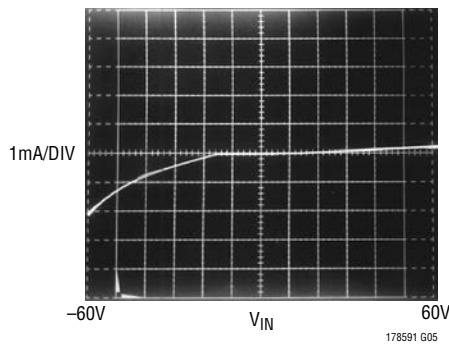

LT1791 Receiver Input Current vs VIN

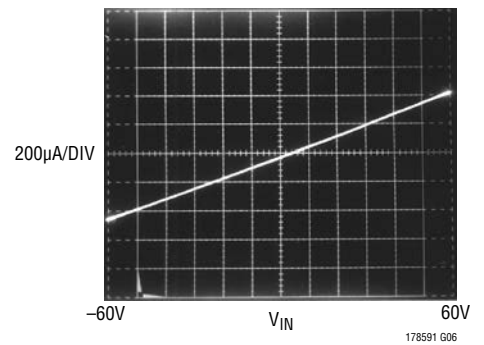

LT1785 Input Characteristics Pins A or B; DE = RE = 0V

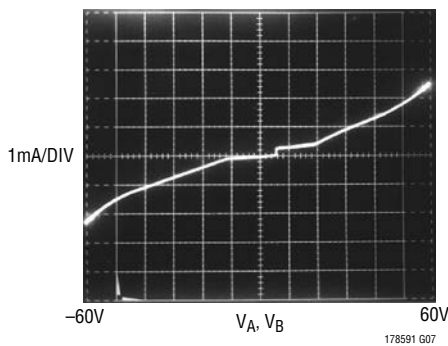

Supply Current vs Temperature

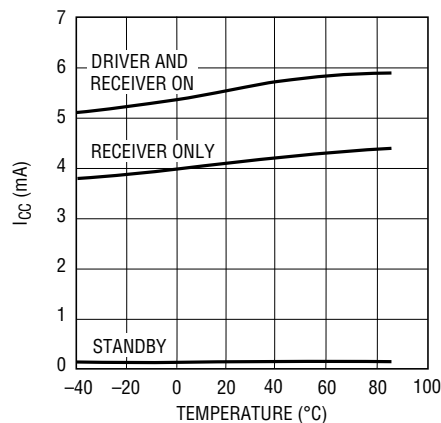

Receiver Propagation Delay vs Differential Input Voltage

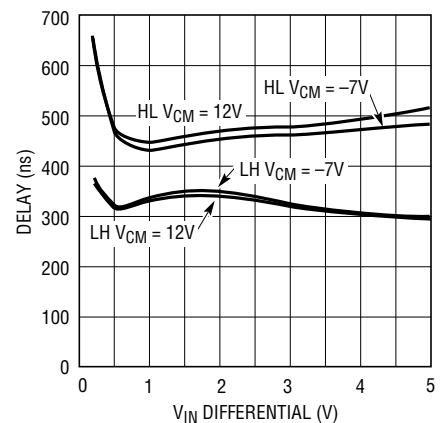

PIN FUNCTIONS

RO: Receiver Output. TTL level logic output. If the receiver is active (\overline{RE} pin low), RO is high if receiver input A \geq B by 200mV. If A \leq B by 200mV, then RO will be low. RO assumes a high impedance output state when \overline{RE} is high or the part is powered off. RO is protected from output shorts from ground to 6V.

\overline{RE} : Receiver Output Enable. TTL level logic input. A logic low on \overline{RE} enables normal operation of the receiver output RO. A logic high level at \overline{RE} places the receiver output pin RO into a high impedance state. If receiver enable \overline{RE} and driver enable DE are both in the disable state, the circuit goes to a low power shutdown state. Placing either \overline{RE} or DE into its active state brings the circuit out of shutdown. Shutdown state is not entered until a 3 μ s delay after both \overline{RE} and DE are disabled, allowing for logic skews in toggling between transmit and receive modes of operation. For CAN bus applications, \overline{RE} should be tied low to prevent the circuit from entering shutdown.

DE: Driver Output Enable. TTL level logic input. A logic high on DE enables normal operation of the driver outputs (Y and Z on LT1791, A and B on LT1785). A logic low level at DE places the driver output pins into a high impedance state. If receiver enable \overline{RE} and driver enable DE are both in the disable state, the circuit goes to a low power shutdown state. Placing either \overline{RE} or DE into its active state brings the circuit out of shutdown. Shutdown state is not entered until a 3 μ s delay after both \overline{RE} and DE are disabled, allowing for logic skews in toggling between transmit and receive modes of operation. For CAN bus operation the DE pin is used for signal input to place the data bus in dominant or recessive states.

DI: Driver Input. TTL level logic input. A logic high at DI causes driver output A or Y to a high state, and output B or Z to a low state. Complementary output states occur for DI low. For CAN bus applications DI should be tied low.

GND: Ground.

Y: Driver Output. The Y driver output is in phase with the driver input DI. In the LT1785 driver output Y is internally connected to receiver input A. The driver output assumes a high impedance state when DE is low, power is off or thermal shutdown is activated. The driver output is protected from shorts between $\pm 60V$ in both active and high impedance modes. For CAN applications, output Y is the CANL output node.

Z: Driver Output. The Z driver output is opposite in phase to the driver input DI. In the LT1785 driver output Z is internally connected to receiver input B. The driver output assumes a high impedance state when DE is low, power is off or thermal shutdown is activated. The driver output is protected from shorts between $\pm 60V$ in both active and high impedance modes. For CAN applications, output Z is the CANH output node.

A: Receiver Input. The A receiver input forces a high receiver output when $V(A) \geq [V(B) + 200mV]$. $V(A) \leq [V(B) - 200mV]$ forces a receiver output low. Receiver inputs A and B are protected against voltage faults between $\pm 60V$. The high input impedance allows up to 128 LT1785 or LT1791 transceivers on one RS485 data bus.

The LT1785A/LT1791A have guaranteed receiver input thresholds $-200mV < V_{TH} < 0$. Receiver outputs are guaranteed to be in a high state for 0V inputs.

B: Receiver Input. The B receiver input forces a high receiver output when $V(A) \geq [V(B) + 200mV]$. When $V(A) \leq [V(B) - 200mV]$, the B receiver forces a receiver output low. Receiver inputs A and B are protected against voltage faults between $\pm 60V$. The high input impedance allows up to 128 LT1785 or LT1791 transceivers on one RS485 data bus.

The LT1785A/LT1791A have guaranteed receiver input thresholds $-200mV < V_{TH} < 0$. Receiver outputs are guaranteed to be in a high state for 0V inputs.

V_{CC}: Positive Supply Input. For RS422 or RS485 operation, $4.75V \leq V_{CC} \leq 5.25V$. Higher V_{CC} input voltages increase output drive swing. V_{CC} should be decoupled with a 0.1 μ F low ESR capacitor directly at Pin 8 (V_{CC}).

TEST CIRCUITS

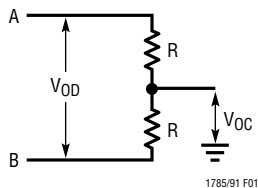

Figure 1. Driver DC Test Load

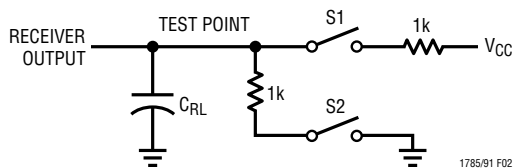

Figure 2. Receiver Timing Test Load

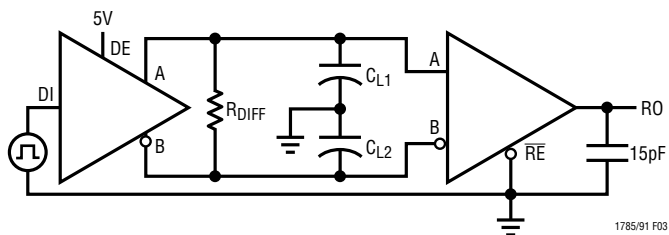

Figure 3. Driver/Receiver Timing Test Circuit

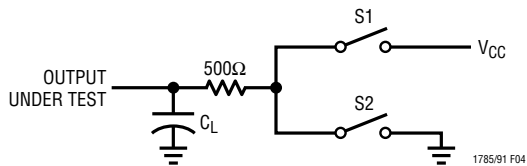

Figure 4. Driver Timing Test Load

FUNCTION TABLES

LT1785 Transmitting

| \overline{RE} | INPUTS | | OUTPUTS | | |
|-----------------|--------|----|---------|------|------|
| | DE | DI | A | B | RO |
| 0 | 1 | 0 | 0 | 1 | 0 |
| 0 | 1 | 1 | 1 | 0 | 1 |
| 1 | 0 | X | Hi-Z | Hi-Z | Hi-Z |
| 1 | 1 | 0 | 0 | 1 | Hi-Z |
| 1 | 1 | 1 | 1 | 0 | Hi-Z |

LT1785 Receiving

| \overline{RE} | INPUTS | | OUTPUT | |
|-----------------|--------|----|-----------------------|------|
| | DE | DI | A-B | RO |
| 0 | 0 | X | $\leq -200\text{mV}$ | 0 |
| 0 | 0 | X | $\geq 200\text{mV}^*$ | 1 |
| 0 | 0 | X | Open | 1** |
| 1 | 0 | X | X | Hi-Z |

* $\geq 0\text{mV}$ for LT1785A

** 1 for LT1785A; 1 or 0 for LT1785

LT1791

| \overline{RE} | INPUTS | | | OUTPUTS | | |
|-----------------|--------|----|-----------------------|---------|------|------|
| | DE | DI | A-B | Y | Z | RO |
| 0 | 0 | X | $\leq -200\text{mV}$ | Hi-Z | Hi-Z | 0 |
| 0 | 0 | X | $\geq 200\text{mV}^*$ | Hi-Z | Hi-Z | 1 |
| 0 | 0 | X | Open | Hi-Z | Hi-Z | 1** |
| 0 | 1 | 0 | $\leq -200\text{mV}$ | 0 | 1 | 0 |
| 0 | 1 | 0 | $\geq 200\text{mV}^*$ | 0 | 1 | 1 |
| 0 | 1 | 0 | Open | 0 | 1 | 1** |
| 0 | 1 | 1 | $\leq -200\text{mV}$ | 1 | 0 | 0 |
| 0 | 1 | 1 | $\geq 200\text{mV}^*$ | 1 | 0 | 1 |
| 0 | 1 | 1 | Open | 1 | 0 | 1** |
| 1 | 0 | X | X | Hi-Z | Hi-Z | Hi-Z |
| 1 | 1 | 0 | X | 0 | 1 | Hi-Z |
| 1 | 1 | 1 | X | 1 | 0 | Hi-Z |

* $\geq 0\text{mV}$ for LT1791A

** 1 for LT1791A; 1 or 0 for LT1791

SWITCHING TIME WAVEFORMS

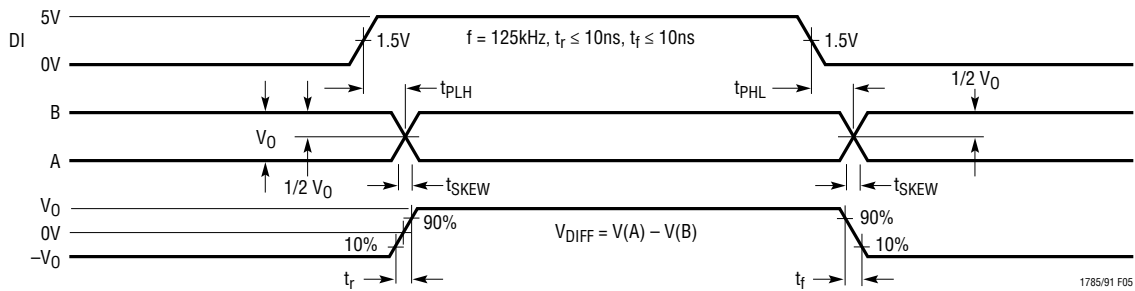

Figure 5. Driver Propagation Delays

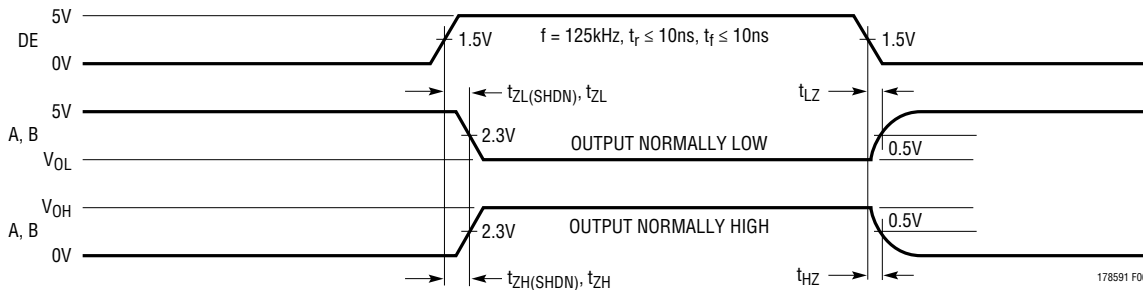

Figure 6. Driver Enable and Disable Times

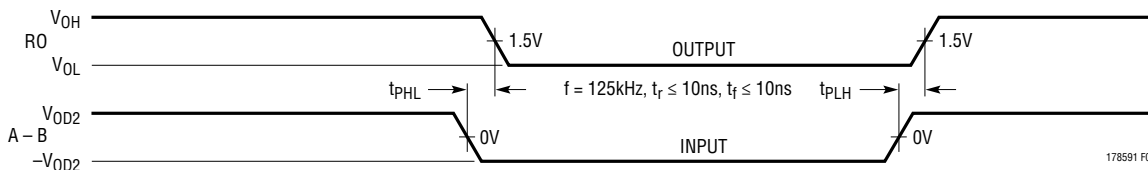

Figure 7. Receiver Propagation Delays

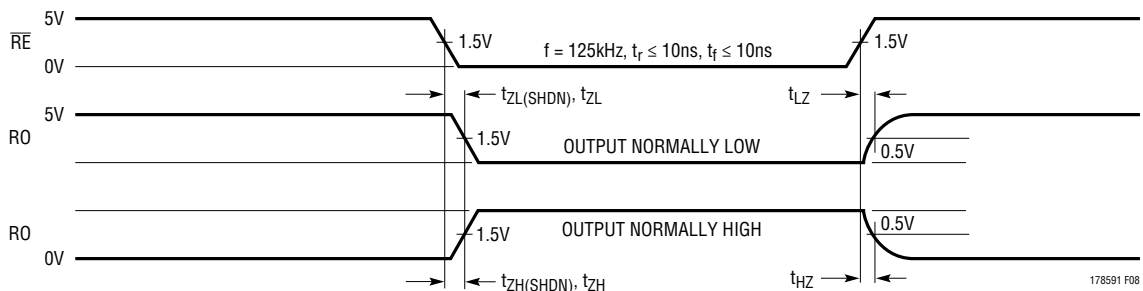

Figure 8. Receiver Enable and Disable Times

APPLICATIONS INFORMATION

Overvoltage Protection

The LT1785/LT1791 RS485/RS422 transceivers answer an applications need for overvoltage fault tolerance on data networks. Industrial installations may encounter common mode voltages between nodes far greater than the -7V to 12V range specified for compliance to RS485 standards. CMOS RS485 transceivers can be damaged by voltages above their absolute maximum ratings of typically -8V to 12.5V . Replacement of standard RS485 transceiver components with the LT1785 or LT1791 devices eliminates field failures due to overvoltage faults or the use of costly external protection devices. The limited overvoltage tolerance of CMOS RS485 transceivers makes implementation of effective external protection networks difficult without interfering with proper data network performance within the -7V to 12V region of RS485 operation.

The high overvoltage rating of the LT1785/LT1791 facilitates easy extension to almost any level. Simple discrete component networks that limit the receiver input and driver output voltages to less than $\pm 60\text{V}$ can be added to the device to extend protection to any desired level. Figure 11 shows a protection network against faults to the 120VAC line voltage.

The LT1785/LT1791 protection is achieved by using a high voltage bipolar integrated circuit process for the transceivers. The naturally high breakdown voltages of the bipolar process provides protection in powered-off and high impedance conditions. The driver outputs use a foldback current limit design to protect against overvoltage faults while still allowing high current output drive.

ESD Protection

The LT1785/LT1791 I/O pins have on-chip ESD protection circuitry to eliminate field failures caused by discharges to exposed ports and cables in application environments. The

LT1785 pins A and B and the LT1791 driver output pins Y and Z are protected to IEC-1000-4-2 level 2. These pins will survive multiple ESD strikes of $\pm 15\text{kV}$ air discharge or $\pm 4\text{kV}$ contact discharge. Due to their very high input impedance, the LT1791 receiver pins are protected to IEC-1000-4-2 level 2, or $\pm 15\text{kV}$ air and $\pm 4\text{kV}$ contact discharges. This level of ESD protection will guarantee immunity from field failures in all but the most severe ESD environments. The LT1791 receiver input ESD tolerance may be increased to IEC level 4 compliance by adding 2.2k resistors in series with these pins.

Low Power Shutdown

The LT1785/LT1791 have $\overline{\text{RE}}$ and DE logic inputs to control the receive and transmit modes of the transceivers. The $\overline{\text{RE}}$ input allows normal data reception when in the low state. The receiver output goes to a high impedance state when $\overline{\text{RE}}$ is high, allowing multiplexing the RO data line. The DE logic input performs a similar function on the driver outputs. A high state on DE activates the differential driver outputs, a low state places both driver outputs in to high impedance. Tying the $\overline{\text{RE}}$ and DE logic inputs together may be done to allow one logic signal to toggle the transceiver from receive to transmit modes. The DE input is used as the data input in CAN bus applications.

Disabling both the driver and receiver places the device into a low supply current shutdown mode. An internal time delay of $3\mu\text{s}$ minimum prevents entering shutdown due to small logic skews when a toggle between receive and transmit is desired. The recovery time from shutdown mode is typically $12\mu\text{s}$. The user must be careful to allow for this wake-up delay from shutdown mode. To allow full 250kbaud data rate transmission in CAN applications, the $\overline{\text{RE}}$ pin should be tied low to prevent entering shutdown mode.

APPLICATIONS INFORMATION

Slew Limiting for EMI Emissions Control

The LT1785/LT1791 feature controlled driver output slew rates to control high frequency EMI emissions from equipment and data cables. The slew limiting limits data rate operation to 250kbaud. Slew limiting also mitigates the adverse affects of imperfect transmission line termination caused by stubs or mismatched cable. In some low speed, short distance networks, cable termination may be eliminated completely with no adverse effect on data transmission.

Data Network Cable Selection and Termination

Long distance data networks operating at high data transmission rates should use high quality, low attenuation cable with well-matched cable terminations. Short distance networks at low data rates may use much less expensive PVC cable. These cables have characteristic impedances as low as 72Ω . The LT1785/LT1791 output drivers are guaranteed to drive cables as low as 72Ω .

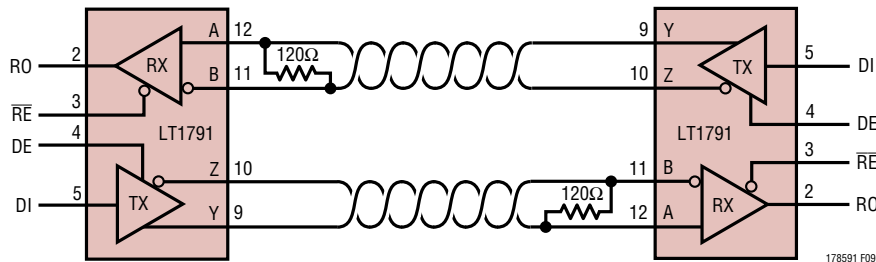
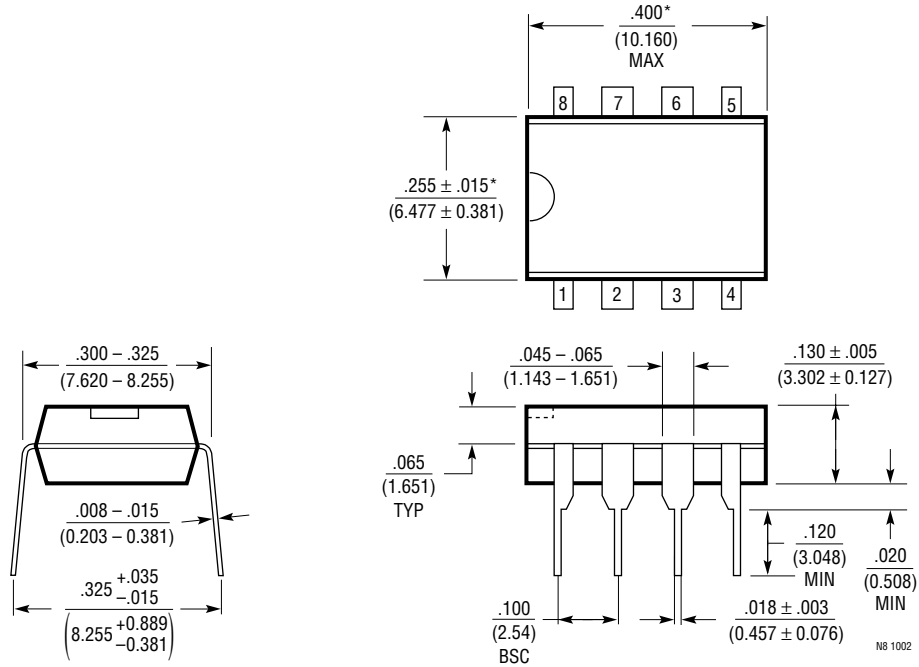

Figure 9. Full-Duplex RS422

PACKAGE DESCRIPTION

N8 Package
8-Lead PDIP (Narrow 0.300)
(LTC DWG # 05-08-1510)



NOTE:

1. DIMENSIONS ARE $\frac{\text{INCHES}}{\text{MILLIMETERS}}$

*THESE DIMENSIONS DO NOT INCLUDE MOLD FLASH OR PROTRUSIONS.
MOLD FLASH OR PROTRUSIONS SHALL NOT EXCEED .010 INCH (0.254mm)

PACKAGE DESCRIPTION

S8 Package
8-Lead Plastic Small Outline (Narrow 0.150)
 (LTC DWG # 05-08-1610)

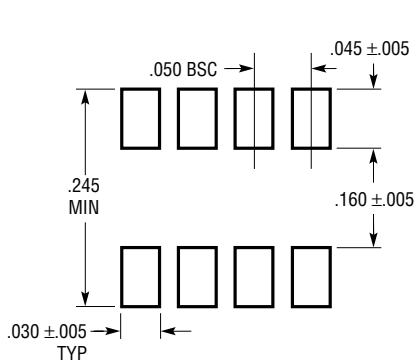

RECOMMENDED SOLDER PAD LAYOUT

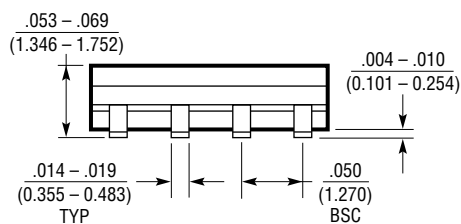
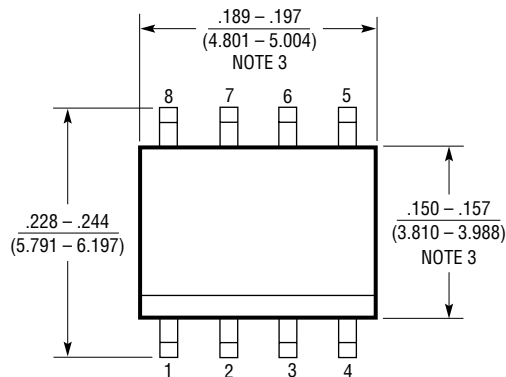

- NOTE:
 1. DIMENSIONS IN INCHES
 (MILLIMETERS)
 2. DRAWING NOT TO SCALE
 3. THESE DIMENSIONS DO NOT INCLUDE MOLD FLASH OR PROTRUSIONS.
 MOLD FLASH OR PROTRUSIONS SHALL NOT EXCEED $.006$ " (0.15mm)

S08 0303

PACKAGE DESCRIPTION

N Package
14-Lead PDIP (Narrow 0.300)
(LTC DWG # 05-08-1510)

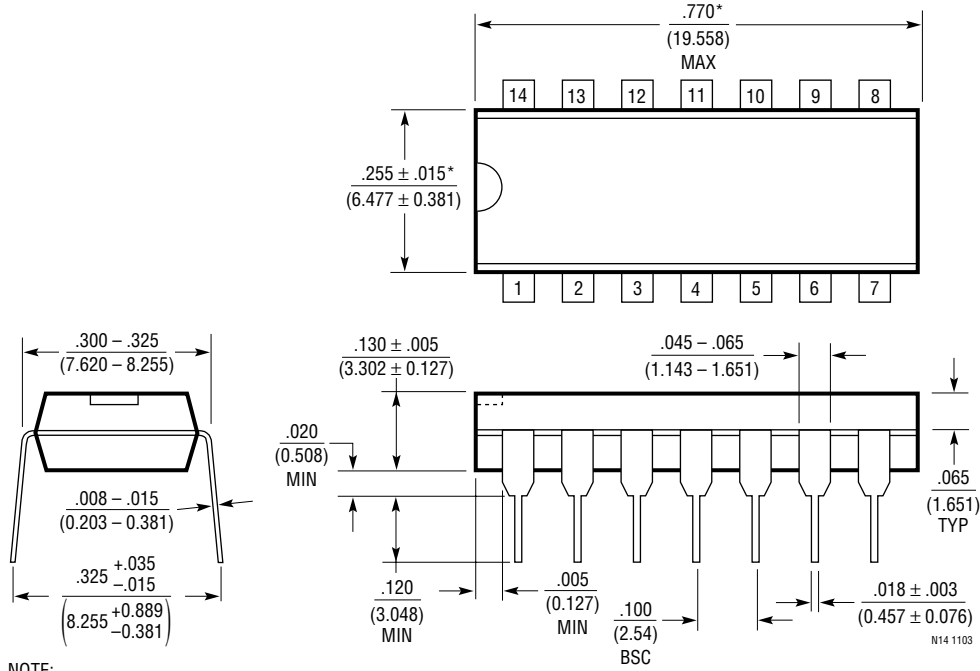

NOTE:
1. DIMENSIONS ARE $\frac{\text{INCHES}}{\text{MILLIMETERS}}$
*THESE DIMENSIONS DO NOT INCLUDE MOLD FLASH OR PROTRUSIONS.
MOLD FLASH OR PROTRUSIONS SHALL NOT EXCEED .010 INCH (0.254mm)

PACKAGE DESCRIPTION

S Package
14-Lead Plastic Small Outline (Narrow 0.150)
(LTC DWG # 05-08-1610)

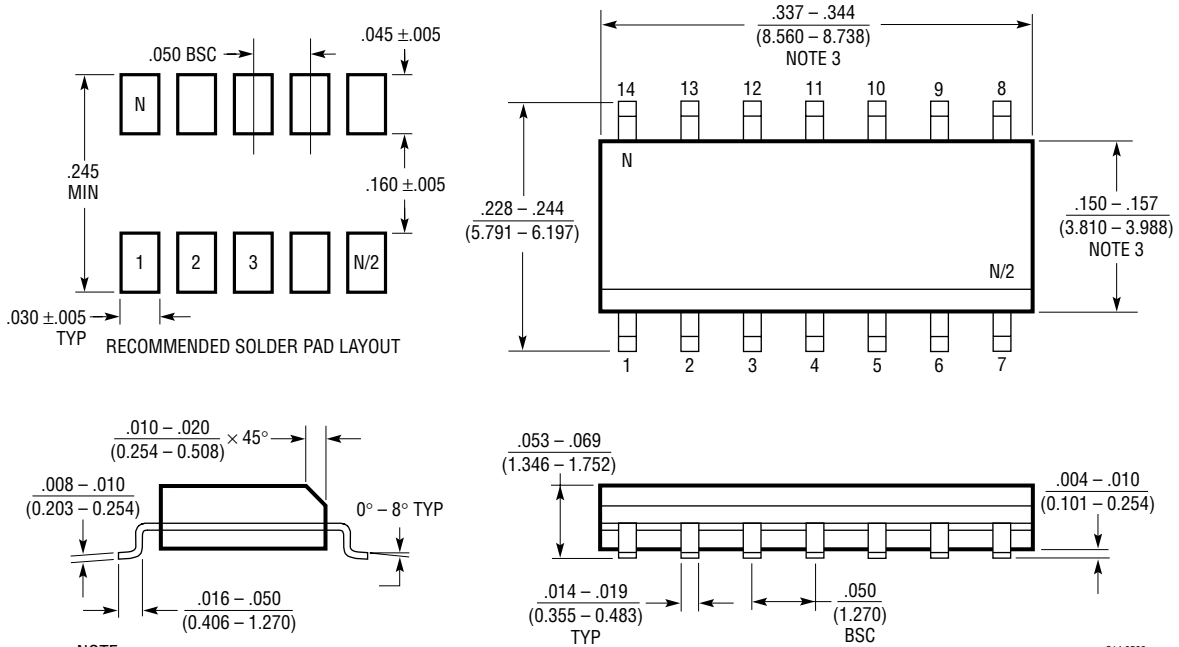

- NOTE:
1. DIMENSIONS IN $\frac{\text{INCHES}}{\text{MILLIMETERS}}$
 2. DRAWING NOT TO SCALE
 3. THESE DIMENSIONS DO NOT INCLUDE MOLD FLASH OR PROTRUSIONS.
MOLD FLASH OR PROTRUSIONS SHALL NOT EXCEED $.006$ " (0.15mm)

S14 0502

REVISION HISTORY (Revision history begins at Rev D)

| REV | DATE | DESCRIPTION | PAGE NUMBER |
|-----|-------|--------------------------------|-------------|
| D | 03/15 | Added notes to Function Tables | 9 |

LT1785/LT1785A/ LT1791/LT1791A

TYPICAL APPLICATION

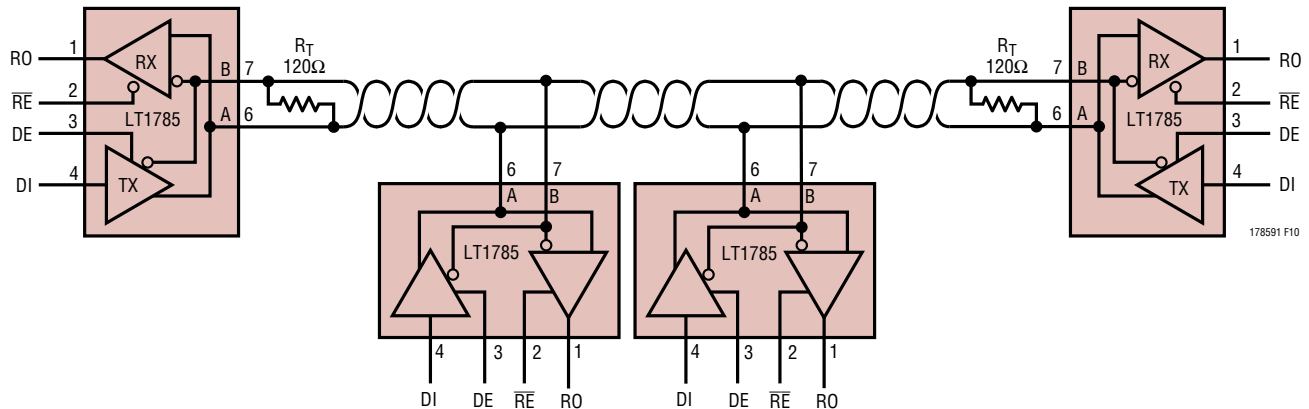

Figure 10. Half-Duplex RS485 Network Operation

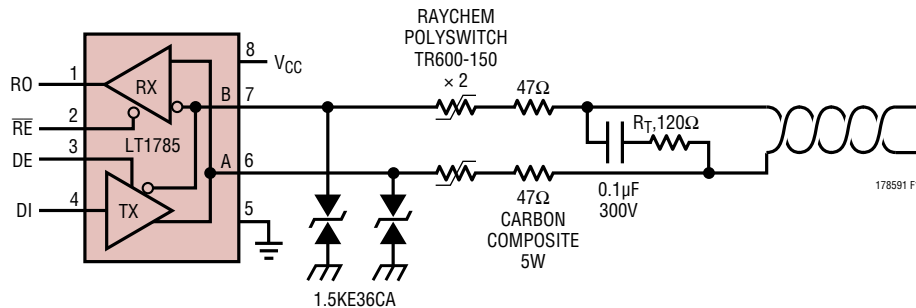

Figure 11. RS485 Network with 120V AC Line Fault Protection

RELATED PARTS

| PART NUMBER | DESCRIPTION | COMMENTS |
|---|---|--|
| LTC2854/LTC2855 | 3.3V 20Mbps RS485/RS422 Transceivers with Integrated Switchable Termination | Up to ±25kV HBM ESD, 125°C Operation |
| LTC2856/LTC2857/LTC2858 | 5V 20Mbps and Slew Rate Limited 15kV RS485/RS422 Transceivers | ±15kV ESD, 125°C Operation |
| LTC2850/LTC2851/LTC2852 | 3.3V 20Mbps RS485/RS422 Transceivers | ±15kV ESD, 125°C Operation |
| LTC2859/LTC2861 | 20Mbps RS485 Transceivers with Integrated Switchable Termination | Integrated, Switchable, 120Ω Termination Resistor, ±15kV ESD |
| LTC2862/LTC2863/LTC2864/LTC2865 | ±60V Fault Protected 3V to 5.5V RS485/RS422 Transceivers | 20Mbps or 250kbps, ±15kV HBM ESD, ±25V Common Mode Range |
| LTM2881 | Complete 3.3V Isolated RS485/RS422 μModule® Transceiver + Power | 2500V _{RMS} Isolation with Integrated Isolated DC/DC Converter and Switchable Termination |

178591fd

Looking for pricing, stock, or lifecycle information?

Click below to explore more details on WIN SOURCE:

 [View LT1785HS8#PBF on WIN SOURCE](#)

 [Linear Technology](#) Information

Optimize Your Supply Chain with WIN SOURCE Solutions

-  Global Sourcing Solution
-  Obsolete Management
-  Cost Control Management
-  Shortage Management
-  Alternative Solution
-  Excess Inventory Management