



**THE DATASHEET OF  
LTC3203EDD-1#PBF**



**500mA Output Current**  
**Low Noise Dual Mode**  
**Step-Up Charge Pumps**
**FEATURES**

- **Selectable Dual Mode Operation: 1:1.5 or 1:2**
- **High Output Current: Up to 500mA**
- **Low Noise Constant Frequency (1MHz/0.9MHz) Operation\***
- **V<sub>IN</sub> Range: 2.7V to 5.5V**
- Adjustable Output Voltage (LTC3203/LTC3203B)
- User Selectable Fixed Output Voltages: 4.5V or 5V (LTC3203-1 and LTC3203B-1)
- Burst Mode<sup>®</sup> Operation with I<sub>Q</sub> ~ 120μA (LTC3203/LTC3203-1)
- Constant Frequency Operation at All Loads (LTC3203B/LTC3203B-1)
- Soft-Start Limits Inrush Current at Turn-On
- Short-Circuit/Thermal Protection
- Shutdown Disconnects Load from Input
- Shutdown Current: < 1μA
- Available in a 10-pin (3mm × 3mm) DFN Package

**APPLICATIONS**

- High Current LED Backlight Supply for Cellphones/PDAs
- Cellphone Camera Light Supply
- General Purpose 3.3V or Li-Ion to 5V Supply
- USB ON THE GO(OTG) Devices

**DESCRIPTION**

The LTC<sup>®</sup>3203/LTC3203-1/LTC3203B/LTC3203B-1 are low noise, high efficiency charge pump DC/DC converters capable of driving loads up to 500mA from a 2.7V to 5.5V input. Low external parts count (two flying capacitors and bypass capacitors at V<sub>IN</sub> and V<sub>OUT</sub>) make the LTC3203 family ideally suited for small, battery-powered applications.

Built-in soft-start circuitry prevents excessive inrush current during start-up. High switching frequency enables the use of small external capacitors. The LTC3203/LTC3203-1 feature Burst Mode operation at light load to achieve high efficiency whereas the LTC3203B/LTC3203B-1 operate at constant frequency to achieve lowest noise operation.

The LTC3203-1/LTC3203B-1 have a user selectable fixed output voltage of 4.5V or 5V to power LEDs or logic circuits. The FB pin of the LTC3203/LTC3203B can be used to program the desired output voltage. The parts are short-circuit and overtemperature protected and are available in a low profile (3mm × 3mm) DFN package.

LT, LT, LTC and LTM are registered trademarks of Linear Technology Corporation. Burst Mode is a registered trademark of Linear Technology Corporation. All other trademarks are the property of their respective owners. \*Protected by U.S. Patents including 6411531.

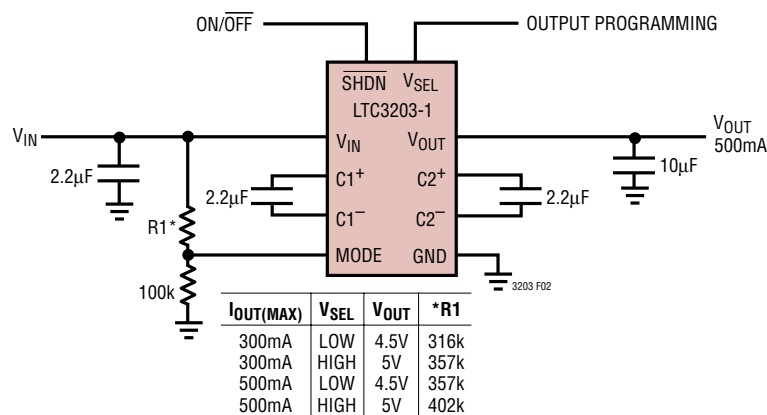
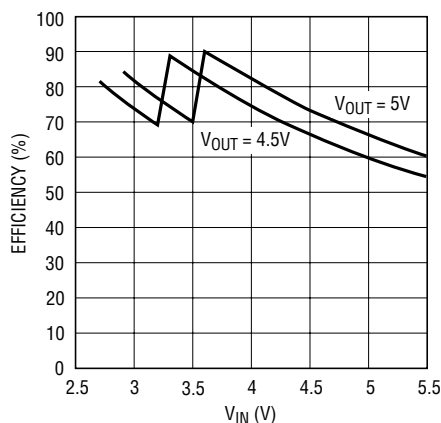
**TYPICAL APPLICATION**

**Efficiency vs V<sub>IN</sub> at 300mA Load Current**

3203 G05
32031fa

# LTC3203/LTC3203-1

# LTC3203B/LTC3203B-1

## ABSOLUTE MAXIMUM RATINGS

(Note 1)

$V_{IN}$ , $V_{OUT}$ to GND .....	-0.3V to 6V
MODE, $V_{SEL}/FB$ , SHDN .....	-0.3V to $V_{IN} + 0.3V$
$V_{OUT}$ Short Circuit Duration .....	Indefinite
$I_{OUT}$ (Note 2) .....	500mA
Operating Temperature Range (Note 3) ...	-40°C to 85°C
Storage Temperature Range .....	-65°C to 125°C

## PACKAGE/ORDER INFORMATION

TOP VIEW

DD PACKAGE  
10-LEAD (3mm × 3mm) PLASTIC DFN  
 $T_{JMAX} = 125^{\circ}C, \theta_{JA} = 44^{\circ}C/W, \theta_{JC} = 3^{\circ}C/W$   
EXPOSED PAD (PIN 11) IS GND, MUST BE SOLDERED TO PCB  
\* $V_{SEL}$  ON LTC3203-1/LTC3203B-1. FB ON LTC3203/LTC3203B

ORDER PART NUMBER	DD PART MARKING
LTC3203EDD	LBQK
LTC3203EDD-1	LCFH
LTC3203BEDD-1	LCGY
LTC3203BEDD	LCGX

**Order Options** Tape and Reel: Add #TR  
Lead Free: Add #PBF Lead Free Tape and Reel: Add #TRPBF  
Lead Free Part Marking: <http://www.linear.com/leadfree/>

Consult LTC Marketing for parts specified with wider operating temperature ranges.

## ELECTRICAL CHARACTERISTICS

The ● denotes specifications which apply over the full specified temperature range, otherwise specifications are at 25°C.  $V_{IN} = 3.6V$ ,  $C1 = C2 = 2.2\mu F$  unless otherwise specified.

SYMBOL	PARAMETER	CONDITIONS	MIN	TYP	MAX	UNITS
<b>LTC3203/LTC3203-1/LTC3203B/LTC3203B-1</b>						
$V_{IN}$	Input Voltage Range		● 2.7		5.5	V
$I_{SHDN}$	Shutdown Current	$SHDN = 0V, V_{OUT} = 0V$	●		1	$\mu A$
$R_{OL}$	Open Loop Output Impedance	2x Mode (Note 4), $V_{IN} = 2.7V, V_{OUT} = 4.5V$ 1.5x Mode (Note 4), $V_{IN} = 3.6V, V_{OUT} = 4.5V$		2.0 1.5	3.0 2.6	$\Omega$ $\Omega$
$f_{OSC}$	CLK Frequency	Oscillator Free Running, 2x Mode Oscillator Free Running, 1.5x Mode		1.0 0.9		MHz MHz
$V_{MODEH}$	MODE Input High Voltage		● 0.874	0.91	0.946	V
$V_{MODEL}$	MODE Input Low Voltage		● 0.788	0.82	0.852	V
$V_{SHDNH}$	SHDN Input High Voltage		● 1.3			V
$V_{SHDNL}$	SHDN Input Low Voltage		●		0.4	V
$I_{MODEH}$	MODE Input High Current		● -1		1	$\mu A$
$I_{MODEL}$	MODE Input Low Current		● -1		1	$\mu A$
$I_{SHDNH}$	SHDN Input High Current		● -1		1	$\mu A$
$I_{SHDNL}$	SHDN Input Low Current		● -1		1	$\mu A$

32031fa

**ELECTRICAL CHARACTERISTICS** The ● denotes specifications which apply over the full specified temperature range, otherwise specifications are at 25°C.  $V_{IN} = 3.6V$ ,  $C1 = C2 = 2.2\mu F$  unless otherwise specified.

SYMBOL	PARAMETER	CONDITIONS	MIN	TYP	MAX	UNITS	
<b>LTC3203-1/LTC3203B-1</b>							
$V_{OUT}$	4.5V Output Voltage Range ( $V_{SEL} = 0V$ ) (Note 5)	$V_{IN} > 3.1V$ , $I_{OUT} < 500mA$	●	4.32	4.5	4.68	V
		$V_{IN} > 2.9V$ , $I_{OUT} < 350mA$	●	4.32	4.5	4.68	V
		$V_{IN} > 2.7V$ , $I_{OUT} < 250mA$	●	4.32	4.5	4.68	V
$V_{OUT}$	5V Output Voltage Range ( $V_{SEL} = V_{IN}$ ) (Note 5)	$V_{IN} > 3.1V$ , $I_{OUT} < 500mA$	●	4.8	5	5.2	V
		$V_{IN} > 3.1V$ , $I_{OUT} < 400mA$	●	4.8	5	5.2	V
		$V_{IN} > 2.7V$ , $I_{OUT} < 150mA$	●	4.8	5	5.2	V
$\Delta V_{OUT}/\Delta I_{OUT}$	$V_{OUT}$ Load Regulation	$V_{IN} = 3.6V$ , $I_{OUT} = 100mA$ to 500mA, 2x Mode, $V_{IN} = 4V$ , $I_{OUT} = 100mA$ to 500mA, 1.5x Mode		0.37 0.27		mV/mA mV/mA	
$I_{CC}$	No Load Operating Current (LTC3203-1)	$I_{OUT} = 0mA$ , 2x Mode $I_{OUT} = 0mA$ , 1.5x Mode		120 100	300 300	$\mu A$ $\mu A$	
	No Load Operating Current (LTC3203B-1)	$I_{OUT} = 0mA$ , 2x Mode $I_{OUT} = 0mA$ , 1.5x Mode		9 7		mA mA	
$V_{SELH}$	$V_{SEL}$ Input High Voltage		●	1.3		V	
$V_{SELL}$	$V_{SEL}$ Input Low Voltage		●		0.4	V	
$I_{SELH}$	$V_{SEL}$ Input High Current		●	-1	1	$\mu A$	
$I_{SELL}$	$V_{SEL}$ Input Low Current		●	-1	1	$\mu A$	
<b>LTC3203/LTC3203B</b>							
$V_{FB}$	Feedback Servo Voltage	$I_{OUT} = 0mA$ , $2.7V \leq V_{IN} \leq 5.5V$	●	0.88	0.91	0.94	V
$I_{FB}$	FB Input Current	$V_{FB} = 0.95V$	●	-50		50	nA
$\Delta V_{FB}/\Delta I_{OUT}$	Load Regulation (Refer to FB Pin)	$I_{OUT} = 100mA$ to 500mA, 2x Mode, $V_{IN} = 3.6V$			0.08		mV/mA
		$I_{OUT} = 100mA$ to 500mA, 1.5x Mode, $V_{IN} = 4V$			0.06		mV/mA
$I_{CC}$	No Load Operating Current (LTC3203)	$I_{OUT} = 0mA$ , 2x Mode, 5V $V_{OUT}$ Setting $I_{OUT} = 0mA$ , 1.5x Mode, 5V $V_{OUT}$ Setting		120 100	300 300	$\mu A$ $\mu A$	
	No Load Operating Current (LTC3203B)	$I_{OUT} = 0mA$ , 2x Mode, 5V $V_{OUT}$ Setting $I_{OUT} = 0mA$ , 1.5x Mode, 5V $V_{OUT}$ Setting		9 7		mA mA	

**Note 1:** Stresses beyond those listed under Absolute Maximum Ratings may cause permanent damage to the device. Exposure to any Absolute Maximum Rating condition for extended periods may affect device reliability and lifetime.

**Note 2:** Based on long-term current density limitations.

**Note 3:** The LTC3203/LTC3203-1/LTC3203B/LTC3203B-1 are guaranteed to meet performance specifications from 0°C to 85°C. Specifications over the -40°C to 85°C operating temperature range are assured by design, characterization and correlation with statistical process controls.

**Note 4:** Output not in regulation (based on wafer sort):

$$R_{OL} \equiv (2 \bullet V_{IN} - V_{OUT})/I_{OUT}, 2x \text{ Mode}$$

$$R_{OL} \equiv (1.5 \bullet V_{IN} - V_{OUT})/I_{OUT}, 1.5x \text{ Mode}$$

**Note 5:** Proper conversion mode, 1.5x or 2x, has to be chosen based on  $R_{OL}$  to ensure output regulation.

# LTC3203/LTC3203-1

# LTC3203B/LTC3203B-1

## TYPICAL PERFORMANCE CHARACTERISTICS

$T_A = 25^\circ\text{C}$ ,  $V_{IN} = 3.6\text{V}$ ,  $C_1 = C_2 = 2.2\mu\text{F}$  unless otherwise specified

**$V_{OUT}$  vs Load Current  
(4.5V Output Setting)**

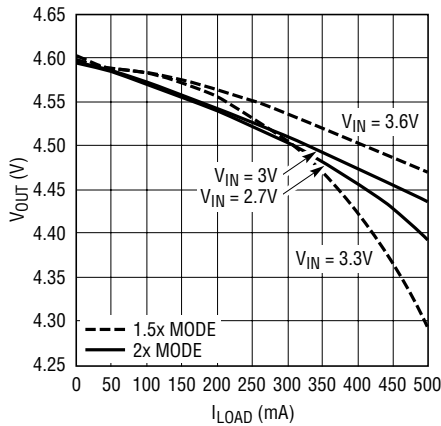

3203 G01

**$V_{OUT}$  vs Load Current  
(5V Output Setting)**

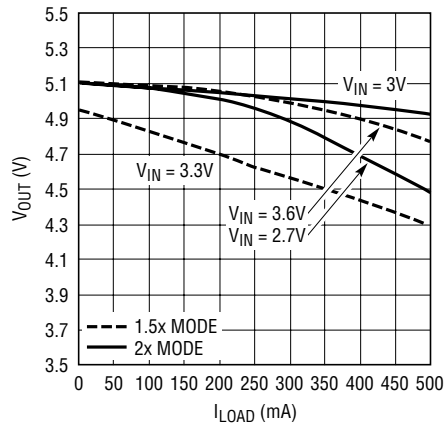

3203 G02

**$V_{OUT}$  vs Supply Voltage  
(4.5V Output Setting)**

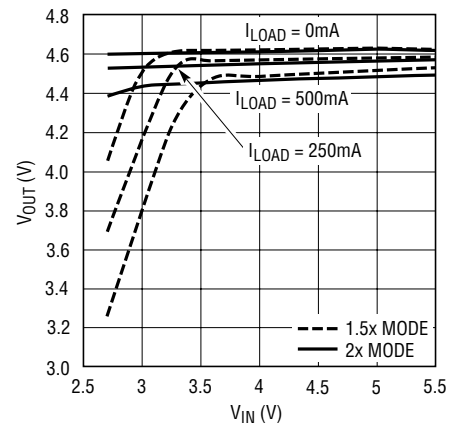

3203 G03

**$V_{OUT}$  vs Supply Voltage  
(5V Output Setting)**

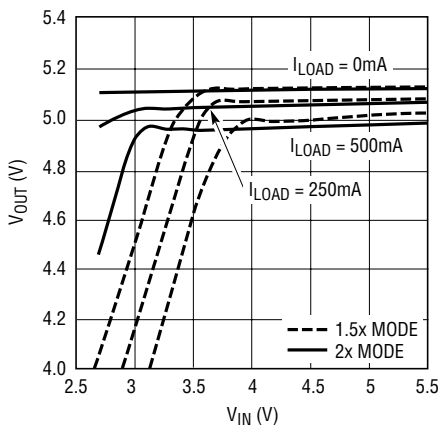

3203 G04

**Open-Loop Output Resistance  
vs Temperature**

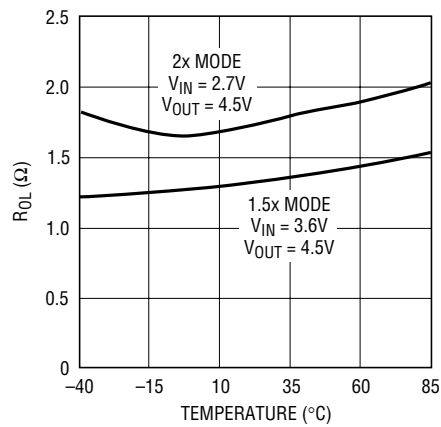

3203 G06

**Oscillator Frequency  
vs Supply Voltage**

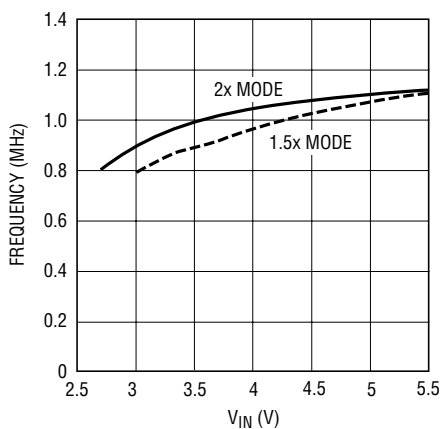

3203 G07

**Short-Circuit Current  
vs Supply Voltage**

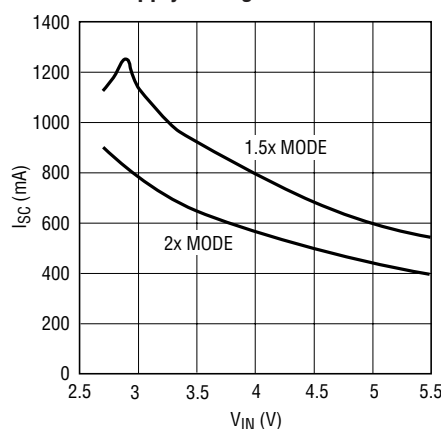

3203 G08

32031fa

## TYPICAL PERFORMANCE CHARACTERISTICS

No-Load Input Current vs Supply Voltage (LTC3203/LTC3203-1)

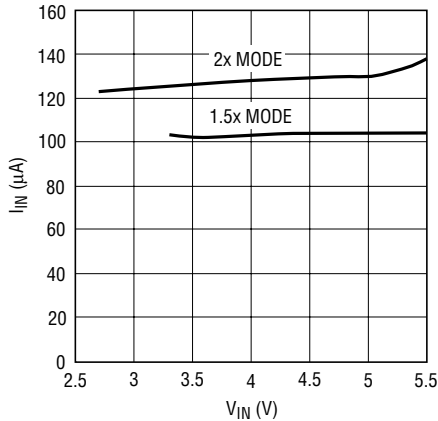

Burst Mode Current Threshold vs Supply Voltage (LTC3203/LTC3203-1)

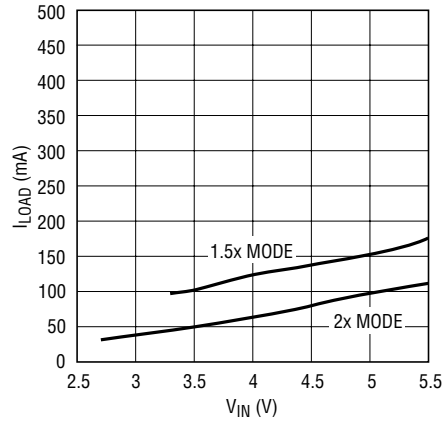

Extra Input Current vs Load Current (LTC3203/LTC3203-1)

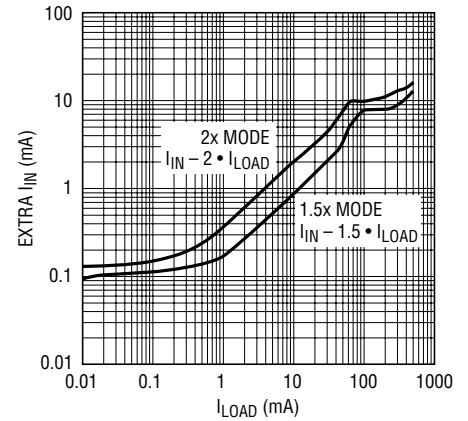

Input and Output Ripple (1.5x Mode)

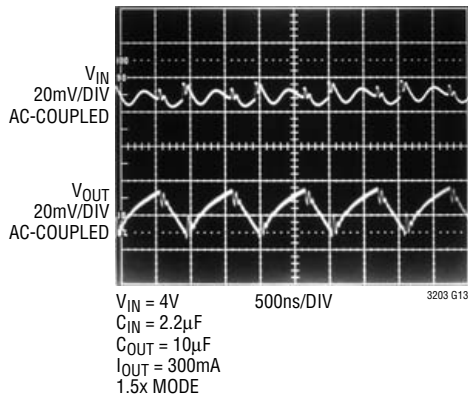

Input and Output Ripple (2x Mode)

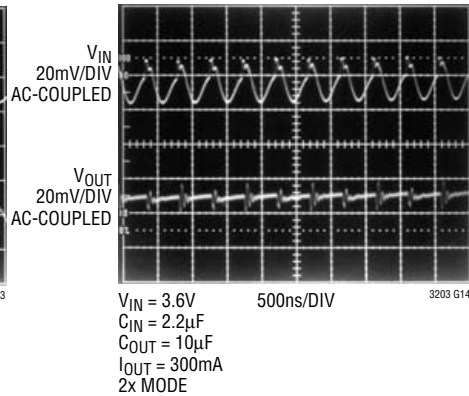

Load Transient (1.5x Mode)

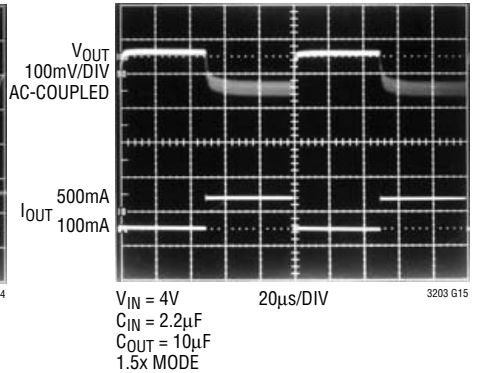

Load Transient (2x Mode)

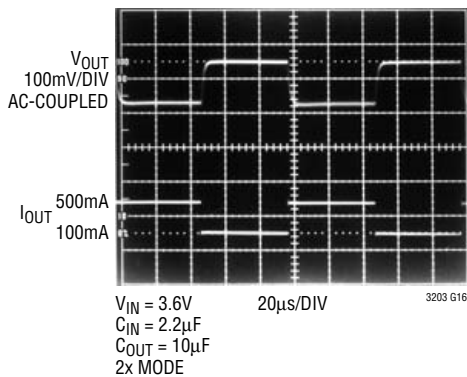

$V_{FB}$  Set Point vs Supply Voltage (LTC3203/LTC3203B)

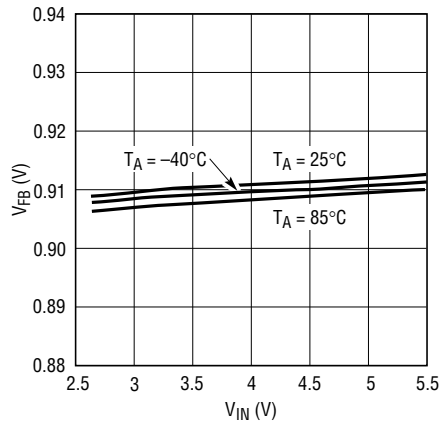

$V_{FB}$  vs Load Current (LTC3203/LTC3202B)

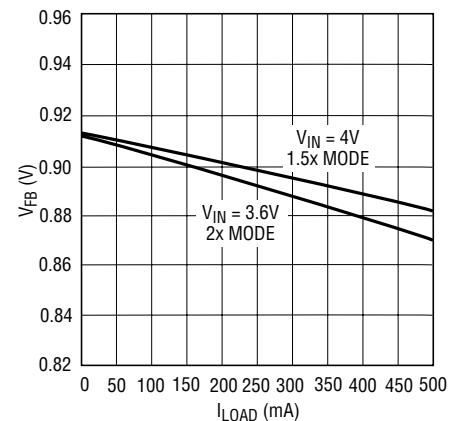

## PIN FUNCTIONS

**C2<sup>+</sup> (Pin 1):** Flying Capacitor 2 Positive Terminal (C2).

**V<sub>OUT</sub> (Pin 2):** Regulated Output Voltage. V<sub>OUT</sub> should be bypassed with a low ESR ceramic capacitor as close to the pin as possible for best performance. The capacitor should have greater than 4.7μF capacitance under all conditions.

**C1<sup>+</sup> (Pin 3):** Flying Capacitor 1 Positive Terminal (C1).

**SHDN (Pin 4):** Active Low Shutdown Input. A low on SHDN puts the LTC3203/LTC3203-1/LTC3203B/LTC3203B-1 in low current shutdown mode. Do not float the SHDN pin.

**V<sub>SEL</sub> (Pin 5) (LTC3203-1/LTC3203B-1):** Output Voltage Selection Input. A logic 0 at V<sub>SEL</sub> sets the regulated V<sub>OUT</sub> to 4.5V; and a logic 1 sets the regulated V<sub>OUT</sub> to 5V. Do not float the V<sub>SEL</sub> pin.

**FB (Pin 5) (LTC3203/LTC3203B):** Feedback. The voltage on this pin is compared to the internal reference voltage (0.91V) by the error amplifier to keep the output in regulation. An external resistor divider is required between V<sub>OUT</sub> and FB to program the output voltage.

**MODE (Pin 6):** Mode Selection Input. The LTC3203/LTC3203-1/LTC3203B/LTC3203B-1 operates in 1.5x mode if the MODE pin is greater than V<sub>MODEH</sub>, which gives higher charge pump efficiency. If the MODE pin is less than V<sub>MODEL</sub>, the LTC3203/LTC3203-1/LTC3203B/LTC3203B-1 operates in 2x mode, which gives a higher charge pump boost voltage.

**V<sub>IN</sub> (Pin 7):** Input Supply Voltage. V<sub>IN</sub> should be bypassed with a more than 2.2μF low ESR ceramic capacitor to GND.

**C2<sup>-</sup> (Pin 8):** Flying Capacitor 2 Negative Terminal (C2).

**GND (Pin 9):** Ground. This pin should be connected directly to a low impedance ground plane.

**C1<sup>-</sup> (Pin 10):** Flying Capacitor 1 Negative Terminal (C1).

**Exposed Pad (Pin 11):** Ground. This pin must be soldered to the PCB for electrical contact and rated thermal performance.



## OPERATION

The LTC3203/LTC3203-1/LTC3203B/LTC3203B-1 use a switched capacitor charge pump to boost  $V_{IN}$  to a regulated output voltage. Regulation is achieved by sensing the output voltage through a resistor divider and modulating the charge pump output current based on the error signal. A two-phase non-overlapping clock activates the charge pump switches. The typical frequency of charging and discharging the flying capacitors is 1MHz (2x mode) or 0.9MHz (1.5x mode). A unique architecture maintains relatively constant input current for the lowest possible input noise.

### Mode of Operation

The LTC3203/LTC3203-1/LTC3203B/LTC3203B-1 charge pump can operate in two modes of voltage conversion: 1.5x or 2x.

In the 1.5x mode the flying capacitors are charged in series during the first clock phase, and stacked in parallel on top of  $V_{IN}$  on the second clock phase. Alternatively, in the 2x mode the flying capacitors are charged on alternate clock phases from  $V_{IN}$ . While one capacitor is being charged from  $V_{IN}$ , the other is stacked on top of  $V_{IN}$  and connected to the output. The two flying capacitors operate out of phase to minimize both input and output ripple. At light load the LTC3203/LTC3203-1 go into Burst Mode operation to reduce quiescent current.

The conversion mode should be chosen based on considerations of efficiency, available output current and  $V_{OUT}$  ripple. With a given  $V_{IN}$ , the 1.5x mode gives a higher efficiency but lower available output current. The 2x mode gives a higher available output current but lower efficiency. Moreover, the output voltage ripple in the 2x mode is lower due to the out-of-phase operation of the two flying capacitors.

Generally, at low  $V_{IN}$ , the 2x mode should be selected, and at higher  $V_{IN}$ , the 1.5x mode should be selected. By connecting a resistive divider from  $V_{IN}$  to the MODE input

pin the MODE input allows the user to accurately program the  $V_{IN}$  threshold at which the charge pump will switch from 1.5x mode to 2x mode when  $V_{IN}$  starts to fall and vice versa. Hysteresis on the MODE pin prevents the LTC3203/LTC3203-1/LTC3203B/LTC3203B-1 from switching continuously between the two modes.

### Output Voltage Programming

The LTC3203-1/LTC3203B-1 has a  $V_{SEL}$  input pin that allows the user to program the regulated output voltage to either 4.5V or 5V. 4.5V  $V_{OUT}$  is useful for driving white LEDs while a regulated  $V_{OUT}$  of 5V is useful for powering logic circuits.

The LTC3203/LTC3203B has a FB pin in place of the  $V_{SEL}$  pin that allows the output voltage to be programmed using an external resistive divider.

### Shutdown Mode

When  $\overline{SHDN}$  is asserted low, the LTC3203/LTC3203-1/LTC3203B/LTC3203B-1 enter shutdown mode. The charge pump is first disabled, but the LTC3203/LTC3203-1/LTC3203B/LTC3203B-1 continue to draw 5 $\mu$ A of supply current. This current will drop to less than 1 $\mu$ A when  $V_{OUT}$  is fully discharged to 0V. Furthermore,  $V_{OUT}$  is disconnected from  $V_{IN}$ . Since the  $\overline{SHDN}$  pin is a high impedance CMOS input, it should never be allowed to float.

### Burst Mode Operation

The LTC3203/LTC3203-1 provide automatic Burst Mode operation to reduce quiescent current of the power converter at light loads. Burst Mode operation is initiated if the output load current falls below an internally programmed threshold. Once Burst Mode operation is initiated, the part shuts down the internal oscillator to reduce the switching losses and goes into a low current state. This state is referred to as the Sleep state in which the chip consumes only about 120 $\mu$ A from the input.

## OPERATION

When the output voltage drops enough to overcome the burst comparator hysteresis, the part wakes up and commences normal fixed frequency operation. The output capacitor recharges and causes the part to re-enter the Sleep state if the output load still remains less than the Burst Mode threshold. This Burst Mode threshold varies with  $V_{IN}$ ,  $V_{OUT}$  and the choice of output storage capacitor.

### Short-Circuit/Thermal Protection

The LTC3203/LTC3203-1/LTC3203B/LTC3203B-1 have built-in short-circuit current limit as well as over-temperature protection. During a short-circuit condition, the chip will automatically limit the output current to approximately 1A. At higher temperatures, or if the input voltage is high enough to cause excessive self-heating of the part, the

thermal shutdown circuitry will shut down the charge pump once the junction temperature exceeds approximately 150°C. It will enable the charge pump once the junction temperature drops back to approximately 135°C. The LTC3203/LTC3203-1/LTC3203B/LTC3203B-1 will cycle in and out of thermal shutdown indefinitely without latch-up or damage until the short circuit condition on  $V_{OUT}$  is removed.

### Soft-Start

To prevent excessive current flow at  $V_{IN}$  during start-up, the LTC3203/LTC3203-1/LTC3203B/LTC3203B-1 have built-in soft-start circuitry. Soft-start is achieved by increasing the amount of current available to the output charge storage capacitor linearly over a period of approximately 250 $\mu$ s.

## APPLICATIONS INFORMATION

### Power Efficiency

The power efficiency ( $\eta$ ) of the LTC3203/LTC3203-1/LTC3203B/LTC3203B-1 in 1.5x mode is similar to that of a linear regulator with an effective input voltage of 1.5 times the actual input voltage. This occurs because the input current for a 1.5x fractional charge pump is approximately 1.5 times the load current. In an ideal regulating 1.5x charge pump the power efficiency would be given by:

$$\eta_{1.5X\text{Ideal}} = \frac{P_{\text{OUT}}}{P_{\text{IN}}} = \frac{V_{\text{OUT}} \cdot I_{\text{OUT}}}{V_{\text{IN}} \cdot 1.5I_{\text{OUT}}} = \frac{V_{\text{OUT}}}{1.5V_{\text{IN}}}$$

Similarly, in 2x mode, the efficiency is similar to that of a linear regulator with an effective input voltage of twice the actual input voltage. In an ideal regulating voltage doubler the power efficiency would be given by:

$$\eta_{2X\text{Ideal}} = \frac{P_{\text{OUT}}}{P_{\text{IN}}} = \frac{V_{\text{OUT}} \cdot I_{\text{OUT}}}{V_{\text{IN}} \cdot 2I_{\text{OUT}}} = \frac{V_{\text{OUT}}}{2V_{\text{IN}}}$$

At moderate to high output power the switching losses and quiescent current of the LTC3203/LTC3203-1/LTC3203B/LTC3203B-1 are negligible and the expression above is valid.

As evident from the above two equations, with the same  $V_{\text{IN}}$ , the 1.5x mode will give higher efficiency than the 2x mode.

### Programming the LTC3203/LTC3203B Output Voltage (FB Pin)

While the LTC3203-1/LTC3203B-1 have internal resistive dividers to program the output voltage, the programmable LTC3203/LTC3203B may be set to an arbitrary voltage via an external resistive divider. Since it operates as a voltage doubling charge pump when MODE is less than  $V_{\text{MODEL}}$ , it is not possible to achieve output voltages greater than twice the available input voltage in this case. Similarly, when MODE is greater than  $V_{\text{MODEH}}$ , the achievable output voltage is less than 1.5 times the available input voltage. Figure 1 shows the required voltage divider connection.

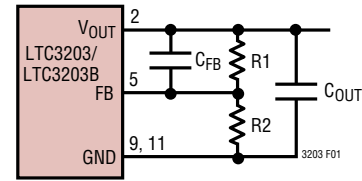

Figure 1. Programming the LTC3203/LTC3203B Output Voltage

The voltage divider ratio is given by the expression:

$$\frac{R1}{R2} = \frac{V_{\text{OUT}}}{0.91V} - 1 \text{ or } V_{\text{OUT}} = \left( \frac{R1}{R2} + 1 \right) \cdot 0.91V$$

Typical values for total voltage divider resistance can range from several  $k\Omega$ s up to  $1M\Omega$ . The compensation capacitor ( $C_{\text{FB}}$ ) is necessary to counteract the pole caused by the large valued resistors R1 and R2, and the input capacitance of the FB pin. For best results,  $C_{\text{FB}}$  should be 5pF for all R1 or R2 greater than 10k and can be omitted if both R1 and R2 are less than 10k.

The LTC3203/LTC3203B can also be configured to control a current. In white LED applications the LED current is programmed by the ratio of the feedback set point voltage and a sense resistor as shown in Figure 2. The current of the remaining LEDs is controlled by virtue of their similarity to the reference LED and the ballast voltage across the sense resistor.

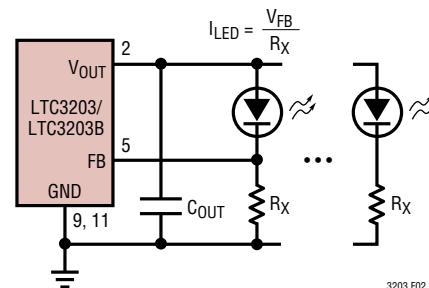

Figure 2. Programming the LTC3203/LTC3203B Output Current

In this configuration the feedback factor ( $\Delta V_{\text{OUT}}/\Delta I_{\text{OUT}}$ ) will be very near unity since the small signal LED impedance will be considerably less than the current setting

## APPLICATIONS INFORMATION

resistor  $R_X$ . Thus, this configuration will have the highest loop gain giving it the lowest closed-loop output resistance. Likewise it will also require the largest amount of output capacitance to preserve stability.

### Effective Open Loop Output Resistance ( $R_{OL}$ )

The effective open loop output resistance ( $R_{OL}$ ) of a charge pump is a very important parameter, which determines its strength. The value of this parameter depends on many factors such as the oscillator frequency ( $f_{OSC}$ ), the value of the flying capacitor ( $C_{FLY}$ ), the non-overlap time, the internal switch resistances ( $R_S$ ), and the ESR of the external capacitors.

### Maximum Available Output Current

Figure 3 shows how the LTC3203/LTC3203-1/LTC3203B/LTC3203B-1 can be modeled as a Thevenin-equivalent circuit.

Thus the maximum available output current and voltage can be calculated from the effective open-loop output resistance,  $R_{OL}$ , and the effective output voltage,  $1.5V_{IN}$  (in 1.5x mode) or  $2V_{IN}$  (in 2x mode). From Figure 3, the available current is given by:

$$I_{OUT} = \frac{1.5V_{IN} - V_{OUT}}{R_{OL}} \text{ In 1.5x mode}$$

$$I_{OUT} = \frac{2V_{IN} - V_{OUT}}{R_{OL}} \text{ In 2x mode}$$

As evident from the above two equations, with the same  $V_{IN}$  and  $R_{OL}$ , the 2x mode will give more output current than the 1.5x mode.

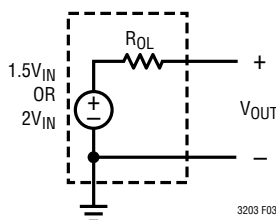

Figure 3. Charge Pump Open-Loop Thevenin-Equivalent Circuit

### Programming the MODE Pin

By connecting a resistor divider to the MODE pin, the  $V_{IN}$  voltage at which the chip switches modes can be accurately programmed.

When  $V_{IN}$  ramps up, the voltage at the MODE pin crosses  $V_{MODEH}$  and the chip switches from 2x mode to 1.5x mode. When  $V_{IN}$  starts to drop, the voltage at the MODE pin crosses  $V_{MODEL}$  and the chip switches back to 2x mode. The MODE pin resistor ratio must be selected such that at the switch point the output is still able to maintain regulation at maximum  $I_{OUT}$ :

$$1.5 \cdot V_{IN(1.5x)} - V_{OUT} > I_{OUT} \cdot R_{OL(1.5x)}$$

The minimum  $V_{IN}$  operating in 1.5x mode occurs at the switch point where:

$$V_{IN} = V_{MODEL} \cdot \left( \frac{R_{MODE1}}{R_{MODE2}} + 1 \right)$$

therefore:

$$1.5 \cdot V_{MODEL} \cdot \left( \frac{R_{MODE1}}{R_{MODE2}} + 1 \right)$$

$$> R_{OL(1.5x)(MAX)} \cdot I_{OUT(MAX)} + V_{OUT(MIN)}$$

$$\frac{R_{MODE1}}{R_{MODE2}} > \frac{V_{OUT(MIN)} + R_{OL(1.5x)(MAX)} \cdot I_{OUT(MAX)}}{1.5 \cdot V_{MODEL}} - 1$$

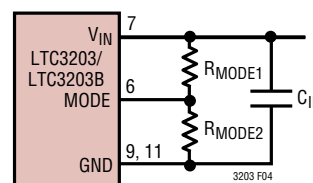

Figure 4

## APPLICATIONS INFORMATION

For the example given, a 5V output setting with  $\pm 4\%$  output tolerance and maximum load current of 500mA, a resistor ratio of:

$$\frac{R_{\text{MODE1}}}{R_{\text{MODE2}}} > 4$$

at the MODE pin allows the chip to switch modes while maintaining regulation.

### $V_{\text{IN}}$ , $V_{\text{OUT}}$ Capacitor Selection

The style and value of capacitors used with the LTC3203/LTC3203-1/LTC3203B/LTC3203B-1 determine several important parameters such as regulator control loop stability, output ripple, charge pump strength and minimum start-up time.

To reduce noise and ripple, it is recommended that low equivalent series resistance (ESR) multilayer ceramic chip capacitors (MLCCs) be used for both  $C_{\text{IN}}$  and  $C_{\text{OUT}}$ . Tantalum and aluminum capacitors are not recommended because of their high ESR.

In 1.5x mode, the value of  $C_{\text{OUT}}$  directly controls the amount of output ripple for a given load current. Increasing the size of  $C_{\text{OUT}}$  will reduce the output ripple at the expense of higher minimum turn-on time and higher start-up current. The peak-to-peak output ripple for 1.5x mode is given by the expression:

$$V_{\text{RIPPLE(P-P)}} = \frac{I_{\text{OUT}}}{3f_{\text{OSC}} \cdot C_{\text{OUT}}}$$

where  $f_{\text{OSC}}$  is the LTC3203/LTC3203-1/LTC3203B/LTC3203B-1's oscillator frequency (typically 0.9MHz) and  $C_{\text{OUT}}$  is the output charge storage capacitor.

In 2x mode, the output ripple is very low due to the out-of-phase operation of the two flying capacitors.  $V_{\text{OUT}}$  remains almost flat when either of the flying capacitors is connected to  $V_{\text{OUT}}$ .

Both the type and value of the output capacitor can significantly affect the stability of the LTC3203/LTC3203-1/LTC3203B/LTC3203B-1. As shown in the Block Diagram,

the LTC3203/LTC3203-1/LTC3203B/LTC3203B-1 use a control loop to adjust the strength of the charge pump to match the current required at the output. The error signal of this loop is stored directly on the output charge storage capacitor. The charge storage capacitor also serves to form the dominant pole for the control loop. To prevent ringing or instability, it is important for the output capacitor to maintain at least 4.7 $\mu\text{F}$  of capacitance over all conditions. Note that the actual capacitance of ceramic capacitors usually drops when biased with DC voltage. Different capacitor types drop to different extents. Make sure that the selected ceramic capacitors have enough capacitance when biased with the required DC voltage.

Likewise, excessive ESR on the output capacitor will tend to degrade the loop stability of the LTC3203/LTC3203-1/LTC3203B/LTC3203B-1. The closed-loop output resistance of the LTC3203/LTC3203-1/LTC3203B/LTC3203B-1 are designed to be 0.27 $\Omega$  (at 1.5x mode). For a 100mA load current change, the output voltage will change by about 27mV. If the output capacitor has 0.27 $\Omega$  or more of ESR, the closed-loop frequency response will cease to roll-off in a simple one-pole fashion and poor load transient response or instability could result. Multilayer ceramic chip capacitors typically have exceptional ESR performance and, combined with a good board layout, should yield very good stability and load transient performance. As the value of  $C_{\text{OUT}}$  controls the amount of output ripple, the value of  $C_{\text{IN}}$  controls the amount of ripple present at the input pin ( $V_{\text{IN}}$ ). The input current to the LTC3203/LTC3203-1/LTC3203B/LTC3203B-1 will be relatively constant while the charge pump is on either the input charging phase or the output charging phase but will drop to zero during the clock non-overlap times. Since the non-overlap time is small (~40ns) these missing "notches" will result in only a small perturbation on the input power supply line. Note that a higher ESR capacitor such as tantalum will have higher input noise by the amount of the input current change times the ESR. Therefore ceramic capacitors are again recommended for their exceptional ESR performance. Further input noise reduction can be achieved by powering the LTC3203/LTC3203-1/LTC3203B/LTC3203B-1 through a very small series inductor as shown in Figure 5.

## APPLICATIONS INFORMATION

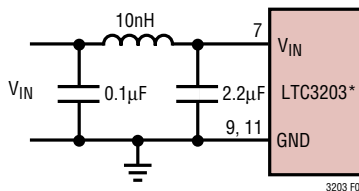

Figure 5. 10nH Inductor Used for Input Noise Reduction

A 10nH inductor will reject the fast current notches, thereby presenting a nearly constant current load to the input power supply. For economy the 10nH inductor can be fabricated on the PC board with about 1 cm (0.4") of PC board trace.

### Flying Capacitor Selection

*Warning: Polarized capacitors such as tantalum or aluminum should never be used for the flying capacitors since their voltage can reverse upon start-up of the LTC3203/LTC3203-1/LTC3203B/LTC3203B-1. Low ESR ceramic capacitors should always be used for the flying capacitors.*

The flying capacitors control the strength of the charge pump. In order to achieve the rated output current, it is necessary to have at least 2.2µF of capacitance for each of the flying capacitors.

Ceramic capacitors of different materials lose their capacitance with higher temperature and voltage at different rates. For example, a capacitor made of X7R material will retain most of its capacitance from  $-40^{\circ}\text{C}$  to  $85^{\circ}\text{C}$  whereas Z5U or Y5V style capacitors will lose considerable capacitance over that range. Z5U and Y5V capacitors may also have a poor voltage coefficient causing them to lose 60%

or more of their capacitance when the rated voltage is applied. Therefore, when comparing different capacitors, it is often more appropriate to compare the amount of achievable capacitance for a given case size rather than comparing the specified capacitance value. For example, over rated voltage and temperature conditions, a 4.7µF, 10V, Y5V ceramic capacitor in a 0805 case may not provide any more capacitance than a 1µF, 10V, X5R or X7R capacitor available in the same 0805 case. In fact, over bias and temperature range the 1µF, 10V, X5R or X7R will provide more capacitance than the 4.7µF, 10V, Y5V capacitor. The capacitor manufacturer's data sheet should be consulted to determine what value of capacitor is needed to ensure minimum capacitance values are met over operating temperature and bias voltage.

Below is a list of ceramic capacitor manufacturers and how to contact them:

AVX	<a href="http://www.avxcorp.com">www.avxcorp.com</a>
Kemet	<a href="http://www.kemet.com">www.kemet.com</a>
Murata	<a href="http://www.murata.com">www.murata.com</a>
Taiyo Yuden	<a href="http://www.t-yuden.com">www.t-yuden.com</a>
Vishay	<a href="http://www.vishay.com">www.vishay.com</a>
TDK	<a href="http://www.component.tdk.com">www.component.tdk.com</a>

## APPLICATIONS INFORMATION

### Thermal Management

For higher input voltages and maximum output current, there can be substantial power dissipation in the LTC3203/LTC3203-1/LTC3203B/LTC3203B-1. If the junction temperature increases above approximately 150°C, the thermal shutdown circuitry will automatically deactivate the output. To reduce the maximum junction temperature, a good thermal connection to the PC board is recommended. Connecting GND (Pin 9) and the exposed pad (Pin 11) of the DFN package to a ground plane under the device on two layers of the PC board can reduce the thermal resistance of the package and PC board considerably.

### Layout Considerations

Due to the high switching frequency and high transient currents produced by the LTC3203/LTC3203-1/LTC3203B/LTC3203B-1, careful board layout is necessary for optimum performance. A true ground plane and short connections to all the external capacitors will improve performance and ensure proper regulation under all conditions.

The flying capacitor pins C1<sup>+</sup>, C2<sup>+</sup>, C1<sup>-</sup> and C2<sup>-</sup> will have very high edge rate waveforms. The large dV/dt on these pins can couple energy capacitively to adjacent printed circuit board runs. Magnetic fields can also be generated

if the flying capacitors are not close to the part (i.e. the loop area is large). To decouple capacitive energy transfer, a Faraday shield may be used. This is a grounded PC trace between the sensitive node and the LTC3203/LTC3203-1/LTC3203B/LTC3203B-1 pins. For a high quality AC ground it should be returned to a solid ground plane that extends all the way to the LTC3203/LTC3203-1/LTC3203B/LTC3203B-1. To prevent degraded performance, the FB trace should be kept away or be shielded from the flying capacitor traces.

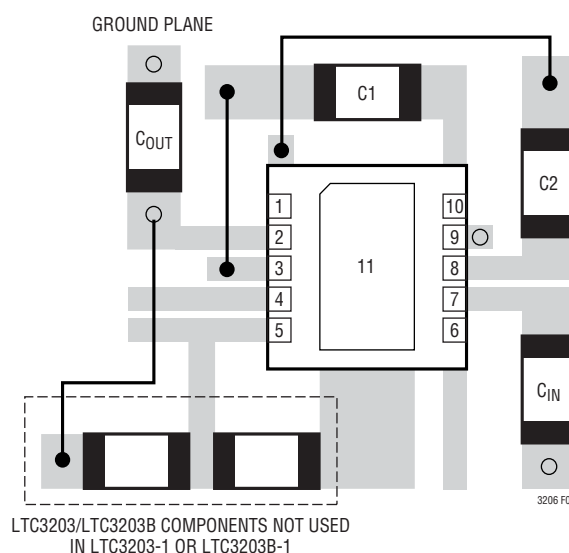
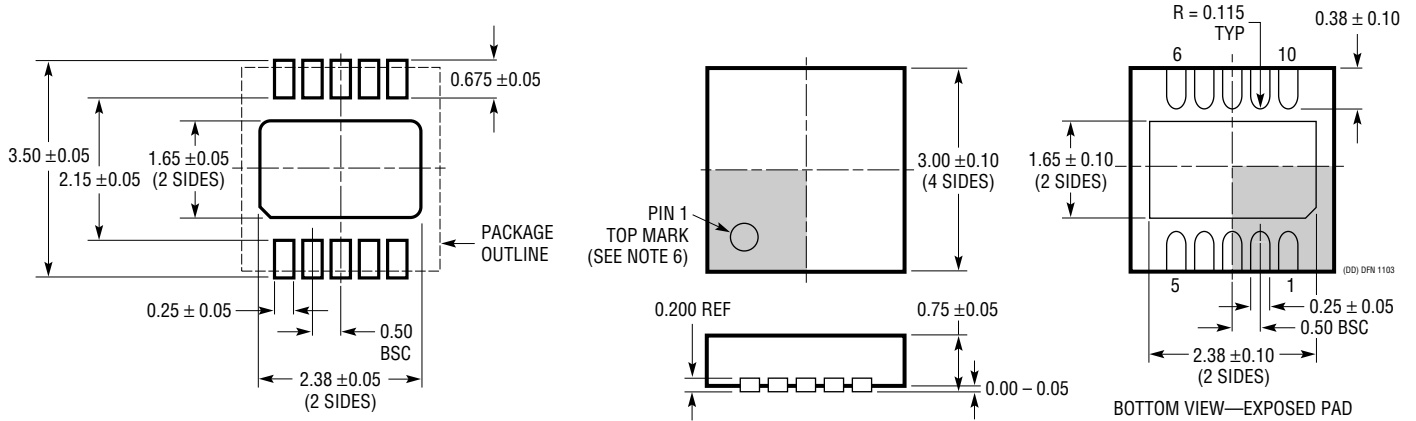

Figure 6. Recommended Layouts

## PACKAGE DESCRIPTION

**DD Package**  
**10-Lead Plastic DFN (3mm × 3mm)**  
(Reference LTC DWG # 05-08-1699)



**RECOMMENDED SOLDER PAD PITCH AND DIMENSIONS**

**NOTE:**

1. DRAWING TO BE MADE A JEDEC PACKAGE OUTLINE M0-229 VARIATION OF (WEED-2).  
CHECK THE LTC WEBSITE DATA SHEET FOR CURRENT STATUS OF VARIATION ASSIGNMENT
2. DRAWING NOT TO SCALE
3. ALL DIMENSIONS ARE IN MILLIMETERS
4. DIMENSIONS OF EXPOSED PAD ON BOTTOM OF PACKAGE DO NOT INCLUDE MOLD FLASH. MOLD FLASH, IF PRESENT, SHALL NOT EXCEED 0.15mm ON ANY SIDE
5. EXPOSED PAD SHALL BE SOLDER PLATED
6. SHADED AREA IS ONLY A REFERENCE FOR PIN 1 LOCATION ON THE TOP AND BOTTOM OF PACKAGE

# LTC3203/LTC3203-1 LTC3203B/LTC3203B-1

## TYPICAL APPLICATION

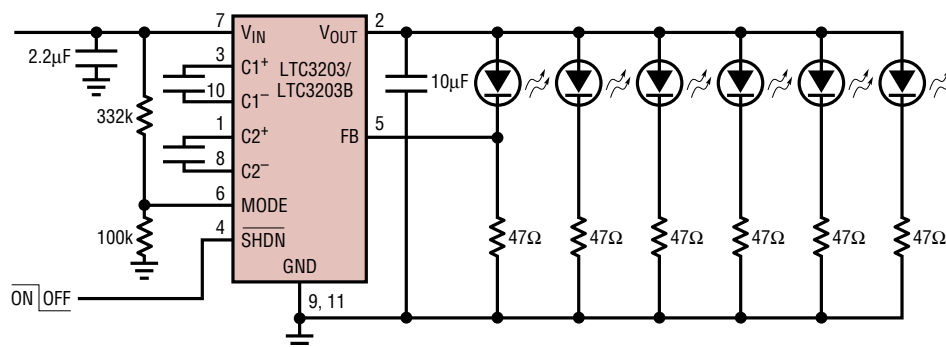

## RELATED PARTS

PART NUMBER	DESCRIPTION	COMMENTS
LT <sup>®</sup> 1618	Constant Current, Constant Voltage, 1.4MHz High Efficiency Boost Regulator	Up to 16 White LEDs, $V_{IN}$ : 1.6V to 18V, $V_{OUT(MAX)}$ = 34V, $I_Q$ = 1.8mA, $I_{SD} \leq 1\mu A$ , 10-Lead MS Package
LTC1911-1.5	250mA ( $I_{OUT}$ ), 1.5MHz High Efficiency Step-Down Charge Pump	75% Efficiency, $V_{IN}$ : 2.7V to 5.5V, $V_{OUT(MIN)}$ = 1.5V/1.8V, $I_Q$ = 180µA, $I_{SD} \leq 10\mu A$ , MS8 Package
LT1932	Constant Current, 1.2MHz High Efficiency White LED Boost Regulator	Up to 8 White LEDs, $V_{IN}$ : 1V to 10V, $V_{OUT(MAX)}$ = 34V, $I_Q$ = 1.2mA, $I_{SD} \leq 1\mu A$ , ThinSOT <sup>™</sup> Package
LT1937	Constant Current, 1.2MHz High Efficiency White LED Boost Regulator	Up to 4 White LEDs, $V_{IN}$ : 2.5V to 10V, $V_{OUT(MAX)}$ = 34V, $I_Q$ = 1.9mA, $I_{SD} \leq 1\mu A$ , ThinSOT, SC70 Packages
LTC3200-5	Low Noise, 2MHz Regulated Charge Pump White LED Driver	Up to 6 White LEDs, $V_{IN}$ : 2.7V to 4.5V, $V_{OUT(MAX)}$ = 5V, $I_Q$ = 8mA, $I_{SD} \leq 1\mu A$ , ThinSOT Package
LTC3201	Low Noise, 1.7MHz Regulated Charge Pump White LED Driver	Up to 6 White LEDs, $V_{IN}$ : 2.7V to 4.5V, $V_{OUT(MAX)}$ = 5V, $I_Q$ = 6.5mA, $I_{SD} \leq 1\mu A$ , 10-Lead MS Package
LTC3202	Low Noise, 1.7MHz Regulated Charge Pump White LED Driver	Up to 8 White LEDs, $V_{IN}$ : 2.7V to 4.5V, $V_{OUT(MAX)}$ = 5V, $I_Q$ = 5mA, $I_{SD} \leq 1\mu A$ , 10-Lead MS Package
LTC3204-3.3/LTC3204B-3.3 LTC3204-5/LTC3204B-5	Low Noise Regulated Charge Pumps in $2 \times 2$ DFN ("B" Version Defeats Burst Mode Operation)	$V_{IN}$ : 1.8V to 4.5V (LTC3204/LTC3204B-3.3), 2.7V to 5.5V (LTC3204/LTC3204B-5), $I_{OUT}$ = 50mA (LTC3204/LTC3204B-3.3), 150mA (LTC3204/LTC3204B-5) 6-Lead $2 \times 2$ DFN Package
LTC3205	Multi-Display LED Controller	92% Efficiency, $V_{IN}$ : 2.8V to 4.5V, $I_Q$ = 50µA, $I_{SD} \leq 1\mu A$ , 4mm x 4mm QFN Package
LTC3206	Highly Integrated Multi-Display LED Controller	92% Efficiency, $V_{IN}$ : 2.7V to 4.5V, $I_Q$ = 180µA, $I_{SD} \leq 1\mu A$ , 4mm x 4mm QFN Package
LTC3251	500mA ( $I_{OUT}$ ), 1MHz to 1.6MHz Spread Spectrum Step-Down Charge Pump	85% Efficiency, $V_{IN}$ : 3.1V to 5.5V, $V_{OUT}$ : 0.9V to 1.6V, $I_Q$ = 9µA, $I_{SD} \leq 1\mu A$ , 10-Lead MS Package
LTC3405/LTC3405A	300mA ( $I_{OUT}$ ), 1.5MHz Synchronous Step-Down DC/DC Converter	95% Efficiency, $V_{IN}$ : 2.7V to 6V, $V_{OUT(MIN)}$ = 0.8V, $I_Q$ = 20µA, $I_{SD} \leq 1\mu A$ , ThinSOT Package
LTC3406/LTC3406B	600mA ( $I_{OUT}$ ), 1.5MHz Synchronous Step-Down DC/DC Converter	95% Efficiency, $V_{IN}$ : 2.5V to 5.5V, $V_{OUT(MIN)}$ = 0.6V, $I_Q$ = 20µA, $I_{SD} \leq 1\mu A$ , ThinSOT Package
LTC3440	600mA ( $I_{OUT}$ ), 2MHz Synchronous Buck-Boost DC/DC Converter	95% Efficiency, $V_{IN}$ : 2.5V to 5.5V, $V_{OUT(MIN)}$ = 2.5V, $I_Q$ = 25µA, $I_{SD} \leq 1\mu A$ , 10-Lead MS Package
LT3465/LT3465A	1.2MHz/2.7MHz with Internal Schottky	Up to 6 White LEDs, $V_{IN}$ : 12.7V to 16V, $V_{OUT(MAX)}$ = 34V, $I_Q$ = 1.9mA, $I_{SD} < 1\mu A$ , ThinSOT Package

ThinSOT is a trademark of Linear Technology Corporation.

## Looking for pricing, stock, or lifecycle information?

Click below to explore more details on WIN SOURCE:

 [View LTC3203EDD-1#PBF on WIN SOURCE](#)

 [Linear Technology](#) Information

## Optimize Your Supply Chain with WIN SOURCE Solutions

-  Global Sourcing Solution
-  Obsolete Management
-  Cost Control Management
-  Shortage Management
-  Alternative Solution
-  Excess Inventory Management