



**THE DATASHEET OF  
LTC3526BEDC-2#TRMPBF**



**NOT RECOMMENDED FOR NEW DESIGNS**  
 Contact Linear Technology for Potential Replacement

## FEATURES

- Delivers 3.3V at 100mA from a Single Alkaline/ NiMH Cell or 3.3V at 200mA from Two Cells
- $V_{IN}$  Start-Up Voltage: 850mV
- $V_{IN}$  Operating Range: 0.5V to 5V
- 1.6V to 5.25V  $V_{OUT}$  Range
- Up to 94% Efficiency
- Output Disconnect
- 2MHz Fixed Frequency Operation
- $V_{IN} > V_{OUT}$  Operation
- Integrated Soft-Start
- Current Mode Control with Internal Compensation
- Burst Mode<sup>®</sup> Operation with 9 $\mu$ A Quiescent Current (LTC3526-2)
- Low Noise PWM Operation (LTC3526B-2)
- Internal Synchronous Rectifier
- Logic Controlled Shutdown ( $I_Q < 1\mu$ A)
- Anti-Ringing Control
- Low Profile (2mm × 2mm × 0.75mm) DFN-6 Package

## APPLICATIONS

- Medical Instruments
- Flash-Based MP3 Players
- Noise Canceling Headphones
- Wireless Mice
- Bluetooth Headsets

## DESCRIPTION

The LTC<sup>®</sup>3526-2/LTC3526B-2 are synchronous, fixed frequency step-up DC/DC converters with output disconnect. Synchronous rectification enables high efficiency in the low profile 2mm × 2mm DFN package. Battery life in single AA/AAA powered products is extended further with an 850mV start-up voltage and operation down to 500mV once started.

A switching frequency of 2MHz minimizes solution footprint by allowing the use of tiny, low profile inductors and ceramic capacitors. The current mode PWM design is internally compensated, reducing external parts count. The LTC3526-2 features Burst Mode operation at light load conditions, while the LTC3526B-2 features continuous switching. Anti-ringing circuitry eliminates EMI concerns by damping the inductor in discontinuous mode. Additional features include a low shutdown current of under 1 $\mu$ A and thermal shutdown.

The LTC3526-2/LTC3526B-2 are housed in a 6-pin 2mm × 2mm × 0.75mm DFN package.

For new designs, we recommend the LTC3526L-2/LTC3526LB-2.

LT, LT, LTC, LTM, Linear Technology, the Linear logo and Burst Mode are registered trademarks and ThinSOT is a trademark of Linear Technology Corporation. All other trademarks are the property of their respective owners. Patents pending.

## TYPICAL APPLICATION

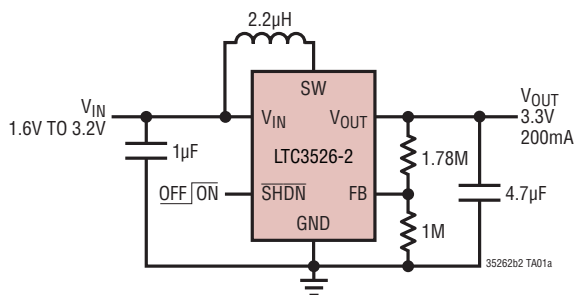

**LTC3526-2 Efficiency and Power Loss vs Load Current**

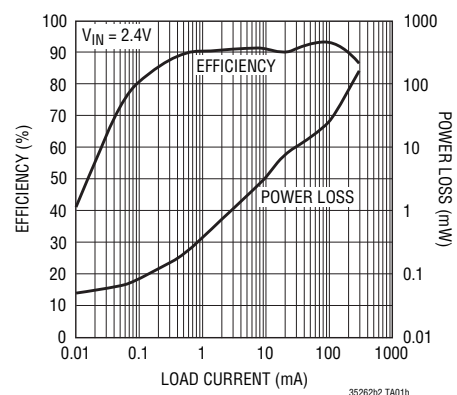

35262b2fc

# LTC3526-2/LTC3526B-2

## ABSOLUTE MAXIMUM RATINGS

(Note 1)

$V_{IN}$ Voltage	-0.3V to 6V
SW Voltage	
DC	-0.3V to 6V
Pulsed <100ns	-0.3V to 7V
SHDN, FB Voltage	-0.3V to 6V
$V_{OUT}$	-0.3V to 6V
Operating Temperature Range (Note 2)	-40°C to 85°C
Storage Temperature Range	-65°C to 150°C

## PIN CONFIGURATION

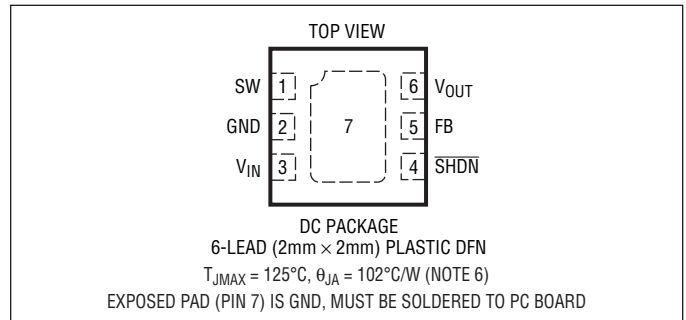

## ORDER INFORMATION

LEAD FREE FINISH	TAPE AND REEL	PART MARKING	PACKAGE DESCRIPTION	TEMPERATURE RANGE
LTC3526EDC-2#PBF	LTC3526EDC-2#TRPBF	LCNM	6-Lead (2mm × 2mm) Plastic DFN	-40°C to 85°C
LTC3526BEDC-2#PBF	LTC3526BEDC-2#TRPBF	LCNP	6-Lead (2mm × 2mm) Plastic DFN	-40°C to 85°C

Consult LTC Marketing for parts specified with wider operating temperature ranges.

Consult LTC Marketing for information on non-standard lead based finish parts.

For more information on lead free part marking, go to: <http://www.linear.com/leadfree/>

For more information on tape and reel specifications, go to: <http://www.linear.com/tapeandree/>

## ELECTRICAL CHARACTERISTICS

The ● denotes the specifications which apply over the specified operating temperature range of -40°C to 85°C, otherwise specifications are at  $T_A = 25^\circ\text{C}$ .  $V_{IN} = 1.2\text{V}$ ,  $V_{OUT} = 3.3\text{V}$  unless otherwise noted.

PARAMETER	CONDITIONS	MIN	TYP	MAX	UNITS
Minimum Start-Up Input Voltage	$I_{LOAD} = 1\text{mA}$		0.85	1	V
Output Voltage Adjust Range	0°C to 85°C	● 1.7 1.6		5.25 5.25	V V
Feedback Pin Voltage		● 1.165	1.195	1.225	V
Feedback Pin Input Current	$V_{FB} = 1.30\text{V}$		1	50	nA
Quiescent Current—Shutdown	$V_{SHDN} = 0\text{V}$ , Not Including Switch Leakage, $V_{OUT} = 0\text{V}$		0.01	1	μA
Quiescent Current—Active	Measured on $V_{OUT}$ , Nonswitching		250	500	μA
Quiescent Current—Burst	Measured on $V_{OUT}$ , $FB > 1.230\text{V}$ (LTC3526-2 Only)		9	18	μA
N-Channel MOSFET Switch Leakage Current	$V_{SW} = 5\text{V}$		0.1	5	μA
P-Channel MOSFET Switch Leakage Current	$V_{SW} = 5\text{V}$ , $V_{OUT} = 0\text{V}$		0.1	10	μA
N-Channel MOSFET Switch On Resistance	$V_{OUT} = 3.3\text{V}$		0.4		Ω
P-Channel MOSFET Switch On Resistance	$V_{OUT} = 3.3\text{V}$		0.6		Ω
N-Channel MOSFET Current Limit		● 500	700		mA
Current Limit Delay to Output	(Note 3)		60		ns
Maximum Duty Cycle	$V_{FB} = 1.15\text{V}$ , $V_{OUT} = 5\text{V}$	● 85	90		%
Minimum Duty Cycle	$V_{FB} = 1.3\text{V}$	●		0	%
Switching Frequency		● 1.8	2	2.4	MHz
SHDN Pin Input High Voltage		0.9			V
SHDN Pin Input Low Voltage				0.3	V
SHDN Pin Input Current	$V_{SHDN} = 1.2\text{V}$ $V_{SHDN} = 3.3\text{V}$		0.3 1	1 2	μA μA

35262b2fc

## ELECTRICAL CHARACTERISTICS

**Note 1:** Stresses beyond those listed under Absolute Maximum Ratings may cause permanent damage to the device. Exposure to any Absolute Maximum Rating condition for extended periods may affect device reliability and lifetime.

**Note 2:** The LTC3526E-2 is guaranteed to meet performance specifications from 0°C to 85°C. Specifications over -40°C to 85°C operating temperature range are assured by design, characterization and correlation with statistical process controls.

**Note 3:** Specification is guaranteed by design and not 100% tested in production.

**Note 4:** Current measurements are made when the output is not switching.

**Note 5:** This IC includes overtemperature protection that is intended to protect the device during momentary overload conditions. Junction temperature will exceed 125°C when overtemperature protection is active. Continuous operation above the specified maximum operating junction temperature may result in device degradation or failure.

**Note 6:** Failure to solder the exposed backside of the package to the PC board ground plane will result in a thermal resistance much higher than 102°C/W.

## TYPICAL PERFORMANCE CHARACTERISTICS

Efficiency vs Load Current and  $V_{IN}$  for  $V_{OUT} = 1.8V$  (LTC3526-2)

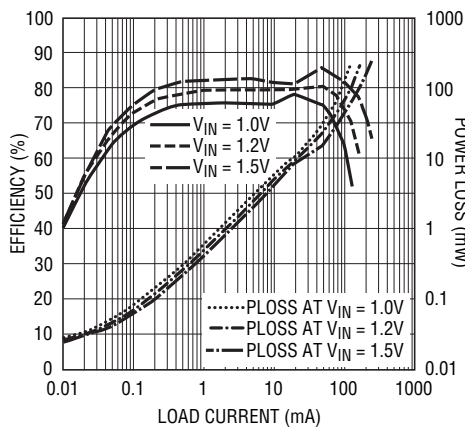

35262b2 G01

Efficiency vs Load Current and  $V_{IN}$  for  $V_{OUT} = 3.3V$  (LTC3526-2)

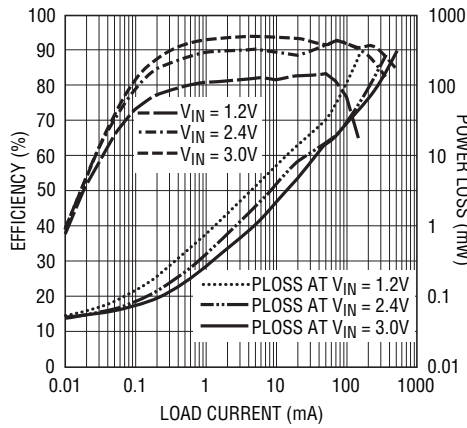

35262b2 G02

No-Load Input Current vs  $V_{IN}$

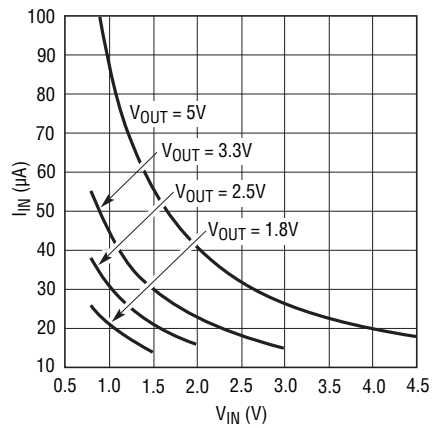

35262b2 G04

Efficiency vs Load Current and  $V_{IN}$  for  $V_{OUT} = 5V$  (LTC3526-2)

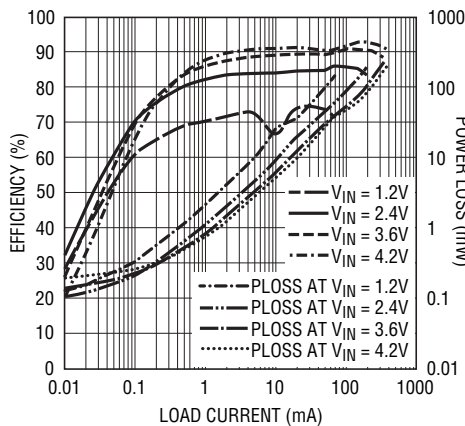

35262b2 G03

Maximum Output Current vs  $V_{IN}$

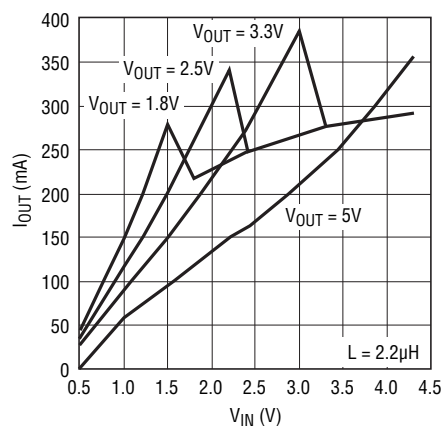

35262b2 G05

Minimum Load Resistance During Start-Up vs  $V_{IN}$

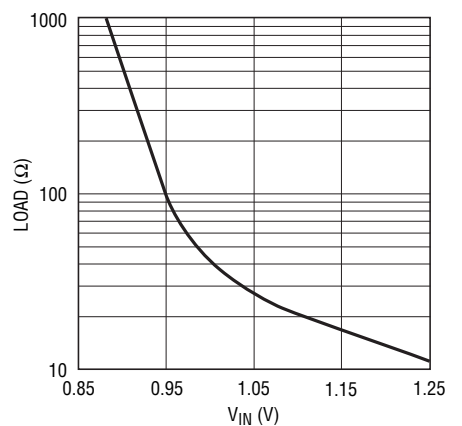

35262b2 G06

## TYPICAL PERFORMANCE CHARACTERISTICS

**Start-Up Delay Time vs  $V_{IN}$**

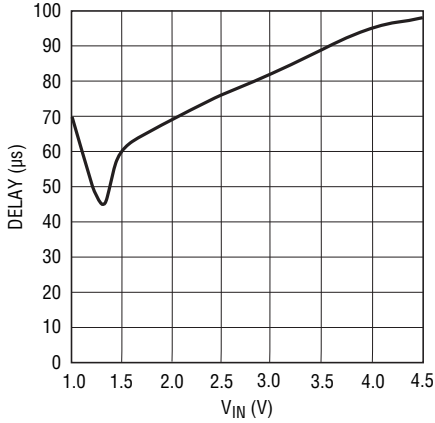

35262b2 G07

**Burst Mode Threshold Current vs  $V_{IN}$**

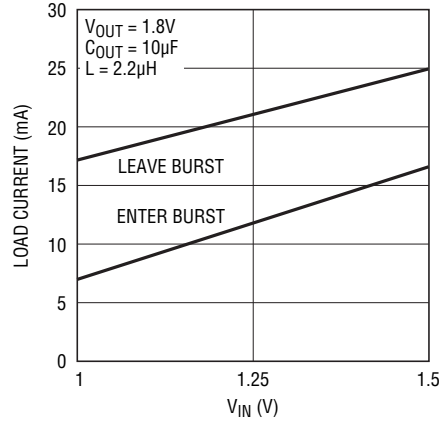

35262b2 G08a

**Burst Mode Threshold Current vs  $V_{IN}$**

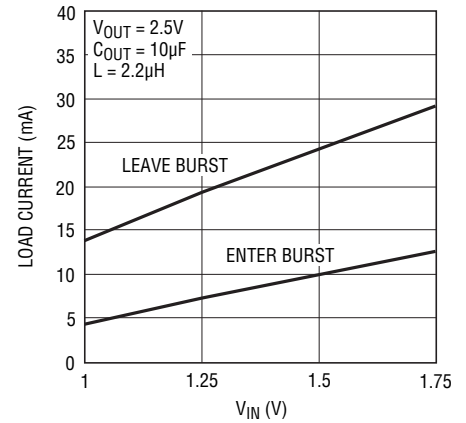

35262b2 G08b

**Burst Mode Threshold Current vs  $V_{IN}$**

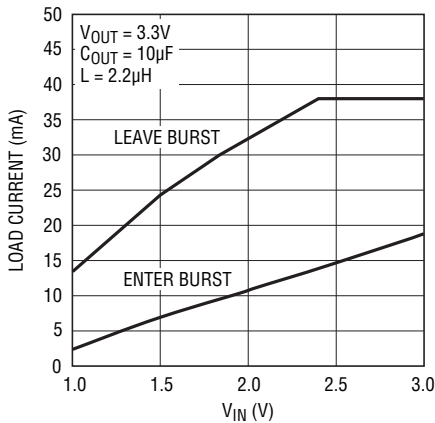

35262b2 G08c

**Burst Mode Threshold Current vs  $V_{IN}$**

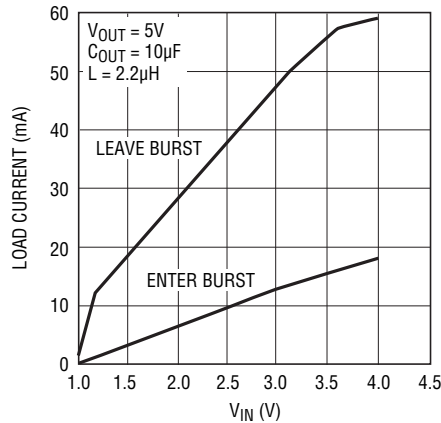

35262b2 G08d

**Oscillator Frequency Change vs  $V_{OUT}$**

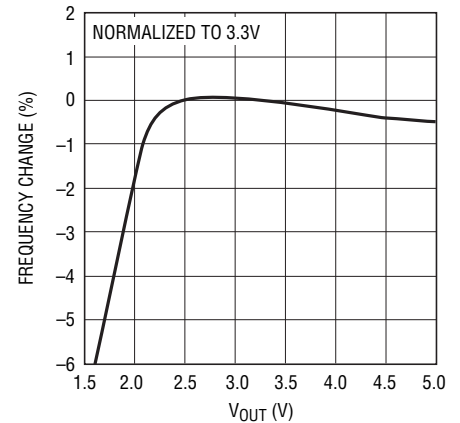

35262b2 G09

**$R_{DS(ON)}$  vs  $V_{OUT}$**

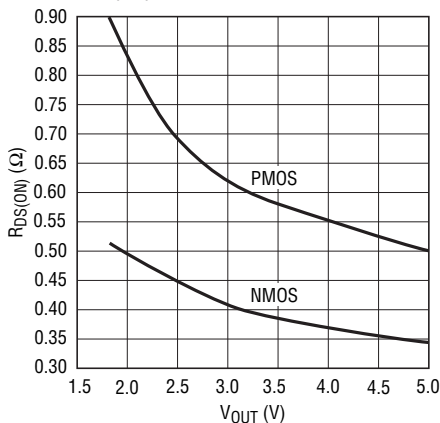

35262b2 G10

**Oscillator Frequency Change vs Temperature**

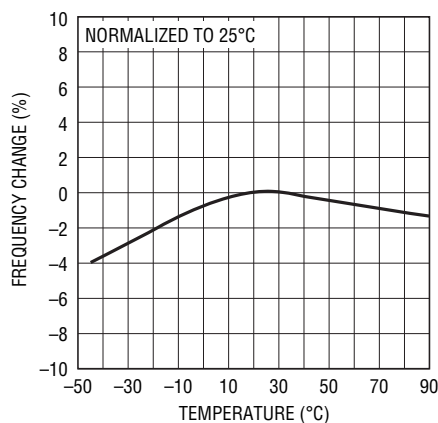

35262b2 G11

**$R_{DS(ON)}$  Change vs Temperature**

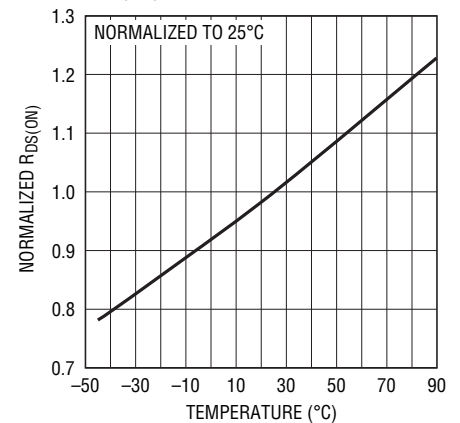

35262b2 G12

# TYPICAL PERFORMANCE CHARACTERISTICS

**V<sub>FB</sub> vs Temperature**

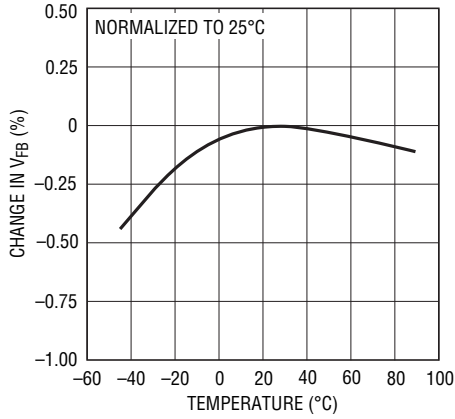

35262b2 G13

**Start-Up Voltage vs Temperature**

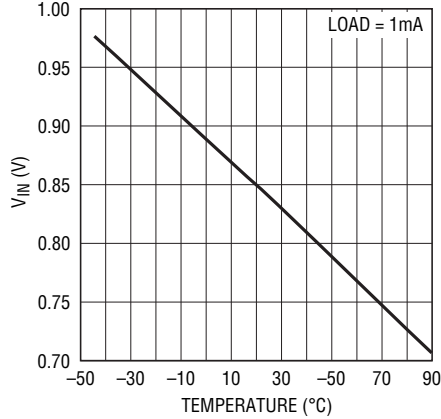

35262b2 G14

**Burst Mode Quiescent Current vs V<sub>OUT</sub>**

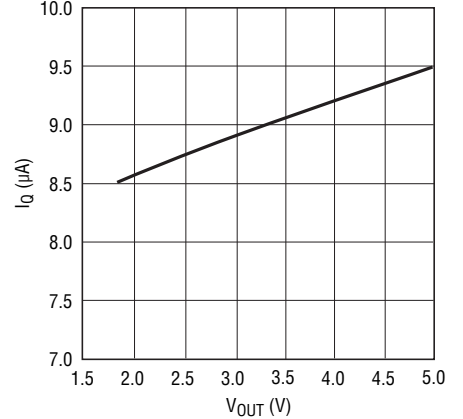

35262b2 G15

**Fixed Frequency Switching Waveform and V<sub>OUT</sub> Ripple**

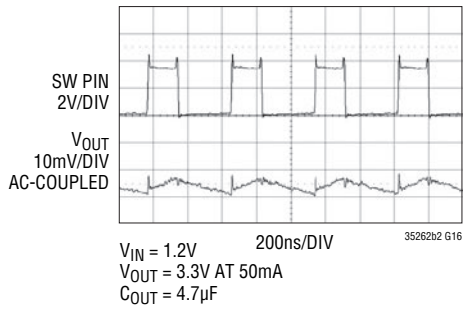

35262b2 G16

**Burst Mode Waveforms**

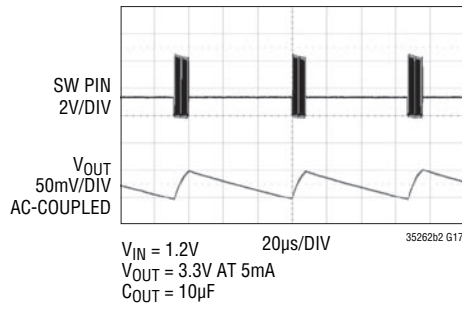

35262b2 G17

**V<sub>OUT</sub> and I<sub>IN</sub> During Soft-Start**

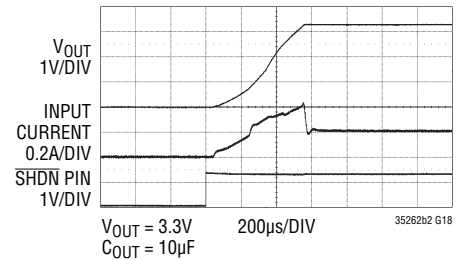

35262b2 G18

**Load Step Response (from Burst Mode Operation)**

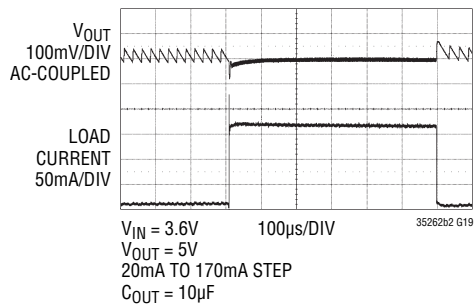

35262b2 G19

**Load Step Response (Fixed Frequency)**

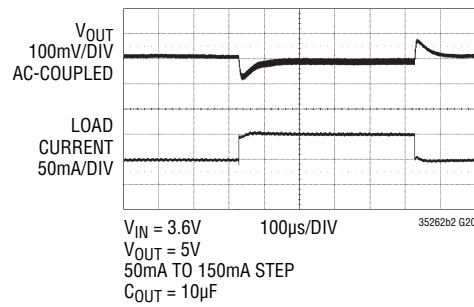

35262b2 G20

## TYPICAL PERFORMANCE CHARACTERISTICS

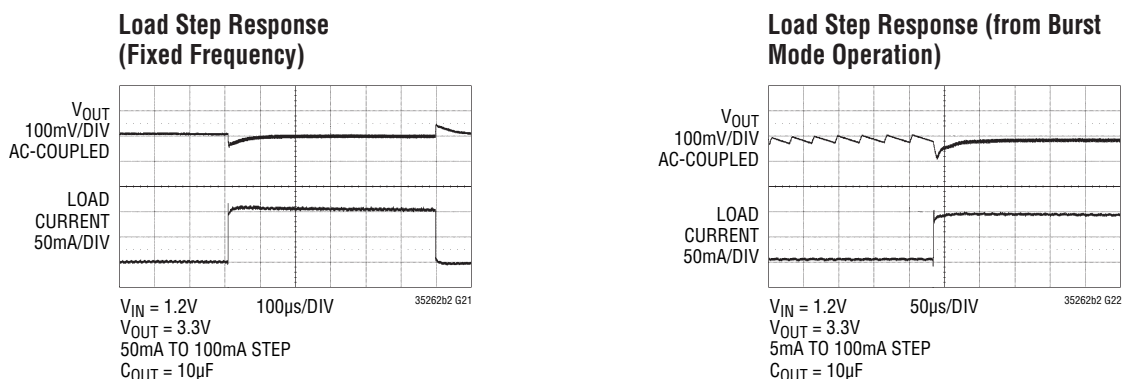

## PIN FUNCTIONS

**SW (Pin 1):** Switch Pin. Connect inductor between SW and  $V_{IN}$ . Keep PCB trace lengths as short and wide as possible to reduce EMI. If the inductor current falls to zero or  $\overline{SHDN}$  is low, an internal anti-ringing switch is connected from SW to  $V_{IN}$  to minimize EMI.

**GND (Pin 2):** Signal and Power Ground. Provide a short direct PCB path between GND and the (-) side of the input and output capacitors.

**$V_{IN}$  (Pin 3):** Input Supply Pin. Connect a minimum of  $1\mu F$  ceramic decoupling capacitor from this pin to ground using short direct PCB traces.

**SHDN (Pin 4):** Logic Controlled Shutdown Input. There is an internal  $4M\Omega$  pull-down on this pin.

- $\overline{SHDN}$  = High: Normal operation
- $\overline{SHDN}$  = Low: Shutdown, quiescent current  $< 1\mu A$

**FB (Pin 5):** Feedback Input to the  $g_m$  Error Amplifier.

Connect resistor divider tap to this pin. The top of the divider connects to the output capacitor, the bottom of the divider connects to GND. Referring to the Block Diagram, the output voltage can be adjusted from 1.6V to 5.25V by:

$$V_{OUT} = 1.195V \cdot \left( 1 + \frac{R2}{R1} \right)$$

**$V_{OUT}$  (Pin 6):** Output voltage sense and drain of the internal synchronous rectifier. PCB trace from  $V_{OUT}$  to the output filter capacitor ( $4.7\mu F$  minimum) should be as short and wide as possible.

**GND (Exposed Pad Pin 7):** The Exposed Pad must be soldered to the PCB ground plane. It serves as an additional ground connection and as a means of conducting heat away from the package.

## BLOCK DIAGRAM

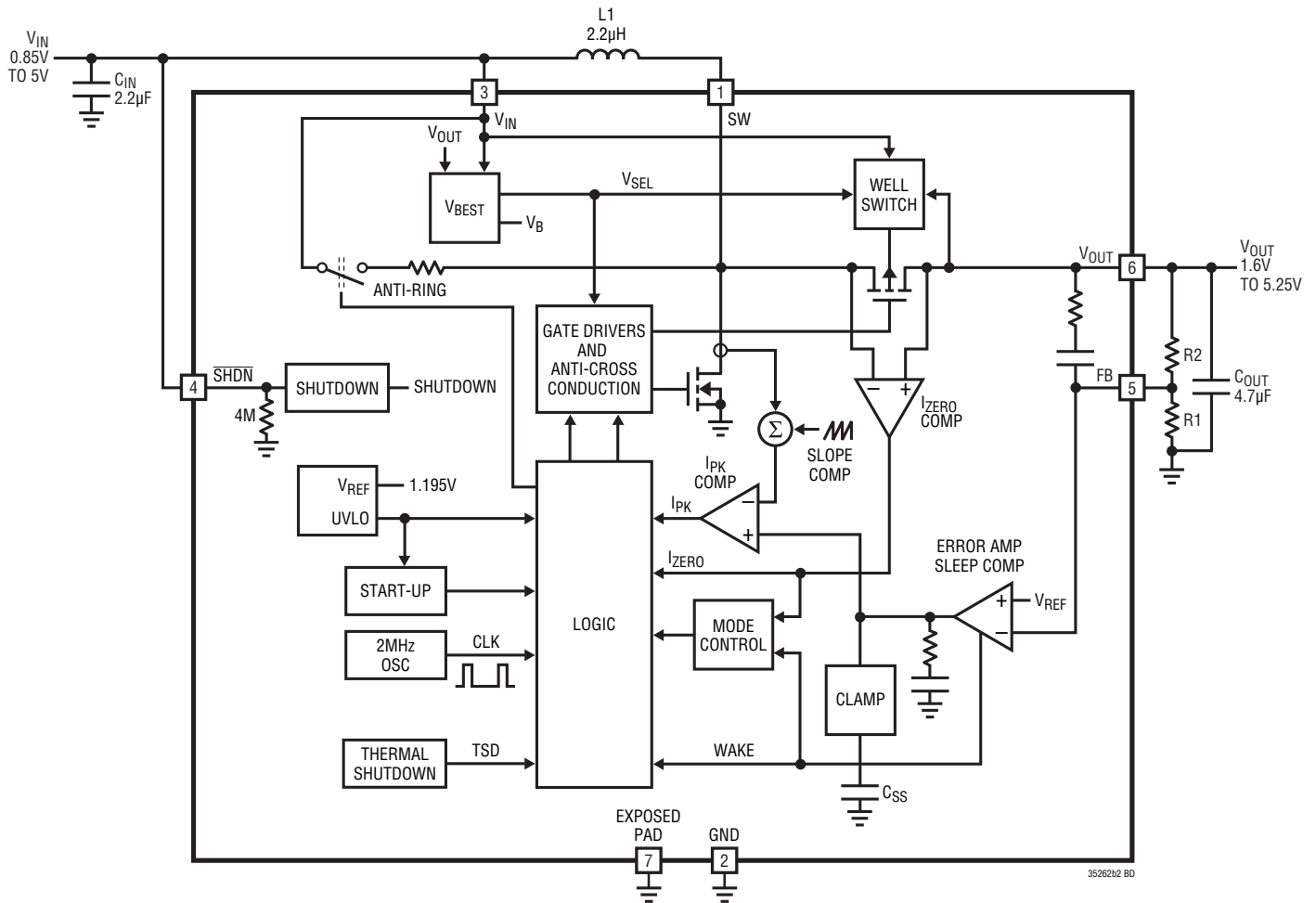

## OPERATION (Refer to Block Diagram)

The LTC3526-2/LTC3526B-2 are 2MHz synchronous boost converters housed in a 6-lead 2mm  $\times$  2mm DFN package. With the ability to start up and operate from inputs less than 1V, these devices feature fixed frequency, current mode PWM control for exceptional line and load regulation. The current mode architecture with adaptive slope compensation provides excellent transient load response, requiring minimal output filtering. Internal soft-start and internal loop compensation simplifies the design process while minimizing the number of external components.

With its low  $R_{DS(ON)}$  and low gate charge internal N-channel MOSFET switch and P-channel MOSFET synchronous rectifier, the LTC3526-2 achieves high efficiency over a wide

range of load currents. Automatic Burst Mode operation maintains high efficiency at very light loads, reducing the quiescent current to just 9  $\mu$ A. Operation can be best understood by referring to the Block Diagram.

## LOW VOLTAGE START-UP

The LTC3526-2/LTC3526B-2 include an independent start-up oscillator designed to start up at an input voltage of 0.85V (typical). Soft-start and inrush current limiting are provided during start-up, as well as normal mode.

When either  $V_{IN}$  or  $V_{OUT}$  exceeds 1.4V typical, the IC enters normal operating mode. When the output voltage

# LTC3526-2/LTC3526B-2

## OPERATION (Refer to Block Diagram)

exceeds the input by 0.24V, the IC powers itself from  $V_{OUT}$  instead of  $V_{IN}$ . At this point the internal circuitry has no dependency on the  $V_{IN}$  input voltage, eliminating the requirement for a large input capacitor. The input voltage can drop as low as 0.5V. The limiting factor for the application becomes the availability of the power source to supply sufficient energy to the output at low voltages, and maximum duty cycle, which is clamped at 90% typical. Note that at low input voltages, small voltage drops due to series resistance become critical, and greatly limit the power delivery capability of the converter.

## LOW NOISE FIXED FREQUENCY OPERATION

### Soft-Start

The LTC3526-2/LTC3526B-2 contain internal circuitry to provide soft-start operation. The soft-start circuitry slowly ramps the peak inductor current from zero to its peak value of 700mA (typical) in approximately 0.5ms, allowing start-up into heavy loads. The soft-start circuitry is reset in the event of a shutdown command or a thermal shutdown.

### Oscillator

An internal oscillator sets the switching frequency to 2MHz.

### Shutdown

Shutdown is accomplished by pulling the  $\overline{SHDN}$  pin below 0.3V and enabled by pulling the  $\overline{SHDN}$  pin above 0.8V typical. Although  $\overline{SHDN}$  can be driven above  $V_{IN}$  or  $V_{OUT}$  (up to the absolute maximum rating) without damage, the LTC3526-2/LTC3526B-2 have a proprietary test mode that may be engaged if  $\overline{SHDN}$  is held in the range of 0.5V to 1V higher than the greater of  $V_{IN}$  or  $V_{OUT}$ . If the test mode is engaged, normal PWM switching action is interrupted, which can cause undesirable operation in some applications. Therefore, in applications where  $\overline{SHDN}$  may be driven above  $V_{IN}$ , a resistor divider or other means must be employed to keep the  $\overline{SHDN}$  voltage below  $(V_{IN} + 0.4V)$  to prevent the possibility of the test mode being engaged. Please refer to Figure 1 for two possible implementations.

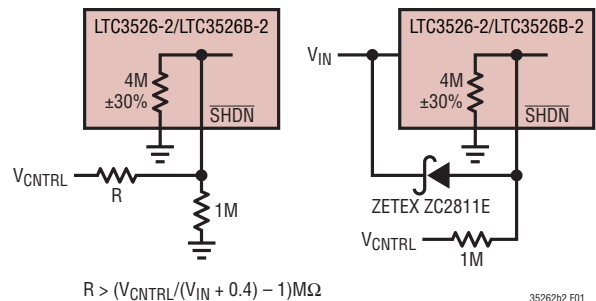

Figure 1. Recommended Shutdown Circuits when Driving  $\overline{SHDN}$  above  $V_{IN}$

### Error Amplifier

The positive input of the transconductance error amplifier is internally connected to the 1.195V reference and the negative input is connected to FB. Clamps limit the minimum and maximum error amp output voltage for improved large-signal transient response. Power converter control loop compensation is provided internally. An external resistive voltage divider from  $V_{OUT}$  to ground programs the output voltage via FB from 1.6V to 5.25V.

$$V_{OUT} = 1.195V \cdot \left(1 + \frac{R2}{R1}\right)$$

### Current Sensing

Lossless current sensing converts the peak current signal of the N-channel MOSFET switch into a voltage that is summed with the internal slope compensation. The summed signal is compared to the error amplifier output to provide a peak current control command for the PWM.

### Current Limit

The current limit comparator shuts off the N-channel MOSFET switch once its threshold is reached. The current limit comparator delay to output is typically 60ns. Peak switch current is limited to approximately 700mA, independent of input or output voltage, unless  $V_{OUT}$  falls below 0.7V, in which case the current limit is cut in half.

### Zero Current Comparator

The zero current comparator monitors the inductor current to the output and shuts off the synchronous rectifier

## OPERATION (Refer to Block Diagram)

when this current reduces to approximately 30mA. This prevents the inductor current from reversing in polarity, improving efficiency at light loads.

### Synchronous Rectifier

To control inrush current and to prevent the inductor current from running away when  $V_{OUT}$  is close to  $V_{IN}$ , the P-channel MOSFET synchronous rectifier is only enabled when  $V_{OUT} > (V_{IN} + 0.24V)$ .

### Anti-Ringing Control

The anti-ringing control connects a resistor across the inductor to prevent high frequency ringing on the SW pin during discontinuous current mode operation. Although the ringing of the resonant circuit formed by L and  $C_{SW}$  (capacitance on SW pin) is low energy, it can cause EMI radiation.

### Output Disconnect

The LTC3526-2/LTC3526B-2 are designed to allow true output disconnect by eliminating body diode conduction of the internal P-channel MOSFET rectifier. This allows for  $V_{OUT}$  to go to zero volts during shutdown, drawing no current from the input source. It also allows for inrush current limiting at turn-on, minimizing surge currents seen by the input supply. Note that to obtain the advantages of output disconnect, there must not be an external Schottky diode connected between the SW pin and  $V_{OUT}$ . The output disconnect feature also allows  $V_{OUT}$  to be pulled high, without any reverse current into a battery connected to  $V_{IN}$ .

### Thermal Shutdown

If the die temperature exceeds 160°C, the LTC3526-2/LTC3526B-2 will go into thermal shutdown. All switches will be off and the soft-start capacitor will be discharged. The device will be enabled again when the die temperature drops by about 15°C.

### Burst Mode OPERATION

The LTC3526-2 will automatically enter Burst Mode operation at light load and return to fixed frequency PWM mode when the load increases. Refer to the Typical Performance Characteristics to see the output load Burst Mode threshold current vs  $V_{IN}$ . The load current at which Burst Mode operation is entered can be changed by adjusting the inductor value. Raising the inductor value will lower the load current at which Burst Mode operation is entered.

In Burst Mode operation, the LTC3526-2 still switches at a fixed frequency of 2MHz, using the same error amplifier and loop compensation for peak current mode control. This control method eliminates any output transient when switching between modes. In Burst Mode operation, energy is delivered to the output until it reaches the nominal regulation value, then the LTC3526-2 transitions to sleep mode where the outputs are off and the LTC3526-2 consumes only 9 $\mu$ A of quiescent current from  $V_{OUT}$ . When the output voltage droops slightly, switching resumes. This maximizes efficiency at very light loads by minimizing switching and quiescent losses. Burst Mode output voltage ripple, which is typically 1% peak-to-peak, can be reduced by using more output capacitance (10 $\mu$ F or greater), or with a small capacitor (10pF to 50pF) connected between  $V_{OUT}$  and FB.

As the load current increases, the LTC3526-2 will automatically leave Burst Mode operation. Note that larger output capacitor values may cause this transition to occur at lighter loads. Once the LTC3526-2 has left Burst Mode operation and returned to normal operation, it will remain there until the output load is reduced below the burst threshold.

Burst Mode operation is inhibited during start-up and soft-start and until  $V_{OUT}$  is at least 0.24V greater than  $V_{IN}$ .

The LTC3526B-2 features continuous PWM operation at 2MHz. At very light loads, the LTC3526B-2 will exhibit pulse-skip operation.

## APPLICATIONS INFORMATION

### $V_{IN} > V_{OUT}$ OPERATION

The LTC3526-2/LTC3526B-2 will maintain voltage regulation even when the input voltage is above the desired output voltage. Note that the efficiency is much lower in this mode, and the maximum output current capability will be less. Refer to the Typical Performance Characteristics.

### SHORT-CIRCUIT PROTECTION

The LTC3526-2/LTC3526B-2 output disconnect feature allows output short circuit while maintaining a maximum internally set current limit. To reduce power dissipation under short-circuit conditions, the peak switch current limit is reduced to 400mA (typical).

### SCHOTTKY DIODE

Although it is not required, adding a Schottky diode from SW to  $V_{OUT}$  will improve efficiency by about 2%. Note that this defeats the output disconnect and short-circuit protection features.

### PCB LAYOUT GUIDELINES

The high speed operation of the LTC3526-2/LTC3526B-2 demands careful attention to board layout. A careless layout will result in reduced performance. Figure 2 shows the recommended component placement. A large ground pin copper area will help to lower the die temperature. A multilayer board with a separate ground plane is ideal, but not absolutely necessary.

## COMPONENT SELECTION

### Inductor Selection

The LTC3526-2/LTC3526B-2 can utilize small surface mount chip inductors due to their fast 2MHz switching frequency. Inductor values between 1.5 $\mu$ H and 3.3 $\mu$ H are suitable for most applications. Larger values of inductance will allow slightly greater output current capability (and lower the Burst Mode threshold) by reducing the inductor ripple current. Increasing the inductance above 10 $\mu$ H will increase size while providing little improvement in output current capability.

The minimum inductance value is given by:

$$L > \frac{V_{IN(MIN)} \cdot (V_{OUT(MAX)} - V_{IN(MIN)})}{2 \cdot RIPPLE \cdot V_{OUT(MAX)}}$$

where:

Ripple = Allowable inductor current ripple (amps peak-peak)

$V_{IN(MIN)}$  = Minimum input voltage

$V_{OUT(MAX)}$  = Maximum output voltage

The inductor current ripple is typically set for 20% to 40% of the maximum inductor current. High frequency ferrite core inductor materials reduce frequency dependent power losses compared to cheaper powdered iron types, improving efficiency. The inductor should have low ESR (series resistance of the windings) to reduce the  $I^2R$  power losses, and must be able to support the peak

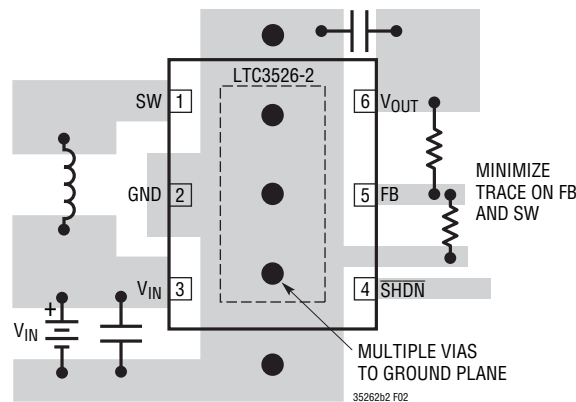

Figure 2. Recommended Component Placement for Single Layer Board

## APPLICATIONS INFORMATION

inductor current without saturating. Molded chokes and some chip inductors usually do not have enough core area to support the peak inductor currents of 700mA seen on the LTC3526-2/LTC3526B-2. To minimize radiated noise, use a shielded inductor. See Table 1 for suggested components and suppliers.

**Table 1. Recommended Inductors**

VENDOR	PART/STYLE
Coilcraft (847) 639-6400 www.coilcraft.com	LPO4815 LPS4012, LPS4018 MSS5131 MSS4020 MOS6020 ME3220 DS1605, DO1608
Coiltronics www.cooperet.com	SD10, SD12, SD14, SD18, SD20, SD52, SD3114, SD3118
FDK (408) 432-8331 www.fdk.com	MIP3226D4R7M, MIP3226D3R3M MIPF2520D4R7 MIPWT3226D3R0
Murata (714) 852-2001 www.murata.com	LQH43C LQH32C (-53 series) 301015
Sumida (847) 956-0666 www.sumida.com	CDRH5D18 CDRH2D14 CDRH3D16 CDRH3D11 CR43 CMD4D06-4R7MC CMD4D06-3R3MC
Taiyo-Yuden www.t-yuden.com	NP03SB NR3015T NR3012T
TDK (847) 803-6100 www.component.tdk.com	VLP VLF, VLFCF
Toko (408) 432-8282 www.tokoam.com	D412C D518LC D52LC D62LCB
Würth (201) 785-8800 www.we-online.com	WE-TPC type S, M

### Output and Input Capacitor Selection

Low ESR (equivalent series resistance) capacitors should be used to minimize the output voltage ripple. Multilayer ceramic capacitors are an excellent choice as they have extremely low ESR and are available in small footprints. A 4.7 $\mu$ F to 10 $\mu$ F output capacitor is sufficient for most applications. Larger values up to 22 $\mu$ F may be used to obtain extremely low output voltage ripple and improve transient response. X5R and X7R dielectric materials are preferred for their ability to maintain capacitance over wide voltage and temperature ranges. Y5V types should not be used.

The internal loop compensation of the LTC3526-2 is designed to be stable with output capacitor values of 4.7 $\mu$ F or greater (without the need for any external series resistor). Although ceramic capacitors are recommended, low ESR tantalum capacitors may be used as well.

A small ceramic capacitor in parallel with a larger tantalum capacitor may be used in demanding applications that have large load transients. Another method of improving the transient response is to add a small feed-forward capacitor across the top resistor of the feedback divider (from  $V_{OUT}$  to FB). A typical value of 22pF will generally suffice.

Low ESR input capacitors reduce input switching noise and reduce the peak current drawn from the battery. It follows that ceramic capacitors are also a good choice for input decoupling and should be located as close as possible to the device. A 2.2 $\mu$ F input capacitor is sufficient for most applications, although larger values may be used without limitations. Table 2 shows a list of several ceramic capacitor manufacturers. Consult the manufacturers directly for detailed information on their selection of ceramic capacitors.

**Table 2. Capacitor Vendor Information**

SUPPLIER	PHONE	WEBSITE
AVX	(803) 448-9411	www.avxcorp.com
Murata	(714) 852-2001	www.murata.com
Taiyo-Yuden	(408) 573-4150	www.t-yuden.com
TDK	(847) 803-6100	www.component.tdk.com
Samsung	(408) 544-5200	www.sem.samsung.com

# LTC3526-2/LTC3526B-2

## TYPICAL APPLICATIONS

### 1-Cell to 1.8V Converter with <1mm Maximum Height for Low-Noise Applications

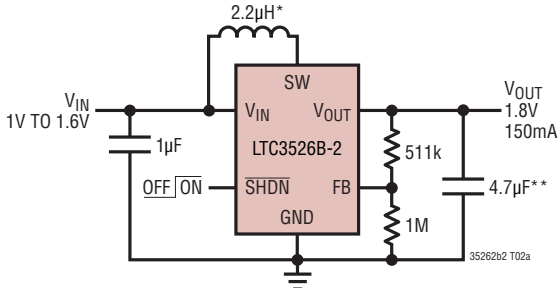

\*FDK MIPF2520D2R2  
\*\*MURATA GRM219R60J475KE19D

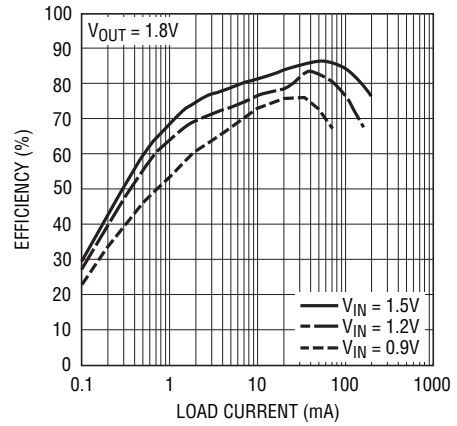

35262b2 TA02b

### 1-Cell to 3.3V

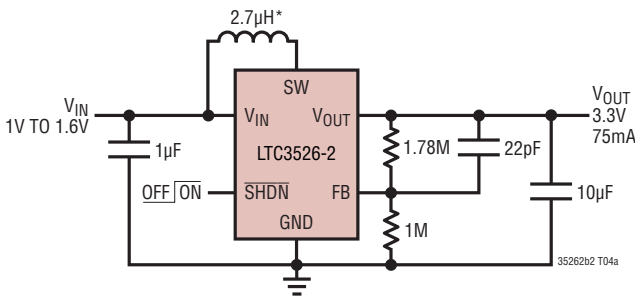

\*TAIYO-YUDEN NP03SB2R7M

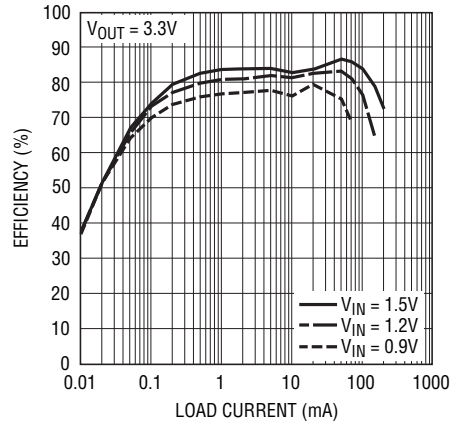

35262b2 TA04b

### 2-Cell to 3.3V

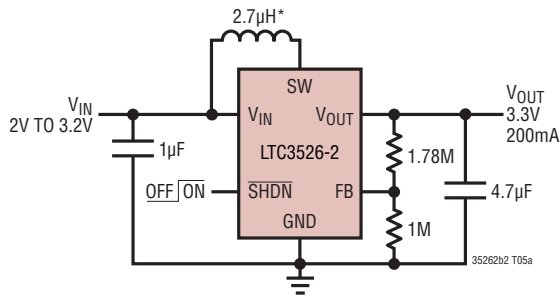

\*TAIYO-YUDEN NP03SB2R7M

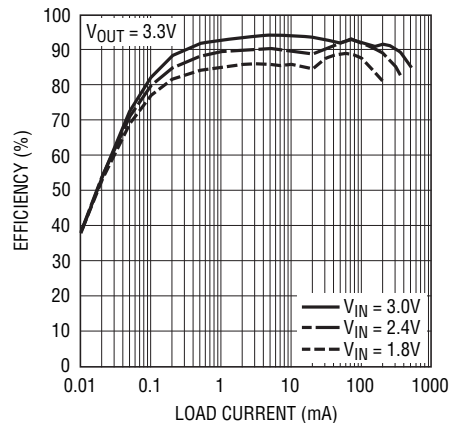

35262b2 TA05b

35262b2fc

TYPICAL APPLICATIONS

2-Cell to 5V

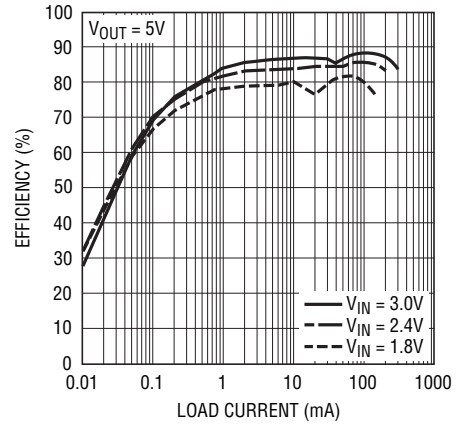
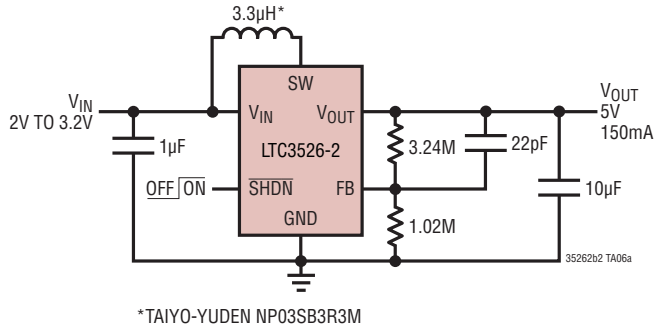

Li-Ion to 5V

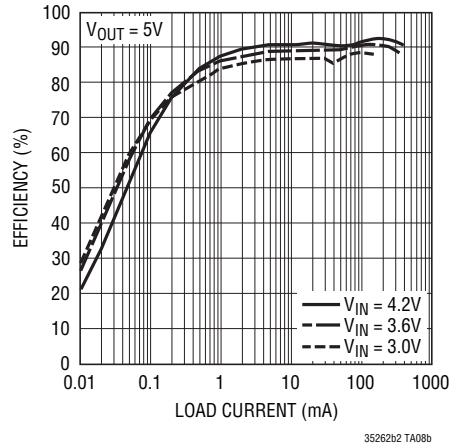
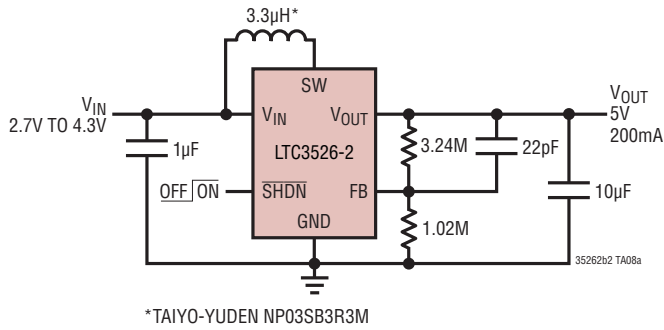

## PACKAGE DESCRIPTION

**DC Package**  
**6-Lead Plastic DFN (2mm × 2mm)**  
 (Reference LTC DWG # 05-08-1703 Rev B)

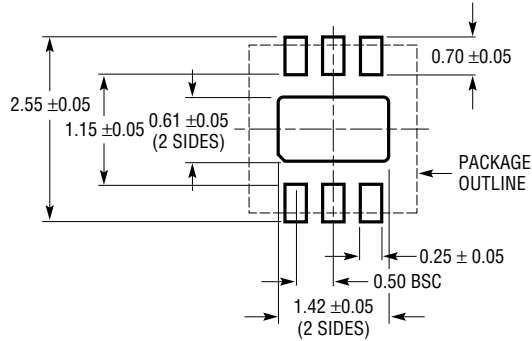

RECOMMENDED SOLDER PAD PITCH AND DIMENSIONS

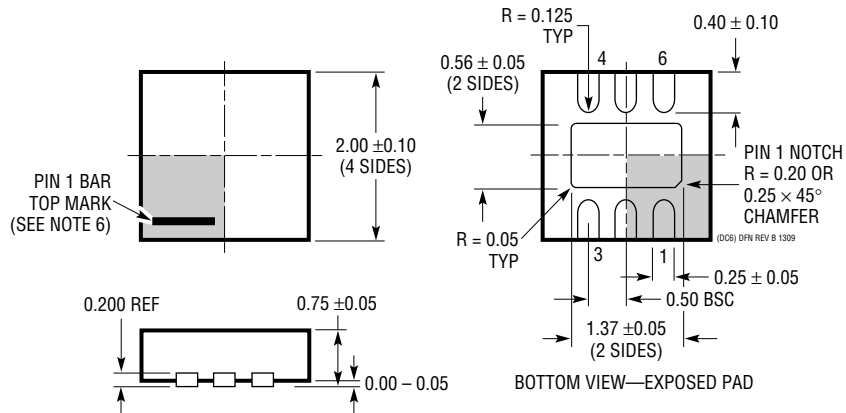

**NOTE:**

1. DRAWING TO BE MADE A JEDEC PACKAGE OUTLINE M0-229 VARIATION OF (WCDD-2)
2. DRAWING NOT TO SCALE
3. ALL DIMENSIONS ARE IN MILLIMETERS
4. DIMENSIONS OF EXPOSED PAD ON BOTTOM OF PACKAGE DO NOT INCLUDE MOLD FLASH. MOLD FLASH, IF PRESENT, SHALL NOT EXCEED 0.15mm ON ANY SIDE
5. EXPOSED PAD SHALL BE SOLDER PLATED
6. SHADED AREA IS ONLY A REFERENCE FOR PIN 1 LOCATION ON THE TOP AND BOTTOM OF PACKAGE

**REVISION HISTORY** (Revision history begins at Rev C)

REV	DATE	DESCRIPTION	PAGE NUMBER
C	9/10	Updated $\theta_{JA}$ on Pin Configuration	2
		Updated Note 6	3
		Updated Shutdown section	8
		Updated Related Parts	16

# LTC3526-2/LTC3526B-2

## TYPICAL APPLICATION

### 3.3V Converter with Output OR'd with 5V USB Input

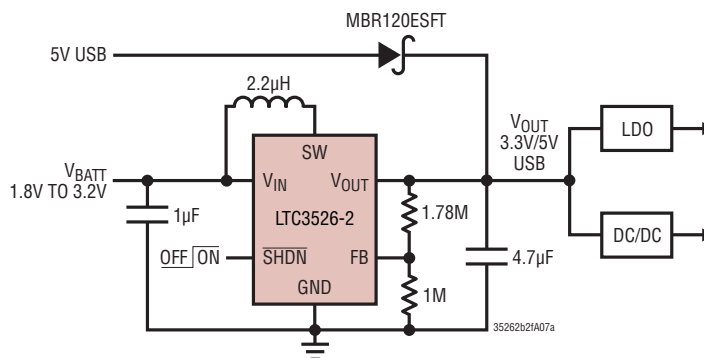



## RELATED PARTS

PART NUMBER	DESCRIPTION	COMMENTS
LTC3526/LTC3526B LTC3526L/LTC3526LB LTC3526L-2/LTC3526LB-2	500mA, 1MHz/2.2MHz, Synchronous Step-Up DC/DC Converters with Output Disconnect	94% Efficiency $V_{IN}$ : 0.85V to 5V, $V_{OUT(MAX)} = 5.25V$ , $I_Q = 9\mu A$ , $I_{SD} < 1\mu A$ , 2mm × 2mm DFN-6 Package
LTC3525L-3	400mA Micropower Synchronous Step-Up DC/DC Converter with Output Disconnect	93% Efficiency $V_{IN}$ : 0.88V to 4.5V, $V_{OUT} = 3V$ , $I_Q = 7\mu A$ , $I_{SD} < 1\mu A$ , SC-70 Package
LTC3525-3 LTC3525-3.3 LTC3525-5	400mA Micropower Synchronous Step-Up DC/DC Converter with Output Disconnect	95% Efficiency $V_{IN}$ : 1V to 4.5V, $V_{OUT(MAX)} = 3.3V$ or 5V, $I_Q = 7\mu A$ , $I_{SD} < 1\mu A$ , SC-70 Package
LTC3427	500mA $I_{SW}$ , 1.2MHZ, Synchronous Step-Up DC/DC Converter with Output Disconnect	93% Efficiency $V_{IN}$ : 1.8V to 4.5V, $V_{OUT(MAX)} = 5V$ , 2mm × 2mm DFN Package
LTC3400/LTC3400B	600mA $I_{SW}$ , 1.2MHz, Synchronous Step-Up DC/DC Converters	92% Efficiency $V_{IN}$ : 1V to 5V, $V_{OUT(MAX)} = 5V$ , $I_Q = 19\mu A/300\mu A$ , $I_{SD} < 1\mu A$ , ThinSOT™ Package
LTC3527/LTC3527-1	Dual 600mA/400mA $I_{SW}$ , 1.2MHz/2.2MHz Synchronous Step-Up DC/DC Converters	94% Efficiency $V_{IN}$ : 0.7V to 5V, $V_{OUT(MAX)} = 5.25V$ , $I_Q = 12\mu A$ , $I_{SD} < 1\mu A$ , 3mm × 3mm QFN-16 Package

35262b2fc

## Looking for pricing, stock, or lifecycle information?

Click below to explore more details on WIN SOURCE:

-  [View LTC3526BEDC-2#TRMPBF on WIN SOURCE](#)
-  [Linear Technology](#) Information

## Optimize Your Supply Chain with WIN SOURCE Solutions

-  Global Sourcing Solution
-  Obsolete Management
-  Cost Control Management
-  Shortage Management
-  Alternative Solution
-  Excess Inventory Management