



# No $R_{SENSE}^{\text{TM}}$ , Low Input Voltage, Synchronous DC/DC Controller with Output Tracking

## FEATURES

- Programmable Output Voltage Tracking
- No Current Sense Resistor Required
- Constant Frequency Current Mode Operation for Excellent Line and Load Transient Response
- Wide  $V_{IN}$  Range: 2.75V to 9.8V
- Wide  $V_{OUT}$  Range: 0.6V to  $V_{IN}$
- $0.6V \pm 1.5\%$  Reference
- Low Dropout Operation: 100% Duty Cycle
- Selectable Burst Mode<sup>®</sup>/Pulse-Skipping/Forced Continuous Operation
- Auxiliary Winding Regulation
- Internal Soft-Start Circuitry
- Selectable Maximum Peak Current Sense Threshold
- Output Overvoltage Protection
- Micropower Shutdown:  $I_Q = 9\mu A$
- Tiny Thermally Enhanced Leadless (3mm × 3mm) DFN and 10-lead MSOP Packages

## APPLICATIONS

- 1- or 2-Cell Lithium-Ion Powered Devices
- Notebook and Palmtop Computers, PDAs
- Portable Instruments
- Distributed DC Power Systems

## DESCRIPTION

The LTC<sup>®</sup>3809-1 is a synchronous step-down switching regulator controller that drives external complementary power MOSFETs using few external components. The constant frequency current mode architecture with MOSFET  $V_{DS}$  sensing eliminates the need for a current sense resistor and improves efficiency.

Optional Burst Mode operation provides high efficiency operation at light loads. 100% duty cycle provides low dropout operation, extending operating time in battery-powered systems. Burst Mode is inhibited when the MODE pin is pulled low to reduce noise and RF interference.

The LTC3809-1 allows either coincident or ratiometric output voltage tracking. Switching frequency is fixed at 550kHz. Fault protection is provided by an overvoltage comparator and a short-circuit current limit comparator.

The LTC3809-1 is available in tiny footprint thermally enhanced DFN and 10-lead MSOP packages.

LT, LTC and LTM are registered trademarks of Linear Technology Corporation. Burst is a registered trademark of Linear Technology Corporation. No  $R_{SENSE}$  is a trademark of Linear Technology Corporation. All other trademarks are the property of their respective owners. Protected by U.S. Patents including 5481178, 5929620, 6580258, 6304066, 5847554, 6611131, 6498466. Other Patents pending.

## TYPICAL APPLICATION

High Efficiency, 550kHz Step-Down Converter

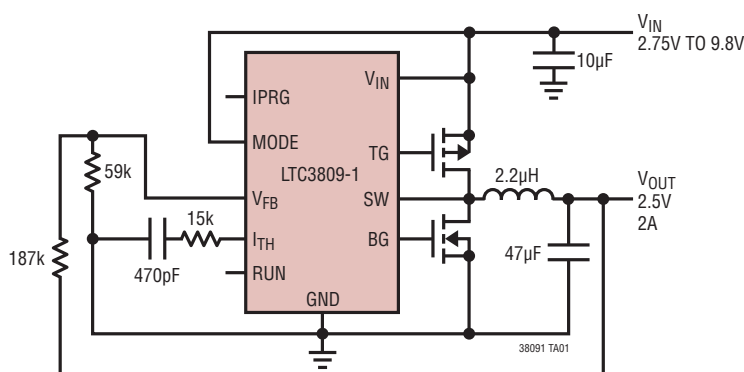

Efficiency and Power Loss vs Load Current

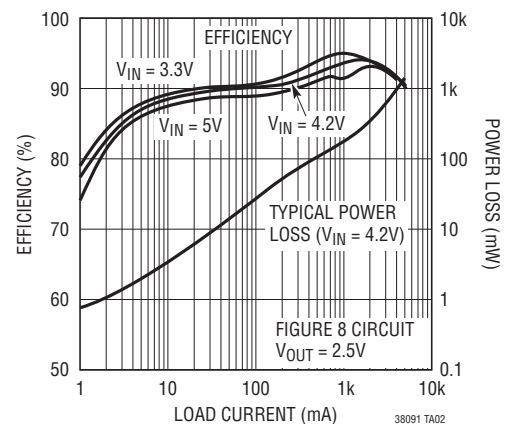

38091fc

# LTC3809-1

## ABSOLUTE MAXIMUM RATINGS (Note 1)

Input Supply Voltage ( $V_{IN}$ ) ..... -0.3V to 10V  
 RUN, TRACK/SS, MODE,  
 IPRG Voltages ..... -0.3V to ( $V_{IN} + 0.3V$ )  
 $V_{FB}$ ,  $I_{TH}$  Voltages ..... -0.3V to 2.4V  
 SW Voltage ..... -2V to  $V_{IN} + 1V$  (10V Max)  
 TG, BG Peak Output Current (<10 $\mu$ s) ..... 1A  
 Operating Temperature Range (Note 2).... -40°C to 85°C

Storage Ambient Temperature Range  
 DFN ..... -65°C to 125°C  
 MSOP ..... -65°C to 150°C  
 Junction Temperature (Note 3) ..... 125°C  
 Lead Temperature (Soldering, 10 sec)  
 MSOP Package ..... 300°C

## PIN CONFIGURATION

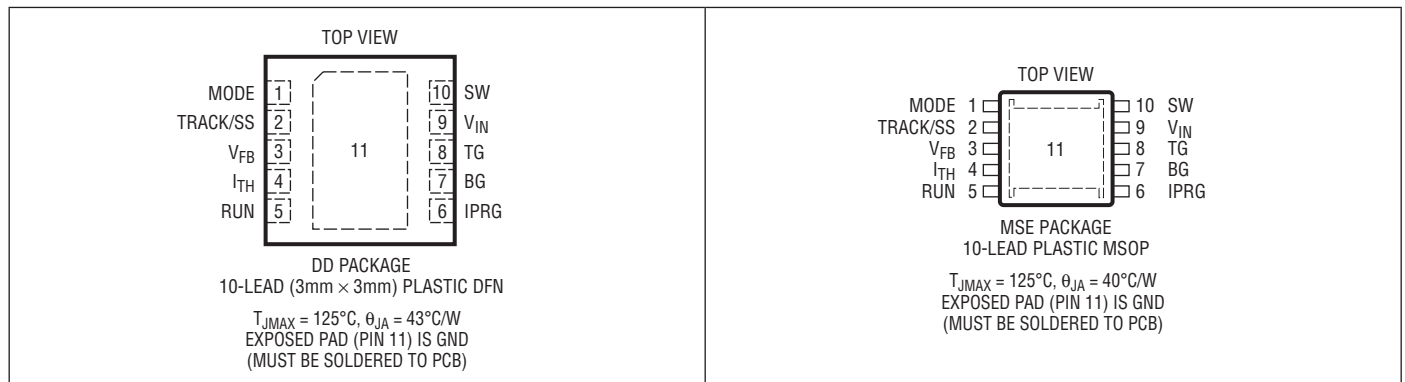

## ORDER INFORMATION

LEAD FREE FINISH	TAPE AND REEL	PART MARKING*	PACKAGE DESCRIPTION	TEMPERATURE RANGE
LTC3809EDD-1#PBF	LTC3809EDD-1#TRPBF	LBQZ	10-Lead (3mm × 3mm) Plastic DFN	-40°C to 85°C
LTC3809IDD-1#PBF	LTC3809IDD-1#TRPBF	LBQZ	10-Lead (3mm × 3mm) Plastic DFN	-40°C to 85°C
LTC3809EMSE-1#PBF	LTC3809EMSE-1#TRPBF	LTBQV	10-Lead Plastic MSOP	-40°C to 85°C
LTC3809IMSE-1#PBF	LTC3809IMSE-1#TRPBF	LTBQV	10-Lead Plastic MSOP	-40°C to 85°C
LEAD BASED FINISH	TAPE AND REEL	PART MARKING*	PACKAGE DESCRIPTION	TEMPERATURE RANGE
LTC3809EDD-1	LTC3809EDD-1#TR	LBQZ	10-Lead (3mm × 3mm) Plastic DFN	-40°C to 85°C
LTC3809IDD-1	LTC3809IDD-1#TR	LBQZ	10-Lead (3mm × 3mm) Plastic DFN	-40°C to 85°C
LTC3809EMSE-1	LTC3809EMSE-1#TR	LTBQV	10-Lead Plastic MSOP	-40°C to 85°C
LTC3809IMSE-1	LTC3809IMSE-1#TR	LTBQV	10-Lead Plastic MSOP	-40°C to 85°C

Consult LTC Marketing for parts specified with wider operating temperature ranges. \*The temperature grade is identified by a label on the shipping container.

For more information on lead free part marking, go to: <http://www.linear.com/leadfree/>

For more information on tape and reel specifications, go to: <http://www.linear.com/tapeandreeel/>

## ELECTRICAL CHARACTERISTICS

The ● indicates specifications which apply over the full operating temperature range, otherwise specifications are at  $T_A = 25^\circ\text{C}$ .  $V_{IN} = 4.2\text{V}$  unless otherwise noted.

PARAMETER	CONDITIONS		MIN	TYP	MAX	UNITS
<b>Main Control Loops</b>						
Input DC Supply Current Normal Operation Sleep Mode Shutdown UVLO	(Note 4)			350	500	$\mu\text{A}$
				105	150	$\mu\text{A}$
	RUN = 0V			9	20	$\mu\text{A}$
	$V_{IN} = \text{UVLO Threshold} - 200\text{mV}$			9	20	$\mu\text{A}$
Undervoltage Lockout Threshold (UVLO)	$V_{IN}$ Falling	●	1.95	2.25	2.55	V
	$V_{IN}$ Rising	●	2.15	2.45	2.75	V
Shutdown Threshold of RUN Pin			0.8	1.1	1.4	V
Start-Up Current Source	TRACK/SS = 0V		0.65	1	1.35	$\mu\text{A}$
Regulated Feedback Voltage	(Note 5)	●	0.591	0.6	0.609	V
Output Voltage Line Regulation	$2.75\text{V} < V_{IN} < 9.8\text{V}$ (Note 5)			0.01	0.04	%/V
Output Voltage Load Regulation	$I_{TH} = 0.9\text{V}$ (Note 5)			0.1	0.5	%
	$I_{TH} = 1.7\text{V}$			-0.1	-0.5	%
$V_{FB}$ Input Current	(Note 5)			9	50	nA
Overshoot Protection Threshold	Measured at $V_{FB}$		0.66	0.68	0.7	V
Overshoot Protection Hysteresis				20		mV
Auxiliary Feedback Threshold			0.325	0.4	0.475	V
Top Gate (TG) Drive Rise Time	$C_L = 3000\text{pF}$			40		ns
Top Gate (TG) Drive Fall Time	$C_L = 3000\text{pF}$			40		ns
Bottom Gate (BG) Drive Rise Time	$C_L = 3000\text{pF}$			50		ns
Bottom Gate (BG) Drive Fall Time	$C_L = 3000\text{pF}$			40		ns
Maximum Current Sense Voltage ( $\Delta V_{\text{SENSE(MAX)}}$ ) ( $V_{IN} - \text{SW}$ )	IPRG = Floating (Note 6)	●	110	125	140	mV
	IPRG = 0V (Note 6)	●	70	85	100	mV
	IPRG = $V_{IN}$ (Note 6)	●	185	204	223	mV
Soft-Start Time (Internal)	Time for $V_{FB}$ to Ramp from 0.05V to 0.55V		0.5	0.74	0.9	ms
Oscillator Frequency			480	550	600	kHz

**Note 1:** Stresses beyond those listed under Absolute Maximum Ratings may cause permanent damage to the device. Exposure to any Absolute Maximum Rating condition for extended periods may affect device reliability and lifetime.

**Note 2:** The LTC3809E-1 is guaranteed to meet specified performance from  $0^\circ\text{C}$  to  $85^\circ\text{C}$ . Specifications over the  $-40^\circ\text{C}$  to  $85^\circ\text{C}$  operating range are assured by design characterization, and correlation with statistical process controls. The LTC3809I-1 is guaranteed to meet specified performance over the full  $-40^\circ\text{C}$  to  $85^\circ\text{C}$  operating temperature range.

**Note 3:**  $T_J$  is calculated from the ambient temperature  $T_A$  and power dissipation  $P_D$  according to the following formula:

$$T_J = T_A + (P_D \cdot \theta_{JA} \text{ } ^\circ\text{C/W})$$

**Note 4:** Dynamic supply current is higher due to gate charge being delivered at the switching frequency.

**Note 5:** The LTC3809-1 is tested in a feedback loop that servos  $I_{TH}$  to a specified voltage and measures the resultant  $V_{FB}$  voltage.

**Note 6:** Peak current sense voltage is reduced dependent on duty cycle to a percentage of value as shown in Figure 1.

**TYPICAL PERFORMANCE CHARACTERISTICS**  $T_A = 25^\circ\text{C}$ , unless otherwise noted.

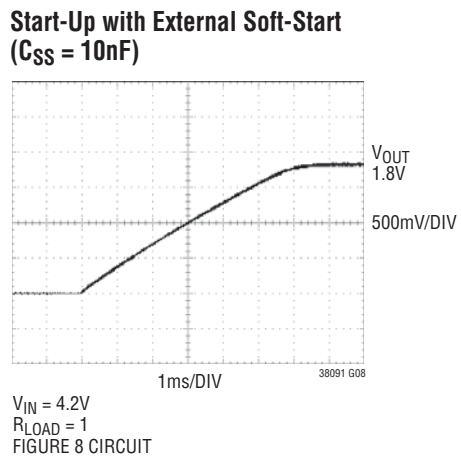
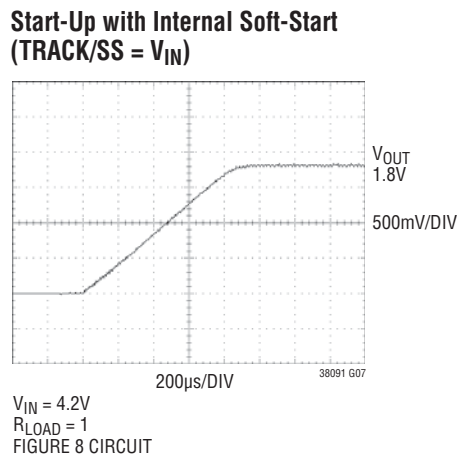
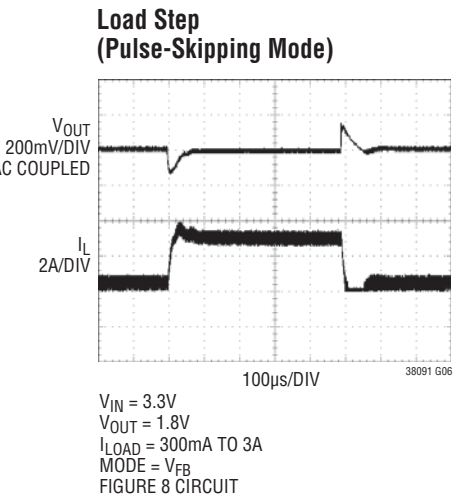
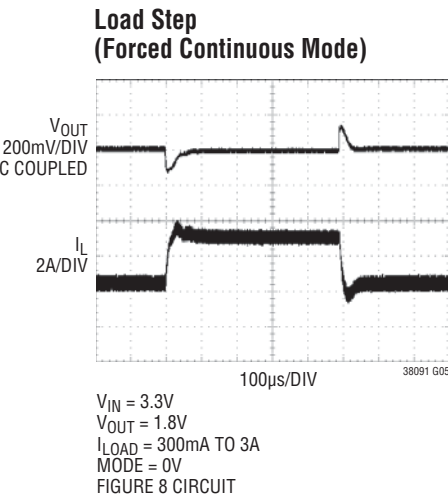
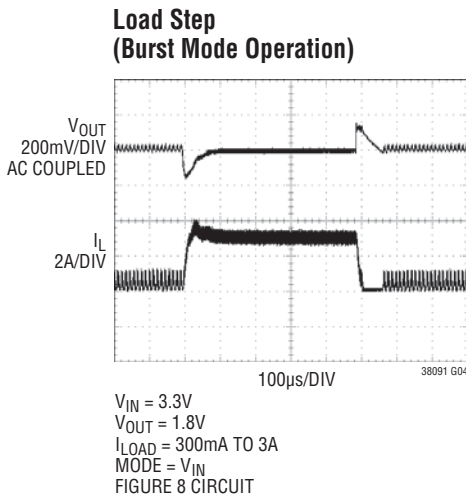
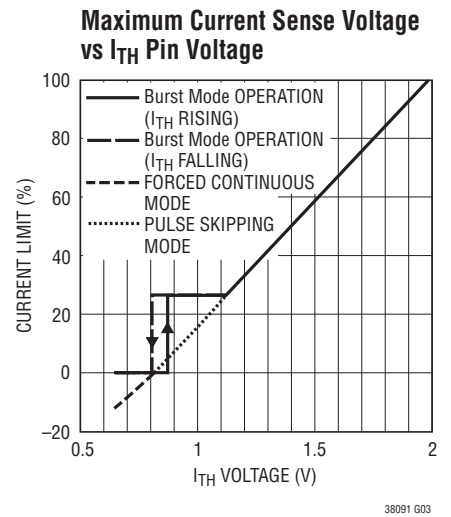
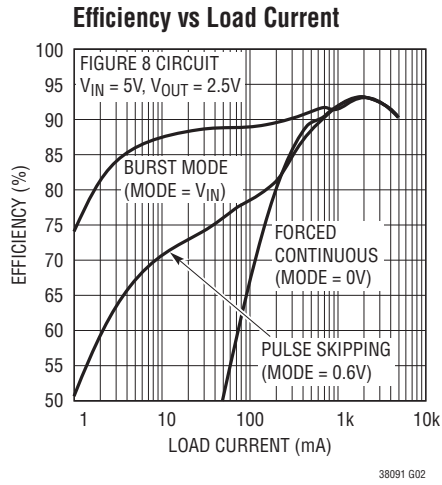
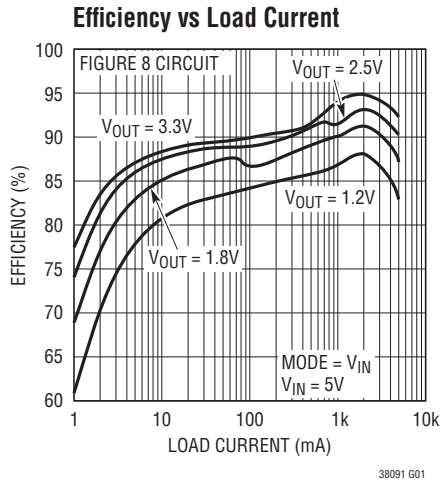

**TYPICAL PERFORMANCE CHARACTERISTICS**  $T_A = 25^\circ\text{C}$ , unless otherwise noted.

**Start-Up with Coincident Tracking**  
( $V_{OUT} = 0\text{V}$  at 0s)

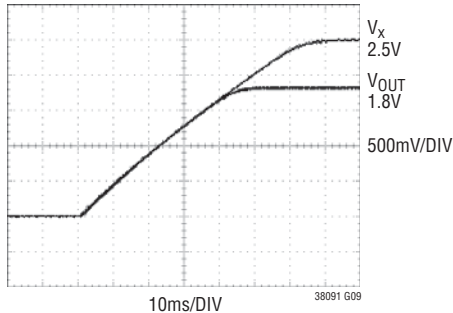

$V_{IN} = 4.2\text{V}$   
 $R_{TA} = 590$   
 $R_{TB} = 1.18\text{k}$   
FIGURE 8 CIRCUIT

**Start-Up with Coincident Tracking**  
( $V_{OUT} = 0.8\text{V}$  at 0s)

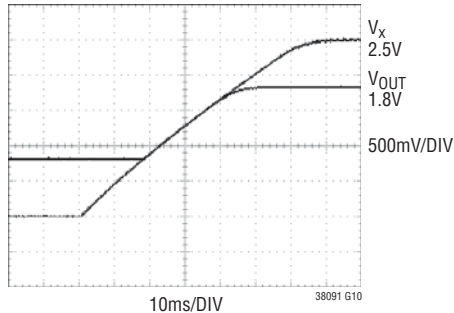

$V_{IN} = 4.2\text{V}$   
 $R_{TA} = 590$   
 $R_{TB} = 1.18\text{k}$   
FIGURE 8 CIRCUIT

**Start-Up with Ratiometric Tracking**  
( $V_{OUT} = 0\text{V}$  at 0s)

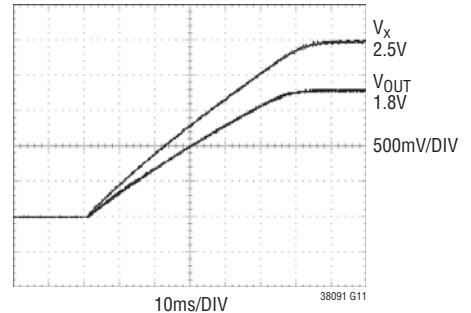

$V_{IN} = 4.2\text{V}$   
 $R_{TA} = 590$   
 $R_{TB} = 1.69\text{k}$   
FIGURE 8 CIRCUIT

**Regulated Feedback Voltage vs Temperature**

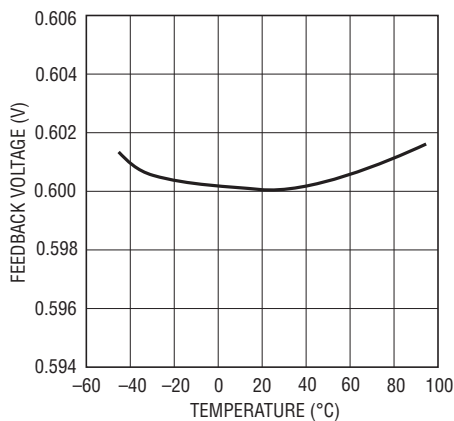

38091 G012

**Undervoltage Lockout Threshold vs Temperature**

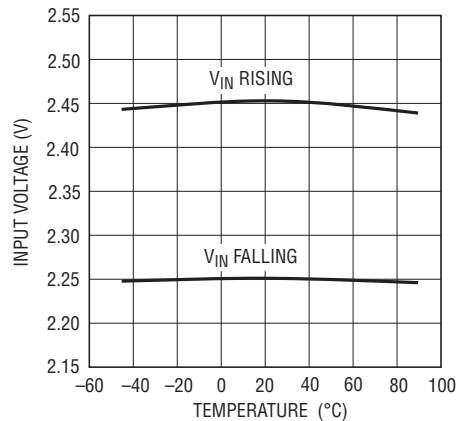

38091 G13

**Shutdown (RUN) Threshold vs Temperature**

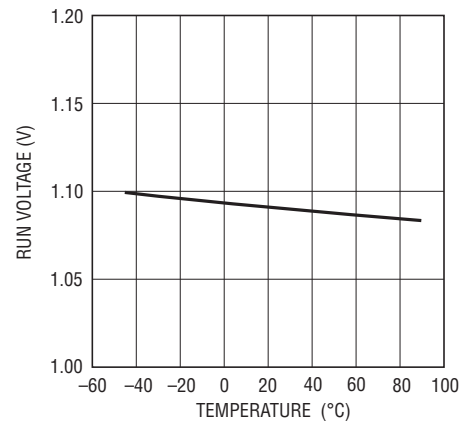

38091 G14

**Maximum Current Sense Threshold vs Temperature**

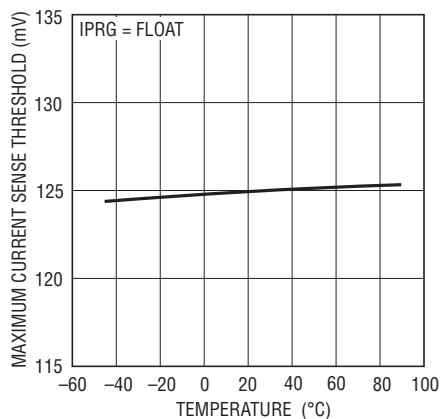

38091 G15

**TRACK/SS Start-Up Current vs Temperature**

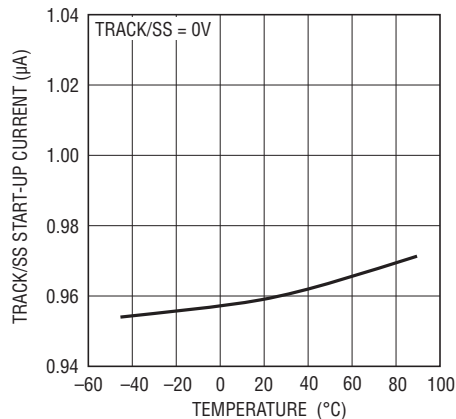

38091 G16

## TYPICAL PERFORMANCE CHARACTERISTICS $T_A = 25^\circ\text{C}$ , unless otherwise noted.

**Oscillator Frequency vs Temperature**

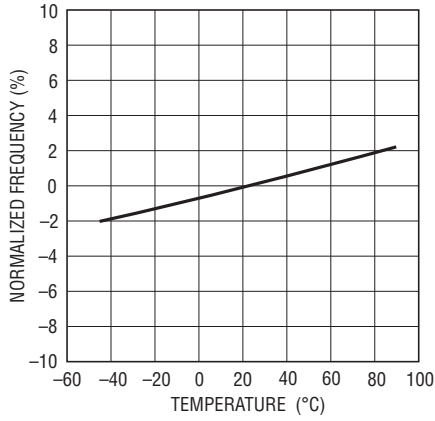

38091 G17

**Oscillator Frequency vs Input Voltage**

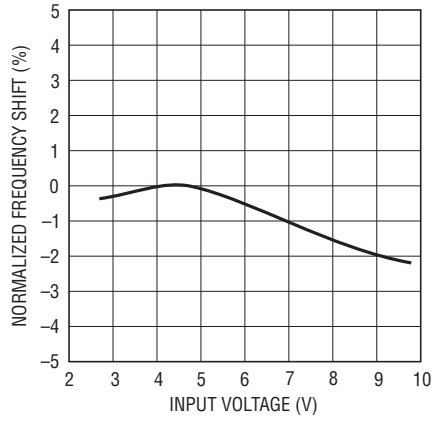

38091 G18

**Shutdown Quiescent Current vs Input Voltage**

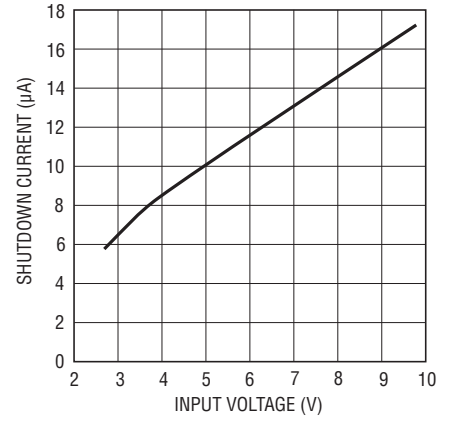

38091 G19

**Sleep Current vs Input Voltage**

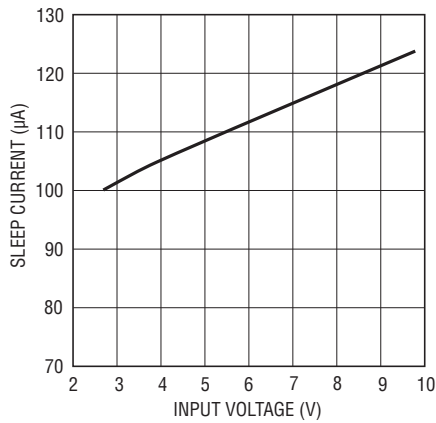

38091 G20

**TRACK/SS Start-Up Current vs TRACK/SS Voltage**

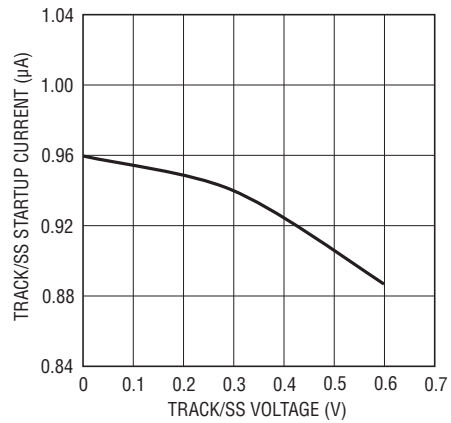

38091 G21

## PIN FUNCTIONS

**MODE (Pin 1):** This pin performs two functions: 1) auxiliary winding feedback input, and 2) Burst Mode operation, pulse skipping or forced continuous mode select.

To select Burst Mode operation at light loads, tie this pin to  $V_{IN}$ . Grounding this pin selects forced continuous operation which allows the inductor current to reverse. Tying this pin to  $V_{FB}$  selects pulse-skipping mode. **Do not leave this pin floating.**

**TRACK/SS (Pin 2):** Tracking Input for the Controller or Optional External Soft-Start Input. This pin allows the start-up of  $V_{OUT}$  to “track” the external voltage at this pin using an external resistor divider. Tying this pin to  $V_{IN}$  allows  $V_{OUT}$  to start up with the internal 0.74ms soft-start. An external soft-start can be programmed by connecting a capacitor between this pin and ground. **Do not leave this pin floating.**

**$V_{FB}$  (Pin 3):** Feedback Pin. This pin receives the remotely sensed feedback voltage for the controller from an external resistor divider across the output.

**$I_{TH}$  (Pin 4):** Current Threshold and Error Amplifier Compensation Point. Nominal operating range on this pin is from 0.7V to 2V. The voltage on this pin determines the threshold of the main current comparator.

**RUN (Pin 5):** Run Control Input. Forcing this pin below 1.1V shuts down the chip. Driving this pin to  $V_{IN}$  or releasing this pin enables the chip to start-up with the internal soft-start.

**IPRG (Pin 6):** Three-State Pin to Select Maximum Peak Sense Voltage Threshold. This pin selects the maximum allowed voltage drop between the  $V_{IN}$  and SW pins (i.e., the maximum allowed drop across the external P-channel MOSFET). Tie to  $V_{IN}$ , GND or float to select 204mV, 85mV or 125mV respectively.

**BG (Pin 7):** Bottom (NMOS) Gate Drive Output. This pin drives the gate of the external N-channel MOSFET. This pin has an output swing from PGND to  $V_{IN}$ .

**TG (Pin 8):** Top (PMOS) Gate Drive Output. This pin drives the gate of the external P-channel MOSFET. This pin has an output swing from PGND to  $V_{IN}$ .

**$V_{IN}$  (Pin 9):** Chip Signal Power Supply. This pin powers the entire chip, the gate drivers and serves as the positive input to the differential current comparator.

**SW (Pin 10):** Switch Node Connection to Inductor. This pin is also the negative input to the differential current comparator and an input to the reverse current comparator. Normally this pin is connected to the drain of the external P-channel MOSFET, the drain of the external N-channel MOSFET and the inductor.

**GND (Exposed Pad, Pin 11):** Ground connection for internal circuits, the gate drivers and the negative input to the reverse current comparator. The Exposed Pad must be soldered to the PCB ground.

FUNCTIONAL DIAGRAM

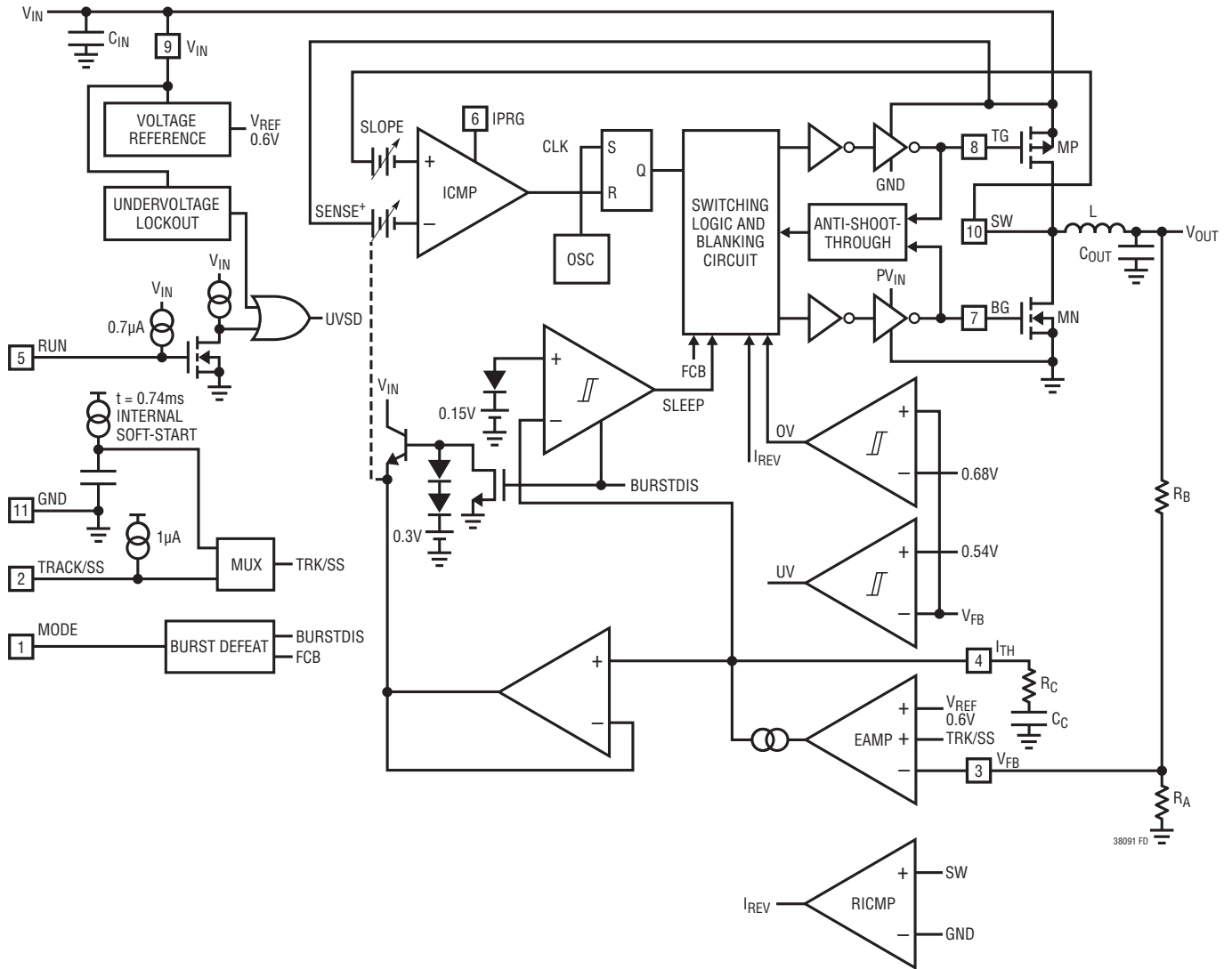

38091 FD

## OPERATION (Refer to Functional Diagram)

### Main Control Loop

The LTC3809-1 uses a constant frequency, current mode architecture. During normal operation, the top external P-channel power MOSFET is turned on when the clock sets the RS latch, and is turned off when the current comparator (ICMP) resets the latch. The peak inductor current at which ICMP resets the RS latch is determined by the voltage on the  $I_{TH}$  pin, which is driven by the output of the error amplifier (EAMP). The  $V_{FB}$  pin receives the output voltage feedback signal from an external resistor divider. This feedback signal is compared to the internal 0.6V reference voltage by the EAMP. When the load current increases, it causes a slight decrease in  $V_{FB}$  relative to the 0.6V reference, which in turn causes the  $I_{TH}$  voltage to increase until the average inductor current matches the new load current. While the top P-channel MOSFET is off, the bottom N-channel MOSFET is turned on until either the inductor current starts to reverse, as indicated by the current reversal comparator IRCMP, or the beginning of the next cycle.

### Shutdown, Soft-Start and Tracking Start-Up (RUN and TRACK/SS Pins)

The LTC3809-1 is shut down by pulling the RUN pin low. In shutdown, all controller functions are disabled and the chip draws only 9 $\mu$ A. The TG output is held high (off) and the BG output low (off) in shutdown. Releasing the RUN pin allows an internal 0.7 $\mu$ A current source to pull up the RUN pin to  $V_{IN}$ . The controller is enabled when the RUN pin reaches 1.1V.

The start-up of  $V_{OUT}$  is based on the three different connections on the TRACK/SS pin. The start-up of  $V_{OUT}$  is controlled by the LTC3809-1's internal soft-start when TRACK/SS is connected to  $V_{IN}$ . During soft-start, the error amplifier EAMP compares the feedback signal  $V_{FB}$  to the internal soft-start ramp (instead of the 0.6V reference), which rises linearly from 0V to 0.6V in about 1ms. This allows the output voltage to rise smoothly from 0V to its final value while maintaining control of the inductor current.

The 1ms soft-start time can be changed by connecting the optional external soft-start capacitor  $C_{SS}$  between the TRACK/SS and GND pins. When the controller is enabled

by releasing the RUN pin, the TRACK/SS pin is charged up by an internal 1 $\mu$ A current source and rises linearly from 0V to above 0.6V. The error amplifier EAMP compares the feedback signal  $V_{FB}$  to this ramp instead, and regulates  $V_{FB}$  linearly from 0V to 0.6V.

When the voltage on the TRACK/SS pin is less than the 0.6V internal reference, the LTC3809-1 regulates the  $V_{FB}$  voltage to the TRACK/SS pin instead of the 0.6V reference. Therefore  $V_{OUT}$  of the LTC3809-1 can track an external voltage  $V_X$  during start-up. Typically, a resistor divider on  $V_X$  is connected to the TRACK/SS pin to allow the start-up of  $V_{OUT}$  to "track" that of  $V_X$ . For coincident tracking during start-up, the regulated final value of  $V_X$  should be larger than that of  $V_{OUT}$ , and the resistor divider on  $V_X$  has the same ratio as the divider on  $V_{OUT}$  that is connected to  $V_{FB}$ . See detailed discussions in the Run and Soft-Start/Tracking Functions in the Applications Information Section.

### Light Load Operation (Burst Mode Operation, Continuous Conduction or Pulse-Skipping Mode) (MODE Pin)

The LTC3809-1 can be programmed for either high efficiency Burst Mode operation, forced continuous conduction mode or pulse-skipping mode at low load currents. To select Burst Mode operation, tie the MODE pin to  $V_{IN}$ . To select forced continuous operation, tie the MODE pin to a DC voltage below 0.4V (e.g., GND). Tying the MODE pin to a DC voltage above 0.4V and below 1.2V (e.g.,  $V_{FB}$ ) enables pulse-skipping mode. The 0.4V threshold between forced continuous operation and pulse-skipping mode can be used in secondary winding regulation as described in the Auxiliary Winding Control Using the MODE Pin discussion in the Applications Information section.

When the LTC3809-1 is in Burst Mode operation, the peak current in the inductor is set to approximately one-fourth of the maximum sense voltage even though the voltage on the  $I_{TH}$  pin indicates a lower value. If the average inductor current is higher than the load current, the EAMP will decrease the voltage on the  $I_{TH}$  pin. When the  $I_{TH}$  voltage drops below 0.85V, the internal SLEEP signal goes high and the external MOSFET is turned off.

## OPERATION (Refer to Functional Diagram)

In sleep mode, much of the internal circuitry is turned off, reducing the quiescent current that the LTC3809-1 draws. The load current is supplied by the output capacitor. As the output voltage decreases, the EAMP increases the  $I_{TH}$  voltage. When the  $I_{TH}$  voltage reaches 0.925V, the SLEEP signal goes low and the controller resumes normal operation by turning on the external P-channel MOSFET on the next cycle of the internal oscillator.

When the controller is enabled for Burst Mode or pulse-skipping operation, the inductor current is not allowed to reverse. Hence, the controller operates discontinuously. The reverse current comparator RICMP senses the drain-to-source voltage of the bottom external N-channel MOSFET. This MOSFET is turned off just before the inductor current reaches zero, preventing it from going negative.

In forced continuous operation, the inductor current is allowed to reverse at light loads or under large transient conditions. The peak inductor current is determined by the voltage on the  $I_{TH}$  pin. The P-channel MOSFET is turned on every cycle (constant frequency) regardless of the  $I_{TH}$  pin voltage. In this mode, the efficiency at light loads is lower than in Burst Mode operation. However, continuous mode has the advantages of lower output ripple and no noise at audio frequencies.

When the MODE pin is set to the  $V_{FB}$  Pin, the LTC3809-1 operates in PWM pulse-skipping mode at light loads. In this mode, the current comparator ICMP may remain tripped for several cycles and force the external P-channel MOSFET to stay off for the same number of cycles. The inductor current is not allowed to reverse (discontinuous operation). This mode, like forced continuous operation, exhibits low output ripple as well as low audible noise and reduced RF interference as compared to Burst Mode operation. However, it provides low current efficiency higher than forced continuous mode, but not nearly as

high as Burst Mode operation. During start-up or an undervoltage condition ( $V_{FB} \leq 0.54V$ ), the LTC3809-1 operates in pulse-skipping mode (no current reversal allowed), regardless of the state of the MODE pin.

### Short-Circuit and Current Limit Protection

The LTC3809-1 monitors the voltage drop  $\Delta V_{SC}$  (between the GND and SW pins) across the external N-channel MOSFET with the short-circuit current limit comparator. The allowed voltage is determined by:

$$\Delta V_{SC(MAX)} = A \cdot 90mV$$

where A is a constant determined by the state of the IPRG pin. Floating the IPRG pin selects  $A = 1$ ; tying IPRG to  $V_{IN}$  selects  $A = 5/3$ ; tying IPRG to GND selects  $A = 2/3$ .

The inductor current limit for short-circuit protection is determined by  $\Delta V_{SC(MAX)}$  and the on-resistance of the external N-channel MOSFET:

$$I_{SC} = \frac{\Delta V_{SC(MAX)}}{R_{DS(ON)}}$$

Once the inductor current exceeds  $I_{SC}$ , the short current comparator will shut off the external P-channel MOSFET until the inductor current drops below  $I_{SC}$ .

### Output Overvoltage Protection

As further protection, the overvoltage comparator (OVP) guards against transient overshoots, as well as other more serious conditions that may overvoltage the output. When the feedback voltage on the  $V_{FB}$  pin has risen 13.33% above the reference voltage of 0.6V, the external P-channel MOSFET is turned off and the N-channel MOSFET is turned on until the overvoltage is cleared.

## OPERATION (Refer to Functional Diagram)

### Dropout Operation

When the input supply voltage ( $V_{IN}$ ) approaches the output voltage, the rate of change of the inductor current while the external P-channel MOSFET is on (ON cycle) decreases. This reduction means that the P-channel MOSFET will remain on for more than one oscillator cycle if the inductor current has not ramped up to the threshold set by the EAMP on the  $I_{TH}$  pin. Further reduction in the input supply voltage will eventually cause the P-channel MOSFET to be turned on 100%; i.e., DC. The output voltage will then be determined by the input voltage minus the voltage drop across the P-channel MOSFET and the inductor.

### Undervoltage Lockout

To prevent operation of the P-channel MOSFET below safe input voltage levels, an undervoltage lockout is incorporated in the LTC3809-1. When the input supply voltage ( $V_{IN}$ ) drops below 2.25V, the external P- and N-channel MOSFETs and all internal circuits are turned off except for the undervoltage block, which draws only a few microamperes.

### Peak Current Sense Voltage Selection and Slope Compensation (IPRG Pin)

When the LTC3809-1 controller is operating below 20% duty cycle, the peak current sense voltage (between the  $V_{IN}$  and SW pins) allowed across the external P-channel MOSFET is determined by:

$$\Delta V_{SENSE(MAX)} = A \cdot \frac{V_{ITH} - 0.7V}{10}$$

where A is a constant determined by the state of the IPRG pin. Floating the IPRG pin selects  $A = 1$ ; tying IPRG to  $V_{IN}$  selects  $A = 5/3$ ; tying IPRG to GND selects  $A = 2/3$ . The maximum value of  $V_{ITH}$  is typically about 1.98V, so the maximum sense voltage allowed across the external P-channel MOSFET is 125mV, 85mV or 204mV for the three respective states of the IPRG pin.

However, once the controller's duty cycle exceeds 20%, slope compensation begins and effectively reduces the peak sense voltage by a scale factor (SF) given by the curve in Figure 1.

The peak inductor current is determined by the peak sense voltage and the on-resistance of the external P-channel MOSFET:

$$I_{PK} = \frac{\Delta V_{SENSE(MAX)}}{R_{DS(ON)}}$$

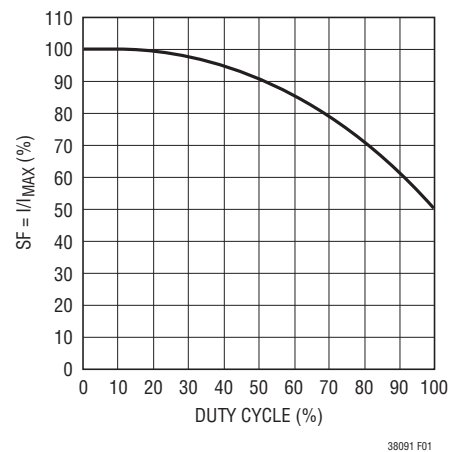

Figure 1. Maximum Peak Current vs Duty Cycle

## APPLICATIONS INFORMATION

The typical LTC3809-1 application circuit is shown in Figure 8. External component selection for the controller is driven by the load requirement and begins with the selection of the inductor and the power MOSFETs.

### Power MOSFET Selection

The LTC3809-1's controller requires two external power MOSFETs: a P-channel MOSFET for the topside (main) switch and a N-channel MOSFET for the bottom (synchronous) switch. The main selection criteria for the power MOSFETs are the breakdown voltage  $V_{BR(DSS)}$ , threshold voltage  $V_{GS(TH)}$ , on-resistance  $R_{DS(ON)}$ , reverse transfer capacitance  $C_{RSS}$ , turn-off delay  $t_{D(OFF)}$  and the total gate charge  $Q_G$ .

The gate drive voltage is the input supply voltage. Since the LTC3809-1 is designed for operation down to low input voltages, a sublogic level MOSFET ( $R_{DS(ON)}$  guaranteed at  $V_{GS} = 2.5V$ ) is required for applications that work close to this voltage. When these MOSFETs are used, make sure that the input supply to the LTC3809-1 is less than the absolute maximum MOSFET  $V_{GS}$  rating, which is typically 8V.

The P-channel MOSFET's on-resistance is chosen based on the required load current. The maximum average load current  $I_{OUT(MAX)}$  is equal to the peak inductor current minus half the peak-to-peak ripple current  $I_{RIPPLE}$ . The LTC3809-1's current comparator monitors the drain-to-source voltage  $V_{DS}$  of the top P-channel MOSFET, which is sensed between the  $V_{IN}$  and SW pins. The peak inductor current is limited by the current threshold, set by the voltage on the  $I_{TH}$  pin, of the current comparator. The voltage on the  $I_{TH}$  pin is internally clamped, which limits the maximum current sense threshold  $\Delta V_{SENSE(MAX)}$  to approximately 125mV when IPRG is floating (85mV when IPRG is tied low; 204mV when IPRG is tied high).

The output current that the LTC3809-1 can provide is given by:

$$I_{OUT(MAX)} = \frac{\Delta V_{SENSE(MAX)} - I_{RIPPLE}}{R_{DS(ON)} \cdot 2}$$

where  $I_{RIPPLE}$  is the inductor peak-to-peak ripple current (see Inductor Value Calculation).

A reasonable starting point is setting ripple current  $I_{RIPPLE}$  to be 40% of  $I_{OUT(MAX)}$ . Rearranging the above equation yields:

$$R_{DS(ON)MAX} = \frac{5}{6} \cdot \frac{\Delta V_{SENSE(MAX)}}{I_{OUT(MAX)}} \text{ for Duty Cycle } < 20\%$$

However, for operation above 20% duty cycle, slope compensation has to be taken into consideration to select the appropriate value of  $R_{DS(ON)}$  to provide the required amount of load current:

$$R_{DS(ON)MAX} = \frac{5}{6} \cdot SF \cdot \frac{\Delta V_{SENSE(MAX)}}{I_{OUT(MAX)}}$$

where SF is a scale factor whose value is obtained from the curve in Figure 1.

These must be further derated to take into account the significant variation in on-resistance with temperature. The following equation is a good guide for determining the required  $R_{DS(ON)MAX}$  at 25°C (manufacturer's specification), allowing some margin for variations in the LTC3809-1 and external component values:

$$R_{DS(ON)MAX} = \frac{5}{6} \cdot 0.9 \cdot SF \cdot \frac{\Delta V_{SENSE(MAX)}}{I_{OUT(MAX)} \cdot \rho_T}$$

The  $\rho_T$  is a normalizing term accounting for the temperature variation in on-resistance, which is typically about 0.4%/°C, as shown in Figure 2. Junction-to-case temperature  $T_{JC}$  is about 10°C in most applications. For a maximum ambient temperature of 70°C, using  $\rho_{80°C} \sim 1.3$  in the above equation is a reasonable choice.

The N-channel MOSFET's on resistance is chosen based on the short-circuit current limit ( $I_{SC}$ ). The LTC3809-1's short-circuit current limit comparator monitors the drain-to-source voltage  $V_{DS}$  of the bottom N-channel MOSFET, which is sensed between the GND and SW pins.

## APPLICATIONS INFORMATION

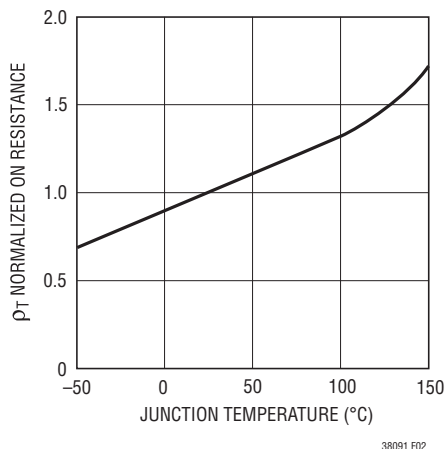
Figure 2.  $R_{DS(ON)}$  vs Temperature

The short-circuit current sense threshold  $\Delta V_{SC}$  is set approximately 90mV when IPRG is floating (60mV when IPRG is tied low; 150mV when IPRG is tied high). The on-resistance of N-channel MOSFET is determined by:

$$R_{DS(ON)MAX} = \frac{\Delta V_{SC}}{I_{SC(PEAK)}}$$

The short-circuit current limit ( $I_{SC(PEAK)}$ ) should be larger than the  $I_{OUT(MAX)}$  with some margin to avoid interfering with the peak current sensing loop. On the other hand, in order to prevent the MOSFETs from excessive heating and the inductor from saturation,  $I_{SC(PEAK)}$  should be smaller than the minimum value of their current ratings. A reasonable range is:

$$I_{OUT(MAX)} < I_{SC(PEAK)} < I_{RATING(MIN)}$$

Therefore, the on-resistance of N-channel MOSFET should be chosen within the following range:

$$\frac{\Delta V_{SC}}{I_{RATING(MIN)}} < R_{DS(ON)} < \frac{\Delta V_{SC}}{I_{OUT(MAX)}}$$

where  $\Delta V_{SC}$  is 90mV, 60mV or 150mV with IPRG being floated, tied to GND or  $V_{IN}$  respectively.

The power dissipated in the MOSFET strongly depends on its respective duty cycles and load current. When the LTC3809-1 is operating in continuous mode, the duty cycles for the MOSFETs are:

$$\text{Top P-Channel Duty Cycle} = \frac{V_{OUT}}{V_{IN}}$$

$$\text{Bottom N-Channel Duty Cycle} = \frac{V_{IN} - V_{OUT}}{V_{IN}}$$

The MOSFET power dissipations at maximum output current are:

$$P_{TOP} = \frac{V_{OUT}}{V_{IN}} \cdot I_{OUT(MAX)}^2 \cdot \rho_T \cdot R_{DS(ON)} + 2 \cdot V_{IN}^2 \cdot I_{OUT(MAX)} \cdot C_{RSS} \cdot f$$

$$P_{BOT} = \frac{V_{IN} - V_{OUT}}{V_{IN}} \cdot I_{OUT(MAX)}^2 \cdot \rho_T \cdot R_{DS(ON)}$$

Both MOSFETs have  $I^2R$  losses and the  $P_{TOP}$  equation includes an additional term for transition losses, which are largest at high input voltages. The bottom MOSFET losses are greatest at high input voltage or during a short-circuit when the bottom duty cycle is 100%.

The LTC3809-1 utilizes a non-overlapping, anti-shoot-through gate drive control scheme to ensure that the P- and N-channel MOSFETs are not turned on at the same time. To function properly, the control scheme requires that the MOSFETs used are intended for DC/DC switching applications. Many power MOSFETs, particularly P-channel MOSFETs, are intended to be used as static switches and therefore are slow to turn on or off.

Reasonable starting criteria for selecting the P-channel MOSFET are that it must typically have a gate charge ( $Q_G$ ) less than 25nC to 30nC (at 4.5 $V_{GS}$ ) and a turn-off delay ( $t_{D(OFF)}$ ) of less than approximately 140ns. However, due to differences in test and specification methods of various MOSFET manufacturers, and in the variations in  $Q_G$  and  $t_{D(OFF)}$  with gate drive ( $V_{IN}$ ) voltage, the P-channel MOSFET ultimately should be evaluated in the actual LTC3809-1 application circuit to ensure proper operation.

Shoot-through between the P-channel and N-channel MOSFETs can most easily be spotted by monitoring the input supply current. As the input supply voltage increases, if the input supply current increases dramatically, then the likely cause is shoot-through. Note that some MOSFETs

## APPLICATIONS INFORMATION

that do not work well at high input voltages (e.g.,  $V_{IN} > 5V$ ) may work fine at lower voltages (e.g., 3.3V).

Selecting the N-channel MOSFET is typically easier, since for a given  $R_{DS(ON)}$ , the gate charge and turn-on and turn-off delays are much smaller than for a P-channel MOSFET.

### Inductor Value Calculation

Given the desired input and output voltages, the inductor value and operating frequency,  $f_{OSC}$ , directly determine the inductor's peak-to-peak ripple current:

$$I_{RIPPLE} = \frac{V_{OUT}}{V_{IN}} \cdot \frac{V_{IN} - V_{OUT}}{f_{OSC} \cdot L}$$

Lower ripple current reduces core losses in the inductor, ESR losses in the output capacitors and output voltage ripple. Thus, highest efficiency operation is obtained at low frequency with a small ripple current. Achieving this, however, requires a large inductor.

A reasonable starting point is to choose a ripple current that is about 40% of  $I_{OUT(MAX)}$ . Note that the largest ripple current occurs at the highest input voltage. To guarantee that ripple current does not exceed a specified maximum, the inductor should be chosen according to:

$$L \geq \frac{V_{IN} - V_{OUT}}{f_{OSC} \cdot I_{RIPPLE}} \cdot \frac{V_{OUT}}{V_{IN}}$$

### Burst Mode Operation Considerations

The choice of  $R_{DS(ON)}$  and inductor value also determines the load current at which the LTC3809-1 enters Burst Mode operation. When bursting, the controller clamps the peak inductor current to approximately:

$$I_{BURST(PEAK)} = \frac{1}{4} \cdot \frac{\Delta V_{SENSE(MAX)}}{R_{DS(ON)}}$$

The corresponding average current depends on the amount of ripple current. Lower inductor values (higher  $I_{RIPPLE}$ ) will reduce the load current at which Burst Mode operation begins.

The ripple current is normally set so that the inductor current is continuous during the burst periods. Therefore,

$$I_{RIPPLE} \leq I_{BURST(PEAK)}$$

This implies a minimum inductance of:

$$L_{MIN} \leq \frac{V_{IN} - V_{OUT}}{f_{OSC} \cdot I_{BURST(PEAK)}} \cdot \frac{V_{OUT}}{V_{IN}}$$

A smaller value than  $L_{MIN}$  could be used in the circuit, although the inductor current will not be continuous during burst periods, which will result in slightly lower efficiency. In general, though, it is a good idea to keep  $I_{RIPPLE}$  comparable to  $I_{BURST(PEAK)}$ .

### Inductor Core Selection

Once the value of L is known, the type of inductor must be selected. Actual core loss is independent of core size for a fixed inductor value, but is very dependent on the inductance selected. As inductance increases, core losses go down. Unfortunately, increased inductance requires more turns of wire and therefore copper losses will increase.

Ferrite designs have very low core losses and are preferred at high switching frequencies, so design goals can concentrate on copper loss and preventing saturation. Ferrite core material saturates "hard", which means that inductance collapses abruptly when the peak design current is exceeded. Core saturation results in an abrupt increase in inductor ripple current and consequent output voltage ripple. Do not allow the core to saturate!

## APPLICATIONS INFORMATION

Different core materials and shapes will change the size/current and price/current relationship of an inductor. Toroid or shielded pot cores in ferrite or permalloy materials are small and don't radiate much energy, but generally cost more than powdered iron core inductors with similar characteristics. The choice of which style inductor to use mainly depends on the price vs size requirements and any radiated field/EMI requirements. New designs for surface mount inductors are available from Coiltronics, Coilcraft, Toko and Sumida.

### Schottky Diode Selection (Optional)

The schottky diode D in Figure 9 conducts current during the dead time between the conduction of the power MOSFETs. This prevents the body diode of the bottom N-channel MOSFET from turning on and storing charge during the dead time, which could cost as much as 1% in efficiency. A 1A Schottky diode is generally a good size for most LTC3809-1 applications, since it conducts a relatively small average current. Larger diode results in additional transition losses due to its larger junction capacitance. This diode may be omitted if the efficiency loss can be tolerated.

### C<sub>IN</sub> and C<sub>OUT</sub> Selection

In continuous mode, the source current of the P-channel MOSFET is a square wave of duty cycle ( $V_{OUT}/V_{IN}$ ). To prevent large voltage transients, a low ESR input capacitor sized for the maximum RMS current must be used. The maximum RMS capacitor current is given by:

$$C_{IN} \text{ Required } I_{RMS} \approx I_{MAX} \cdot \frac{V_{OUT} \cdot (V_{IN} - V_{OUT})^{1/2}}{V_{IN}}$$

This formula has a maximum value at  $V_{IN} = 2V_{OUT}$ , where  $I_{RMS} = I_{OUT}/2$ . This simple worst-case condition is commonly used for design because even significant deviations do not offer much relief. Note that capacitor manufacturer's ripple current ratings are often based on 2000 hours of life. This makes it advisable to further derate the capacitor or to choose a capacitor rated at a higher temperature than required. Several capacitors may be paralleled to meet the size or height requirements in the design. Due to the high operating frequency of the LTC3809-1, ceramic capacitors can also be used for C<sub>IN</sub>. Always consult the manufacturer if there is any question.

The selection of C<sub>OUT</sub> is driven by the effective series resistance (ESR). Typically, once the ESR requirement is satisfied, the capacitance is adequate for filtering. The output ripple ( $\Delta V_{OUT}$ ) is approximated by:

$$\Delta V_{OUT} \approx I_{RIPPLE} \cdot \left( ESR + \frac{1}{8 \cdot f \cdot C_{OUT}} \right)$$

where f is the operating frequency, C<sub>OUT</sub> is the output capacitance and I<sub>RIPPLE</sub> is the ripple current in the inductor. The output ripple is highest at maximum input voltage since I<sub>RIPPLE</sub> increase with input voltage.

### Setting Output Voltage

The LTC3809-1 output voltage is set by an external feedback resistor divider carefully placed across the output, as shown in Figure 3. The regulated output voltage is determined by:

$$V_{OUT} = 0.6V \cdot \left( 1 + \frac{R_B}{R_A} \right)$$

## APPLICATIONS INFORMATION

For most applications, a 59k resistor is suggested for  $R_A$ . In applications where minimizing the quiescent current is critical,  $R_A$  should be made bigger to limit the feedback divider current. If  $R_B$  then results in very high impedance, it may be beneficial to bypass  $R_B$  with a 50pF to 100pF capacitor  $C_{FF}$ .

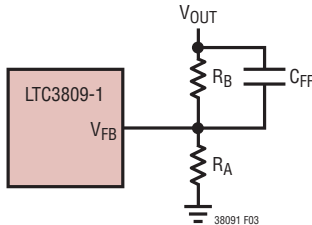

Figure 3. Setting Output Voltage

### Run and Soft-Start/Tracking Functions

The LTC3809-1 has a low power shutdown mode which is controlled by the RUN pin. Pulling the RUN pin below 1.1V puts the LTC3809-1 into a low quiescent current shutdown mode ( $I_Q = 9\mu A$ ). Releasing the RUN pin, an internal 0.7 $\mu A$  (at  $V_{IN} = 4.2V$ ) current source will pull the RUN pin up to  $V_{IN}$ , which enables the controller. The RUN pin can be driven directly from logic as showed in Figure 4.

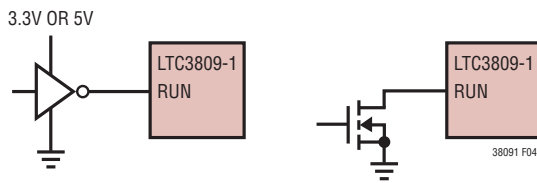

Figure 4. RUN Pin Interfacing

Once the controller is enabled, the start-up of  $V_{OUT}$  is controlled by the state of the TRACK/SS pin. If the TRACK/SS pin is connected to  $V_{IN}$ , the start-up of  $V_{OUT}$  is controlled by internal soft-start, which slowly ramps the positive reference to the error amplifier from 0V to 0.6V, allowing  $V_{OUT}$  to rise smoothly from 0V to its final value. The default internal soft-start time is around 0.74ms. The soft-start time can be changed by placing a capacitor between the TRACK/SS pin and GND. In this case, the soft-start time will be approximately:

$$t_{SS} = C_{SS} \cdot \frac{600mV}{1\mu A}$$

where 1 $\mu A$  is an internal current source which is always on.

When the voltage on the TRACK/SS pin is less than the internal 0.6V reference, the LTC3809-1 regulates the  $V_{FB}$  voltage to the TRACK/SS pin voltage instead of 0.6V. Therefore the start-up of  $V_{OUT}$  can ratiometrically track an external voltage  $V_X$ , according to a ratio set by a resistor divider at TRACK/SS pin (Figure 5a). The ratiometric relation between  $V_{OUT}$  and  $V_X$  is (Figure 5c):

$$\frac{V_{OUT}}{V_X} = \frac{R_{TA}}{R_A} \cdot \frac{R_A + R_B}{R_{TA} + R_{TB}}$$

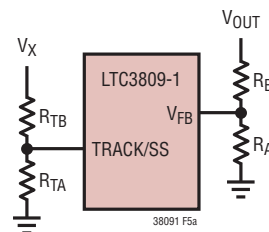
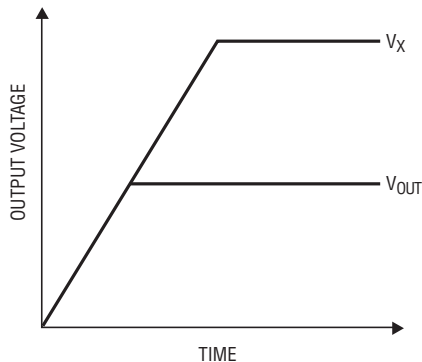
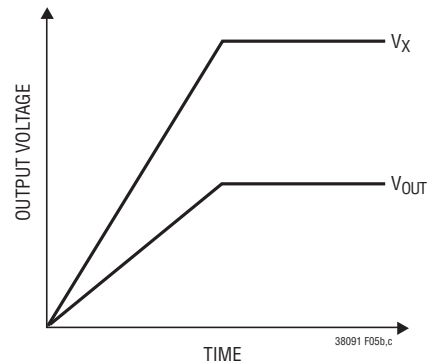

Figure 5a. Using the TRACK/SS Pin to Track  $V_X$

## APPLICATIONS INFORMATION



(5b) Coincident Tracking



(5c) Ratiometric Tracking

Figure 5b and 5c. Two Different Modes of Output Voltage Tracking

For coincident tracking ( $V_{OUT} = V_X$  during start-up),

$$R_{TA} = R_A, R_{TB} = R_B$$

$V_X$  should always be greater than  $V_{OUT}$  when using the tracking function of TRACK/SS pin.

The internal current source ( $1\mu A$ ), which is for external soft-start, will cause a tracking error at  $V_{OUT}$ . For example, if a 59k resistor is chosen for  $R_{TA}$ , the  $R_{TA}$  current will be about  $10\mu A$  ( $600mV/59k$ ). In this case, the  $1\mu A$  internal current source will cause about 10% ( $1\mu A/10\mu A \cdot 100\%$ ) tracking error, which is about 60mV ( $600mV \cdot 10\%$ ) referred to  $V_{FB}$ . This is acceptable for most applications. If a better tracking accuracy is required, the value of  $R_{TA}$  should be reduced.

Table 1 summarizes the different states in which the TRACK/SS can be used.

Table 1. The States of the TRACK/SS Pin

TRACK/SS Pin	FREQUENCY
Capacitor $C_{SS}$	External Soft-Start
$V_{IN}$	Internal Soft-Start
Resistor Divider	$V_{OUT}$ Tracking an External Voltage $V_X$

### Auxiliary Winding Control Using the MODE Pin

The MODE pin can be used as an auxiliary feedback to provide a means of regulating a flyback winding output. When this pin drops below its ground-referenced 0.4V threshold, continuous mode operation is forced.

During continuous mode, current flows continuously in the transformer primary side. The auxiliary winding draws current only when the bottom synchronous N-channel MOSFET is on. When primary load currents are low and/or the  $V_{IN}/V_{OUT}$  ratio is close to unity, the synchronous MOSFET may not be on for a sufficient amount of time to transfer power from the output capacitor to the auxiliary load. Forced continuous operation will support an auxiliary winding as long as there is a sufficient synchronous MOSFET duty factor. The MODE input pin removes the requirement that power must be drawn from the transformer primary side in order to extract power from the auxiliary winding. With the loop in continuous mode, the auxiliary output may nominally be loaded without regard to the primary output load.

## APPLICATIONS INFORMATION

The auxiliary output voltage  $V_{AUX}$  is normally set, as shown in Figure 6, by the turns ratio  $N$  of the transformer:

$$V_{AUX} = (N + 1) \cdot V_{OUT}$$

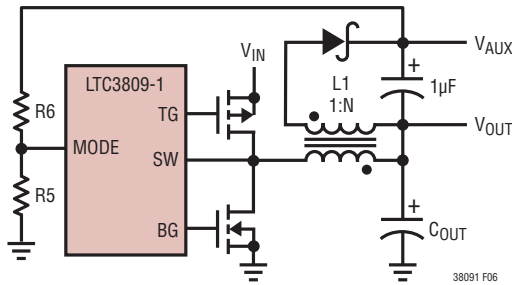

Figure 6. Auxiliary Output Loop Connection

However, if the controller goes into pulse-skipping operation and halts switching due to a light primary load current, then  $V_{AUX}$  will droop. An external resistor divider from  $V_{AUX}$  to the MODE sets a minimum voltage  $V_{AUX(MIN)}$ :

$$V_{AUX(MIN)} = 0.4V \cdot \left(1 + \frac{R6}{R5}\right)$$

If  $V_{AUX}$  drops below this value, the MODE voltage forces temporary continuous switching operation until  $V_{AUX}$  is again above its minimum.

### Fault Condition: Short-Circuit and Current Limit

If the LTC3809-1's load current exceeds the short-circuit current limit ( $I_{SC}$ ), which is set by the short-circuit sense threshold ( $\Delta V_{SC}$ ) and the on resistance ( $R_{DS(ON)}$ ) of bottom N-channel MOSFET, the top P-channel MOSFET is turned off and will not be turned on at the next clock cycle unless the load current decreases below  $I_{SC}$ . In this case, the controller's switching frequency is decreased and the output is regulated by short-circuit (current limit) protection.

In a hard short ( $V_{OUT} = 0V$ ), the top P-channel MOSFET is turned off and kept off until the short-circuit condition is cleared. In this case, there is no current path from input supply ( $V_{IN}$ ) to either  $V_{OUT}$  or GND, which prevents excessive MOSFET and inductor heating.

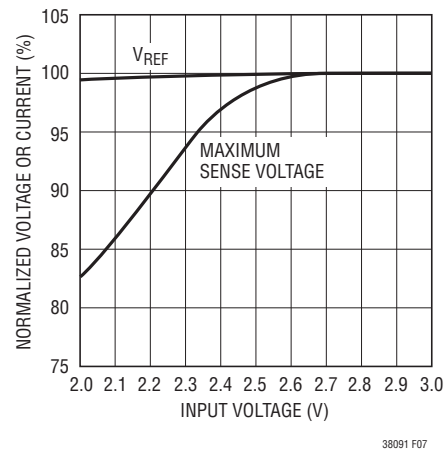

Figure 7. Line Regulation of  $V_{REF}$  and Maximum Sense Voltage

### Low Supply Voltage

Although the LTC3809-1 can function down to below 2.4V, the maximum allowable output current is reduced as  $V_{IN}$  decreases below 3V. Figure 7 shows the amount of change as the supply is reduced down to 2.4V. Also shown is the effect on  $V_{REF}$ .

### Minimum On-Time Considerations

Minimum on-time,  $t_{ON(MIN)}$  is the smallest amount of time that the LTC3809-1 is capable of turning the top P-channel MOSFET on. It is determined by internal timing delays and the gate charge required to turn on the top MOSFET. Low duty cycle and high frequency applications may approach the minimum on-time limit and care should be taken to ensure that:

$$t_{ON(MIN)} < \frac{V_{OUT}}{f_{OSC} \cdot V_{IN}}$$

## APPLICATIONS INFORMATION

If the duty cycle falls below what can be accommodated by the minimum on-time, the LTC3809-1 will begin to skip cycles (unless forced continuous mode is selected). The output voltage will continue to be regulated, but the ripple current and ripple voltage will increase. The minimum on-time for the LTC3809-1 is typically about 210ns. However, as the peak sense voltage ( $I_{L(PEAK)} \cdot R_{DS(ON)}$ ) decreases, the minimum on-time gradually increases up to about 260ns. This is of particular concern in forced continuous applications with low ripple current at light loads. If forced continuous mode is selected and the duty cycle falls below the minimum on time requirement, the output will be regulated by overvoltage protection.

### Efficiency Considerations

The efficiency of a switching regulator is equal to the output power divided by the input power times 100%. It is often useful to analyze individual losses to determine what is limiting efficiency and which change would produce the most improvement. Efficiency can be expressed as:

$$\text{Efficiency} = 100\% - (L1 + L2 + L3 + \dots)$$

where L1, L2, etc. are the individual losses as a percentage of input power.

Although all dissipative elements in the circuit produce losses, four main sources usually account for most of the losses in LTC3809-1 circuits: 1) LTC3809-1 DC bias current, 2) MOSFET gate-charge current, 3)  $I^2R$  losses and 4) transition losses.

1) The  $V_{IN}$  (pin) current is the DC supply current, given in the Electrical Characteristics, which excludes MOSFET driver currents.  $V_{IN}$  current results in a small loss that increases with  $V_{IN}$ .

2) MOSFET gate-charge current results from switching the gate capacitance of the power MOSFET. Each time a MOSFET gate is switched from low to high to low again, a packet of charge  $dQ$  moves from  $V_{IN}$  to ground. The resulting  $dQ/dt$  is a current out of  $V_{IN}$ , which is typically much larger than the DC supply current. In continuous mode,  $I_{GATECHG} = f \cdot Q_P$ .

3)  $I^2R$  losses are calculated from the DC resistances of the MOSFETs, inductor and/or sense resistor. In continuous mode, the average output current flows through L but is “chopped” between the top P-channel MOSFET and the bottom N-channel MOSFET. The MOSFET  $R_{DS(ON)}$  multiplied by duty cycle can be summed with the resistance of L to obtain  $I^2R$  losses.

4) Transition losses apply to the external MOSFET and increase with higher operating frequencies and input voltages. Transition losses can be estimated from:

$$\text{Transition Loss} = 2 \cdot V_{IN}^2 \cdot I_{O(MAX)} \cdot C_{RSS} \cdot f$$

Other losses, including  $C_{IN}$  and  $C_{OUT}$  ESR dissipative losses and inductor core losses, generally account for less than 2% total additional loss.

### Checking Transient Response

The regulator loop response can be checked by looking at the load transient response. Switching regulators take several cycles to respond to a step in load current. When a load step occurs,  $V_{OUT}$  immediately shifts by an amount equal to  $(\Delta I_{LOAD}) \cdot (ESR)$ , where ESR is the effective series resistance of  $C_{OUT}$ .  $\Delta I_{LOAD}$  also begins to charge or discharge  $C_{OUT}$  generating a feedback error signal used by the regulator to return  $V_{OUT}$  to its steady-state value. During this recovery time,  $V_{OUT}$  can be monitored for overshoot or ringing that would indicate a stability problem. OPTI-LOOP compensation allows the transient response to be optimized over a wide range of output capacitance and ESR values.

The  $I_{TH}$  series  $R_C$ - $C_C$  filter (see Functional Diagram) sets the dominant pole-zero loop compensation.

The  $I_{TH}$  external components showed in the figure on the first page of this data sheet will provide adequate compensation for most applications. The values can be modified slightly (from 0.2 to 5 times their suggested values) to optimize transient response once the final PC layout is done and the particular output capacitor type and value have been determined. The output capacitor needs to be decided upon because the various types and values determine the loop feedback factor gain and phase. An output current

## APPLICATIONS INFORMATION

pulse of 20% to 100% of full load current having a rise time of 1 $\mu$ s to 10 $\mu$ s will produce output voltage and I<sub>TH</sub> pin waveforms that will give a sense of the overall loop stability. The gain of the loop will be increased by increasing R<sub>C</sub> and the bandwidth of the loop will be increased by decreasing C<sub>C</sub>. The output voltage settling behavior is related to the stability of the closed-loop system and will demonstrate the actual overall supply performance. For a detailed explanation of optimizing the compensation components, including a review of control loop theory, refer to Application Note 76.

A second, more severe transient is caused by switching in loads with large (>1 $\mu$ F) supply bypass capacitors. The discharged bypass capacitors are effectively put in parallel with C<sub>OUT</sub>, causing a rapid drop in V<sub>OUT</sub>. No regulator can deliver enough current to prevent this problem if the load switch resistance is low and it is driven quickly. The only solution is to limit the rise time of the switch drive so that the load rise time is limited to approximately (25) • (C<sub>LOAD</sub>). Thus a 10 $\mu$ F capacitor would require a 250 $\mu$ s rise time, limiting the charging current to about 200mA.

### Design Example

As a design example, assume V<sub>IN</sub> will be operating from a maximum of 4.2V down to a minimum of 2.75V (powered by a single lithium-ion battery). Load current requirement is a maximum of 2A, but most of the time it will be in a standby mode requiring only 2mA. Efficiency at both low and high load currents is important. Burst Mode operation at light loads is desired. Output voltage is 1.8V. The IPRG pin will be left floating, so the maximum current sense threshold  $\Delta V_{SENSE(MAX)}$  is approximately 125mV.

$$\text{Maximum Duty Cycle} = \frac{V_{OUT}}{V_{IN(MIN)}} = 65.5\%$$

From Figure 1, SF = 82%.

$$R_{DS(ON)MAX} = \frac{5}{6} \cdot 0.9 \cdot SF \cdot \frac{\Delta V_{SENSE(MAX)}}{I_{OUT(MAX)} \cdot \rho_T} = 0.032\Omega$$

A 0.032 $\Omega$  P-channel MOSFET in Si7540DP is close to this value.

The N-channel MOSFET in Si7540DP has 0.017 $\Omega$  R<sub>DS(ON)</sub>. The short-circuit current is:

$$I_{SC} = \frac{90\text{mV}}{0.017\Omega} = 5.3\text{A}$$

So the inductor current rating should be higher than 5.3A.

The LTC3809-1 operates at a frequency of 550kHz. For continuous Burst Mode operation with 600mA I<sub>RIPPLE</sub>, the required minimum inductor value is:

$$L_{MIN} = \frac{1.8\text{V}}{550\text{kHz} \cdot 600\text{mA}} \cdot \left( 1 - \frac{1.8\text{V}}{2.75\text{V}} \right) = 1.88\mu\text{H}$$

A 6A 2.2 $\mu$ H inductor works well for this application.

C<sub>IN</sub> will require an RMS current rating of at least 1A at temperature. A C<sub>OUT</sub> with 0.1 $\Omega$  ESR will cause approximately 60mV output ripple.

### PC Board Layout Checklist

When laying out the printed circuit board, use the following checklist to ensure proper operation of the LTC3809-1.

- The power loop (input capacitor, MOSFET, inductor, output capacitor) should be as small as possible and isolated as much as possible from LTC3809-1.
- Put the feedback resistors close to the V<sub>FB</sub> pins. The I<sub>TH</sub> compensation components should also be very close to the LTC3809-1.
- The current sense traces should be Kelvin connections right at the P-channel MOSFET source and drain.
- Keeping the switch node (SW) and the gate driver nodes (TG, BG) away from the small-signal components, especially the feedback resistors, and I<sub>TH</sub> compensation components.

TYPICAL APPLICATIONS

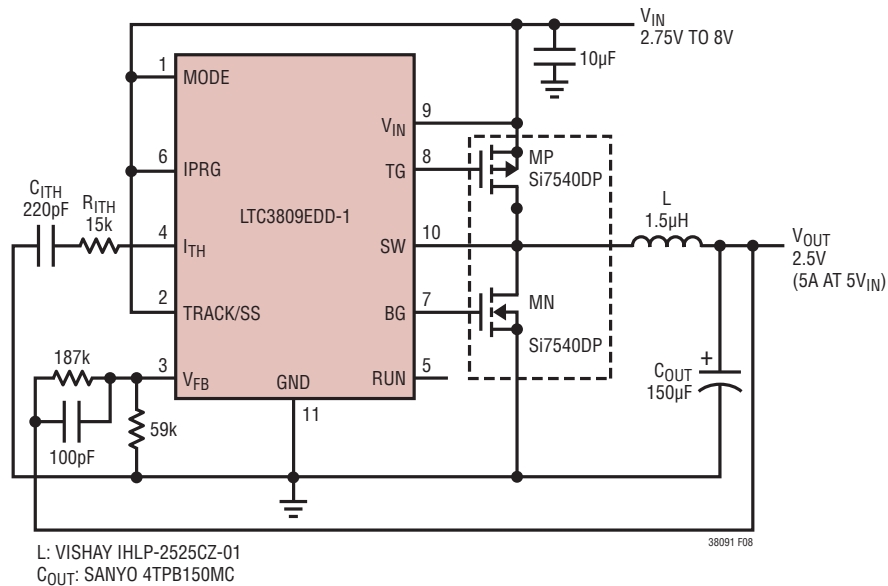

Figure 8. 550kHz, Synchronous DC/DC Converter with Internal Soft-Start

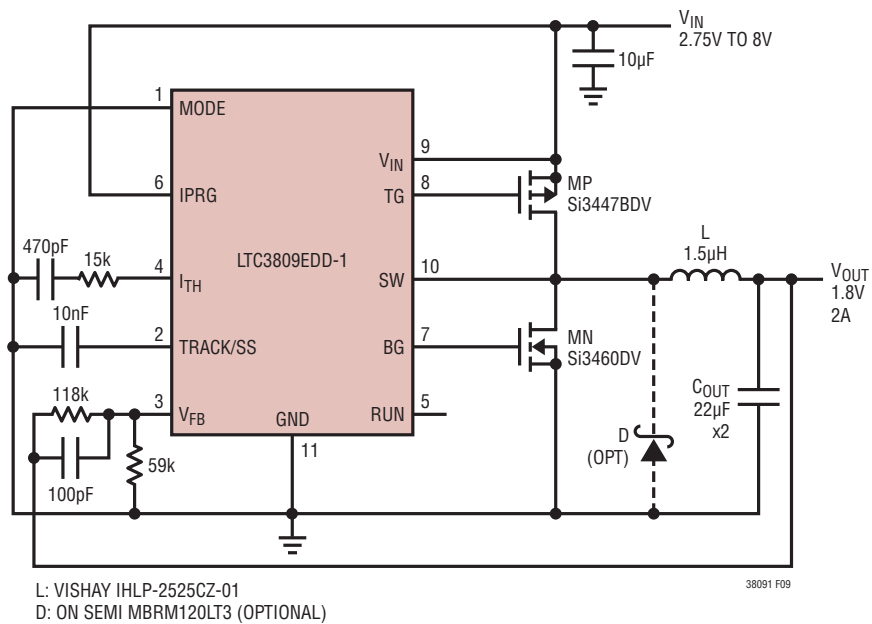
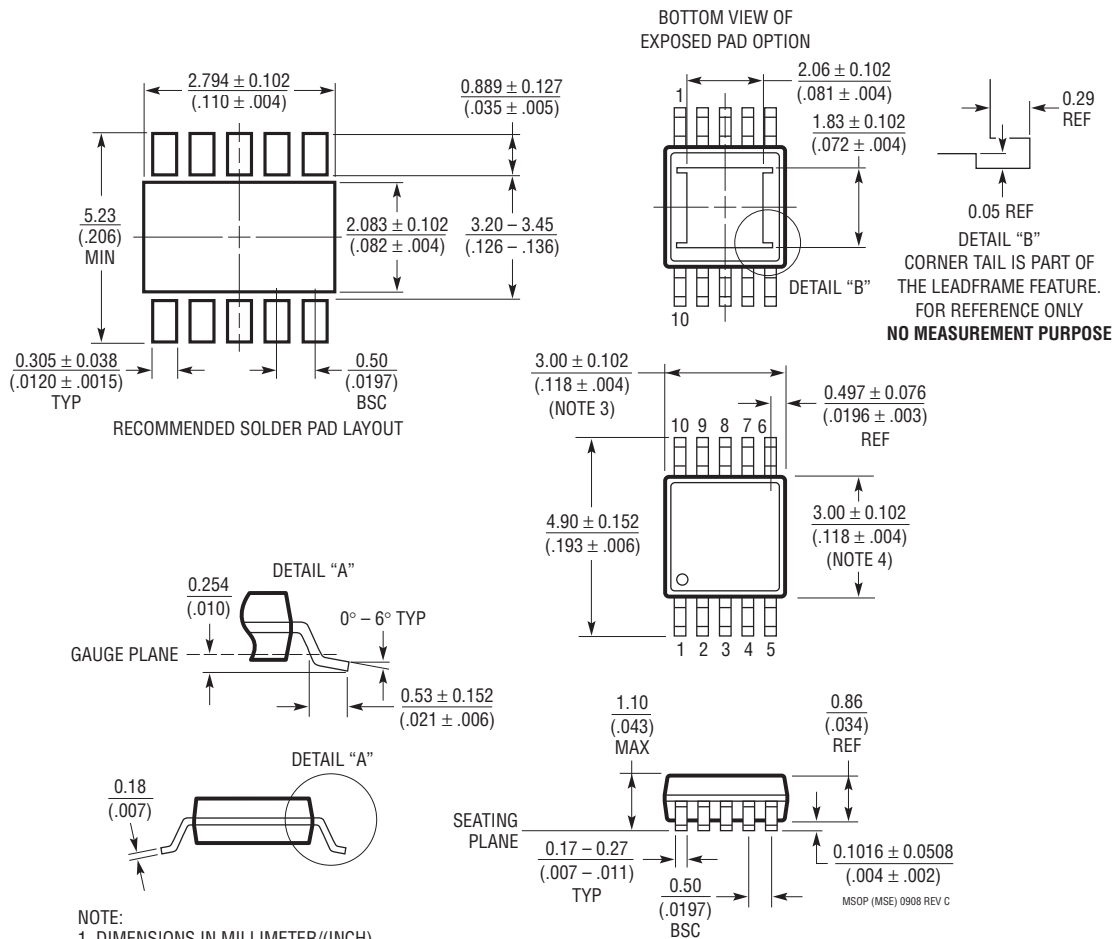

Figure 9. 550kHz, Synchronous DC/DC Converter with External Soft-Start, Ceramic Output Capacitor



# PACKAGE DESCRIPTION

## MSE Package 10-Lead Plastic MSOP, Exposed Die Pad (Reference LTC DWG # 05-08-1664 Rev C)



- NOTE:
1. DIMENSIONS IN MILLIMETER/(INCH)
  2. DRAWING NOT TO SCALE
  3. DIMENSION DOES NOT INCLUDE MOLD FLASH, PROTRUSIONS OR GATE BURRS. MOLD FLASH, PROTRUSIONS OR GATE BURRS SHALL NOT EXCEED 0.152mm (.006") PER SIDE
  4. DIMENSION DOES NOT INCLUDE INTERLEAD FLASH OR PROTRUSIONS. INTERLEAD FLASH OR PROTRUSIONS SHALL NOT EXCEED 0.152mm (.006") PER SIDE
  5. LEAD COPLANARITY (BOTTOM OF LEADS AFTER FORMING) SHALL BE 0.102mm (.004") MAX



## RELATED PARTS

PART NUMBER	DESCRIPTION	COMMENTS
LTC1628/LTC3728	Dual High Efficiency, 2-Phase Synchronous Step Down Controllers	Constant Frequency, Standby, 5V and 3.3V LDOs, $V_{IN}$ to 36V,
LTC1735	High Efficiency Synchronous Step-Down Controller	Burst Mode Operation, 16-Pin Narrow SSOP, Fault Protection, $3.5V \leq V_{IN} \leq 36V$
LTC1773	Synchronous Step-Down Controller	$2.65V \leq V_{IN} \leq 8.5V$ , $I_{OUT}$ Up to 4A, 10-Lead MSOP
LTC1778	No $R_{SENSE}$ , Synchronous Step-Down Controller	Current Mode Operation Without Sense Resistor, Fast Transient Response, $4V \leq V_{IN} \leq 36V$
LTC1872	Constant Frequency Current Mode Step-Up Controller	$2.5V \leq V_{IN} \leq 9.8V$ , SOT-23 Package, 550kHz
LTC3411	1.25A ( $I_{OUT}$ ), 4MHz, Synchronous Step-Down DC/DC Converter	95% Efficiency, $V_{IN}$ : 2.5V to 5.5V, $V_{OUT} = 0.8V$ , $I_Q = 60\mu A$ , $I_{SD} = <1\mu A$ , MS Package
LTC3412	2.5A ( $I_{OUT}$ ), 4MHz, Synchronous Step-Down DC/DC Converter	95% Efficiency, $V_{IN}$ : 2.5V to 5.5V, $V_{OUT} = 0.8V$ , $I_Q = 60\mu A$ , $I_{SD} = <1\mu A$ , TSSOP-16E Package
LTC3416	4A, 4MHz, Monolithic Synchronous Step-Down Regulator	Tracking Input to Provide Easy Supply Sequencing, $2.25V \leq V_{IN} \leq 5.5V$ , 20-Lead TSSOP Package
LTC3418	8A, 4MHz, Monolithic Synchronous Regulator	Tracking Input to Provide Easy Supply Sequencing, $2.25V \leq V_{IN} \leq 5.5V$ , QFN Package
LTC3701	2-Phase, Low Input Voltage Dual Step-Down DC/DC Controller	$2.5V \leq V_{IN} \leq 9.8V$ , 550kHz, PGOOD, PLL, 16-Lead SSOP
LTC3708	2-Phase, No $R_{SENSE}$ , Dual Synchronous Controller with Output Tracking	Constant On-Time Dual Controller, $V_{IN}$ Up to 36V, Very Low Duty Cycle Operation, 5mm $\times$ 5mm QFN Package
LTC3736/LTC3736-2	2-Phase, No $R_{SENSE}$ , Dual Synchronous Controller with Output Tracking	$2.75V \leq V_{IN} \leq 9.8V$ , $0.6V \leq V_{OUT} \leq V_{IN}$ , 4mm $\times$ 4mm QFN
LTC3736-1	Low EMI, 2-Phase, No $R_{SENSE}$ , Dual Synchronous Controller with Output Tracking	Integrated Spread Spectrum for 20dB Lower "Noise," $2.75V \leq V_{IN} \leq 9.8V$
LTC3737	2-Phase, No $R_{SENSE}$ , Dual DC/DC Controller with Output Tracking	$2.75V \leq V_{IN} \leq 9.8V$ , $0.6V \leq V_{OUT} \leq V_{IN}$ , 4mm $\times$ 4mm QFN
LTC3772	Micropower, No $R_{SENSE}$ , Constant Frequency Step-Down Controller	40 $\mu A$ No-Load $I_Q$ , Non-Synchronous, $2.75V \leq V_{IN} \leq 9.8V$ , 550kHz, 3mm $\times$ 2mm DFN or 8-Lead TSOT-23 Packages.
LTC3776	Dual, 2-Phase, No $R_{SENSE}$ , Synchronous Controller for DDR/QDR Memory Termination	Provides $V_{DDQ}$ and $V_{TT}$ with One IC, $2.75V \leq V_{IN} \leq 9.8V$ , Adjustable Constant Frequency with PLL Up to 850kHz, Spread Spectrum Operation, 4mm $\times$ 4mm QFN and 24-Lead SSOP Packages
LTC3808	No $R_{SENSE}$ , Low EMI, Synchronous Controller with Output Tracking	$2.75V \leq V_{IN} \leq 9.8V$ , 4mm $\times$ 3mm DFN, Spread Spectrum for 20dB Lower Peak Noise
LTC3809	No $R_{SENSE}$ , Low EMI, Synchronous DC/DC Controller	$2.75V \leq V_{IN} \leq 9.8V$ , 3mm $\times$ 3mm DFN and 10-Lead MSOPE Packages, Spread Spectrum for 20dB Lower Peak Noise

PolyPhase is a trademark of Linear Technology Corporation.

## Looking for pricing, stock, or lifecycle information?

Click below to explore more details on WIN SOURCE:

-  [View LTC3809EMSE-1#TRPBF on WIN SOURCE](#)
-  [Linear Technology](#) Information

## Optimize Your Supply Chain with WIN SOURCE Solutions

-  Global Sourcing Solution
-  Obsolete Management
-  Cost Control Management
-  Shortage Management
-  Alternative Solution
-  Excess Inventory Management