



**THE DATASHEET OF
LTM8046IY#PBF**



3.1V_{IN} to 31V_{IN}, 2kVAC Isolated DC/DC μ Module Converter

FEATURES

- 2kVAC Isolated μ Module Converter (Tested to 3kVDC)
- UL 60950 Recognized , File E464570
- Wide Input Voltage Range: 3.1V to 31V
- 5V at 550mA from 24V_{IN}
- 1.8V to 12V Output Voltage
- Current Mode Control
- Programmable Soft-Start
- User Configurable Undervoltage Lockout
- SnPb or RoHS Compliant Finish
- 9mm × 15mm × 4.92mm BGA Package

APPLICATIONS

- Industrial Sensors
- Industrial Switches
- Ground Loop Mitigation

DESCRIPTION

The LTM[®]8046 is an isolated flyback DC/DC μ Module[®] (micromodule) converter. The LTM8046 has an isolation rating of 2kVAC. Included in the package are the switching controller, power switches, transformer, and all support components. Operating over an input voltage range of 3.1V to 31V, the LTM8046 supports an output voltage range of 1.8V to 12V, set by one resistor. Only output, input, and bias capacitors are needed to finish the design. An optional capacitor can be used to set the soft-start period.

The LTM8046 is packaged in a 9mm × 15mm × 4.92mm over-molded ball grid array (BGA) package suitable for automated assembly by standard surface mount equipment. The LTM8046 is available with SnPb (BGA) or RoHS compliant terminal finish.

 LT, LTC, LTM, Linear Technology, the Linear logo and μ Module are registered trademarks of Linear Technology Corporation. All other trademarks are the property of their respective owners.

TYPICAL APPLICATION

2kV Isolated Low Noise μ Module Regulator

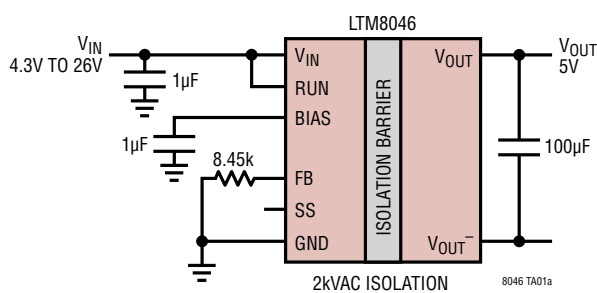

Maximum Output Current vs V_{IN}

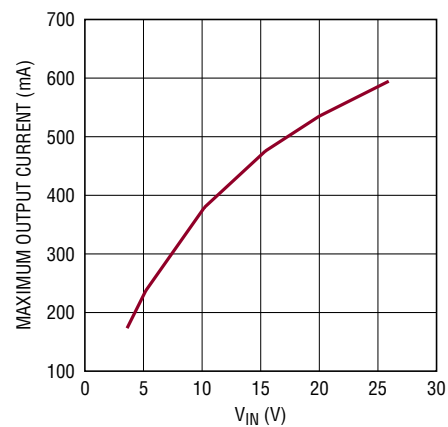

LTM8046

ABSOLUTE MAXIMUM RATINGS

(Note 1)

V_{IN} , RUN	32V
FB, SS	5V
V_{OUT} Relative to V_{OUT}^-	16V
$V_{IN} + 2V_{OUT}$ (Note 5)	36V
BIAS	$V_{IN} + 0.1V$
GND to V_{OUT}^- Isolation (Note 2)	2kVAC
Maximum Internal Temperature (Note 3)	125°C
Peak Solder Reflow Body Temperature	245°C

PIN CONFIGURATION

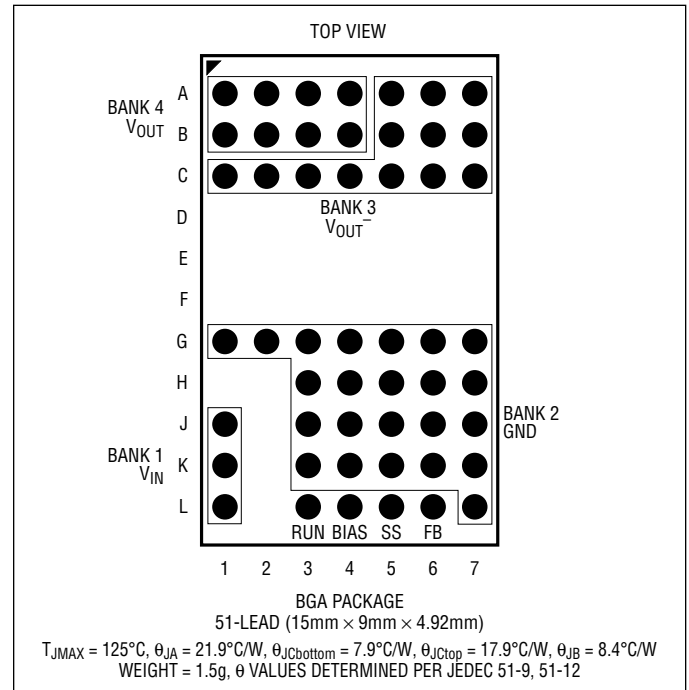

ORDER INFORMATION

PART NUMBER	PAD OR BALL FINISH	PART MARKING*		PACKAGE TYPE	MSL RATING	TEMPERATURE RANGE (See Note 3)
		DEVICE	FINISH CODE			
LTM8046EY#PBF	SAC305 (RoHS)	LTM8046Y	e1	BGA	3	-40°C to 125°C
LTM8046IY#PBF	SAC305 (RoHS)	LTM8046Y	e1	BGA	3	-40°C to 125°C
LTM8046IY	SnPb (63/37)	LTM8046Y	e0	BGA	3	-40°C to 125°C
LTM8046MPY#PBF	SAC305 (RoHS)	LTM8046Y	e1	BGA	3	-55°C to 125°C
LTM8046MPY	SnPb (63/37)	LTM8046Y	e0	BGA	3	-55°C to 125°C

Consult Marketing for parts specified with wider operating temperature ranges. *Device temperature grade is indicated by a label on the shipping container. Pad or ball finish code is per IPC/JEDEC J-STD-609.

- Pb-free and Non-Pb-free Part Markings:
www.linear.com/leadfree

- Recommended LGA and BGA PCB Assembly and Manufacturing Procedures:
www.linear.com/umodule/pcbassembly
- LGA and BGA Package and Tray Drawings:
www.linear.com/packaging

ELECTRICAL CHARACTERISTICS

The ● denotes the specifications which apply over the full internal operating temperature range, otherwise specifications are at $T_A = 25^\circ\text{C}$, $\text{RUN} = 12\text{V}$ (Note 3).

PARAMETER	CONDITIONS	MIN	TYP	MAX	UNITS
Minimum Input DC Voltage	BIAS = V_{IN} , $V_{\text{RUN}} = 2\text{V}$ BIAS Open, $V_{\text{RUN}} = 2\text{V}$	●		3.1	V
		●		4.3	V
V_{OUT} DC Voltage	$R_{\text{FB}} = 14.7\text{k}$ $R_{\text{FB}} = 8.45\text{k}$ $R_{\text{FB}} = 3.83\text{k}$	●	4.75	2.5	V
				5	V
				12	V
V_{IN} Quiescent Current	$V_{\text{RUN}} = 0\text{V}$			1	μA
V_{OUT} Line Regulation	$6\text{V} \leq V_{\text{IN}} \leq 31\text{V}$, $I_{\text{OUT}} = 0.15\text{A}$, $V_{\text{RUN}} = 2\text{V}$		1		%
V_{OUT} Load Regulation	$0.05\text{A} \leq I_{\text{OUT}} \leq 0.4\text{A}$, $V_{\text{RUN}} = 2\text{V}$		1.5		%
V_{OUT} Ripple (RMS)	$I_{\text{OUT}} = 0.1\text{A}$, $\text{BW} = 1\text{MHz}$		20		mV
Isolation Test Voltage	(Note 2)	3000			VDC
Input Short Circuit Current	V_{OUT} Shorted		30		mA
RUN Pin Input Threshold	VRUN Pin Rising	1.18	1.24	1.30	V
RUN Pin Current	$V_{\text{RUN}} = 1\text{V}$ $V_{\text{RUN}} = 1.3\text{V}$		2.5		μA
			0.1		μA
SS Threshold			0.7		V
SS Sourcing Current	SS = 0V		-8		μA
BIAS Current	$V_{\text{IN}} = 12\text{V}$, $\text{BIAS} = 5\text{V}$, $I_{\text{OUT}} = 100\text{mA}$		10		mA
Minimum BIAS Voltage (Note 4)	$I_{\text{OUT}} = 100\text{mA}$			3.1	V

Note 1: Stresses beyond those listed under Absolute Maximum Ratings may cause permanent damage to the device. Exposure to any Absolute Maximum Rating condition for extended periods may affect device reliability and lifetime.

Note 2: The LTM8046 isolation is tested at 3kVDC for one second.

Note 3: The LTM8046E is guaranteed to meet performance specifications from 0°C to 125°C . Specifications over the -40°C to 125°C internal temperature range are assured by design, characterization and correlation with statistical process controls. LTM8046I is guaranteed to meet specifications over the full -40°C to 125°C internal operating temperature range. The LTM8046MP is guaranteed to meet specifications over the full -55°C to 125°C internal operating temperature range. Note that the maximum internal temperature is determined by specific operating conditions in conjunction with board layout, the rated package thermal resistance and other environmental factors.

Note 4: This is the BIAS pin voltage at which the internal circuitry is powered through the BIAS pin and not the integrated regulator. See BIAS Pin Considerations for details.

Note 5: $V_{\text{IN}} + 2V_{\text{OUT}}$ is defined as the sum of the voltage between ($V_{\text{IN}} - \text{GND}$) added to twice the voltage between ($V_{\text{OUT}} - V_{\text{OUT}^-}$).

TYPICAL PERFORMANCE CHARACTERISTICS

1.8V_{OUT} Efficiency vs Output Current

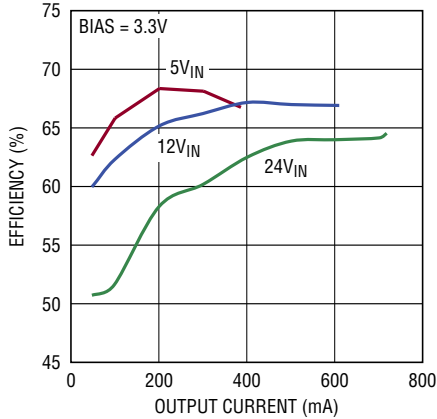

2.5V_{OUT} Efficiency vs Output Current

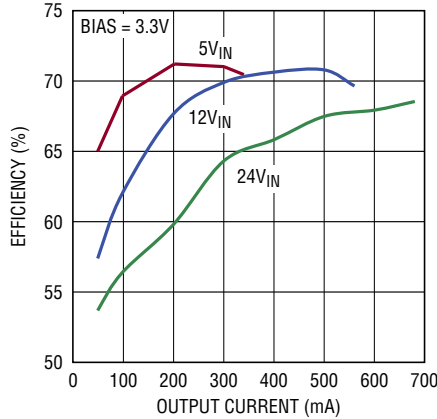

3.3V_{OUT} Efficiency vs Output Current

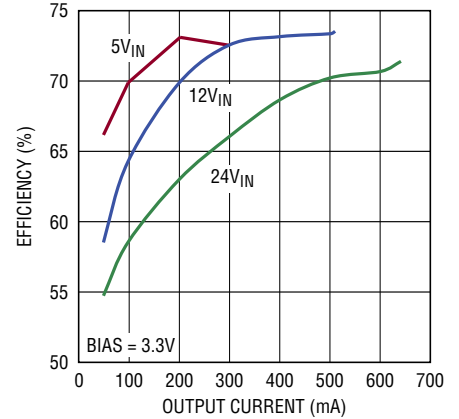

5V_{OUT} Efficiency vs Output Current

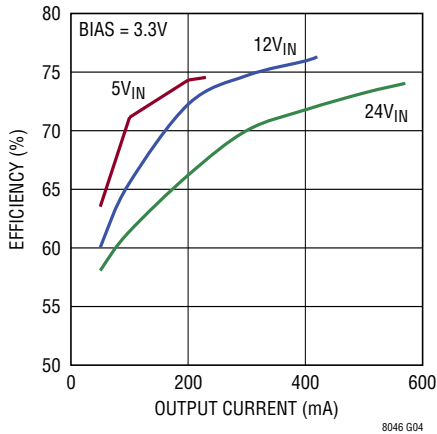

8V_{OUT} Efficiency vs Output Current

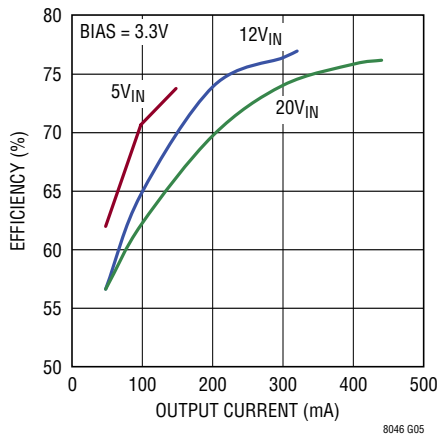

12V_{OUT} Efficiency vs Output Current

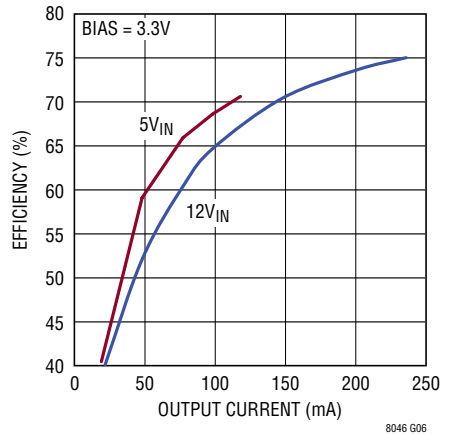

1.8V_{OUT} Input Current vs Output Current

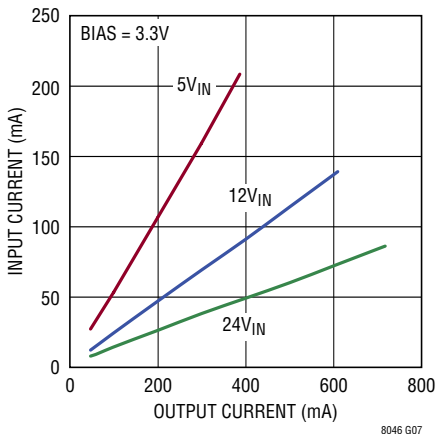

2.5V_{OUT} Input Current vs Output Current

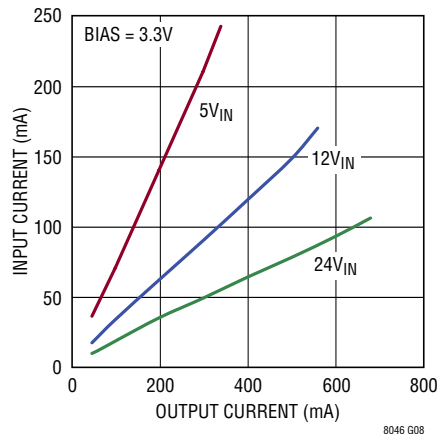

3.3V_{OUT} Input Current vs Output Current

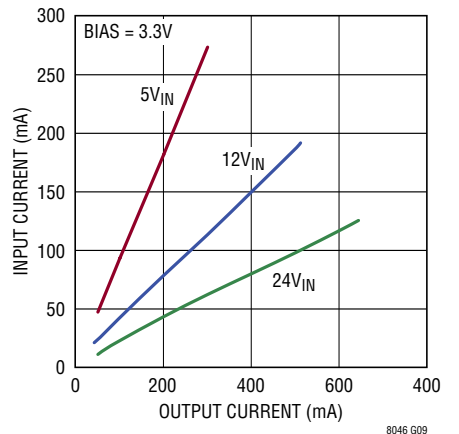

TYPICAL PERFORMANCE CHARACTERISTICS

5V_{OUT} Input Current vs Output Current

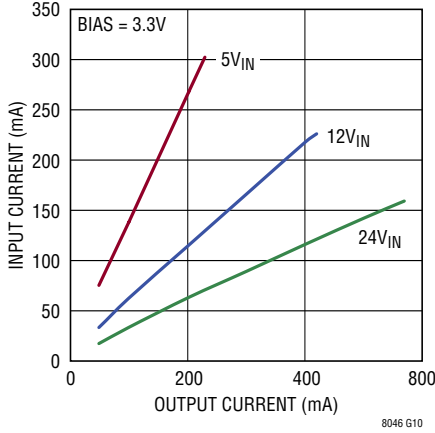

8046 G10

8V_{OUT} Input Current vs Output Current

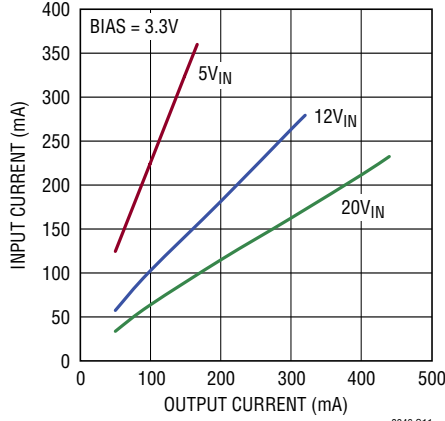

8046 G11

12V_{OUT} Input Current vs Output Current

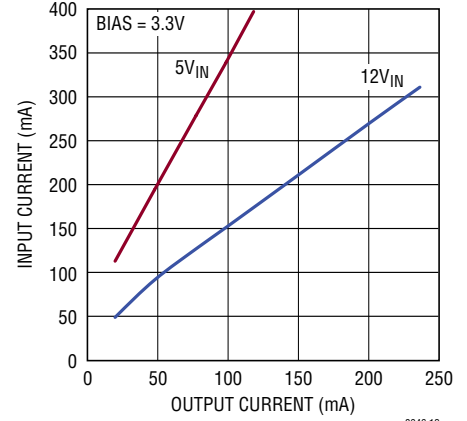

8046 G12

1.8V_{OUT} Bias Current vs Output Current

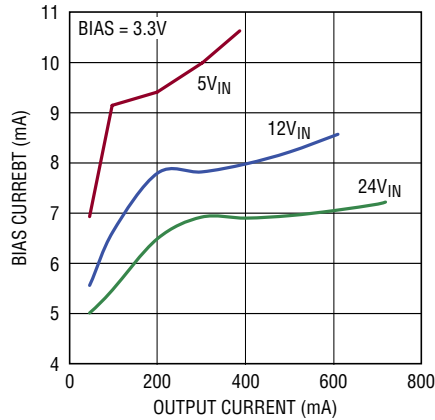

8046 G13

2.5V_{OUT} Bias Current vs Output Current

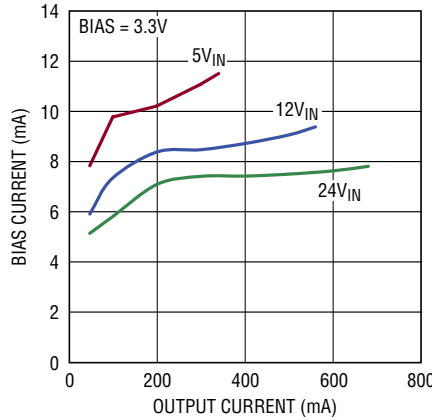

8046 G14

3.3V_{OUT} Bias Current vs Output Current

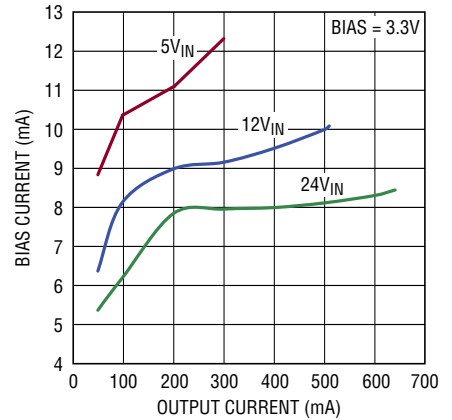

8046 G15

5V_{OUT} Bias Current vs Output Current

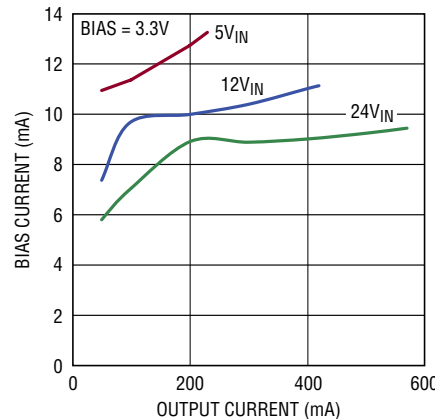

8046 G16

8V_{OUT} Bias Current vs Output Current

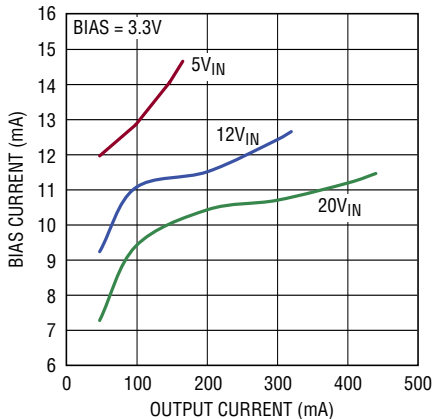

8046 G17

12V_{OUT} Bias Current vs Output Current

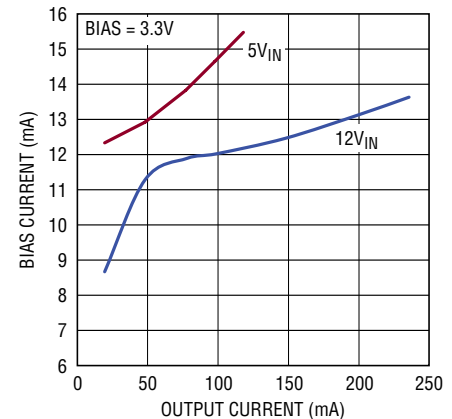

8046 G18

TYPICAL PERFORMANCE CHARACTERISTICS

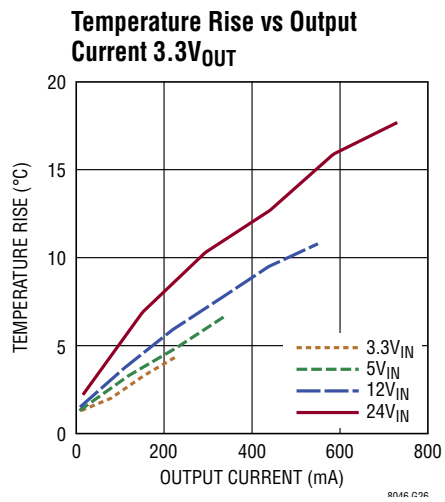
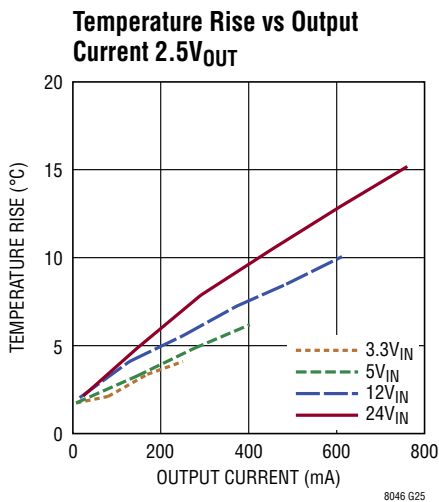
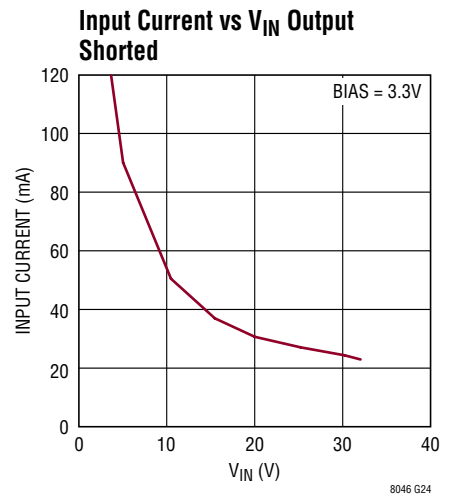
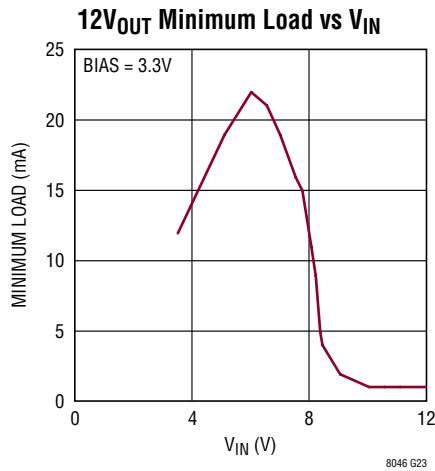
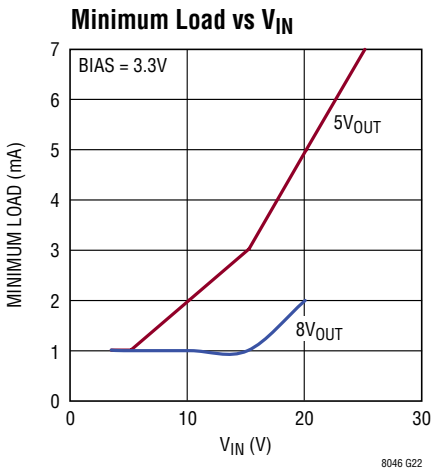
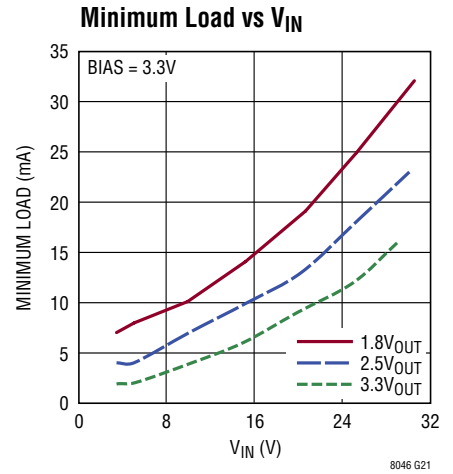
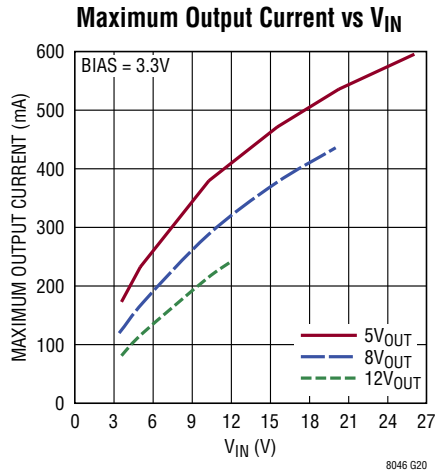
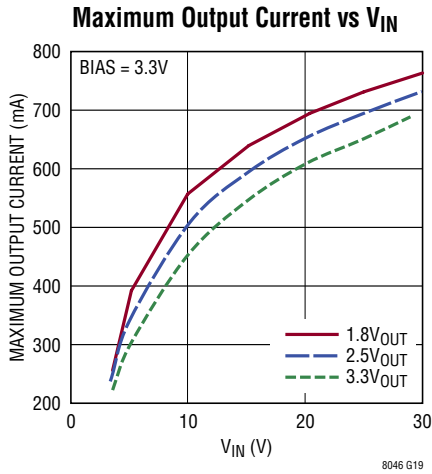

TYPICAL PERFORMANCE CHARACTERISTICS

Temperature Rise vs Output Current 5V_{OUT}

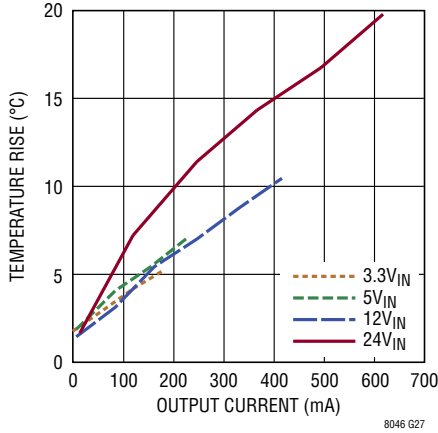

8046 G27

Temperature Rise vs Output Current 8V_{OUT}

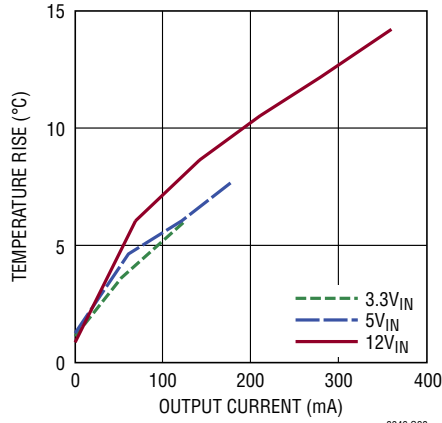

8046 G28

Temperature Rise vs Output Current 12V_{OUT}

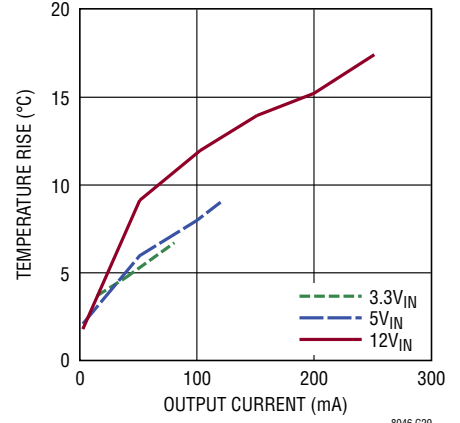

8046 G29

Output Ripple

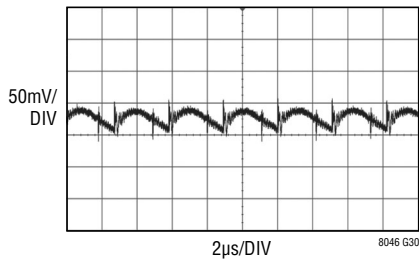

8046 G30

24V_{IN}, 5V_{OUT}
570mA LOAD
DC1559A DEMO BOARD
UNMODIFIED
150MHz BW

Step Input Start-Up Waveform

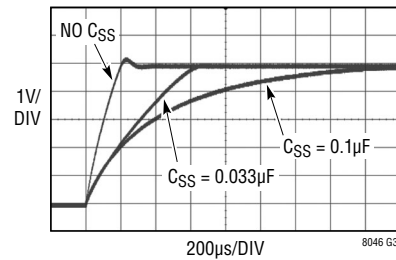

8046 G31

24V_{IN}, 5V_{OUT}
20Ω RESISTIVE LOAD

PIN FUNCTIONS

V_{IN} (Bank 1): V_{IN} supplies current to the LTM8046's internal regulator and to the integrated power switch. These pins must be locally bypassed with an external, low ESR capacitor.

GND (Bank 2): This is the primary side local ground of the LTM8046 primary. In most applications, the bulk of the heat flow out of the LTM8046 is through the GND and V_{OUT}⁻ pads, so the printed circuit design has a large impact on the thermal performance of the part. See the PCB Layout and Thermal Considerations sections for more details.

V_{OUT}⁻ (Bank 3): V_{OUT}⁻ is the return for V_{OUT}. V_{OUT} and V_{OUT}⁻ comprise the isolated output of the LTM8046. In most applications, the bulk of the heat flow out of the LTM8046 is through the GND and V_{OUT}⁻ pads, so the printed circuit design has a large impact on the thermal performance of the part. See the PCB Layout and Thermal Considerations sections for more details. Apply an external capacitor between V_{OUT} and V_{OUT}⁻.

V_{OUT} (Bank 4): V_{OUT} and V_{OUT}⁻ comprise the isolated output of the LTM8046 flyback stage. Apply an external capacitor between V_{OUT} and V_{OUT}⁻. Do not allow V_{OUT}⁻ to exceed V_{OUT}.

RUN (Pin L3): A resistive divider connected to V_{IN} and this pin programs the minimum voltage at which the LTM8046 will operate. Below 1.24V, the LTM8046 does not deliver

power to the secondary. Above 1.24V, power will be delivered to the secondary and 8μA will be fed into the SS pin. When RUN is less than 1.24V, the pin draws 2.5μA, allowing for a programmable hysteresis. Do not allow a negative voltage (relative to GND) on this pin.

BIAS (Pin L4): This pin supplies the power necessary to operate the LTM8046. It must be locally bypassed with a low ESR capacitor of at least 1μF. Do not allow this pin voltage to rise above V_{IN}.

SS (Pin L5): Place a soft-start capacitor here to limit inrush current and the output voltage ramp rate. Do not allow a negative voltage (relative to GND) on this pin.

FB (Pin L6): Apply a resistor from this pin to GND to set the output voltage, using the recommended value given in Table 1. If Table 1 does not list the desired V_{OUT} value, the equation

$$R_{FB} = 31.6(V_{OUT}^{-0.84})k\Omega$$

may be used to approximate the value. To the seasoned designer, this exponential equation may seem unusual. The equation is exponential due to non-linear current sources that are used to temperature compensate the output regulation.

BLOCK DIAGRAM

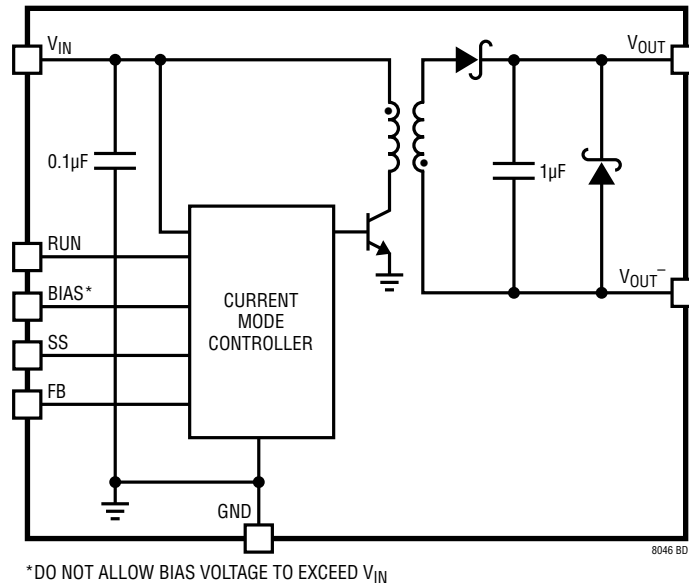

OPERATION

The LTM8046 is a stand-alone isolated flyback switching DC/DC μ Module converter that can deliver over 700mA of output current. This module provides a regulated output voltage programmable via one external resistor from 1.8V to 12V. The input voltage range of the LTM8046 is 3.1V to 31V. Given that the LTM8046 is a flyback converter, the output current depends upon the input and output voltages, so make sure that the input voltage is high enough to support the desired output voltage and load current. The Typical Performance Characteristics section gives several graphs of the maximum load versus V_{IN} for several output voltages.

A simplified block diagram is given. The LTM8046 contains a current mode controller, power switching element, power transformer, power Schottky diode, a modest amount of input and output capacitance.

The LTM8046 has a galvanic primary to secondary isolation rating of 2kVAC. This is verified by applying 3kVDC between the primary to secondary for 1 second. Note

that the 2kVAC isolation is verified by a 3kVDC test. This is because the 2kVAC waveform has a peak voltage 1.414 times higher than 2kV, or 2.83kVDC. For the LTM8046, at least 3kVDC is applied. For further details please refer to the Isolation and Working Voltage section.

An internal regulator provides power to the control circuitry. The bias regulator normally draws power from the V_{IN} pin, but if the BIAS pin is connected to an external voltage higher than 3.1V, bias power will be drawn from the external source, improving efficiency. V_{BIAS} must not exceed V_{IN} . The RUN pin is used to turn on or off the LTM8046, disconnecting the output and reducing the input current to 1 μ A or less.

The LTM8046 is a variable frequency device. For a fixed input and output voltage, the frequency decreases as the load increases. For light loads, the current through the internal transformer may be discontinuous, so that frequency may appear to decrease. Note that a minimum load is required to keep the output voltage in regulation. Refer to the Typical Performance Characteristics section.

APPLICATIONS INFORMATION

For most applications, the design process is straightforward, summarized as follows:

1. Look at Table 1 and find the row that has the desired input range and output voltage.
2. Apply the recommended C_{IN} , C_{OUT} and R_{FB} .
3. Connect BIAS as indicated, or tie to an external source up to 15V or V_{IN} , whichever is less.

While these component combinations have been tested for proper operation, it is incumbent upon the user to verify proper operation over the intended system's line, load and environmental conditions. Bear in mind that the maximum output current may be limited by junction temperature, the relationship between the input and output voltage magnitude and polarity and other factors. Please refer to the graphs in the Typical Performance Characteristics section for guidance.

Capacitor Selection Considerations

The C_{IN} and C_{OUT} capacitor values in Table 1 are the minimum recommended values for the associated operating conditions. Applying capacitor values below those indicated in Table 1 is not recommended, and may result

in undesirable operation. Using larger values is generally acceptable, and can yield improved dynamic response, if it is necessary. Again, it is incumbent upon the user to verify proper operation over the intended system's line, load and environmental conditions.

Ceramic capacitors are small, robust and have very low ESR. However, not all ceramic capacitors are suitable. X5R and X7R types are stable over temperature and applied voltage and give dependable service. Other types, including Y5V and Z5U have very large temperature and voltage coefficients of capacitance. In an application circuit they may have only a small fraction of their nominal capacitance resulting in much higher output voltage ripple than expected.

A final precaution regarding ceramic capacitors concerns the maximum input voltage rating of the LTM8046. A ceramic input capacitor combined with trace or cable inductance forms a high-Q (underdamped) tank circuit. If the LTM8046 circuit is plugged into a live supply, the input voltage can ring to much higher than its nominal value, possibly exceeding the device's rating. This situation is easily avoided; see the Hot-Plugging Safely section.

Table 1. Recommended Components and Configuration ($T_A = 25^\circ\text{C}$)

V_{IN}	V_{OUT}	C_{IN}	C_{OUT}	R_{FB}
3.2V to 32V	1.8V	1 μ F, 50V, 0805 X5R	2 \times 100 μ F, 6.3V, 1206 X5R	18.7k
3.2V to 31V	2.5V	1 μ F, 50V, 0805 X5R	2 \times 100 μ F, 6.3V, 1206 X5R	14.7k
3.2V to 29V	3.3V	1 μ F, 50V, 0805 X5R	100 μ F, 6.3V, 1206 X5R	11.8k
3.2V to 26V	5V	1 μ F, 25V, 0603 X5R	100 μ F, 6.3V, 1206 X5R	8.45k
3.2V to 20V	8V	1 μ F, 25V, 0603 X5R	47 μ F, 10V, 1206 X5R	5.49k
3.2V to 12V	12V	1 μ F, 25V, 0603 X5R	2 \times 10 μ F, 16V, 1210 X5R	3.83k
3.2V to 25V	2.5V	1 μ F, 25V, 0603 X5R	2 \times 100 μ F, 6.3V, 1206 X5R	14.7k
3.2V to 25V	3.3V	1 μ F, 25V, 0603 X5R	100 μ F, 6.3V, 1206 X5R	11.8k

CBIAS = 1 μ F 10V 0402 X5R

BIAS = 3.3V for $V_{IN} \geq 3.3\text{V}$, V_{IN} for $V_{IN} < 3.3\text{V}$. If BIAS = V_{IN} , the minimum input voltage is 4.3V.

APPLICATIONS INFORMATION

BIAS Pin Considerations

The BIAS pin is the output of an internal linear regulator that powers the LTM8046's internal circuitry. It is set to 3V and must be decoupled with a low ESR capacitor of at least 1 μ F. The LTM8046 will run properly without applying a voltage to this pin, but will operate more efficiently and dissipate less power if a voltage greater than 3.1V is applied. At low V_{IN} , the LTM8046 will be able to deliver more output current if BIAS is 3.1V or greater. Up to 31V may be applied to this pin, but a high BIAS voltage will cause excessive power dissipation in the internal circuitry. For applications with an input voltage less than 15V, the BIAS pin is typically connected directly to the V_{IN} pin. For input voltages greater than 15V, it is preferred to leave the BIAS pin separate from the V_{IN} pin, either powered from a separate voltage source or left running from the internal regulator. This has the added advantage of keeping the physical size of the BIAS capacitor small. Do not allow BIAS to rise above V_{IN} .

Soft-Start

For many applications, it is necessary to minimize the inrush current at start-up. The built-in soft-start circuit significantly reduces the start-up current spike and output voltage overshoot by applying a capacitor from SS to GND. When the LTM8046 is enabled, whether from V_{IN} reaching a sufficiently high voltage or RUN being pulled high, the LTM8046 will source approximately 8 μ A out of the SS pin. As this current gradually charges the capacitor from SS to GND, the LTM8046 will correspondingly increase the power delivered to the output, allowing for a graceful turn-on ramp.

Isolation Working Voltage and Safety

The LTM8046 isolation is 100% hi-pot tested by tying all of the primary pins together, all of the secondary pins together and subjecting the two resultant circuits to a differential of 3kVDC for one second. This establishes the isolation voltage rating of the LTM8046 component.

The isolation rating of the LTM8046 is not the same as the working or operational voltage that the application will experience. This is subject to the application's power source, operating conditions, the industry where the end product is used and other factors that dictate design requirements such as the gap between copper planes, traces and component pins on the printed circuit board, as well as the type of connector that may be used. To maximize the allowable working voltage, the LTM8046 has three rows of solder balls removed to facilitate the printed circuit board design. The ball to ball pitch is 1.27mm, and the typical ball diameter is 0.78mm. Accounting for the missing row and the ball diameter, the printed circuit board may be designed for a metal-to-metal separation of up to 4.3mm. This may have to be reduced somewhat to allow for tolerances in solder mask or other printed circuit board design rules.

To reiterate, the manufacturer's isolation voltage rating and the required operational voltage are often different numbers. In the case of the LTM8046, the isolation voltage rating is established by 100% hi-pot testing. The working or operational voltage is a function of the end product and its system level specifications. The actual required operational voltage is often smaller than the manufacturer's isolation rating.

For those situations where information about the spacing of LTM8046 internal circuitry is required, the minimum metal to metal separation of the primary and secondary is 1.9mm. The LTM8046 is a UL recognized component under UL 60950-1, file number E464570. The UL 60950-1 insulation category of the LTM8046 transformer is Functional. Considering UL 60950-1 Table 2N and the gap distances stated above, 4.3mm external and 1.9mm internal, the LTM8046 may be operated with up to 400V working voltage in a pollution degree 2 environment. The actual working voltage, insulation category, pollution degree and other critical parameters for the specific end application depend upon the actual environmental, application and safety compliance requirements. It is therefore up to the user to perform a safety and compliance review to ensure that the LTM8046 is suitable for the intended application.

APPLICATIONS INFORMATION

V_{OUT} to V_{OUT}^- Reverse Voltage

The LTM8046 cannot tolerate a reverse voltage from V_{OUT} to V_{OUT}^- during operation. If V_{OUT}^- raises above V_{OUT} during operation, the LTM8046 may be damaged. To protect against this condition, a low forward drop power Schottky diode has been integrated into the LTM8046, anti-parallel to V_{OUT}/V_{OUT}^- . This can protect the output against many reverse voltage faults. Reverse voltage faults can be both steady state and transient. An example of a steady state voltage reversal is accidentally misconnecting a powered LTM8046 to a negative voltage source. An example of transient voltage reversals is a momentary connection to a negative voltage. It is also possible to achieve a V_{OUT} reversal if the load is short-circuited through a long cable. The inductance of the long cable forms an LC tank circuit with the V_{OUT} capacitance, which drives V_{OUT} negative. Avoid these conditions.

Minimum Load

The LTM8046 requires a minimum load in order to maintain regulation. If less than the minimum load is applied, the output voltage may rise beyond the intended value uncontrollably, possibly damaging the LTM8046 or the application system. Avoid this situation. The Typical Performance Characteristics section provides graphs of the minimum required load for several input and output conditions at room temperature.

The LTM8046 is designed to skip switching cycles, if necessary, to maintain regulation. While cycle skipping, the output ripple may be higher than when the LTM8046 is not skipping cycles. The user must validate the performance of the LTM8046 application over the appropriate temperature, line, load and other operating conditions.

PCB Layout

Most of the headaches associated with PCB layout have been alleviated or even eliminated by the high level of integration of the LTM8046. The LTM8046 is nevertheless a switching power supply, and care must be taken to minimize electrical noise to ensure proper operation. Even with the high level of integration, you may fail to achieve specified operation with a haphazard or poor layout. See

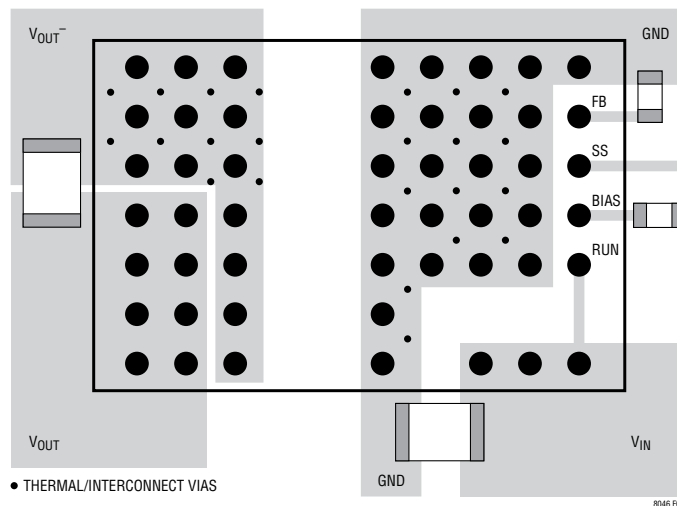

Figure 1. Layout Showing Suggested External Components, Planes and Thermal Vias

Figure 1 for a suggested layout. Ensure that the grounding and heat sinking are acceptable.

A few rules to keep in mind are:

1. Place the R_{ADJ} resistor as close as possible to its respective pin.
2. Place the C_{IN} capacitor as close as possible to the V_{IN} and GND connections of the LTM8046.
3. Place the C_{OUT} capacitor as close as possible to V_{OUT} and V_{OUT}^- .
4. Place the C_{IN} and C_{OUT} capacitors such that their ground current flow directly adjacent or underneath the LTM8046.
5. Connect all of the GND connections to as large a copper pour or plane area as possible on the top layer. Avoid breaking the ground connection between the external components and the LTM8046.
6. Use vias to connect the GND copper area to the board's internal ground planes. Liberally distribute these GND vias to provide both a good ground connection and thermal path to the internal planes of the printed circuit board. Pay attention to the location and density of the thermal vias in Figure 1. The LTM8046 can benefit from the heat sinking afforded by vias that connect to internal

APPLICATIONS INFORMATION

GND planes at these locations, due to their proximity to internal power handling components. The optimum number of thermal vias depends upon the printed circuit board design. For example, a board might use very small via holes. It should employ more thermal vias than a board that uses larger holes.

The printed circuit board construction has an impact on the isolation performance of the end product. For example, increased trace and layer spacing, as well as the choice of core and prepreg materials (such as using polyimide versus FR4) can significantly affect the isolation withstand of the end product.

Hot-Plugging Safely

The small size, robustness and low impedance of ceramic capacitors make them an attractive option for the input bypass capacitor of the LTM8046. However, these capacitors can cause problems if the LTM8046 is plugged into a live supply (see Linear Technology Application Note 88 for a complete discussion). The low loss ceramic capacitor combined with stray inductance in series with the power source forms an underdamped tank circuit, and the voltage at the V_{IN} pin of the LTM8046 can ring to more than twice the nominal input voltage, possibly exceeding the LTM8046's rating and damaging the part. If the input supply is poorly controlled or the user will be plugging the LTM8046 into an energized supply, the input network should be designed to prevent this overshoot. This can be accomplished by installing a small resistor in series to V_{IN} , but the most popular method of controlling input voltage overshoot is adding an electrolytic bulk capacitor to V_{IN} . This capacitor's relatively high equivalent series resistance damps the circuit and eliminates the voltage overshoot. The extra capacitor improves low frequency ripple filtering and can slightly improve the efficiency of the circuit, though it can be a large component in the circuit.

Thermal Considerations

The LTM8046 output current may need to be derated if it is required to operate in a high ambient temperature. The amount of current derating is dependent upon the input

voltage, output power and ambient temperature. The temperature rise curves given in the Typical Performance Characteristics section can be used as a guide. These curves were generated by the LTM8046 mounted to a 58cm² 4-layer FR4 printed circuit board. Boards of other sizes and layer count can exhibit different thermal behavior, so it is incumbent upon the user to verify proper operation over the intended system's line, load and environmental operating conditions.

For increased accuracy and fidelity to the actual application, many designers use FEA to predict thermal performance. To that end, the Pin Configuration section of the data sheet typically gives four thermal coefficients:

θ_{JA} : Thermal resistance from junction to ambient

$\theta_{JCbottom}$: Thermal resistance from junction to the bottom of the product case

θ_{JCtop} : Thermal resistance from junction to top of the product case

θ_{JB} : Thermal resistance from junction to the printed circuit board.

While the meaning of each of these coefficients may seem to be intuitive, JEDEC has defined each to avoid confusion and inconsistency. These definitions are given in JESD 51-12, and are quoted or paraphrased as follows:

θ_{JA} is the natural convection junction-to-ambient air thermal resistance measured in a one cubic foot sealed enclosure. This environment is sometimes referred to as still air although natural convection causes the air to move. This value is determined with the part mounted to a JESD 51-9 defined test board, which does not reflect an actual application or viable operating condition.

$\theta_{JCbottom}$ is the junction-to-board thermal resistance with all of the component power dissipation flowing through the bottom of the package. In the typical μ Module converter, the bulk of the heat flows out the bottom of the package, but there is always heat flow out into the ambient environment. As a result, this thermal resistance value may be useful for comparing packages but the test conditions don't generally match the user's application.

APPLICATIONS INFORMATION

θ_{JCtop} is determined with nearly all of the component power dissipation flowing through the top of the package. As the electrical connections of the typical μ Module converter are on the bottom of the package, it is rare for an application to operate such that most of the heat flows from the junction to the top of the part. As in the case of $\theta_{JCbottom}$, this value may be useful for comparing packages but the test conditions don't generally match the user's application.

θ_{JB} is the junction-to-board thermal resistance where almost all of the heat flows through the bottom of the μ Module converter and into the board, and is really the sum of the $\theta_{JCbottom}$ and the thermal resistance of the bottom of the part through the solder joints and through a portion of the board. The board temperature is measured a specified distance from the package, using a two-sided, two-layer board. This board is described in JESD 51-9.

Given these definitions, it should now be apparent that none of these thermal coefficients reflects an actual physical operating condition of a μ Module converter. Thus, none of them can be individually used to accurately predict the thermal performance of the product. Likewise, it would

be inappropriate to attempt to use any one coefficient to correlate to the junction temperature vs load graphs given in the product's data sheet. The only appropriate way to use the coefficients is when running a detailed thermal analysis, such as FEA, which considers all of the thermal resistances simultaneously.

A graphical representation of these thermal resistances is given in Figure 2.

The blue resistances are contained within the μ Module converter, and the green are outside.

The die temperature of the LTM8046 must be lower than the maximum rating of 125°C, so care should be taken in the layout of the circuit to ensure good heat sinking of the LTM8046. The bulk of the heat flow out of the LTM8046 is through the bottom of the module and the BGA pads into the printed circuit board. Consequently a poor printed circuit board design can cause excessive heating, resulting in impaired performance or reliability. Please refer to the PCB Layout section for printed circuit board design suggestions.

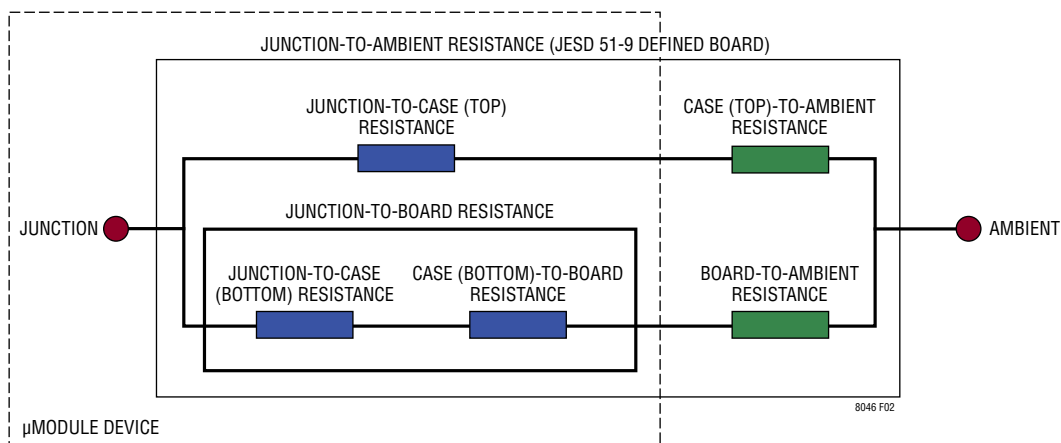
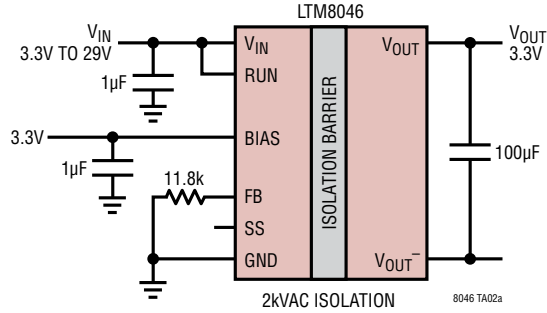

Figure 2.

TYPICAL APPLICATIONS

3.3V Isolated Flyback Converter



Maximum Output Current vs V_{IN}

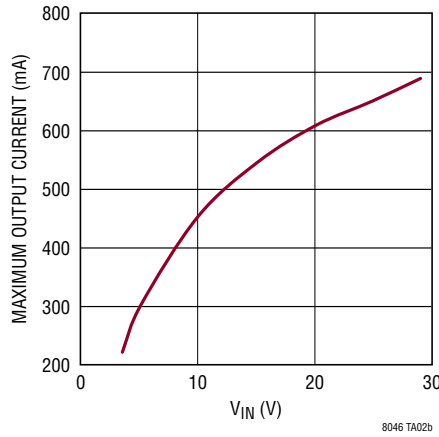

TYPICAL APPLICATIONS

Use Two LTM8046 Flyback Converters to Generate $\pm 5V$

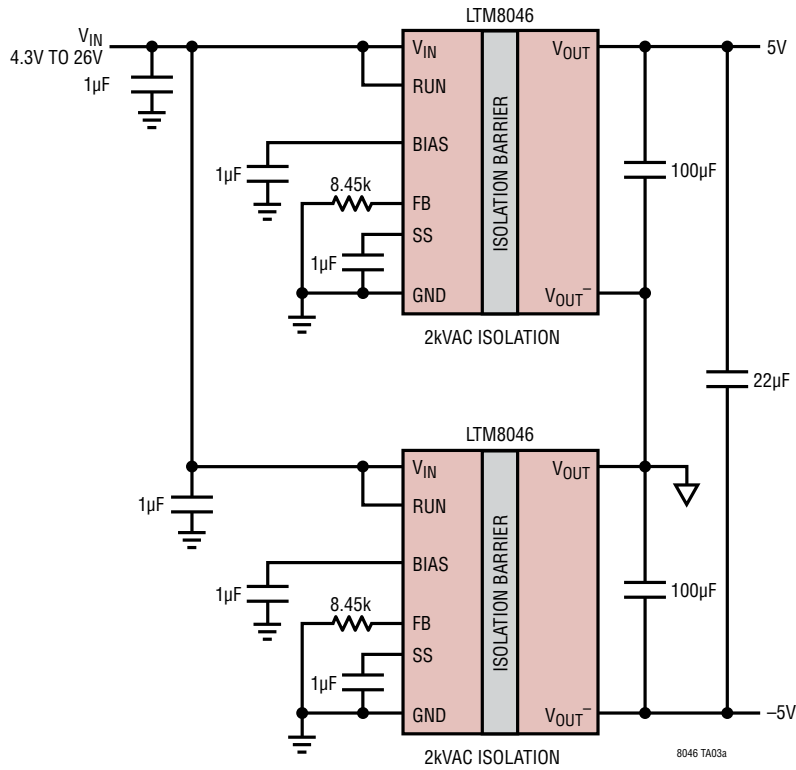

Maximum Output Current vs V_{IN}

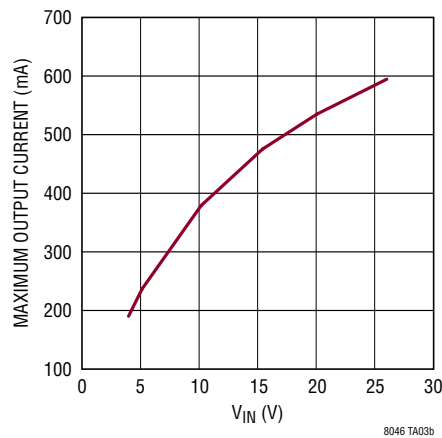

PACKAGE DESCRIPTION

Pin Assignment Table
(Arranged by Pin Number)

PIN NAME	PIN NAME	PIN NAME	PIN NAME	PIN NAME	PIN NAME	PIN NAME	PIN NAME	PIN NAME	PIN NAME	PIN NAME	PIN NAME
A1 V _{OUT}	B1 V _{OUT}	C1 V _{OUT} ⁻	D1 -	E1 -	F1 -	G1 GND	H1 -	J1 V _{IN}	K1 V _{IN}	L1 V _{IN}	
A2 V _{OUT}	B2 V _{OUT}	C2 V _{OUT} ⁻	D2 -	E2 -	F2 -	G2 GND	H2 -	J2 -	K2 -	L2 -	
A3 V _{OUT}	B3 V _{OUT}	C3 V _{OUT} ⁻	D3 -	E3 -	F3 -	G3 GND	H3 GND	J3 GND	K3 GND	L3 RUN	
A4 V _{OUT}	B4 V _{OUT}	C4 V _{OUT} ⁻	D4 -	E4 -	F4 -	G4 GND	H4 GND	J4 GND	K4 GND	L4 BIAS	
A5 V _{OUT} ⁻	B5 V _{OUT} ⁻	C5 V _{OUT} ⁻	D5 -	E5 -	F5 -	G5 GND	H5 GND	J5 GND	K5 GND	L5 SS	
A6 V _{OUT} ⁻	B6 V _{OUT} ⁻	C6 V _{OUT} ⁻	D6 -	E6 -	F6 -	G6 GND	H6 GND	J6 GND	K6 GND	L6 FB	
A7 V _{OUT} ⁻	B7 V _{OUT} ⁻	C7 V _{OUT} ⁻	D7 -	E7 -	F7 -	G7 GND	H7 GND	J7 GND	K7 GND	L7 GND	

PACKAGE PHOTO

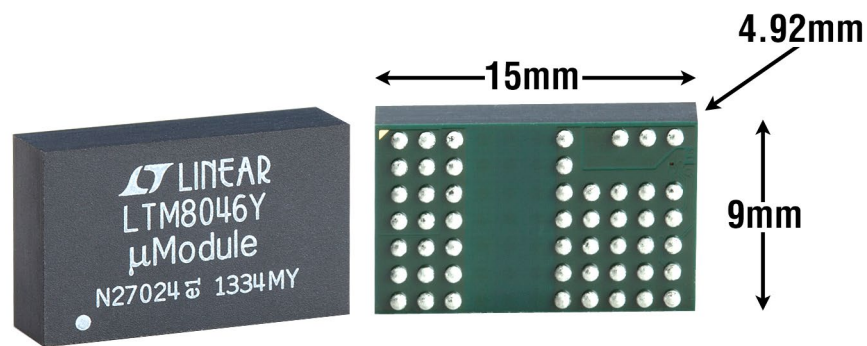

PACKAGE DESCRIPTION

Please refer to <http://www.linear.com/designtools/packaging/> for the most recent package drawings.

BGA Package 51-Lead (15.00mm × 9.00mm × 4.92mm) (Reference LTC DWG# 05-08-1889 Rev 0)

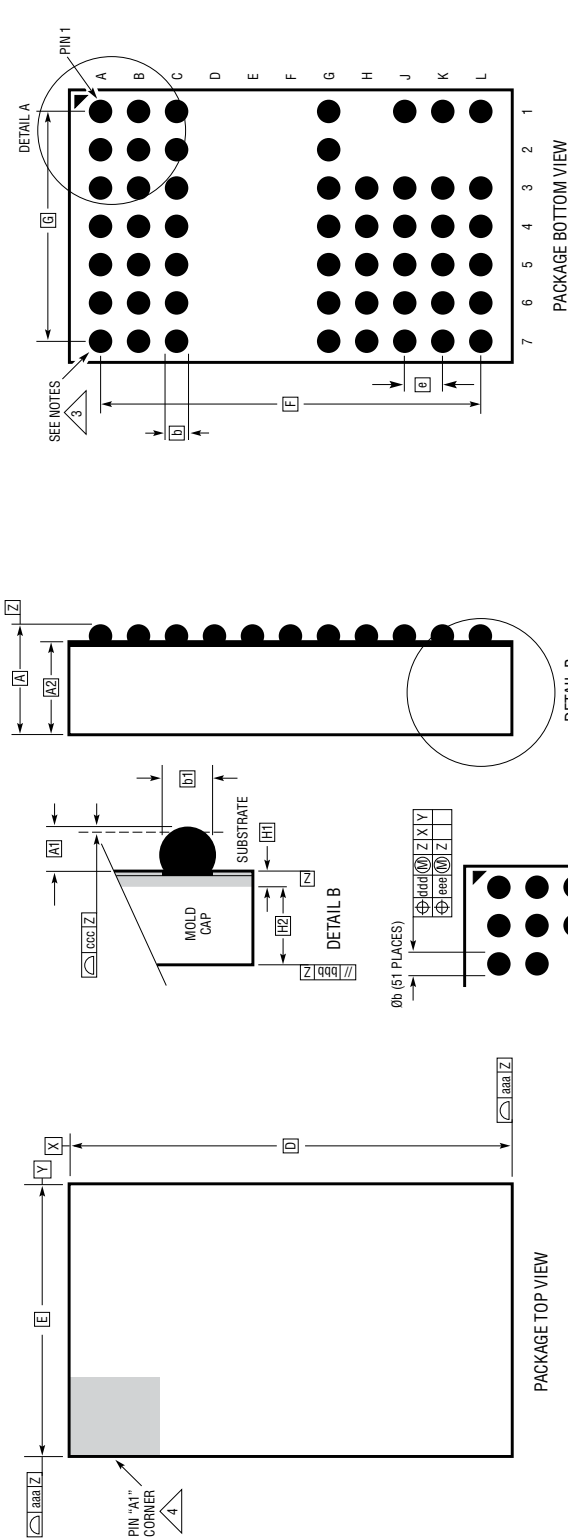

- NOTES:**
1. DIMENSIONING AND TOLERANCING PER ASME Y14.5M-1994
 2. ALL DIMENSIONS ARE IN MILLIMETERS
 3. BALL DESIGNATION PER JEDEC MS-028 AND JEP95
 4. DETAILS OF PIN #1 IDENTIFIER ARE OPTIONAL, BUT MUST BE LOCATED WITHIN THE ZONE INDICATED. THE PIN #1 IDENTIFIER MAY BE EITHER A MOLD OR MARKED FEATURE
 5. PRIMARY DATUM -Z- IS SEATING PLANE
 6. SOLDER BALL COMPOSITION CAN BE 96.5% Sn/3.0% Ag/0.5% Cu OR Sn/Pb EUTECTIC

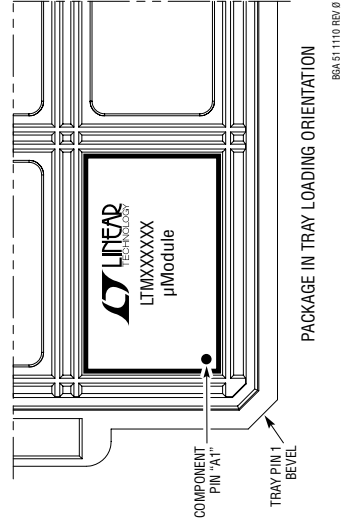

SYMBOL	DIMENSIONS		NOTES
	MIN	NOM	
A	4.72	4.92	5.12
A1	0.50	0.60	0.70
A2	4.22	4.32	4.42
b	0.71	0.78	0.85
b1	0.60	0.63	0.66
D	15.00		
E	9.00		
e	1.27		
F	12.70		
G	7.62		
H1	0.27	0.32	0.37
H2	3.95	4.00	4.05
aaa			0.15
bbb			0.10
ccc			0.20
ddd			0.30
eee			0.15
TOTAL NUMBER OF BALLS: 51			

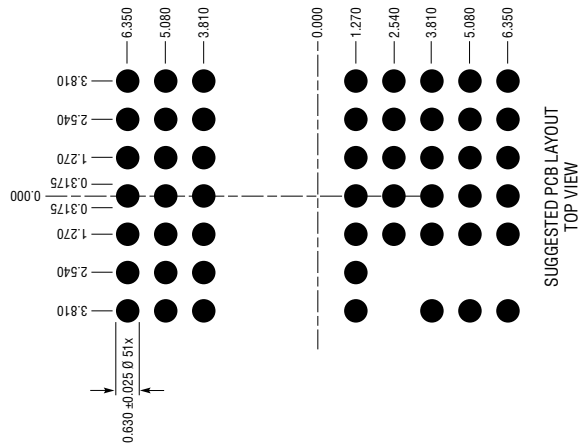

REVISION HISTORY

REV	DATE	DESCRIPTION	PAGE NUMBER
A	07/14	Add MP-grade	2, 3
B	04/15	V _{IN} changed from 32V to 31V	1

TYPICAL APPLICATION

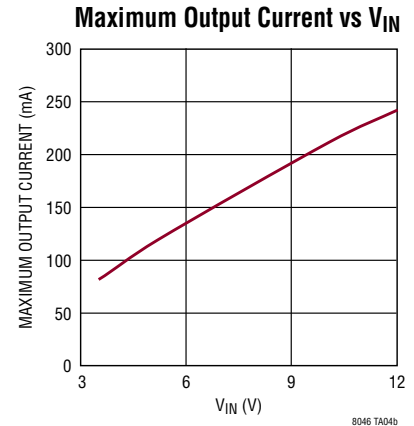
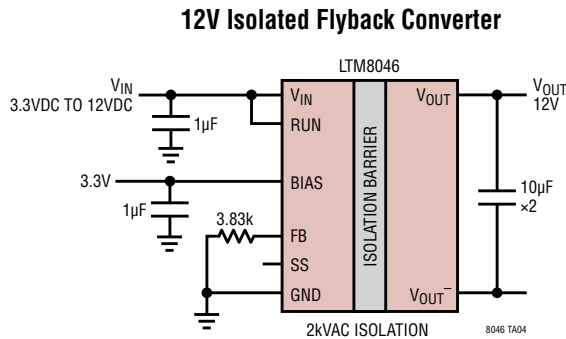

DESIGN RESOURCES

SUBJECT	DESCRIPTION
µModule Design and Manufacturing Resources	<p>Design:</p> <ul style="list-style-type: none"> • Selector Guides • Demo Boards and Gerber Files • Free Simulation Tools <p>Manufacturing:</p> <ul style="list-style-type: none"> • Quick Start Guide • PCB Design, Assembly and Manufacturing Guidelines • Package and Board Level Reliability
µModule Regulator Products Search	<ol style="list-style-type: none"> 1. Sort table of products by parameters and download the result as a spread sheet. 2. Search using the Quick Power Search parametric table. <div style="border: 1px solid #ccc; padding: 5px; margin: 5px 0;"> <p>Quick Power Search</p> <p>Input V_{in} (Min) <input type="text"/> V V_{in} (Max) <input type="text"/> V</p> <p>Output V_{out} <input type="text"/> V I_{out} <input type="text"/> A</p> <p style="text-align: right;"><input type="button" value="Search"/></p> </div>
TechClip Videos	Quick videos detailing how to bench test electrical and thermal performance of µModule products.
Digital Power System Management	Linear Technology's family of digital power supply management ICs are highly integrated solutions that offer essential functions, including power supply monitoring, supervision, margining and sequencing, and feature EEPROM for storing user configurations and fault logging.

RELATED PARTS

PART NUMBER	DESCRIPTION	COMMENTS
LTM8057	UL60950 Recognized 1.5W, 2kVAC Isolated µModule Converter	$3.1V \leq V_{IN} \leq 31V$, $2.5V \leq V_{OUT} \leq 12V$, 5% V_{OUT} Accuracy, Internal Isolated Transformer, 9mm × 11.25mm × 4.92mm BGA
LTM8058	UL60950 Recognized 1.5W, 2kVAC Isolated µModule Converter with LDO Post Regulator	$3.1V \leq V_{IN} \leq 31V$, $1.2V \leq V_{OUT} \leq 12V$, 2.5% V_{OUT} Accuracy, 1mV _{P-P} Output Ripple, Internal Isolated Transformer, 9mm × 11.25mm × 4.92mm BGA
LTM8048	1.5W, 725VDC Galvanically Isolated µModule Converter with LDO Post Regulator	$3.1V \leq V_{IN} \leq 32V$, $1.2V \leq V_{OUT} \leq 12V$, 2.5% V_{OUT} Accuracy, 1mV _{P-P} Output Ripple, Internal Isolated Transformer, 9mm × 11.25mm × 4.92mm BGA
LTM8045	Inverting or SEPIC µModule DC/DC Converter with Up to 700mA Output Current	$2.8V \leq V_{IN} \leq 18V$, $\pm 2.5V \leq V_{OUT} \leq \pm 15V$, Synchronizable, No Derating or Logic Level Shift for Control Inputs When Inverting, 6.25mm × 11.25mm × 4.92mm BGA
LTM4609	36V _{IN} , 5A DC/DC µModule Buck-Boost Regulator	$4.5V \leq V_{IN} \leq 36V$, $0.8V \leq V_{OUT} \leq 34V$, Adjustable Soft-Start, Clock Input, 15mm × 15mm × 2.82mm LGA and 15mm × 15mm × 3.42mm BGA
LTM8061	32V, 2A Step-Down µModule Battery Charger with Programmable Input Current Limit	Suitable for Charging Single and Dual Cell Li-Ion or Li-Poly Batteries, $4.95V \leq V_{IN} \leq 32V$, C/10 or Adjustable Timer Charge Termination, NTC Resistor Monitor Input, 9mm × 15mm × 4.32mm LGA

Looking for pricing, stock, or lifecycle information?

Click below to explore more details on WIN SOURCE:

 [View LTM8046IY#PBF on WIN SOURCE](#)

 [Linear Technology](#) Information

Optimize Your Supply Chain with WIN SOURCE Solutions

-  Global Sourcing Solution
-  Obsolete Management
-  Cost Control Management
-  Shortage Management
-  Alternative Solution
-  Excess Inventory Management