



**THE DATASHEET OF
MAX1154BEUE+**





Stand-Alone, 10-Channel, 10-Bit System Monitors with Internal Temperature Sensor and VDD Monitor

MAX1153/MAX1154

General Description

The MAX1153/MAX1154 are stand-alone, 10-channel (8 external, 2 internal) 10-bit system monitor ADCs with internal reference. A programmable single-ended/differential mux accepts voltage and remote-diode temperature-sensor inputs. These devices independently monitor the input channels without microprocessor interaction and generate an interrupt when any variable exceeds user-defined limits. The MAX1153/MAX1154 configure both high and low limits, as well as the number of fault cycles allowed, before generating an interrupt. These ADCs can also perform recursive data averaging for noise reduction. Programmable wait intervals between conversion sequences allow the selection of the sample rate.

At the maximum sampling rate of 94ksps (auto mode, single channel enabled), the MAX1153 consumes only 5mW (1.7mA at 3V). AutoShutdown™ reduces supply current to 190µA at 2ksps and to less than 8µA at 50sps.

Stand-alone operation, combined with ease of use in a small package (16-pin TSSOP), makes the MAX1153/MAX1154 ideal for multichannel system-monitoring applications. Low power consumption also makes these devices a good fit for hand-held and battery-powered applications.

Applications

System Supervision
Remote Telecom Networks
Server Farms
Remote Data Loggers

Selector Guide

PART	INL (LSB)	TEMP ERROR (°C)	SUPPLY VOLTAGE (V)
MAX1153BEUE+	±0.5	±3.0	2.7 to 3.6
MAX1154BEUE+	±0.5	±2.5	4.5 to 5.5

Typical Application Circuit appears at end of data sheet.

AutoShutdown is a trademark of Maxim Integrated Products, Inc.



For pricing, delivery, and ordering information, please contact Maxim Direct at 1-888-629-4642, or visit Maxim's website at www.maxim-ic.com.

Features

- ◆ Monitor 10 Signals Without Processor Intervention
- ◆ Eight External Channels Programmable as Temperature or Voltage Monitors
- ◆ Intelligent Circuitry for Reliable Autonomous Measurement
 - Programmable Digital Averaging Filter
 - Programmable Fault Counter
- ◆ Precision Measurements
 - 10-Bit Resolution
 - ±0.5 LSB INL, ±0.5 LSB DNL
 - ±0.75°C Temperature Accuracy (typ)
- ◆ Flexible
 - Automatic Channel Scan Sequencer with Programmable Intervals
 - Programmable Inputs: Single Ended/Differential, Voltage/Temperature
 - Programmable Wait State
- ◆ Internal 2.5V/4.096V Reference (MAX1153/MAX1154)
- ◆ Remote Temperature Sensing Up to 10m (Differential Mode)
- ◆ Single 3V or 5V Supply Operation
- ◆ Small 16-Pin TSSOP Package

Ordering Information

PART	TEMP RANGE	PIN-PACKAGE
MAX1153BEUE+	-40°C to +85°C	16 TSSOP
MAX1154BEUE+	-40°C to +85°C	16 TSSOP

+ Denotes a lead(Pb)-free/RoHS-compliant package.

Pin Configuration

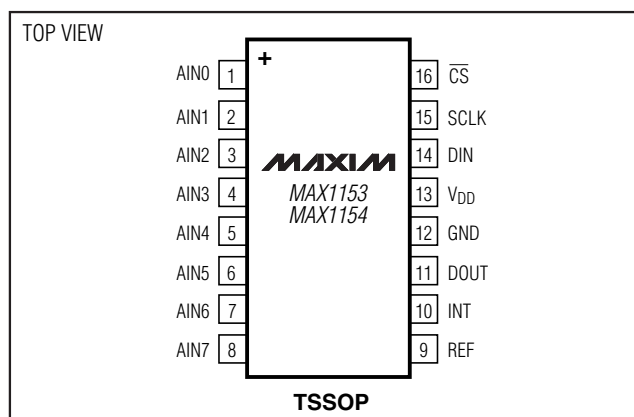

TSSOP

Stand-Alone, 10-Channel, 10-Bit System Monitors with Internal Temperature Sensor and VDD Monitor

ABSOLUTE MAXIMUM RATINGS

V_{DD} to GND-0.3V to +6V
 Analog Inputs to GND (AIN0–AIN7, REF) ... -0.3V to (V_{DD} + 0.3V)
 Digital Inputs to GND (DIN, SCLK, CS) -0.3V to (V_{DD} + 0.3V)
 Digital Outputs to GND (DOUT, INT) -0.3V to (V_{DD} + 0.3V)
 Digital Outputs Sink Current 25mA
 Maximum Current into Any Pin 50mA
 Continuous Power Dissipation (T_A = +70°C)
 16-Pin TSSOP (derate 11.1mW/°C above +70°C)889mW

Operating Temperature Range-40°C to +85°C
 Junction Temperature+150°C
 Storage Temperature Range-65°C to +150°C
 Lead Temperature (soldering, 10s)+300°C
 Soldering Temperature (reflow)+260°C

Stresses beyond those listed under "Absolute Maximum Ratings" may cause permanent damage to the device. These are stress ratings only, and functional operation of the device at these or any other conditions beyond those indicated in the operational sections of the specifications is not implied. Exposure to absolute maximum rating conditions for extended periods may affect device reliability.

ELECTRICAL CHARACTERISTICS

(V_{DD} = +2.7V to +3.6V (MAX1153), V_{DD} = +4.5V to +5.5V (MAX1154), V_{REF} = +2.5V (MAX1153), V_{REF} = +4.096V (MAX1154), f_{SCLK} = 10MHz (50% duty cycle), T_A = T_{MIN} to T_{MAX}, unless otherwise noted. Typical values are at T_A = +25°C.) (Note 1)

PARAMETER	SYMBOL	CONDITIONS	MIN	TYP	MAX	UNITS
DC ACCURACY						
Resolution	RES		10			Bits
Integral Nonlinearity (Note 2)	INL				±0.5	LSB
Differential Nonlinearity	DNL	No missing codes overtemperature			±0.5	LSB
Offset Error					±1.0	LSB
Gain Error (Note 3)		External reference			±1.0	LSB
		Internal reference			2.0	%FSR
Offset Error Tempco				±5		ppm/°C
Gain and Temperature Coefficient		External reference		±2		ppm/°C
		Internal reference		±30		
Channel-to-Channel Offset Matching				±0.1		LSB
V _{DD} Monitor Accuracy		Internal reference			±2.5	%
DYNAMIC ACCURACY (10kHz sine-wave input, 2.5VP-P (MAX1153), 4.096VP-P (MAX1154), 64ksps, f _{SCLK} = 10MHz, bipolar input mode)						
Signal-to-Noise Plus Distortion	SINAD			70		dB
Total Harmonic Distortion	THD	Up to the 5th harmonic		-76		dB
Spurious-Free Dynamic Range	SFDR			72		dB
Full-Power Bandwidth		-3dB point		1		MHz
Full Linear Bandwidth		S / (N + D) > 68dB		100		kHz
CONVERSION RATE						
Conversion Time (Note 4)	t _{CONV}	Voltage measurement, all ref modes		10.6	11.7	μs
		Temp-sensor ref modes 01, 10		46	50.7	
		Temp-sensor ref mode 00		73	80	
Single-Channel Throughput		Manual trigger, voltage measurement	70			ksps
Power-Up Time	t _{PU}	Internal reference (Note 5)		40	45	μs
ANALOG INPUT (AIN0–AIN7)						
Input Voltage Range (Note 6)		Unipolar, single-ended, or differential inputs	0		V _{REF}	V
		Bipolar, differential inputs	-V _{REF} / 2		+V _{REF} / 2	

Stand-Alone, 10-Channel, 10-Bit System Monitors with Internal Temperature Sensor and VDD Monitor

ELECTRICAL CHARACTERISTICS (continued)

($V_{DD} = +2.7V$ to $+3.6V$ (MAX1153), $V_{DD} = +4.5V$ to $+5.5V$ (MAX1154), $V_{REF} = +2.5V$ (MAX1153), $V_{REF} = +4.096V$ (MAX1154), $f_{SCLK} = 10MHz$ (50% duty cycle), $T_A = T_{MIN}$ to T_{MAX} , unless otherwise noted. Typical values are at $T_A = +25^{\circ}C$.) (Note 1)

PARAMETER	SYMBOL	CONDITIONS	MIN	TYP	MAX	UNITS
Common-Mode Range		Differentially configured inputs	0		V_{DD}	V
Common-Mode Rejection		Differentially configured inputs, $V_{CM} = 0$ to V_{DD}		90		dB
Input Leakage Current		On-/off- leakage, $V_{IN} = 0$ or V_{DD}		± 0.1	± 1	μA
Input Capacitance		(Note 7)		18		pF
TEMPERATURE MEASUREMENTS						
Internal Sensor Measurement Error (Note 8)		MAX1153	$T_A = -40^{\circ}C$ to $+85^{\circ}C$	± 1.2	± 3.0	$^{\circ}C$
			$T_A = +25^{\circ}C$	± 0.7		
		MAX1154	$T_A = -40^{\circ}C$ to $+85^{\circ}C$	± 1.2	± 2.5	
			$T_A = +25^{\circ}C$	± 0.7		
External Sensor Measurement Error (Note 9)		Differential	$T_A = -40^{\circ}C$ to $+85^{\circ}C$	± 2		$^{\circ}C$
			$T_A = +25^{\circ}C$	± 1		
		Single ended	$T_A = -40^{\circ}C$ to $+85^{\circ}C$	± 5		
			$T_A = +25^{\circ}C$	± 2		
Temperature Measurement Noise		Differentially configured inputs and internal sensor		0.1		$^{\circ}C$
		Single-ended configured, external sensor		0.5		
Temperature Resolution				0.5		$^{\circ}C/LSB$
External Sensor Bias Current		Low		4		μA
		High		66		
Power-Supply Rejection	PSR	Differentially configured inputs and internal sensor		0.3		$^{\circ}C/V$
		Single-ended configured, external sensor		0.1		
INTERNAL REFERENCE						
REF Output Voltage	V_{REF}	MAX1153	2.456	2.500	2.544	V
		MAX1154	2.456	4.096	4.168	
REF Temperature Coefficient	TC_{REF}			30		ppm/ $^{\circ}C$
REF Output Resistance				7		k Ω
REF Output Noise		MAX1153		200		μV_{RMS}
		MAX1154		160		dB
REF Power-Supply Rejection		MAX1153		-70	-50	V
		MAX1154		-70	-50	μA
EXTERNAL REFERENCE						
REF Input Voltage Range	V_{REF}		1.0	$V_{DD} + 0.05$		V
REF Input Current	I_{REF}	$V_{REF} = +2.5V$; $f_{SAMPLE} = 94ksp/s$		15	40	μA
		$V_{REF} = +2.5V$; $f_{SAMPLE} = 0ksp/s$			± 1	

Stand-Alone, 10-Channel, 10-Bit System Monitors with Internal Temperature Sensor and VDD Monitor

ELECTRICAL CHARACTERISTICS (continued)

(V_{DD} = +2.7V to +3.6V (MAX1153), V_{DD} = +4.5V to +5.5V (MAX1154), V_{REF} = +2.5V (MAX1153), V_{REF} = +4.096V (MAX1154), f_{SCLK} = 10MHz (50% duty cycle), T_A = T_{MIN} to T_{MAX}, unless otherwise noted. Typical values are at T_A = +25°C.) (Note 1)

PARAMETER	SYMBOL	CONDITIONS	MIN	TYP	MAX	UNITS
DIGITAL INPUTS (SCLK, DIN, \overline{CS})						
Input Voltage Low	V _{IL}				V _{DD} × 0.3	V
Input Voltage High	V _{IH}		V _{DD} × 0.7			V
Input Hysteresis	V _{HYST}			200		mV
Input Leakage Current	I _{IN}	V _{IN} = 0 or V _{DD}			±10	μA
Input Capacitance	C _{IN}			2		pF
DIGITAL OUTPUTS (INT, DOUT)						
Output Voltage Low	V _{OL}	I _{SINK} = 8mA, DOUT			0.5	V
		I _{SINK} = 2mA, INT			0.5	
Output Voltage High	V _{OH}	I _{SOURCE} = 8mA, DOUT	V _{DD} - 0.5			V
		I _{SOURCE} = 2mA, INT	V _{DD} - 0.5			
Tri-State Leakage Current	I _L	\overline{CS} = V _{DD}			±10	μA
Tri-State Output Capacitance	C _{OUT}	\overline{CS} = V _{DD}		5		pF
POWER REQUIREMENTS						
Positive Supply Voltage	V _{DD}	MAX1153	2.7		3.6	V
		MAX1154	2.7		5.5	
Supply Current	I _{DD}	MAX1153 internal reference (Note 10)			3.3	mA
		MAX1153 internal reference (Note 11)			2.9	
		MAX1153 internal reference (Note 11)			2.2	
		MAX1154 internal reference (Note 10)			5.0	
		MAX1154 internal reference (Note 11)			4.0	
		MAX1154 internal reference (Note 11)			3.0	
		Both internal reference, mode 01 (Note 12)		8		μA
Full Power-Down Supply Current	I _{SHDN}	Full power-down state	MAX1153	480		nA
			MAX1154	860		
Power-Supply Rejection Ratio	PSRR	Analog inputs at full scale (Note 13)		±0.4	±1.6	μA

Stand-Alone, 10-Channel, 10-Bit System Monitors with Internal Temperature Sensor and VDD Monitor

TIMING CHARACTERISTICS

($V_{DD} = +2.7V$ to $+3.6V$ (MAX1153), $V_{DD} = +4.5V$ to $+5.5V$ (MAX1154), $T_A = T_{MIN}$ to T_{MAX} , unless otherwise noted.) (Note 1) (Figures 1, 2, and 4)

PARAMETER	SYMBOL	CONDITIONS	MIN	TYP	MAX	UNITS
SCLK Clock Period	t_{CP}		100			ns
SCLK Pulse Width High Time	t_{CH}		45			ns
SCLK Pulse Width Low Time	t_{CL}		45			ns
DIN to SCLK Setup Time	t_{DS}		25			ns
DIN to SCLK Hold Time	t_{DH}		0			ns
\overline{CS} Fall to SCLK Rise Setup	t_{CSS}		25			ns
SCLK Rise to \overline{CS} Rise Hold	t_{CSH}		50			ns
SCLK Fall to DOUT Valid	t_{DOV}	$C_L = 30pF$			50	ns
\overline{CS} Rise to DOUT Disable	t_{DOD}	$C_L = 30pF$			40	ns
\overline{CS} Fall to DOUT Enable	t_{DOE}	$C_L = 30pF$			40	ns
\overline{CS} Pulse Width High	t_{CSW}		50			ns

- Note 1:** The devices are 100% tested at $T_A = +25^\circ C$ and $+85^\circ C$. Specification over temperature range is guaranteed by design.
- Note 2:** Relative accuracy is the deviation of the analog value at any code from its theoretical value after the gain and offset errors have been calibrated.
- Note 3:** Offset nulled.
- Note 4:** In reference mode 00, the reference system powers up for each temperature measurement. In reference mode 01, the reference system powers up once per sequence of channels scanned. If a sample wait $<80\mu s$ is programmed, the reference system is on all the time. In reference mode 10, the reference system is on all the time (see Table 7).
- Note 5:** No external capacitor on REF.
- Note 6:** The operational input voltage range for each individual input of a differentially configured pair (AIN0–AIN7) is from GND to V_{DD} . The operational input voltage difference is from $-V_{REF}/2$ to $+V_{REF}/2$.
- Note 7:** See Figure 3 and the Sampling Error vs. Input Source Impedance graph in the *Typical Operating Characteristics* section.
- Note 8:** Grade A tested at $+10^\circ C$ and $+55^\circ C$. $-20^\circ C$ to $+85^\circ C$ and $-40^\circ C$ to $+85^\circ C$ specifications guaranteed by design. Grade B tested at $+25^\circ C$. T_{MIN} to T_{MAX} specification guaranteed by design.
- Note 9:** External temperature measurement mode using an MMBT3904 (Diodes Inc.) as a sensor. External temperature sensing from $-40^\circ C$ to $+85^\circ C$; MAX1153/MAX1154 held at $+25^\circ C$.
- Note 10:** Performing eight single-ended external channels' temperature measurements, an internal temperature measurement, and an internal V_{DD} measurement with no sample wait results in a conversion rate of 2ksps per channel.
- Note 11:** Performing eight single-ended voltage measurements, an internal temperature measurement, and an internal V_{DD} measurement with no sample wait results in a conversion rate of 7ksps per channel.
- Note 12:** Performing eight single-ended voltage measurements, an internal temperature measurement, and an internal V_{DD} measurement with maximum sample wait results in a conversion rate of 3ksps per channel.
- Note 13:** Defined as the shift in the code boundary as a result of supply voltage change. $V_{DD} = \text{min to max}$; full-scale input, measured using external reference.

Stand-Alone, 10-Channel, 10-Bit System Monitors with Internal Temperature Sensor and VDD Monitor

Typical Operating Characteristics

($V_{DD} = +3V$, $V_{REF} = +2.5V$ (MAX1153); $V_{DD} = +5V$, $V_{REF} = +4.096V$ (MAX1154); $f_{SCLK} = 10MHz$, $C_{REF} = 0.1\mu F$, $T_A = +25^\circ C$, unless otherwise noted.)

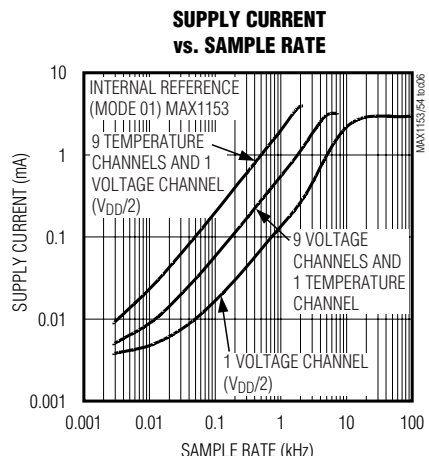
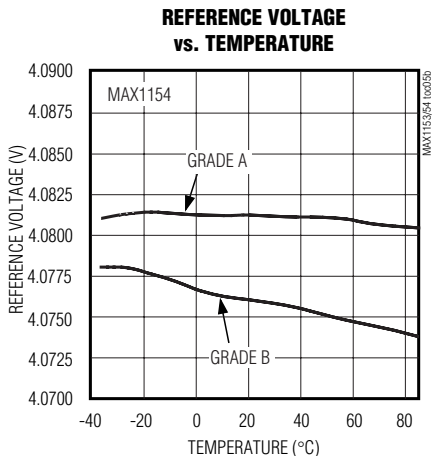
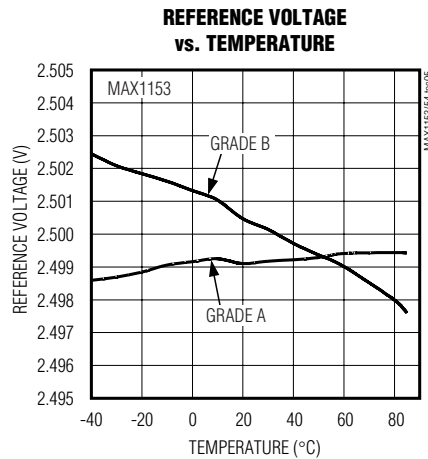
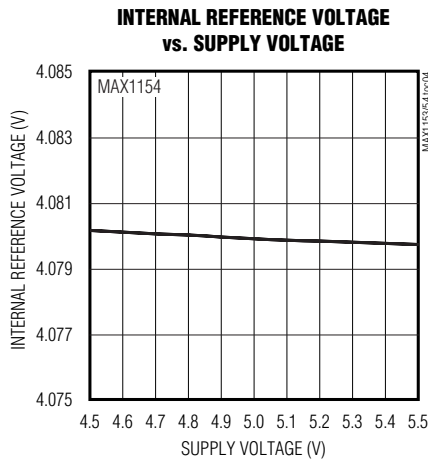
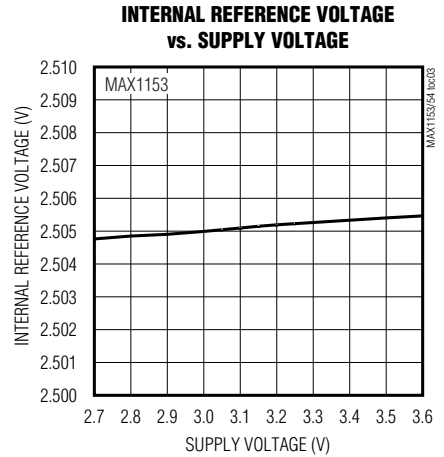
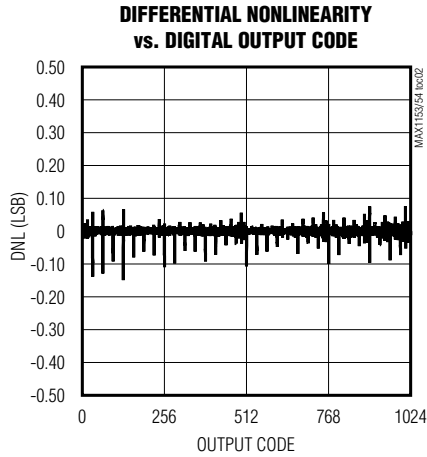
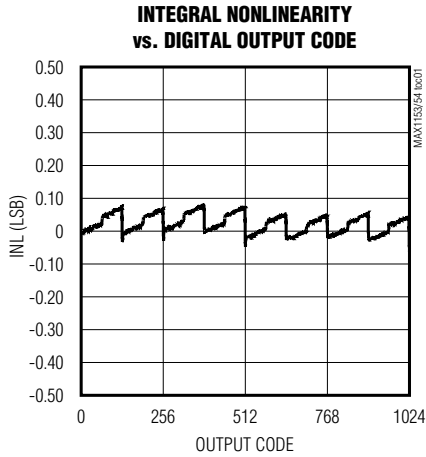

Stand-Alone, 10-Channel, 10-Bit System Monitors with Internal Temperature Sensor and VDD Monitor

Typical Operating Characteristics (continued)

($V_{DD} = +3V$, $V_{REF} = +2.5V$ (MAX1153); $V_{DD} = +5V$, $V_{REF} = +4.096V$ (MAX1154); $f_{SCLK} = 10MHz$, $C_{REF} = 0.1\mu F$, $T_A = +25^\circ C$, unless otherwise noted.)

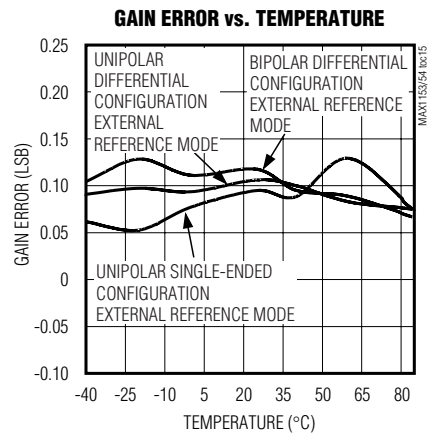
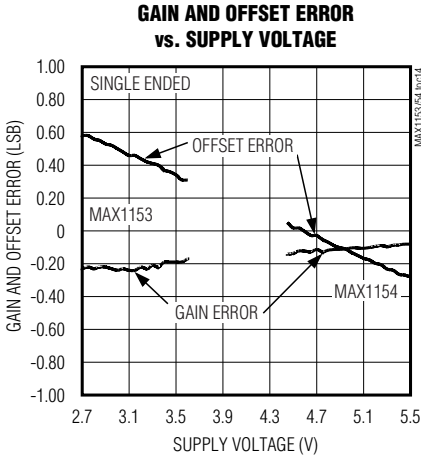
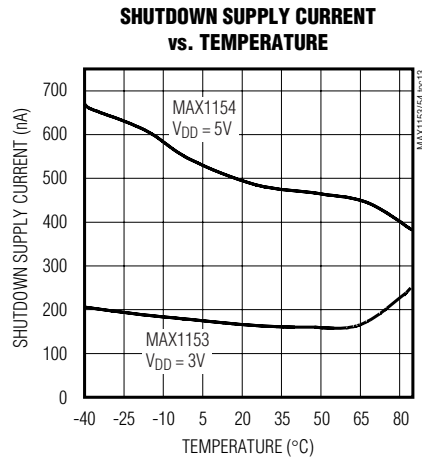
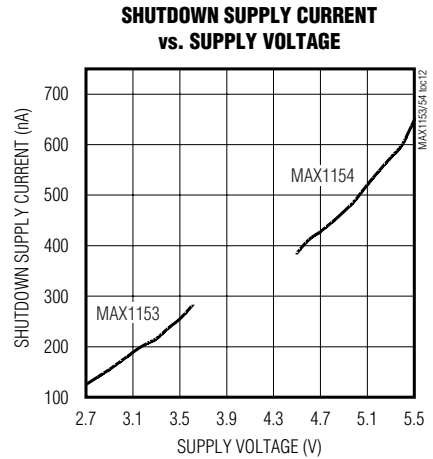
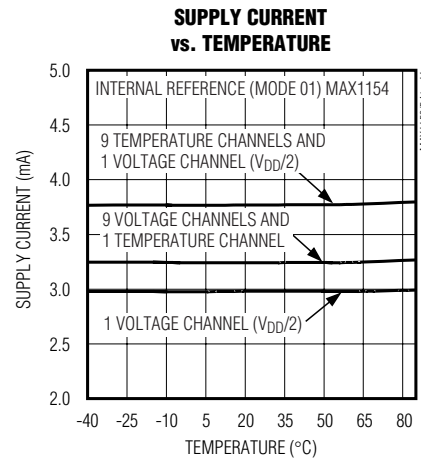
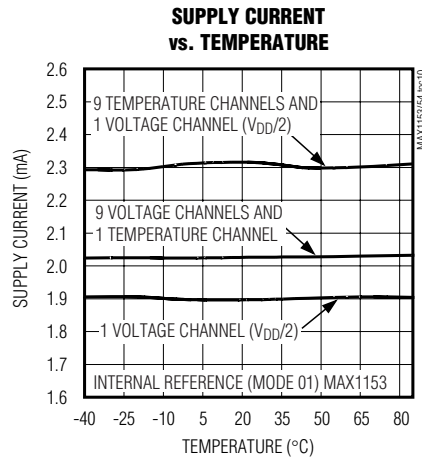
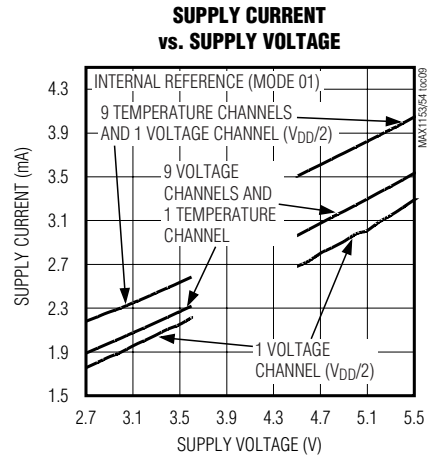
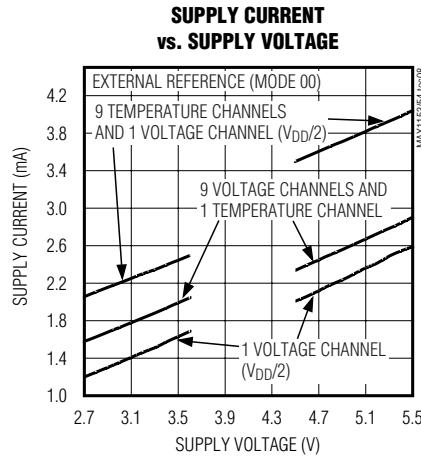
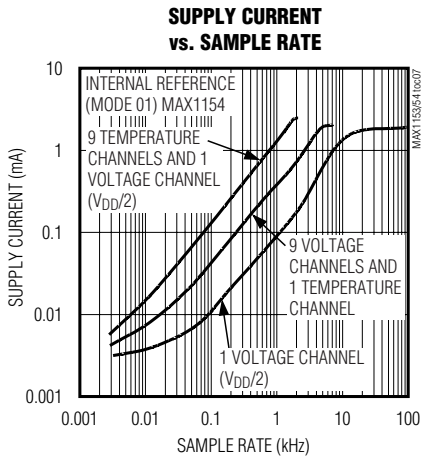

Stand-Alone, 10-Channel, 10-Bit System Monitors with Internal Temperature Sensor and VDD Monitor

Typical Operating Characteristics (continued)

($V_{DD} = +3V$, $V_{REF} = +2.5V$ (MAX1153); $V_{DD} = +5V$, $V_{REF} = +4.096V$ (MAX1154); $f_{SCLK} = 10MHz$, $C_{REF} = 0.1\mu F$, $T_A = +25^\circ C$, unless otherwise noted.)

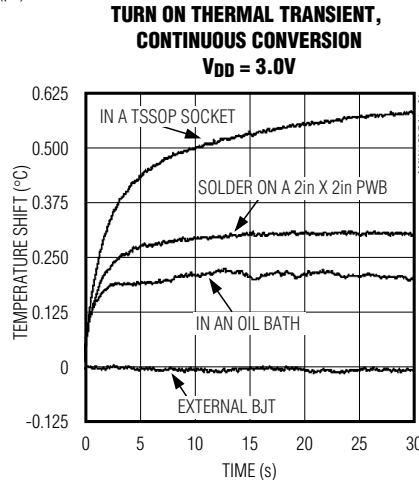
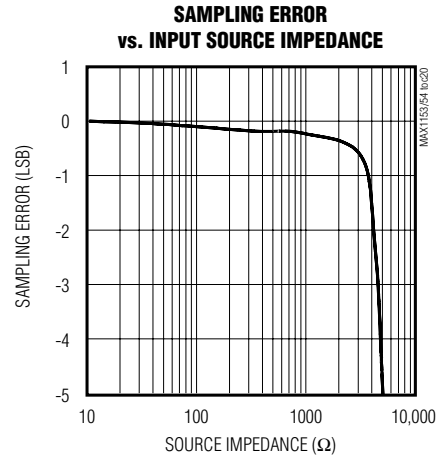
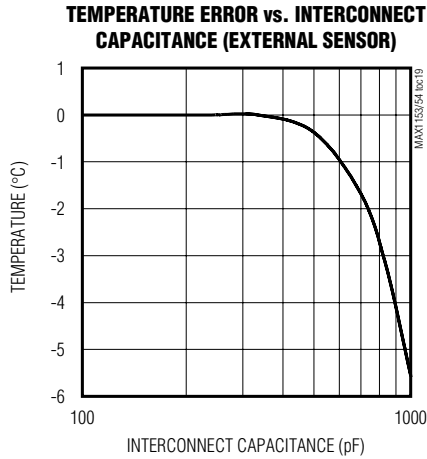
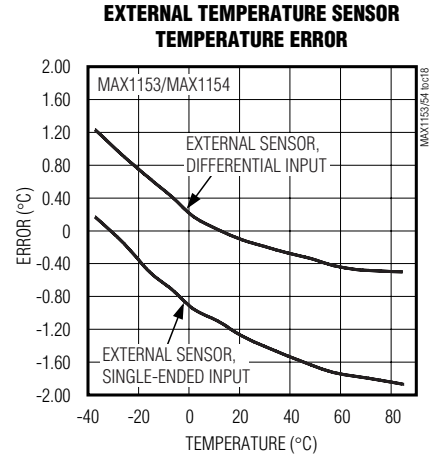
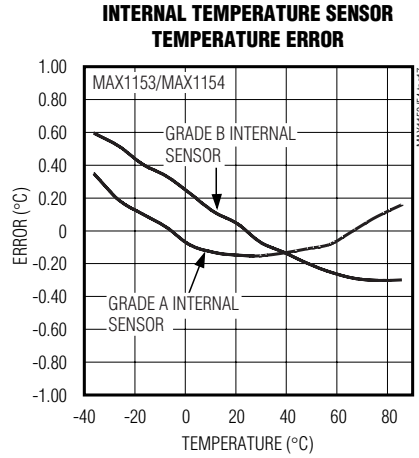
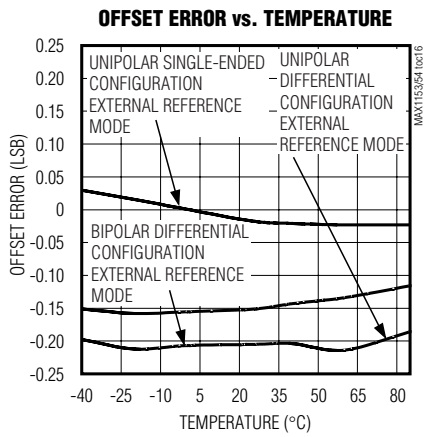

Stand-Alone, 10-Channel, 10-Bit System Monitors with Internal Temperature Sensor and VDD Monitor

Block Diagram

MAX1153/MAX1154

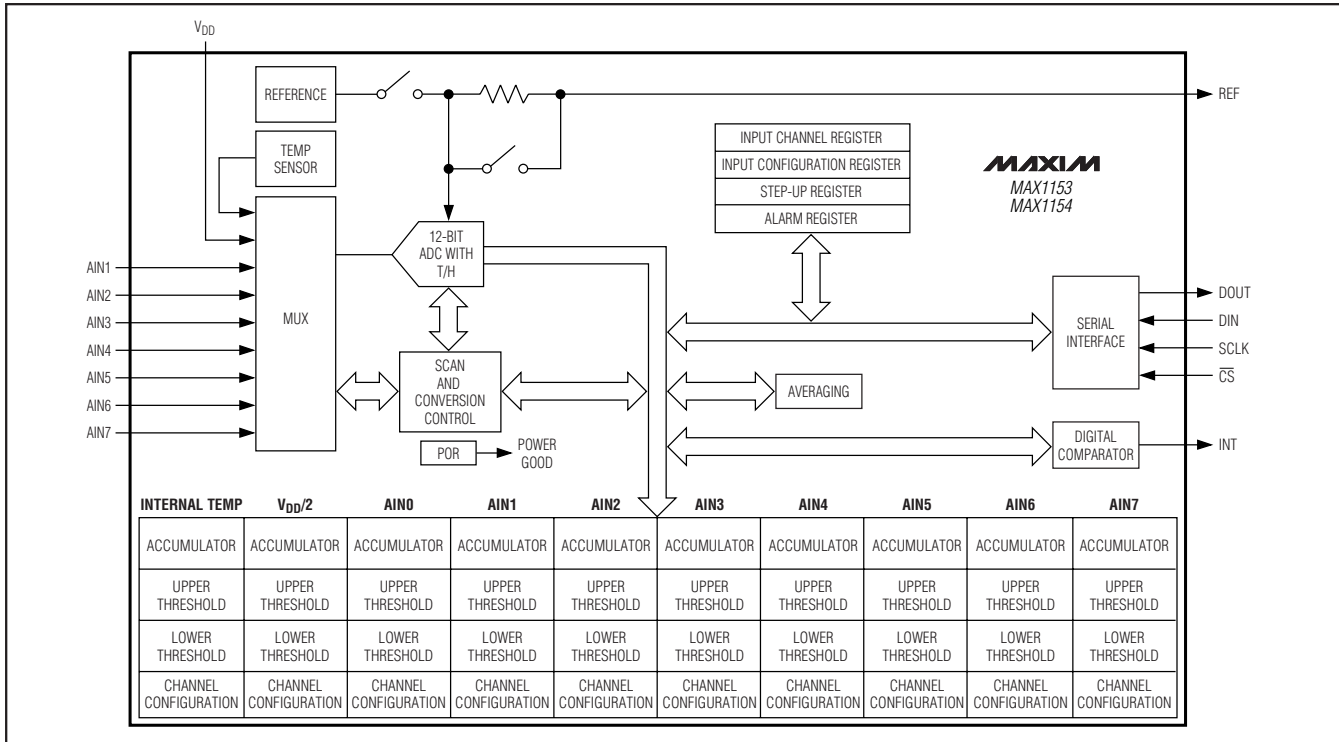

Pin Description

PIN	NAME	FUNCTION
1	AIN0	Analog Voltage Input/Temperature Input Channel 0 or Positive Differential Input Relative to AIN1
2	AIN1	Analog Voltage Input/Temperature Input Channel 1 or Negative Differential Input Relative to AIN0
3	AIN2	Analog Voltage Input/Temperature Input Channel 2 or Positive Differential Input Relative to AIN3
4	AIN3	Analog Voltage Input/Temperature Input Channel 3 or Negative Differential Input Relative to AIN2
5	AIN4	Analog Voltage Input/Temperature Input Channel 4 or Positive Differential Input Relative to AIN5
6	AIN5	Analog Voltage Input/Temperature Input Channel 5 or Negative Differential Input Relative to AIN4
7	AIN6	Analog Voltage Input/Temperature Input Channel 6 or Positive Differential Input Relative to AIN7
8	AIN7	Analog Voltage Input/Temperature Input Channel 7 or Negative Differential Input Relative to AIN6
9	REF	Positive Reference Input in External Mode. Bypass REF with a 0.1µF capacitor to GND when in external mode. When using the internal reference, REF must be left open.
10	INT	Interrupt Output. Push-pull or open drain with selectable polarity. See Table 9 and the <i>INT Interrupt Output</i> section.
11	DOUT	Serial Data Output. DOUT transitions on the falling edge of SCLK. High impedance when \overline{CS} is at logic high.
12	GND	Ground
13	V _{DD}	Positive Power Supply. Bypass V _{DD} with a 0.1µF capacitor to GND.
14	DIN	Serial Data Input. DIN data is latched into the serial interface on the rising edge of the SCLK.
15	SCLK	Serial Clock Input. SCLK clocks data in and out of the serial interface (duty cycle must be 40% to 60%).
16	\overline{CS}	Active-Low Chip-Select Input. When \overline{CS} is low, the serial interface is enabled. When \overline{CS} is high, DOUT is high impedance, and the serial interface resets.

Stand-Alone, 10-Channel, 10-Bit System Monitors with Internal Temperature Sensor and VDD Monitor

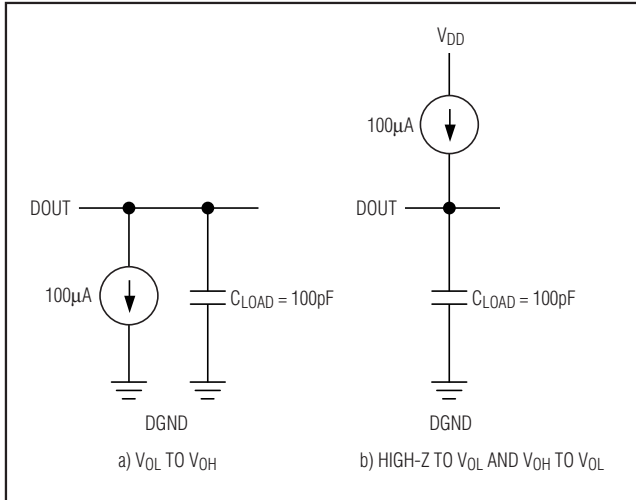

Figure 1. Load Circuits for DOUT Enable Time and SCLK to DOUT Delay Time

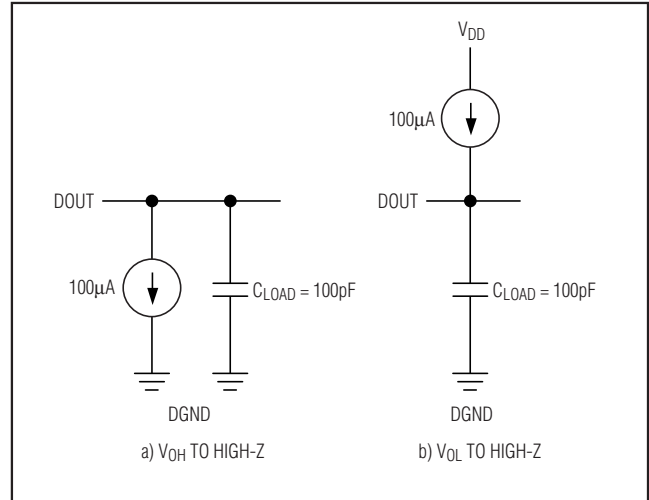

Figure 2. Load Circuit for DOUT Disable Time

Detailed Description

The MAX1153/MAX1154 are precision-monitoring integrated circuit systems specifically intended for stand-alone operation. They can monitor diverse types of inputs, such as those from temperature sensors and voltage signals from pressure, vibration, and acceleration sensors, and digitize these input signals. The digital values are then compared to preprogrammed thresholds and, if the thresholds are exceeded, the processor is alerted by an interrupt signal. No interaction by the CPU or microcontroller (μC) is required until one of the programmed limits is exceeded (Figures 3 and 4).

Voltages on all the inputs are converted to 10-bit values sequentially and stored in the current data registers. Note that eight of these inputs are external and two are internal. One of the internal inputs monitors the V_{DD} voltage supply, while the other monitors the internal IC temperature. AIN0 to AIN7 can be configured as either single ended (default) or differential. In addition, these inputs can be configured for single-ended or differential temperature measurements. In the temperature configuration, the device provides the proper bias necessary to measure temperature with a diode-connected transistor sensor. The user enables which inputs are measured (both external and internal) and sets the delay between each sequence of measurements during the initial setup of the device.

The values stored in the current data registers are compared to the user-preprogrammed values in the threshold registers (upper and lower thresholds) and, if exceeded, activate the interrupt output and generate an

alarm condition. If desired, the device can be programmed to average the results of many measurements before comparing to the threshold value. This reduces the sensitivity to external noise in the measured signal. In addition, the user can set the number of times the threshold is exceeded (fault cycles) before generating an interrupt. This feature reduces falsely triggered alarms caused by undesired, random spurious impulses.

When the fault cycle criterion is exceeded, an alarm condition is created. The device writes the fault condition into the alarm register to indicate the alarmed input channel.

Converter Operation

The MAX1153/MAX1154 ADCs use a fully differential successive-approximation register (SAR) conversion technique and an on-chip track-and-hold (T/H) block to convert temperature and voltage signals into a 10-bit digital result. Both single-ended and differential configurations are supported with a unipolar signal range for single-ended mode and bipolar or unipolar ranges for differential mode. Figure 5 shows the equivalent input circuit for the MAX1153/MAX1154. Configure the input channels according to Tables 5 and 6 (see the *Input Configuration Register* section).

In single-ended mode, the positive input (IN+) is connected to the selected input channel and the negative input (IN-) is connected to GND. In differential mode, IN+ and IN- are selected from the following pairs: AIN0/AIN1, AIN2/AIN3, AIN4/AIN5, and AIN6/AIN7. Once initiated, voltage conversions require 10.6 μs (typ) to complete.

Stand-Alone, 10-Channel, 10-Bit System Monitors with Internal Temperature Sensor and VDD Monitor

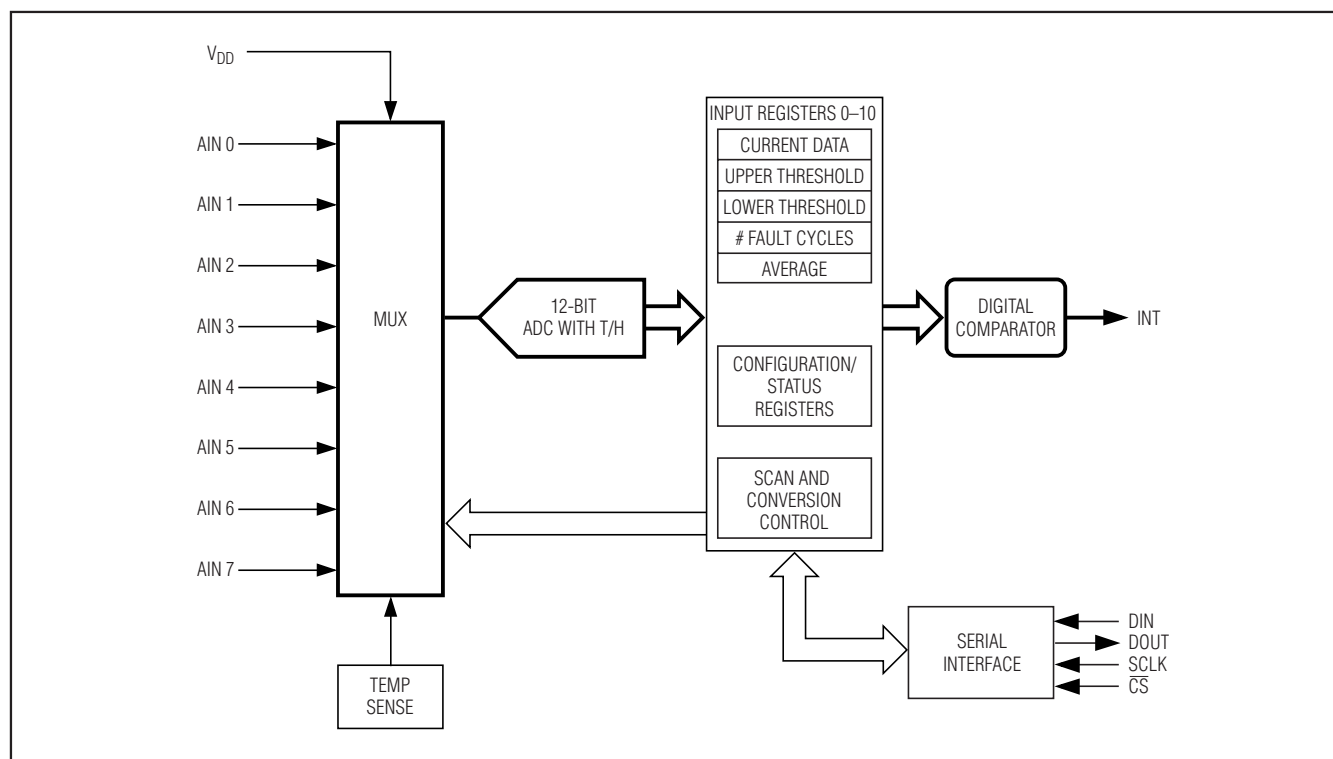

Figure 3. Simplified Alarm Block Diagram of the MAX1153/MAX1154

During the acquisition interval, IN+ and IN- charge both a positive (CHOLDP) and a negative (CHOLDN) sampling capacitor. After completing the acquisition interval, the T/H switches open, storing an accurate sample of the differential voltage between IN+ and IN-. This charge is then transferred to the ADC and converted. Finally, the conversion result is transferred to the current data register.

Temperature conversions require 46 μ s (typ) and measure the difference between two sequential voltage measurements (see the *Temperature Measurement* section for a detailed description).

Fully Differential Track/Hold (T/H)

The T/H acquisition interval begins with the rising edge of \overline{CS} (for manually triggered conversions) and is internally timed to 1.5 μ s (typ). The accuracy of the input signal sample is a function of the input signal's source impedance and the T/H's capacitance. In order to achieve adequate settling of the T/H, limit the signal source impedance to a maximum of 1k Ω .

Input Bandwidth

The ADC's input tracking circuitry has a 1MHz small-signal bandwidth. To avoid high-frequency signals aliasing into the frequency band of interest, anti-alias prefiltering of the input signals is recommended.

Analog Input Protection

Internal protection diodes, which clamp the analog inputs to V_{DD} and GND, allow the channel input pins to swing from (V_{GND} - 0.3V) to (V_{DD} + 0.3V) without damage. However, for accurate conversions near full scale, the inputs must not exceed V_{DD} by more than 50mV or be lower than V_{GND} by 50mV. If the analog input range must exceed 50mV beyond the supplies, limit the input current.

Single Ended/Differential

The MAX1153/MAX1154 use a fully differential ADC for all conversions. Through the input configuration register, the analog inputs can be configured for either differential or single-ended conversions. When sampling signal sources close to the MAX1153/MAX1154, single-ended conversion is generally sufficient. Single-ended conversions use only one analog input per signal source, internally referenced to GND.

Stand-Alone, 10-Channel, 10-Bit System Monitors with Internal Temperature Sensor and VDD Monitor

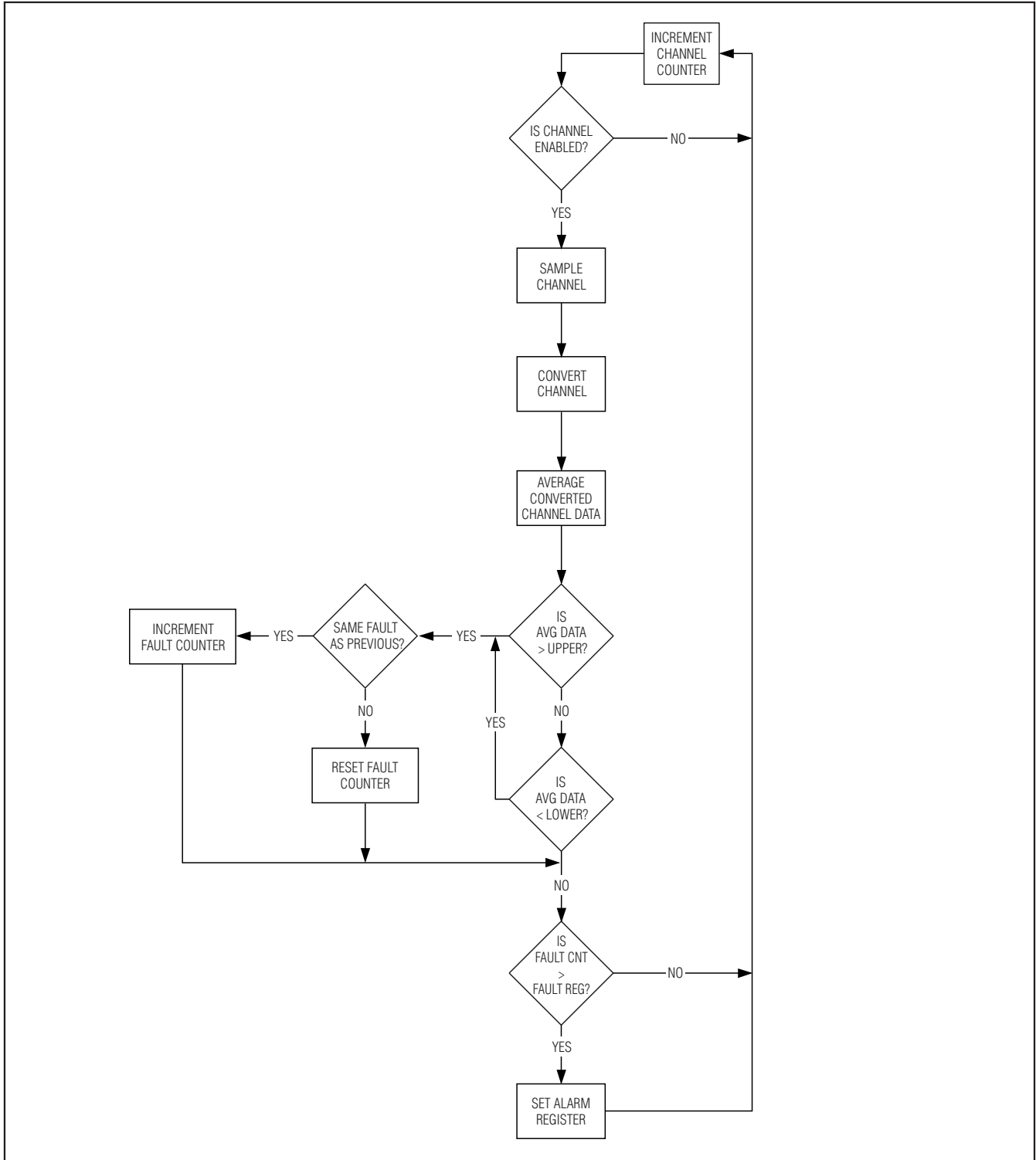

Figure 4. Alarm Flowchart

Stand-Alone, 10-Channel, 10-Bit System Monitors with Internal Temperature Sensor and VDD Monitor

MAX1153/MAX1154

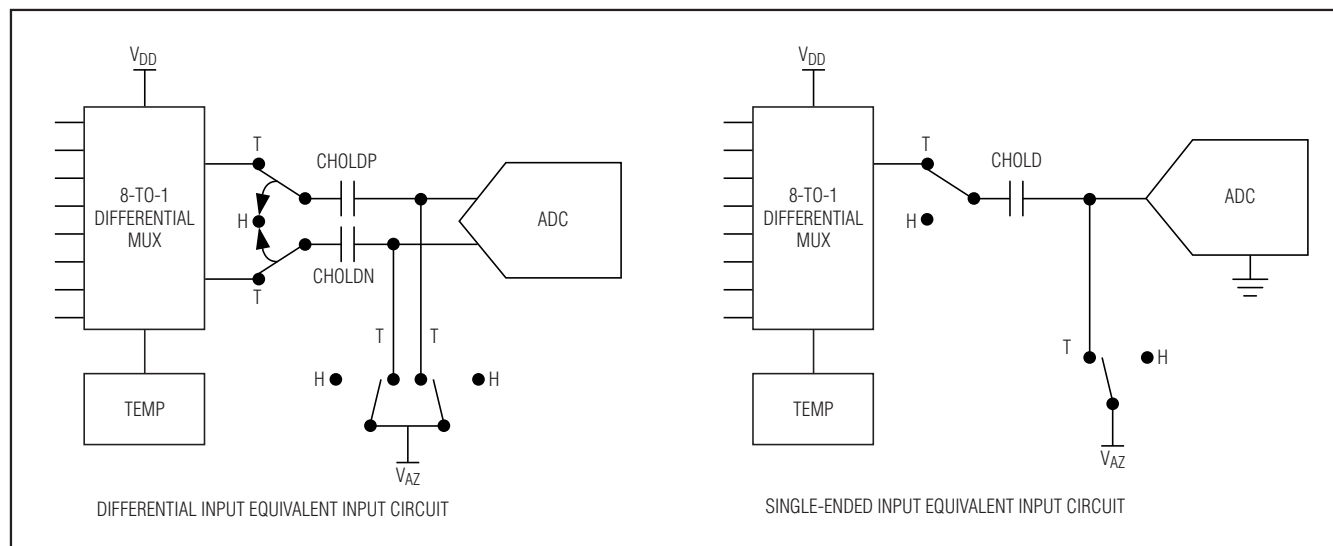

Figure 5. Single-Ended/Differential Input Equivalent Input Circuit

In differential mode, the T/H samples the difference between two analog inputs, eliminating common-mode DC offsets and noise. See the *Input Configuration Register* section and Tables 5 and 6 for more details on configuring the analog inputs.

Unipolar/Bipolar

When performing differential conversions, the input configuration register (Tables 5 and 6) also selects between unipolar and bipolar operation. Unipolar mode sets the differential input range from 0 to V_{REF} . A negative differential analog input in unipolar mode causes the digital output code to be zero. Selecting bipolar mode sets the differential input range to $\pm V_{REF}/2$. The digital output code is straight binary in unipolar mode and two's complement in bipolar mode (see the *Transfer Function* section).

In single-ended mode, the MAX1153/MAX1154 always operate in unipolar mode. The analog inputs are internally referenced to GND with a full-scale input range from 0 to V_{REF} .

Digital Interface

The MAX1153/MAX1154 digital interface consists of five signals: \overline{CS} , SCLK, DIN, DOUT, and INT. \overline{CS} , SCLK, DIN, and DOUT comprise an SPI™-compatible serial interface (see the *Serial Digital Interface* section). INT is an independent output that provides an indication that an alarm has occurred in the system (see the *INT Interrupt Output* section).

Serial Digital Interface

The MAX1153/MAX1154 feature a serial interface compatible with SPI, QSPI™, and MICROWIRE™ devices. For SPI/QSPI, ensure that the CPU serial interface runs in master mode so it generates the serial clock signal.

Select a serial clock frequency of 10MHz or less, and set clock polarity (CPOL) and phase (CPHA) in the μP control registers to the same value, one or zero. The MAX1153/MAX1154 support operation with SCLK idling high or low, and thus operate with CPOL = CPHA = 0 or CPOL = CPHA = 1.

SPI and QSPI are trademarks of Motorola, Inc.
MICROWIRE is a trademark of National Semiconductor Corp.

Stand-Alone, 10-Channel, 10-Bit System Monitors with Internal Temperature Sensor and VDD Monitor

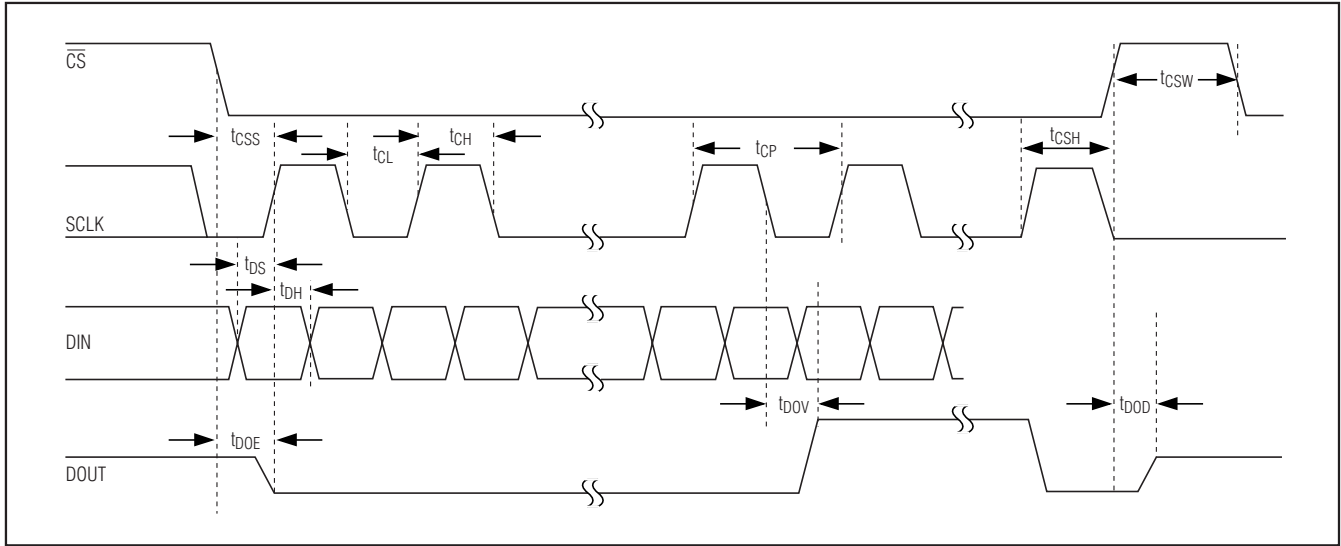

Figure 6. Detailed Serial Interface Timing Diagram

Clock pulses on SCLK shift data into DIN on the rising edge of the SCLK and out of DOUT on the falling edge of SCLK.

Data transfers require a logic low on \overline{CS} . A high-to-low transition of \overline{CS} marks the beginning of a data transfer. A logic high on \overline{CS} at any time resets the serial interface.

See Figure 6 and the *Timing Characteristics* table for detailed serial-interface timing information.

Input Data Format

Serial communications always begin with an 8-bit command word, serially loaded from DIN. A high-to-low transition on \overline{CS} initiates the data input operation. The command word and the subsequent data bytes (for write operations) are clocked from DIN into the MAX1153/MAX1154 on the rising edges of SCLK. The first rising edge on SCLK, after \overline{CS} goes low, clocks in the MSB of the command word (see the *Command Word* section). The next seven rising edges on SCLK complete the loading of the command word into the internal command register. After the 8-bit command word is entered, transfer 0 to 20 bytes of data, depending on the command. Table 2 shows the number of data bytes for each command.

Output Data Format

Output data from the MAX1153/MAX1154 is clocked onto DOUT on the falling edge of SCLK. Single-ended and unipolar differential measurements are output in straight binary MSB first, with two 8-bytes-per-conversion result, with 2 sub-bits and the last 4 bits padded with zeros. For temperature and bipolar differential voltage measurements, the output is two's complement binary in the same 2-byte format. The MSB of the output data from a read command transitions at DOUT after the falling edge of the 8th SCLK clock pulse following the \overline{CS} high-to-low transition. Table 2 shows the number of bytes to be read from DOUT for a given read command.

Command Word

The command word (Table 1) controls all serial communications and configuration of the MAX1153/MAX1154, providing access to the 44 on-chip registers. The first 4 MSBs of the command word specify the command (Table 2), while the last 4 bits provide address information.

The first rising edge on SCLK, after \overline{CS} goes low, transfers the command word MSB into DIN. The next seven rising edges on SCLK shift the remaining 7 bits into the internal command register (see the *Serial Digital Interface* section).

Table 1. Command Word

B7 (MSB)	B6	B5	B4	B3	B2	B1	B0 (LSB)
Command B3	Command B2	Command B1	Command B0	Address B3	Address B2	Address B1	Address B0

Stand-Alone, 10-Channel, 10-Bit System Monitors with Internal Temperature Sensor and VDD Monitor

Table 2. Command Description

COMMAND WORD	DATA BYTES AFTER COMMAND WORD		COMMAND DESCRIPTION
	BYTES TO DIN	BYTES FROM DOUT	
0000####	0	0	Manually Triggered Conversion
0001xxxx	0	3	Read Alarm Register
0010####	0	2	Read Current Data Register for Selected Channel
0011####	0	20	Read Current Data Register for All Channels
0100####	0	5	Read Configuration Register for Selected Channel
0101xxxx	0	5	Read Global Configuration Registers
0110xxxx	N/A	N/A	Reserved
0111xxxx	0	0	Reset
1000####	0	0	Clear Alarm/Fault for Selected Channels
1001xxxx	0	0	Clear Alarm/Fault for All Channels
1010####	2	0	Write Current Data Register for Selected Channel
1011xxxx	20	0	Write Current Data Registers for All Channels
1100####	5	0	Write Configuration Registers for Selected Channel
1101xxxx	5	0	Write Global Configuration Registers
1110xxxx	N/A	N/A	Reserved
1111xxxx	N/A	N/A	Reserved

= Channel address code, see Table 3.
xxxx = These bits are ignored for this command.

Table 3. Channel Address

ADDRESS IN COMMAND	INPUT
0000	Internal temperature
0001	V _{DD}
0010	AIN0
0011	AIN1
0100	AIN2
0101	AIN3
0110	AIN4
0111	AIN5
1000	AIN6
1001	AIN7
1010	Reserved
1011	Reserved
1100	Reserved
1101	Reserved
1110	Reserved
1111	Reserved

Manually Triggered Conversion (Command Code = 0000)

Before beginning a manual conversion, ensure the scan mode bit in the setup register is zero, because a logic 1 disables manual conversions. The address bits in a Manually Triggered Conversion command select the input channel for conversion (see Table 3). When performing a differential conversion, use the even channel address (AIN0, AIN2, AIN4, AIN6); the command is ignored if odd channel addresses (AIN1, AIN3, AIN5, AIN7) are used for a differential conversion.

After issuing a Manually Triggered Conversion command, bring \overline{CS} high to begin the conversion. To obtain a correct conversion result, \overline{CS} must remain high for a period longer than the reference power-up time (if in power-down mode) plus the conversion time for the selected channel-configured conversion type (voltage or temperature). The conversion's result can then be read at DOUT by issuing a Read Current Data Register for Selected Channel command, addressing the converted channel. See Table 3 for channel addresses.

Stand-Alone, 10-Channel, 10-Bit System Monitors with Internal Temperature Sensor and VDD Monitor

Read Alarm Register (Command Code 0001)

The Read Alarm Register command, 0001, outputs the current status of the alarm register (see Table 11). The address bits in this command are ignored. The alarm register is 24 bits long and outputs in 3 bytes. Table 12 illustrates the encoding of the alarm register.

After receiving an interrupt, read the alarm register to determine the source of the interrupt (see the *Alarm Register* section).

Read Current Data Register for Selected Channel (Command Code 0010)

The Read Current Data Register for Selected Channel command, 0010, outputs the data in the current data register of the selected channel. The address bits following this command select the input channel to be read (see Table 3). The current data register is a 10-bit register. It takes 2 bytes to read its value. See the *Output Data Format* and *Current Data Registers* sections for more details. See Table 3 for channel addresses. Also, see Figure 7.

Read Current Data Register for All Channels (Command Code 0011)

The Read Current Data Registers for All Channels command, 0011, outputs the data in the current data registers of all 10 channels, starting with the internal temperature sensor, then the VDD monitor, followed by AIN0 to AIN7. The address bits following this command are ignored. It takes 20 bytes to read all of the 10 channels' current data registers.

Read Configuration Register for Selected Channel (Command Code 0100)

The Read Configuration Register for Selected Channel command, 0100, outputs the configuration data of the channel selected by the address bits (see Table 3). The first register that shifts out is the upper threshold register (2 bytes), followed by the lower threshold register (2 bytes), ending with the channel configuration register (1 byte), all MSB first. It takes 5 bytes to read all three registers. See the *Channel Registers* section for more details.

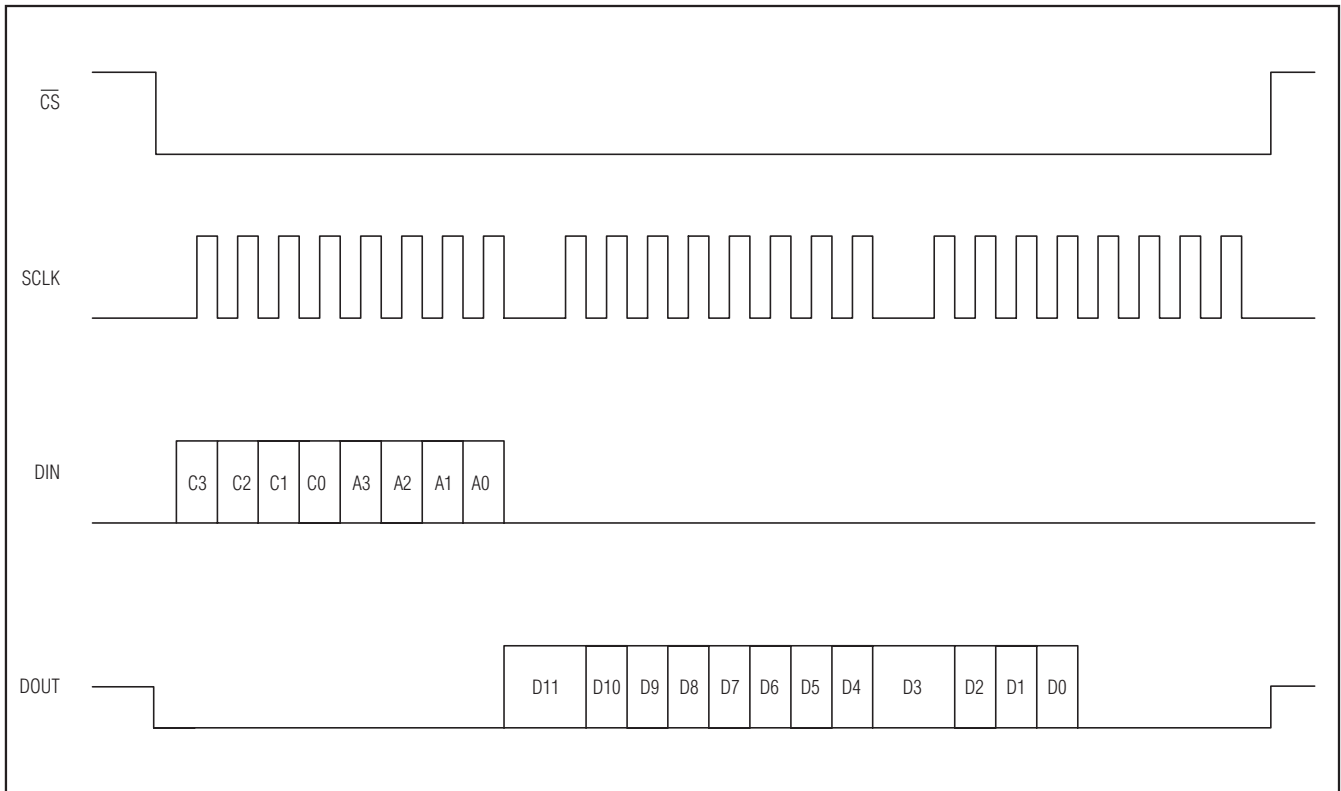

Figure 7. Serial Register Read Timing

Stand-Alone, 10-Channel, 10-Bit System Monitors with Internal Temperature Sensor and VDD Monitor

Read Global Configuration Register (Command Code 0101)

The Read Global Configuration Register command, 0101, outputs the global configuration registers. The address bits following this command are ignored. When the MAX1153/MAX1154 receive a Read Global Configuration Register command, they output 5 bytes of data: 2 bytes from the channel enable register, 2 bytes from the input configuration register, and 1 byte from the setup register, all MSB first. See the *Global Configuration Registers* section for more details.

RESET (Command Code 0111)

The RESET command, 0111, resets the device. This command returns the MAX1153/MAX1154 to their power-on reset state, placing the device into shutdown mode. The address bits in the command are ignored. See the *Power-Up/Reset Defaults Summary* section for more details.

Clear Channel Alarm for Selected Channel (Command Code 1000)

The Clear Channel Alarm command, 1000, clears the alarm bits in the alarm register and resets the fault counter for the addressed channel. See the *Alarm Register* section for more details. See Table 3 for channel addresses.

Clear Alarm Register for All Channels (Command Code 1001)

The Clear Alarm Register for All Channels command, 1001, clears the entire alarm register and resets the fault counters for the internal TEMP sensor, the VDD monitor, and the AIN0–AIN7 channels. The address bits in the command are ignored. See the *Alarm Register* section for more details.

Write Current Data Register for Selected Channel (Command Code 1010)

The Write Current Data Register for Selected Channel command, 1010, writes to the addressed channel's current data register. This command sets an initial condition when using the averaging filter option (see the *Averaging* section). This command can also be used for testing the thresholds, fault counters, and alarm functions (see Figure 8). See Table 3 for channel addresses.

Write Current Data Register for All Channels (Command Code 1011)

The Write Current Data Register for All Channels command, 1011, writes to the current data registers of all channels sequentially, starting with the internal temperature sensor, then the VDD monitor, followed by channels AIN0 to AIN7. The address bits are ignored. Use this command for testing and setting initial conditions when using the averaging filter option (see the *Averaging* section).

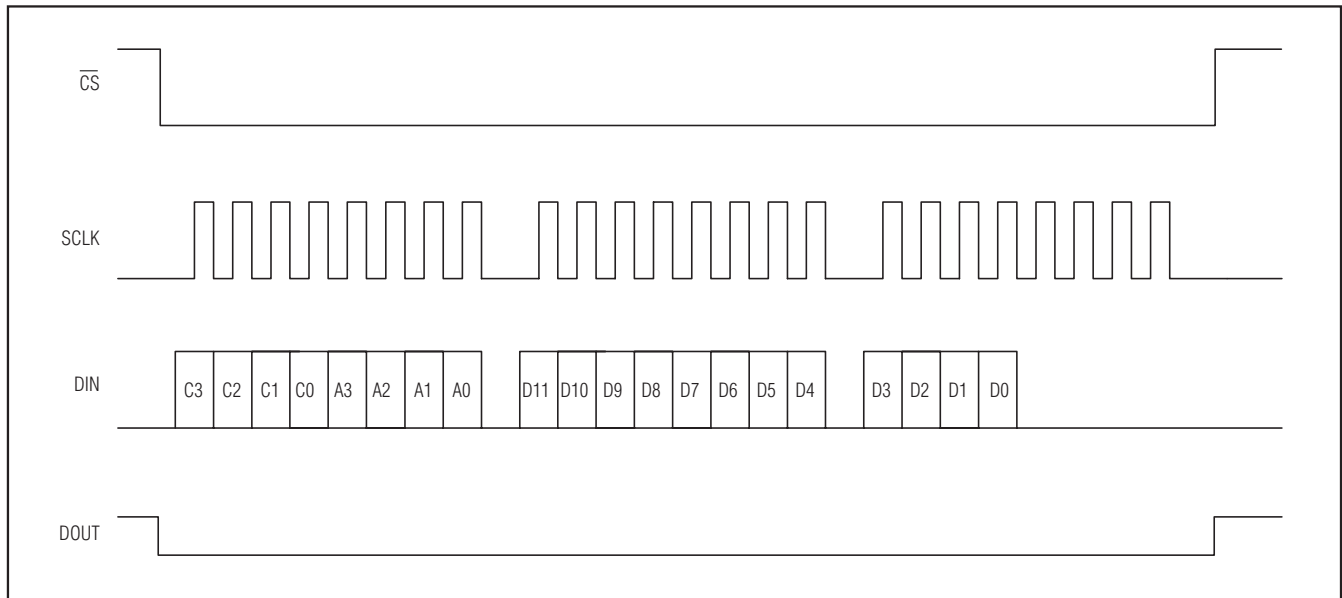

Figure 8. Serial Register Write Timing

Stand-Alone, 10-Channel, 10-Bit System Monitors with Internal Temperature Sensor and VDD Monitor

Write-Selected Channel Configuration Registers (Command Code 1100)

The Write-Selected Channel Configuration Register command, 1100, writes to the three channel configuration registers for the addressed channel (see Table 3). The first register to be written is the upper threshold (2 bytes), followed by the lower threshold (2 bytes), ending with the channel configuration register (1 byte), all MSB first.

Writing to the configuration registers resets the alarm register bits and the fault counters for the addressed channel. See the *Channel Registers* section for more details.

Write Global Configuration Registers (Command Code 1101)

The Write Global Configuration Registers command, 1101, writes to three registers: the channel-enable register (2 bytes), the input configuration register (2 bytes), and the setup register (1 byte). The command address bits are ignored. See the *Global Configuration Registers* section for more details.

Global Configuration Registers

The global configuration registers consist of the channel-enable register, the input configuration register, and the setup register. These registers hold configuration data common to all channels.

Channel-Enable Register

The channel-enable register (Table 4) controls which channels are converted while in automatic scan mode. The register contents are ignored for manual conversion commands. Each input channel has a corresponding bit in the channel-enable register. A logic high enables the corresponding analog input channel for conversion, while a logic low disables it. In differential configuration, the bits for odd channels are ignored. At power-up and after a RESET command, the register contents default to 1111111111b (all channels enabled).

Input Configuration Register

The input configuration register (Table 5) stores the configuration code for each channel as a 3-bit per channel-pair code (see Table 6), selecting from five input signal configurations: single-ended unipolar voltage, single-ended temperature, differential unipolar voltage, differential bipolar voltage, and differential temperature. Table 5 shows the input configuration register format, and Table 6 shows the 3-bit encoding for channel configuration. At power-up and after a RESET command, the register contents defaults to 00000000000b (all inputs single ended).

Table 4. Channel-Enable Register Format

B11 (MSB)	B10	B9	B8	B7	B6	B5	B4	B3	B2	B1	B0 (LSB)
TEMP	VDD	AIN0	AIN1	AIN2	AIN3	AIN4	AIN5	AIN6	AIN7	Res	Res

Table 5. Input Configuration Register Format

B11 (MSB)	B10	B9	B8	B7	B6	B5	B4	B3	B2	B1	B0 (LSB)
AIN0 and AIN1 configuration		AIN2 and AIN3 configuration		AIN4 and AIN5 configuration		AIN6 and AIN7 configuration					

Table 6. Channel Configuration Coding (3 Bits/Channel Pair)

CODE	AIN0, AIN2, AIN4, AIN6 CONFIGURATION	AIN1, AIN3, AIN5, AIN7 CONFIGURATION
000	Single-ended input (power-up state)	Single-ended input (power-up state)
001	Single-ended input	Single-ended, external temperature sensor input
010	Single-ended, external temperature sensor input	Single-ended input
011	Single-ended, external temperature sensor input	Single-ended, external temperature sensor input
100	Differential unipolar encoded, positive input	Differential unipolar encoded, negative input
101	Differential bipolar encoded, positive input	Differential bipolar encoded, negative input
110	Differential external temperature sensor, positive input	Differential external temperature sensor, negative input
111	Reserved	Reserved

Stand-Alone, 10-Channel, 10-Bit System Monitors with Internal Temperature Sensor and VDD Monitor

Setup Register

The 8-bit setup register (Table 7) holds configuration data common to all input channels. At power-up and after a RESET command, this register defaults to 00000000b.

Setup Register: Sample Wait Bits (B7, B6, B5)

These 3 bits in the setup register (Table 8) set the wait time between conversion scans. The following are examples of how the MAX1153/MAX1154 begin a sample sequence (see the *Setup Register: Reference Selection Bits (B1/B0)* section).

Operating in reference mode 00 (external reference for voltage conversions, internal reference for temperature conversions):

- 1) Convert the first-enabled channel. If this channel is a temperature measurement, power up the internal reference (this takes 20 μ s for each enabled temperature measurement in reference mode 00).
- 2) Sequence to the next-enabled channel until all channels have been converted.
- 3) Wait the sample wait period.
- 4) Repeat the procedure.

Operating in reference mode 01 (internal reference for all conversions, can be powered down between scans):

- 1) Power up the internal reference, if powered down (this takes 40 μ s).
- 2) Convert the first-enabled channel, starting with the internal temperature sensor, if enabled.

- 3) Sequence to the next-enabled channel until all enabled channels have been converted.
- 4) Wait the sample wait time, and enter internal reference power-down mode if this period is greater than 80 μ s.
- 5) Repeat the above steps.

Operating in reference mode 10 (internal reference for all conversions, continuously powered up):

- 1) Convert the first-enabled channel.
- 2) Sequence to the next-enabled channel until all enabled channels have been converted.
- 3) Wait the sample wait time.
- 4) Repeat the procedure.

Use the sample wait feature to reduce supply current when measuring slow-changing analog signals. This power savings occurs when reference mode 00 or 01 is used in combination with wait times longer than 80 μ s. With reference mode 10 or wait times of less than 80 μ s, the internal reference system remains powered up, minimizing any power savings. See the *Computing Data Throughput* section. Table 8 shows the B7, B6, B5 wait time encoding.

Setup Register: Interrupt Control (B4, B3)

Bits B3 and B4 in the setup register configure INT and how it responds to an alarm event (see the *Alarm Register* section). Table 9 shows the available INT options.

Table 7. Setup Register Format

B7 (MSB)	B6	B5	B4	B3	B2	B1	B0 (LSB)
Sample wait bits			Interrupt active	Interrupt polarity	Scan mode	Reference source B1	Reference source B2

Table 8. Wait Time Encoding

B7, B6, B5	WAIT TIME (ms)
000	0
001	0.080
010	0.395
011	1.310
100	4.970
101	19.600
110	78.200
111	312.000

Table 9. Interrupt Control

BIT	FUNCTION	BIT STATE	INT OPERATION
B4	Output driver type	1	Driven high or low at all times
		0	High-Z when inactive, driven (high or low) when active
B3	Output polarity	1	Active high, inactive = low or high -Z
		0	Active low, inactive = high or high -Z

Stand-Alone, 10-Channel, 10-Bit System Monitors with Internal Temperature Sensor and V_{DD} Monitor

Setup Register: Scan Mode Bit (B2)

The scan mode bit selects between automatic scanning and manual conversion mode.

When set (B2 = 1), the MAX1153/MAX1154 enter automatic scanning mode and convert every enabled channel starting with the internal temperature sensor, followed by the V_{DD} monitor, then sequencing through AIN0 to AIN7.

After converting all the enabled channels, the MAX1153/MAX1154 enter a wait state set by the sample wait bits in the setup register. After completing the sample wait time, the scan cycle repeats.

When B2 = 0, the MAX1153/MAX1154 are in manual mode and convert only the selected channel after receiving a Manually Triggered Conversion command (see the *Manually Triggered Conversion (Command Code 0000)* section). Whether in automatic scanning mode or manual mode, a Read Current Data Register for Selected Channel command outputs the last-completed conversion result for the addressed channel at DOUT.

Table 10. Reference Selection

B1	B0	REFERENCE MODE
0	0	Voltage measurements use external reference, while temperature measurements use the internal reference. A 20 μ s reference startup delay is added prior to each temperature measurement in this mode. This is the default mode after power-up and after a software RESET.
0	1	All measurements use the internal reference. A 40 μ s reference startup delay is added prior to starting the scanning of enabled channels, allowing the internal reference to stabilize. Note: For sample wait times less than 80 μ s, the reference is continuously powered when in automatic scan mode.
1	0	All measurements use the internal reference. By selecting this mode, the reference is powered up immediately when CS goes high after writing this configuration. Once the reference system is powered up, no further delay is added.
1	1	Reserved.

Table 11. Alarm Register Format

B23/B22	B21/B20	B19/B18	B17/B16	B15/B14	B13/B12	B11/B10	B9/B8	B7/B6	B5/B4	B3/B2	B1/B0
TEMP	V _{DD}	AIN0	AIN1	AIN2	AIN3	AIN4	AIN5	AIN6	AIN7	Res	Res

Setup Register: Reference Selection Bits (B1, B0)

The MAX1153/MAX1154 can be used with an internal or external reference. Select between internal and external reference modes through bits B1 and B0 of the setup register (see Table 10).

Alarm Register

The alarm register (Table 11) holds the current alarm status for all of the monitored signals. This 24-bit register can only be read and cleared. The alarm register has 2 bits for each external input channel, 2 for the onboard temperature sensor, and 2 for the V_{DD} monitor (see Table 12). At power-up, these bits are logic low, indicating no alarms at any input. When any bit in the alarm register is set, INT becomes active and remains active until all alarm bits are cleared. After a fault counter exceeds the set threshold, the alarm register bits for that particular channel are updated to indicate an alarm.

To clear the interrupt, reset the active alarm bit with the Clear Alarm Register command, Clear Channel Alarm command, a RESET command, or by writing a new configuration to the faulting channel. The alarm register defaults to 000000 hex.

Table 11 illustrates how the alarm register stores the information on which channel a fault has occurred. The alarm code for each bit pair is shown in Table 12.

Channel Registers

Each channel (internal temperature sensor, V_{DD} monitor, and AIN0 to AIN7) has registers to hold the conversion result (current data register) and channel-specific configuration data. The channel-specific configuration registers include: the upper threshold register, the lower threshold register, and the channel configuration register. In differential mode, only the registers for the even channel of the differential input pair are used. The channel-specific configuration registers for the odd channel of a differential channel pair are ignored.

Table 12. Alarm Register Coding (2 Bits/Channel)

CODE	DESCRIPTION
00	No alarm (power-up state)
01	Input is below lower threshold
10	Input is above upper threshold
00	Reserved

Stand-Alone, 10-Channel, 10-Bit System Monitors with Internal Temperature Sensor and VDD Monitor

Table 13. Channel Configuration Register Format

B7 (MSB)	B6	B5	B4	B3	B2	B1	B0 (LSB)
Fault B3	Fault B2	Fault B1	Fault B0	Ave B3	Ave B2	Ave B1	Ave B0

Table 14. Conversion Average Encoding

CODE	N
0000	1, no averaging
0001	2
0010	4
0011	8
0100	16
0101	32
0110	64
0111	128
1000	256
1001	512
1010	1024
1011	2048
1100	Reserved
1101	Reserved
1110	Reserved
1111	Reserved

Channel Configuration Register

Each channel has a channel configuration register (Table 13) defining the number of consecutive faults to be detected before setting the alarm bits and generating an interrupt, as well as controlling the digital averaging function. At power-up and after a RESET command, the register defaults to 00 hex (no averaging, alarm on first fault).

Fault Bits

The value stored in the fault bits (B7–B4) in the channel configuration register sets the number of faults that must occur for that channel before generating an interrupt. Encoding of the fault bits is straight binary with values 0 to 15. A fault occurs in a channel when the value in its current data register is outside the range defined by the channel's upper and lower threshold registers. For example, if the number of faults set by the fault bits is N, an interrupt is generated when the number of consecutive faults (see following note) reach (N + 1). The fault bits default to 0 hex at power-up.

Note: Consecutive faults are those happening in consecutive conversion scans for the same channel. If a fault occurs and the next scan finds the input within the

normal range defined by the thresholds, the fault counter resets. If the next counter finds the input signal outside the opposite threshold, rather than the previous one, the fault counter also resets. The fault counter increments only when counting consecutive faults exceeding the same threshold (Figure 4).

Averaging

The averaging calculated by the data-acquisition algorithm of the MAX1153/MAX1154 improves the input signal-to-noise ratio (SNR) by reducing the signal bandwidth digitally. The formula below describes the filter implemented in the MAX1153/MAX1154:

$$\text{current value} = [(N - 1) / N] \times \text{past value} + [(\text{present value}) / N]$$

where N = number of samples indicated in Table 14.

The averaging bits (B3–B0) in the channel configuration register can set the N factor to any value in Table 14.

The output of the filter-running algorithm is continuously available in the current data register. The starting value used by the algorithm is the initial state of the current data register. The current data register is reset to mid-scale (200 hex) at power-up or after a RESET command, but it can be loaded with a more appropriate initial value to improve the filter settling time.

At power-up or after a RESET command, the B3–B0 bits of the channel configuration register are set to 0 hex, corresponding to a number of averaged N = 1, no averaging. See Table 13 and the *Write-Selected Channel Configuration Registers* section for programming details. See Table 14 for N encoding.

As in all digital filters, truncation can be a cause of significant errors. In the MAX1153/MAX1154, 24 bits of precision are maintained in the digital averaging functions, maintaining a worst-case truncation error of well below an LSB. The worst-case truncation error in the MAX1153/MAX1154 is given by the following:

$$\text{worst-case truncation error} = \frac{N-1}{16384} \text{LSBs}$$

where N = number of conversions averaged.

Therefore, the worst truncation error when averaging 256 samples is 0.01557 LSBs.

Stand-Alone, 10-Channel, 10-Bit System Monitors with Internal Temperature Sensor and VDD Monitor

Upper Threshold Register

A conversion result greater than the value stored in the upper threshold register results in a fault, increasing the internal fault counter by one. When the fault count exceeds the value stored in fault bits B7–B4 of the channel configuration register, the channel's alarm bits in the alarm register are set, resulting in an interrupt on INT.

The upper threshold register data format must be the same as the input channel. When the input channel is configured for single-ended or differential unipolar voltage measurements, data stored in the upper threshold register is interpreted as straight binary. For input channels configured for temperature measurements or as differential bipolar voltage inputs, the upper threshold register data is interpreted as two's complement. Load the register with 3FF hex to disable upper threshold faults in unipolar mode, and 1FF hex in temperature or bipolar mode. The power-up/reset default is 3FF hex. See the *Command Word* section on how to read/write to the upper threshold registers.

Lower Threshold Register

Conversion results lower than the value stored in the lower threshold register increment the internal fault counter. Considerations about channel configuration register fault bits B7–B4, INT interrupts, and data format are the same as for the upper threshold register. Set the register to 200 hex to disable lower threshold faults in unipolar mode, or to 200 hex in temperature or bipolar mode. The power-up/reset default is 000 hex. See the *Command Word* section on how to read/write to the lower threshold registers.

Current Data Registers

The current data register holds the last conversion result or the digitally averaged result, when enabled (see the *Averaging* section). The current data registers default to 800 hex at power-up/reset and can be read from and written to through the serial interface. See the *Command Word* section on how to read/write to the current data registers.

INT Interrupt Output

INT provides an indication that an alarm has occurred in the system. It can be programmed (see Table 9) to operate as a push-pull digital output or as an open-drain output (requiring either a pullup or a pulldown resistor) for wired-OR interrupt lines. Bits B3 and B4 in the setup register configure INT and determine its response to an alarm event.

When an internal fault counter exceeds the threshold stored in the fault bits (B7–B4) of the corresponding channel configuration register, the alarm bits for that particular

channel are updated to indicate an alarm. When any bit in the alarm register is set, the INT output becomes active, and stays active until all alarm bits are cleared. See the *Alarm Register* section for more information.

Servicing Interrupts at INT

After detecting an interrupt on INT, the μC 's interrupt routine should first read the alarm register to find the source of the alarm and reset the alarm bits by using any of the methods described in the *Alarm Register* section. Then it can continue with any other action required by the application to react to the alarm.

Note: Multiple alarm conditions can be present. The INT remains active until all alarm conditions have been cleared.

Performing Conversions

At power-up or after a RESET command, the MAX1153/MAX1154 default to shutdown mode with all channels enabled, set for single-ended voltage measurements, and with the scan mode set to manual. Start a conversion by issuing a manually triggered conversion command with the address bits of the channel selected (see the *Manual Conversion* section for more details) or by setting automatic scan mode. To place the MAX1153/MAX1154 in automatic scan mode, set the scan mode bit B2 in the setup register to logic 1.

In automatic scan mode, the MAX1153/MAX1154 convert all enabled channels starting with the internal temperature sensor, followed by the VDD monitor, then by AIN0 to AIN7. As the scan sequence progresses, the analog inputs are converted and the resulting values are stored for each channel into its current data register. Once the scan cycle completes, the MAX1153/MAX1154 wait a period determined by the sample wait bits (B7, B6, B5) in the setup register and then repeat the scan cycle.

After configuring the MAX1153/MAX1154 with automatic scan mode enabled, the devices do not require any intervention from the system μC until an alarm is triggered. All conversion and monitoring functions can continue running indefinitely.

Manual Conversion

In manual mode (scan mode bit in the setup register set to zero, the default after power-up/reset), the MAX1153/MAX1154 convert individual channels with the Manually Triggered Conversion command. Assuming that, either by power-up/RESET defaults or by previous initialization, the channel to be addressed is both enabled and configured for the type of signal to be acquired (voltage/temperature, single ended/differential, or unipolar/bipolar), carry out the following steps to

Stand-Alone, 10-Channel, 10-Bit System Monitors with Internal Temperature Sensor and VDD Monitor

execute a manual conversion. See Figure 9 for manual conversion timing:

- 1) Disable autoscan (set up register scan mode bit to zero), if necessary.
- 2) Pull CS low.
- 3) Initiate a conversion by issuing a Manually Triggered Conversion command (0000, followed by the address bits of the channel to be converted).
- 4) Pull CS high to start the conversion.
- 5) Maintain a logic high on CS to allow for reference power-up (if the reference mode requires it) and conversion time.
- 6) Pull CS low.
- 7) Issue a Read Current Data Register for Selected-Channel command (0010, followed by the same address of the channel in the Manually Triggered Conversion command).

Voltage Measurements

Every voltage measurement (internal V_{DD} or external input channel) requires 10.6μs to complete. If the internal reference needs to power up (reference mode = 01), an additional 40μs is required every time the MAX1153/MAX1154 come out of automatic shutdown mode after a sample wait period greater than 80μs.

Monitoring V_{DD}

This internal acquisition channel samples and converts the supply voltage, V_{DD}.

V_{DD} value can be calculated from the digitized data with the following equation:

$$V_{DD} = 2 \times (\text{current_data_register_content}) \times \left(\frac{V_{REF}}{1024} \right)$$

The reference voltage must be larger than 1/2V_{DD} for the operation to work properly. V_{DD} monitoring requires 10.6μs (typ) per measurement.

Temperature Measurement

The MAX1153/MAX1154 perform temperature measurement by measuring the voltage across a diode-connected transistor at two different current levels. The following equation illustrates the algorithm used for temperature calculations:

$$\text{temperature} = (V_{HIGH} - V_{LOW}) \times \frac{\frac{q}{k}}{n \times \ln \left[\frac{I_{HIGH}}{I_{LOW}} \right]}$$

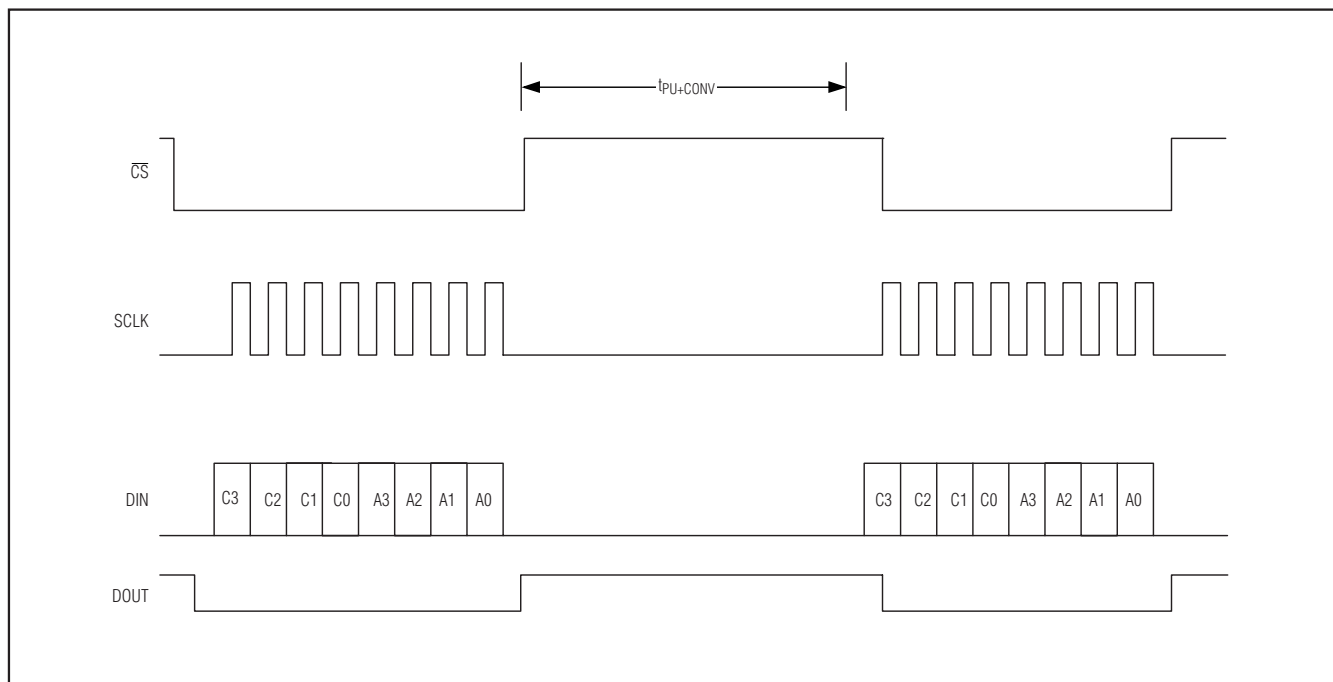

Figure 9. Manual Conversion Timing Without Reading Data

Stand-Alone, 10-Channel, 10-Bit System Monitors with Internal Temperature Sensor and VDD Monitor

where:

V_{HIGH} = sensor-diode voltage with high current flowing (I_{HIGH})

V_{LOW} = sensor-diode voltage with low current flowing (I_{LOW})

q = charge of electron = 1.602×10^{-19} coulombs

k = Boltzman constant = 1.38×10^{-23} J/K

n = ideality factor (slightly greater than 1)

The temperature measurement process is fully automated in the MAX1153/MAX1154. All steps are sequenced and executed by the MAX1153/MAX1154 each time an input channel (or an input channel pair) configured for temperature measurement is scanned.

The resulting 10-bit, two's complement number represents the sensor temperature in degrees Celsius, with 1 LSB = $+0.5^{\circ}\text{C}$.

The MAX1153/MAX1154 support both single-ended and differential temperature measurements.

Applications Information

Setting Up the MAX1153/MAX1154 Subsystem

The MAX1153/MAX1154 are autonomous subsystems, requiring only initialization to scan, convert, and monitor the voltage signals or the temperature sensors connected to their input channels.

For simple applications, using any number of the input channels and any combination of voltage/temperature and unipolar/differential, with no interrupt generation required, use the following initialization procedure:

- Issue a Write Global Configuration Registers command. This is a single, 5-byte write operation that configures the input channels, enables the channels to be used, sets the sample wait time between scans, configures the interrupt output INT, selects

the reference mode, and starts the automatic scan mode. See the Write Global Configuration Registers Command section, Table 2, and Tables 5–10.

Immediately after the global configuration register is loaded, the MAX1153/MAX1154 begin to update the current data registers. Acquire conversion data from the MAX1153/MAX1154 by issuing a command to read a specific channel with the Read Current Data Register for Selected Channel command. Read all current data register at once with the Read Current Data Registers for All Channels command.

For more complex applications, the monitoring and interrupt generation features of the MAX1153/MAX1154 require a second step of initialization. Each enabled channel to be monitored requires configuration using a Write Configuration Register for Selected Channel command. Each command is a 5-byte write that sets the upper and lower fault thresholds, the number of faults for an alarm before an interrupt is generated, and an average algorithm parameter if the application requires input signal filtering.

Applications can read the current data registers and respond to interrupts signaled by the INT output (see the *Servicing Interrupts at INT* section).

All the MAX1153/MAX1154 registers can be verified by reading back written data, including the configuration registers. This feature is useful for development and testing (see Table 2).

Power-Up/Reset Defaults Summary

Setup Register Power-Up/Reset Defaults

At initial power-up or after a RESET command, the setup register resets to 00 hex. Consequently, the MAX1153/MAX1154 are configured as follows:

- Sample wait time is 0 μs .
- INT output is open drain and outputs an active-low signal to signify an alarm.

Table 15. Power-Up/Reset Defaults Summary

REGISTER	BIT RANGE	POWER-UP/RESET STATE	COMMENT
Setup	B0 to B7	All 0s	See <i>Setup Register Power-Up/Reset Defaults</i>
Channel enable	B0 to B11	All 1s	All channels (int/ext) enabled
Input configuration	B0 to B11	All 0s	All single-ended voltage inputs
Alarm register	B0 to B23	All 0s	No alarms set
Channel configuration	B0 to B7	All 0s	Faults = 0, no averaging
Upper threshold	B0 to B9	All 1s	All upper thresholds max range
Lower threshold	B0 to B9	All 0s	All lower thresholds min range
Current data registers	B0 to B9	200hex	Set at midrange

Stand-Alone, 10-Channel, 10-Bit System Monitors with Internal Temperature Sensor and VDD Monitor

- Manual conversion mode
- External reference for voltage measurements

Channel Enable Register Power-Up/Reset Defaults

At power-on or after a RESET command, the channel enable register resets to FF hex, enabling all channels: the internal temperature sensor, the VDD monitor, and AIN0–AIN7.

Input Configuration Register Power-Up/Reset Defaults

At power-on or after a RESET command, the input configuration register resets to 00 hex, configuring AIN0–AIN7 for single-ended voltage measurement.

Alarm Register Power-Up/Reset Defaults

At power-on or after a RESET command, the alarm register is reset to 000000 hex, indicating that no alarm condition exists.

Current Data Register Power-Up/Reset Defaults

At power-on or after a RESET command, each channel's current data register is reset to 200 hex.

Upper Threshold Register Power-Up/Reset Defaults

At power-on or after a RESET command, each channel's upper threshold register is reset to 3FF hex. This state effectively disables the upper threshold.

Lower Threshold Register Power-Up/Reset Defaults

At power-on or after a RESET command, each channel's lower threshold register is reset to 000 hex. This state effectively disables the lower threshold.

Channel Configuration Register Power-Up/Reset Defaults

At power-on or after a RESET command, each channel's configuration register is reset to 000 hex, which configures the fault bits to cause an alarm to occur on the first overrange or underrange condition and disables averaging.

Computing Data Throughput

The MAX1153/MAX1154 throughput rate depends on the number of enabled channels, their configuration (temperature or voltage), and the reference mode. Voltage measurements require 10.6μs (typ) to complete, and temperature measurements require 46μs.

Channel pairs configured for differential measurements count as only one for throughput computation.

The reference system takes 20μs to power up in reference mode 00 prior to each temperature measurement, 40μs to power up in reference mode 01 after each sam-

ple wait period (if sample wait time > 80μs), and no power-up time in reference mode 10.

The sampling period is calculated as follows:

$$t_{sw} = (t_{pu}) + (N_v)t_{conv[volt]} + (N_t)t_{conv[temp]} + t_{wait}$$

where:

t_{sw} = all channels scan sampling period

t_{pu} = reference power-up time

$t_{conv[volt]}$ = voltage-configured channel conversion time

N_v = number of voltage-configured channels

$t_{conv[temp]}$ = temperature-configured channel conversion time

N_t = number of temperature-configured channels

t_{wait} = sample wait time

The terms in the previous equation are determined as shown by the number of enabled channels, the input channel configuration (voltage vs. temperature), the sample wait time, and the reference mode. The following calculation shows a numeric example:

$$t_{sw} = 40\mu s + 8 \times 10.6\mu s + 2 \times 46\mu s + 395\mu s = 611.8\mu s$$

- 40μs is the time required for the reference to power-up (reference mode = 00) every time the MAX1153/MAX1154 come out of automatic shutdown mode after a sample wait period.
- 8 × 10.6μs is the time required for seven channels configured for voltage measurement and the VDD monitor.
- 2 × 46μs is the time required for temperature measurement (46μs for each temperature measurement (internal or external)).
- 395μs is the sample wait time, set by bits B5, B6, B7 of the setup register (see Tables 7 and 8).

The MAX1153/MAX1154 use an internal clock for all conversions. The serial interface clock does not affect conversion time.

Performing eight single-ended remote channels temperature measurements, an internal temperature measurement, and an internal VDD measurement with a sample wait time of zero results in an average conversion rate of 24ksps or 2.4ksps per channel.

Performing eight single-ended voltage measurements, an internal temperature measurement, and an internal VDD measurement with sample wait time of zero results in an average conversion rate of 70ksps or 7ksps per channel.

Stand-Alone, 10-Channel, 10-Bit System Monitors with Internal Temperature Sensor and VDD Monitor

Automatic Reference Shutdown

The MAX1153/MAX1154 enter an automatic shutdown mode when in reference mode 00 or when the sample wait is greater than 80 μ s in reference mode 01. Using either of these reference modes and a sample wait period as long as the application allows results in the lowest power consumption.

Temperature Measurement

The MAX1153/MAX1154 support both single-ended and differential temperature measurements. The design decision between the two types of measurements depends on the desired level of accuracy and on type and/or number of temperature sensors. The superior common-mode rejection and lower noise of the differential mode reduces measurement errors and provides higher accuracy, while single-ended measurements require a lower number of connections, resulting in a simpler implementation and a higher number of monitored points for each MAX1153/MAX1154.

Differential Temperature Measurement

Connect the anode of a diode-connected transistor to the even input channel and the cathode to the odd input channel of an input pair configured for differential temperature measurement (AIN0/AIN1, AIN2/AIN3, AIN4/AIN5, or AIN6/AIN7). Run the two sensor connection lines parallel to each other with minimum spacing. This improves temperature measurement accuracy by minimizing the differential noise between the two lines, since they have equal exposure to most sources of noise. For further improved noise rejection, shield the two sensor connections by running them between ground planes, when available.

Configure the MAX1153/MAX1154 inputs for differential temperature measurement in the input configuration register (see Tables 9 and 10) and enable the even channel number in the channel enable register (see Table 4).

Table 16. Remote Sensor Transistor Manufacturers

MANUFACTURER	MODEL NUMBER
Central Semiconductor (USA)	CMPT3904
Fairchild Semiconductors (USA)	MMBT3904
Motorola (USA)	MMBT3904
Rohm Semiconductor (Japan)	SST3904
Siemens (Germany)	SMB3904
Zetex (England)	FMMT3904CT-ND
Diodes Inc.	MMBT3904

Single-Ended Temperature Measurement

Connect the anode of a diode-connected transistor to the input channel and the cathode to ground. Choose ground connections for sensors away from high-current return paths to avoid the introduction of errors caused by voltage drops in the board/system ground, which is the main drawback for single-ended measurements. Practical options for better accuracy are the use of a star-configured subsystem ground or a signal ground plane; to isolate the anode sensor connection trace away from board and system noise sources; or to shield it with ground lines and ground planes (when available) to prevent accuracy degradation in the temperature measurements caused by magnetic/electric noise induction.

Configure the MAX1153/MAX1154 input used for single-ended temperature measurement in the input configuration register (see Tables 9 and 10) and enable the analog input in the channel-enable register (see Table 4).

Remote Temperature Sensor Selection

Temperature-sensing accuracy depends on having a good-quality, diode-connected, small-signal transistor as a sensor. Accuracy has been experimentally verified for 2N3904-type devices. The transistor must be a small-signal type with low base resistance. Tight specifications for forward current gain (+50 to +150, for example) indicate that the manufacturer has good process controls and that the devices have consistent V_{BE} characteristics. CPU on-board sensors and other ICs' on-board temperature-sensing devices can also be used (see Table 16 for recommended devices).

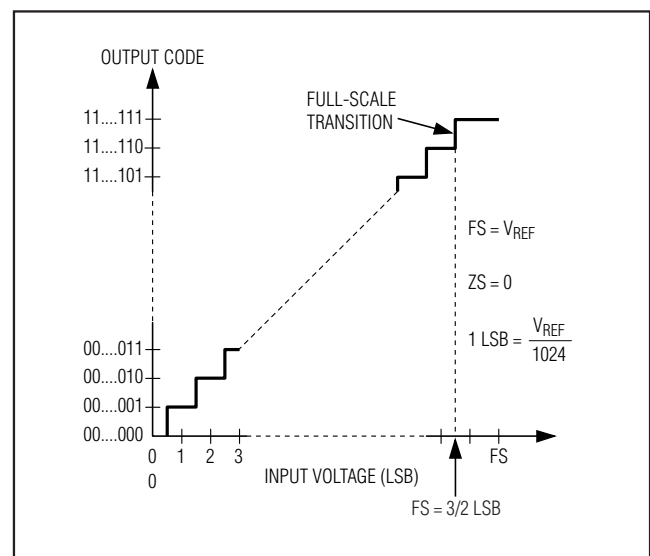

Figure 10. Unipolar Transfer Function, Full Scale (FS) = V_{REF}

Stand-Alone, 10-Channel, 10-Bit System Monitors with Internal Temperature Sensor and VDD Monitor

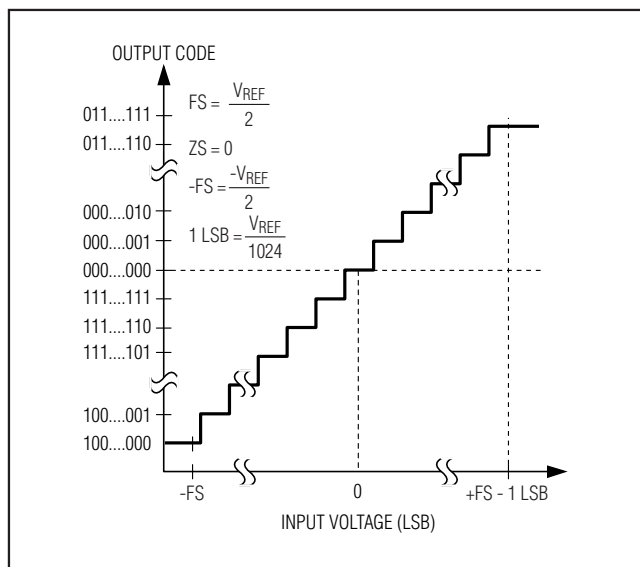

Figure 11. Bipolar Transfer Function, Full Scale ($\pm FS$) = $\pm V_{REF}/2$

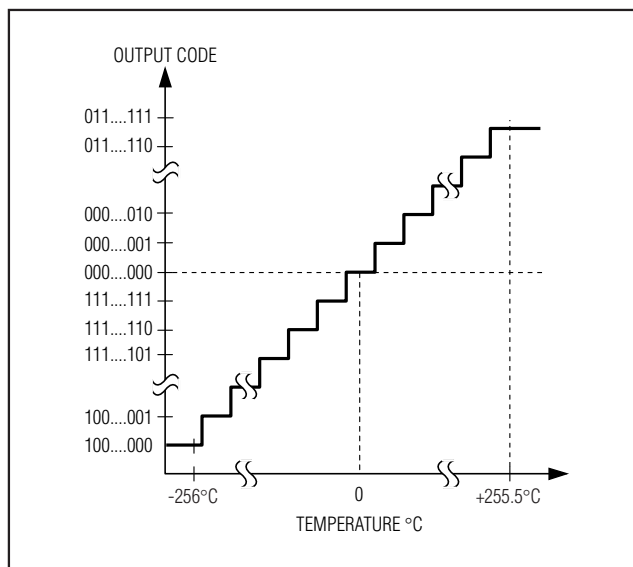

Figure 12. Temperature Transfer Function

Transfer Function

Figure 10 shows the nominal transfer function for single-ended or differential unipolar configured inputs, Figure 11 illustrates the transfer function for differential bipolar conversions, and Figure 12 shows temperature conversions. Code transitions occur halfway between successive-integer LSB values. Output coding is binary, with 1 LSB = 2.44mV (MAX1153) or 4mV (MAX1154) for unipolar and bipolar operation, and 1 LSB = +0.5°C (MAX1153/MAX1154) for temperature measurements.

For unipolar operation, the 0 code level transition is at $[1/2(V_{REF} / 1024)]$.

The FFF hex level transition is at $[1022.5(V_{REF} / 1024)]$.

1 LSB = $V_{REF} / 1024$.

Layout, Grounding, and Bypassing

For best performance, use PC boards. Do not use wire-wrap boards. Board layout should ensure that digital and analog signal lines are separated from each other. Do not run analog and digital (especially clock) signals parallel to one another or run digital lines underneath the MAX1153/MAX1154 package. High-frequency noise in the V_{DD} power supply can affect the MAX1153/MAX1154 performance. Bypass the V_{DD} supply with a 0.1 μ F capacitor from V_{DD} to GND close to the V_{DD} pin. Minimize capacitor lead lengths for best supply-noise rejection. If the power supply is very noisy, connect a 10 Ω resistor in series with the supply to improve power-supply filtering.

Definitions

Integral Nonlinearity

Integral nonlinearity is the deviation of the values on the actual transfer function from a straight line. This straight line can be either a best-straight-line fit or a line drawn between the end points of the transfer function, once offset and gain errors have been corrected. The static linearity parameters for the MAX1153/MAX1154 are measured using the end-point-fit method. INL is specified as the maximum deviation in LSBs.

Differential Nonlinearity (DNL)

Differential nonlinearity is the difference between an actual step width and the ideal value of 1 LSB. A DNL error specification of less than 1 LSB guarantees no missing codes and a monotonic transfer function.

Offset Error

The offset error is the difference between the ideal and the actual analog input value at the first transition of the ADC, usually from digital code 0 to code 1 for straight binary output. For the MAX1153/MAX1154, the transition between code 0 and code 1 should occur at an input voltage of 1/2 LSB, or 1.22mV for the MAX1153 and 2mV for the MAX1154.

Stand-Alone, 10-Channel, 10-Bit System Monitors with Internal Temperature Sensor and VDD Monitor

Gain Error

The gain error is the difference between the ideal and actual value of the analog input difference between the first and last transitions of the ADC output. The first transition is from digital code 0 to code 1, and the last from code (2^{N-2}) to code (2^{N-1}), where N = number of ADC bits for straight binary output code. For the MAX1153/MAX1154, the ideal difference in the input voltage between code transitions 0 to 1 and code transitions 1022 to 1023 is $1022 \times \text{LSB}$. For the MAX1153, this is $2.5\text{V} - 2 \times \text{LSB} = 2.495117$, and for the MAX1154, this is $4.096\text{V} - 2 \times \text{LSB} = 4.088$. Gain error is a DC specification, usually normalized to the FS ideal analog value and given in percent of FSR or ppm.

Signal-to-Noise Ratio

For a waveform perfectly reconstructed from digital samples, signal-to-noise ratio (SNR) is the ratio of the full-scale analog input (RMS value) to the RMS quantization error (residual error). The ideal theoretical minimum analog-to-digital noise is caused by quantization error only, results directly from the ADC's resolution (N bits), and can be calculated with the following equation:

$$\text{SNR} = (6.02 \times N + 1.76)\text{dB}$$

There are other noise sources besides quantization noise, including thermal noise, reference noise, clock jitter, etc. Therefore, SNR is calculated by taking the ratio of the RMS signal to the RMS noise, which includes all spectral components minus the fundamental, the first five harmonics, and the DC offset.

Signal-to-Noise Plus Distortion

Signal-to-noise plus distortion (SINAD) is the ratio of the fundamental input frequency's RMS amplitude to the RMS equivalent of all other ADC output signals:

$$\text{SINAD (dB)} = 20 \times \log (\text{Signal}_{\text{RMS}} / \text{Noise}_{\text{RMS}})$$

There are other noise sources besides quantization noise, including thermal noise, reference noise, clock jitter, etc. Therefore, SINAD is calculated by taking the ratio of the full-scale signal to the RMS noise, which includes all spectral components minus the fundamental and the first five harmonics.

Total Harmonic Distortion (THD)

Total harmonic distortion (THD) is the ratio of the RMS sum of the first five harmonics of the input signal to the fundamental itself. This is expressed as:

$$\text{THD} = 20 \times \log \frac{\left(\sqrt{V_2^2 + V_3^2 + V_4^2 + V_5^2} \right)}{V_1}$$

where V_1 is the fundamental RMS value, and V_2 through V_5 are the RMS values of the 2nd- through 5th-order harmonics, respectively.

Power-Supply Rejection

Power-supply rejection is the ratio between the change in the ADC full-scale output to the change in power-supply voltage when the power-supply voltage is varied from its nominal value. It is specified in V/V or $\mu\text{V}/\text{V}$.

Stand-Alone, 10-Channel, 10-Bit System Monitors with Internal Temperature Sensor and VDD Monitor

Typical Operating Circuit

MAX1153/MAX1154

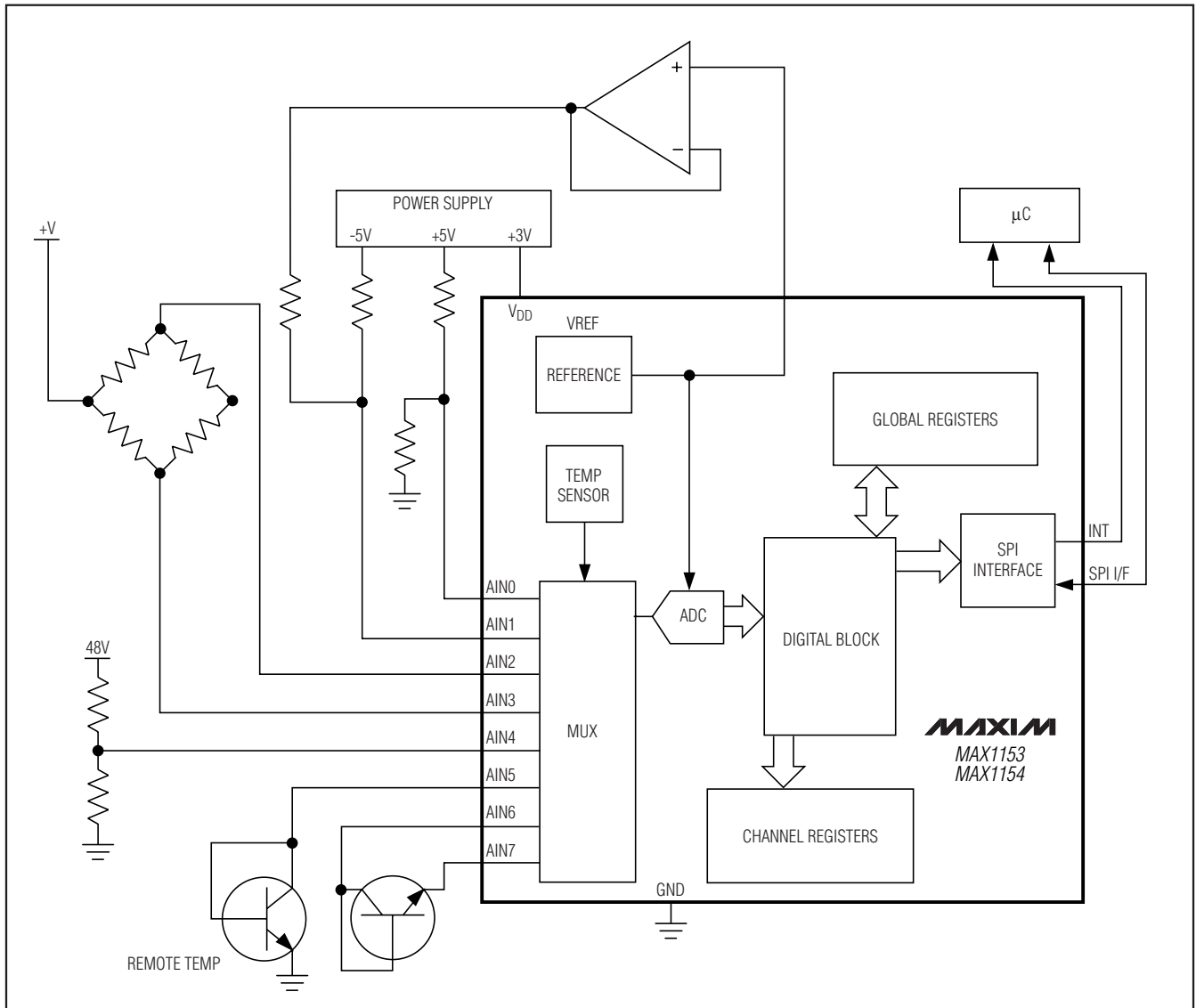

Chip Information

PROCESS: BICMOS

Package Information

For the latest package outline information and land patterns, go to www.maxim-ic.com/packages. Note that a "+", "#", or "-" in the package code indicates RoHS status only. Package drawings may show a different suffix character, but the drawing pertains to the package regardless of RoHS status.

PACKAGE TYPE	PACKAGE CODE	DOCUMENT NO.
16 TSSOP	U16-1	21-0066

Stand-Alone, 10-Channel, 10-Bit System Monitors with Internal Temperature Sensor and VDD Monitor

Revision History



REVISION NUMBER	REVISION DATE	DESCRIPTION	PAGES CHANGED
0	4/03	Initial release	—
1	6/10	Changed voltage characteristics in <i>Electrical Characteristics</i> table, removed A grade parts, and updated specifications	2–9, 11, 15, 18, 21, 22, 25, 29

Maxim cannot assume responsibility for use of any circuitry other than circuitry entirely embodied in a Maxim product. No circuit patent licenses are implied. Maxim reserves the right to change the circuitry and specifications without notice at any time.

30 **Maxim Integrated Products, 120 San Gabriel Drive, Sunnyvale, CA 94086 408-737-7600**

Looking for pricing, stock, or lifecycle information?

Click below to explore more details on WIN SOURCE:

-  [View MAX1154BEUE+ on WIN SOURCE](#)
-  [Maxim Integrated Information](#)

Optimize Your Supply Chain with WIN SOURCE Solutions

-  Global Sourcing Solution
-  Obsolete Management
-  Cost Control Management
-  Shortage Management
-  Alternative Solution
-  Excess Inventory Management