



**THE DATASHEET OF
MAX4993EVB+**





Low RON, Dual-SPDT/Single-DPDT Analog Switches with Slow Turn-On Time

General Description

The MAX4991–MAX4994 low on-resistance analog switches operate from a single +1.8V to +5.5V supply. The MAX4991/MAX4993 feature a slow turn-on time to reduce clicks and pops due to coupling capacitors and audio amplifiers with a DC output bias. This feature provides click-and-pop reduction without adding additional parts for existing architectures.

The MAX4991/MAX4992 are dual single-pole/double-throw (SPDT) switches, while the MAX4993/MAX4994 are double-pole/double-throw (DPDT) switches. The MAX4993/MAX4994 feature an active-low enable input (EN) that sets all the channels to high impedance and reduces supply current when driven high. These devices have 0.3Ω on-resistance and 0.004% THD+N to route high fidelity audio signals.

The MAX4991–MAX4994 are available in space-saving 10-pin UTQFN (1.4mm x 1.8mm) package, and are specified for operation over the -40°C to +85°C extended temperature range.

Applications

Speaker Headset Source Switching
Cellular Phones
Portable MP3 Players
Audio Signal Routing

Typical Application Circuit appears at end of data sheet.

Features

- ◆ Slow Turn-On for Click-and-Pop Reduction Without Additional Parts
- ◆ Low 0.3Ω On-Resistance
- ◆ Low RON Flatness (1mΩ)
- ◆ Low THD+N: 0.004%
- ◆ +1.8V to +5.5V Single-Supply Operation
- ◆ 1.2μA (typ) Supply Current
- ◆ Space-Saving Packages
10-Pin UTQFN (1.4mm x 1.8mm x 0.55mm)

Pin Configurations

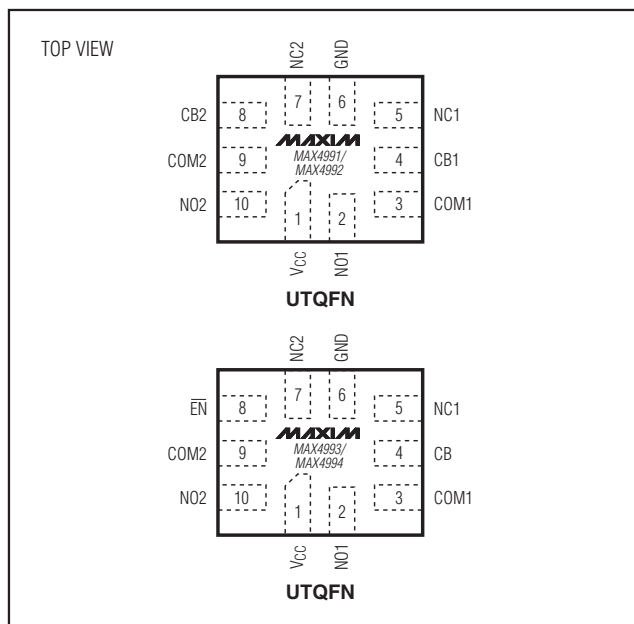

MAX4991–MAX4994

Ordering Information/Selector Guide

PART	PIN-PACKAGE	CONFIGURATION	SLOW-SWITCHING TIME	ENABLE LINE	TOP MARK
MAX4991EVb+*	10 UTQFN	Dual SPDT	Yes	No	AAD
MAX4992EVb+	10 UTQFN	Dual SPDT	No	No	AAE
MAX4993EVb+	10 UTQFN	DPDT	Yes	Yes	AAF
MAX4994EVb+*	10 UTQFN	DPDT	No	Yes	AAG

Note: All devices operate over -40°C to +85°C extended temperature range.

+Denotes a lead(Pb)-free/RoHS-compliant package.

*Future product—contact factory for availability.



Maxim Integrated Products 1

For pricing, delivery, and ordering information, please contact Maxim Direct at 1-888-629-4642, or visit Maxim's website at www.maxim-ic.com.

Low RON, Dual-SPDT/Single-DPDT Analog Switches with Slow Turn-On Time

ABSOLUTE MAXIMUM RATINGS

(Voltages referenced to GND.)

V _{CC} , CB ₋ , EN ₋	-0.3V to +6.0V
COM ₋ , NC ₋ , NO ₋	-0.3V to (V _{CC} + 0.3V)
Continuous Current COM ₋ , NC ₋ , NO ₋	±350mA
Peak Current COM ₋ , NC ₋ , NO ₋ (pulsed at 1ms, 50% duty cycle).....	±700mA
Peak Current COM ₋ , NC ₋ , NO ₋ (pulsed at 1ms, 10% duty cycle).....	±1.5A
Continuous Power Dissipation (T _A = +70°C) 10-Pin UTQFN (derate 6.9mW/°C above +70°C).....	559mW

Junction-to-Case Thermal Resistance (θ_{JC}) (Note 1)

10-Pin UTQFN20.1°C/W

Junction-to-Ambient Thermal Resistance (θ_{JA}) (Note 1)

10-Pin UTQFN143.1°C/W

Operating Temperature Range-40°C to +85°C

Junction Temperature Range+150°C

Storage Temperature Range-65°C to +150°C

Lead Temperature (soldering, 10s)+300°C

Note 1: Package thermal resistances were obtained using the method described in JEDEC specification JESD51-7, using a 4-layer board. For detailed information on package thermal considerations, refer to www.maxim-ic.com/thermal-tutorial.

Stresses beyond those listed under "Absolute Maximum Ratings" may cause permanent damage to the device. These are stress ratings only, and functional operation of the device at these or any other conditions beyond those indicated in the operational sections of the specifications is not implied. Exposure to absolute maximum rating conditions for extended periods may affect device reliability.

ELECTRICAL CHARACTERISTICS

(V_{CC} = +2.7V to +5.5V, T_A = -40°C to +85°C, unless otherwise noted. Typical values are at V_{CC} = +3.0V, T_A = +25°C.) (Note 2)

PARAMETER	SYMBOL	CONDITIONS	MIN	TYP	MAX	UNITS
Power-Supply Range	V _{CC}		1.8		5.5	V
Undervoltage Lockout	V _{UVLO}			1.4		V
Supply Current (MAX4991/MAX4992)	I _{CC}	V _{CB1} = V _{CB2} = 0V or V _{CC}	V _{CC} = +3V	1.2	2.5	μA
			V _{CC} = +5.5V	3.1	6	
		V _{CB1} = V _{CB2} = +0.5V or +1.4V	V _{CC} = +2.7V		3	
			V _{CC} = +5.5V		14	
Supply Current (MAX4993/MAX4994)	I _{CC}	V _{EN} = V _{CC} , V _{CB} = 0V or V _{CC}	V _{CC} = +5.5V	0.1	1	μA
			V _{CC} = +3V	1.2	2.5	
		V _{EN} = 0V, V _{CB} = 0V or V _{CC}	V _{CC} = +5.5V	3.1	6	
			V _{CC} = +2.7V		3	
V _{EN} = V _{CB} = +0.5V or +1.4V	V _{CC} = +5.5V		8.5			
Power-Supply Rejection Ratio	PSRR	R _L = R _S = 50Ω, f = 20kHz		80		dB
Analog Signal Range	V _{NC-} , V _{NO-} , V _{COM-}		0		V _{CC}	V
On-Resistance	R _{ON}	V _{CC} = +2.7V, V _{NC-} or V _{NO-} = 0 to V _{CC} , I _{COM-} = 100mA	T _A = +25°C	0.3	0.5	Ω
			T _A = T _{MIN} to T _{MAX}		0.6	
On-Resistance Match Between Channels	ΔR _{ON}	V _{CC} = +2.7V, between NC ₋ , NO ₋ only, I _{COM-} = 100mA, V _{NC-} or V _{NO-} = V _{CC} /2		3		mΩ
On-Resistance Flatness	R _{FLAT}	V _{CC} = +2.7V, V _{NC-} or V _{NO-} = 0 to V _{CC} , I _{COM-} = 100mA (Note 3)		1		mΩ
COM ₋ Output Noise	N _{COM-}	V _{NC-} = V _{NO-} = 0V, R _L = 50Ω	f = 20Hz to 20kHz	1		μV _{RMS}
			f = 0Hz to 1MHz	50		

Low Ron, Dual-SPDT/Single-DPDT Analog Switches with Slow Turn-On Time

MAX4991-MAX4994

ELECTRICAL CHARACTERISTICS (continued)

($V_{CC} = +2.7V$ to $+5.5V$, $T_A = -40^{\circ}C$ to $+85^{\circ}C$, unless otherwise noted. Typical values are at $V_{CC} = +3.0V$, $T_A = +25^{\circ}C$.) (Note 2)

PARAMETER	SYMBOL	CONDITIONS	MIN	TYP	MAX	UNITS
NC_, NO_ Off-Leakage Current	$I_{L(OFF)}$	$V_{CC} = +2.7V$, switch open, $V_{NC_}$ or $V_{NO_} = 0V$ or V_{CC} , $V_{COM_} = V_{CC}$ or $0V$	-100		+100	nA
COM_ Off-Leakage Current (MAX4993/MAX4994)	$I_{COM_L(OFF)}$	$V_{CC} = +2.7V$, $V_{EN} = V_{CC}$, $V_{NC_}$ or $V_{NO_} = 0V$ or V_{CC} , $V_{COM_} = V_{CC}$ or $0V$	-100		+100	nA
COM_ On-Leakage Current	$I_{COM_L(ON)}$	$V_{CC} = +2.7V$, switch closed, $V_{NC_}$ or $V_{NO_} = 0V$, V_{CC} or unconnected, $V_{COM_} = 0V$, V_{CC} , or unconnected		60	140	nA
DYNAMIC						
Turn-On Time (Note 4) (Figure 1)	t_{ON}	$V_{CC} = +2.7V$, $V_{NC_}$ or $V_{NO_} = +1.5V$, $R_L = 50\Omega$, $C_L = 35pF$ (MAX4991/MAX4993)	120	360	630	ms
		$V_{CC} = +2.7V$, $V_{NC_}$ or $V_{NO_} = +1.5V$, $R_L = 50\Omega$, $C_L = 35pF$ (MAX4992/MAX4994)		20	150	μs
Turn-Off Time	t_{OFF}	$V_{CC} = +2.7V$, $V_{NC_}$ or $V_{NO_} = +1.5V$, $R_L = 50\Omega$, $C_L = 35pF$, Figure 1 (Note 4)		0.5	2	μs
Off-Isolation	V_{ISO}	$R_S = R_L = 50\Omega$, $f = 20kHz$, $V_{COM_} = 1VP-P$, Figure 2 (Note 5)		-90		dB
Crosstalk	V_{CT}	$R_S = R_L = 50\Omega$, $f = 20kHz$, $V_{COM_} = 1VP-P$, Figure 2 (Note 6)		-110		dB
Total Harmonic Distortion	THD+N	$f = 20Hz$ to $20kHz$, $V_{COM_} = 0.5VP-P$, $R_S = R_L = 50\Omega$, DC bias = $0V$		0.004		%
NC_, NO_ Off-Capacitance	C_{OFF}	$COM_ = GND$ (DC bias), $f = 1MHz$, $V_{NO(NC)} = 100mVP-P$, (Figure 3)		45		pF
COM_ On-Capacitance	C_{ON}	$COM_ = GND$ (DC bias), $f = 1MHz$, $V_{COM} = 100mVP-P$ (Figure 3)		65		pF
DIGITAL I/O (CB, CB1, CB2, EN)						
Input Logic-High	V_{IH}		1.4			V
Input Logic-Low	V_{IL}				0.5	V
Input Leakage Current	I_{CB}	$V_{CB_} = V_{EN} = 0V$ or V_{CC}	-1		+1	μA

Note 2: All devices are 100% production tested at $T_A = +25^{\circ}C$. All temperature limits are guaranteed by design.

Note 3: Flatness is defined as the difference between the maximum and minimum values of on-resistance as measured over the specified analog ranges.

Note 4: All timing is measured using 10% and 90% levels.

Note 5: Off-isolation = $20\log [V_{COM_}/(V_{NO_}$ or $V_{NC_})]$, $V_{COM_}$ = output, $V_{NO_}$ or $V_{NC_}$ = input to off switch.

Note 6: Between any two switches.

Low Ron, Dual-SPDT/Single-DPDT Analog Switches with Slow Turn-On Time

Typical Operating Characteristics

($V_{CC} = +3.0V$, $T_A = +25^\circ C$, unless otherwise noted.)

MAX4991-MAX4994

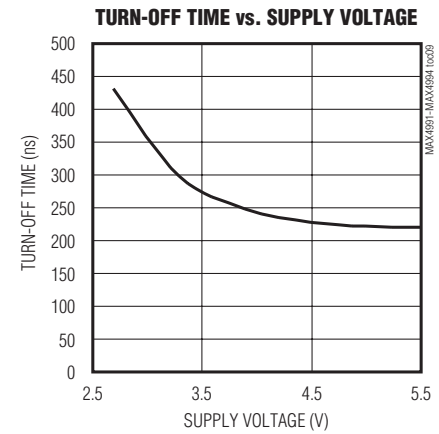
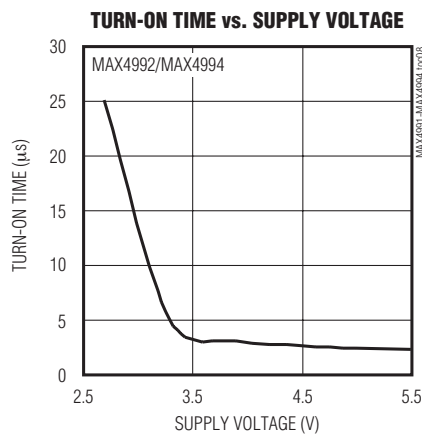
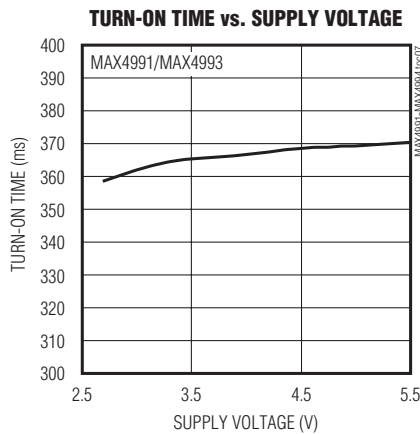
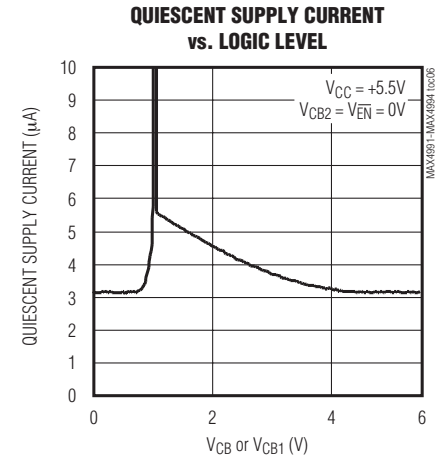
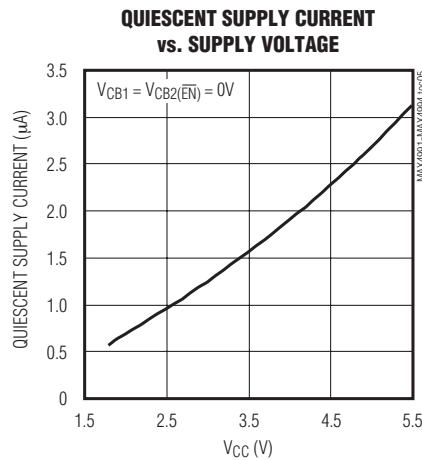
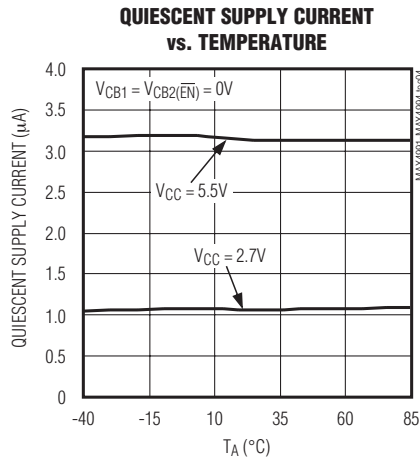
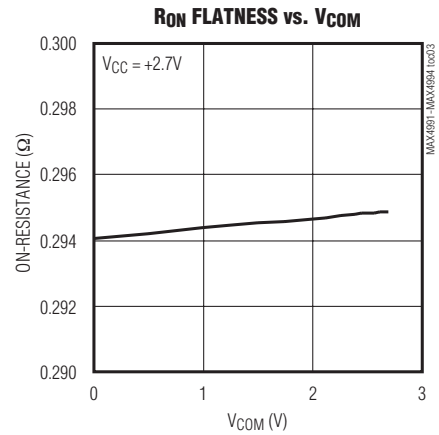
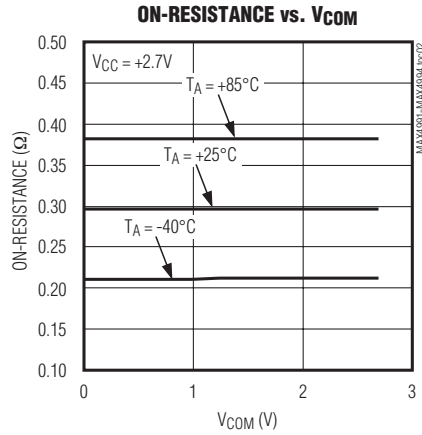
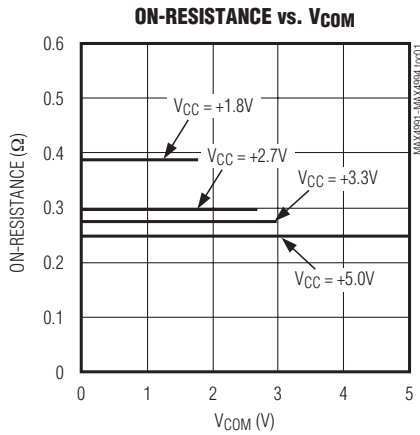

Low Ron, Dual-SPDT/Single-DPDT Analog Switches with Slow Turn-On Time

Typical Operating Characteristics (continued)

($V_{CC} = +3.0V$, $T_A = +25^\circ C$, unless otherwise noted.)

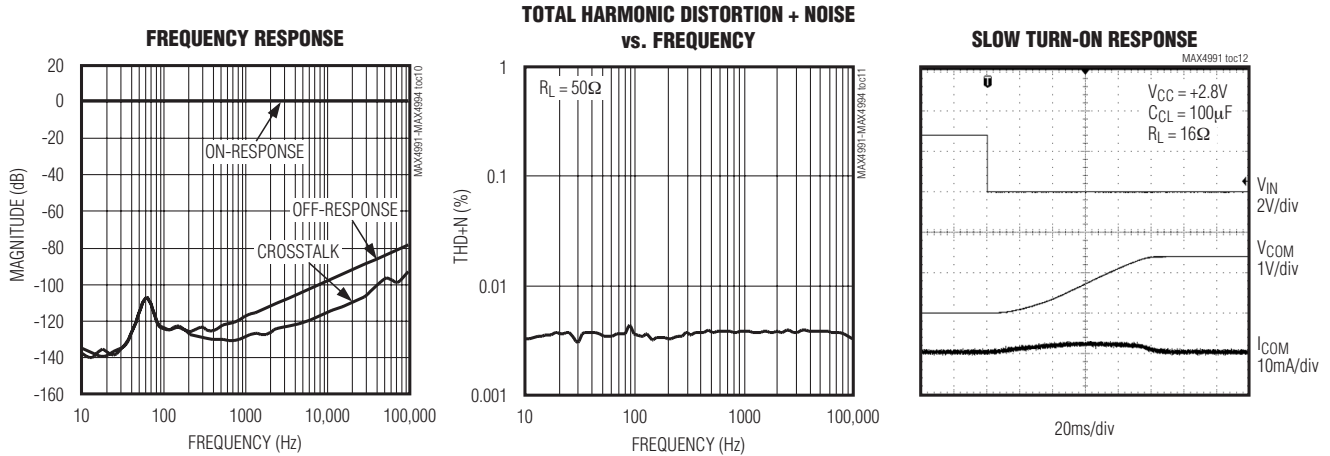

Pin Description

PIN		NAME	FUNCTION
MAX4991/MAX4992	MAX4993/MAX4994		
1	1	V_{CC}	Positive-Supply Voltage Input. Bypass V_{CC} to GND with a $0.1\mu F$ capacitor as close as possible to the device.
2	2	NO1	Analog Switch 1—Normally Open Terminal
3	3	COM1	Analog Switch 1—Common Terminal. COM1 must be connected to the speaker load for click-and-pop reduction.
4	—	CB1	Digital Control Input for Switch 1
—	4	CB	Digital Control Input for Switch 1 and Switch 2
5	5	NC1	Analog Switch 1—Normally Closed Terminal
6	6	GND	Ground
7	7	NC2	Analog Switch 2—Normally Closed Terminal
8	—	CB2	Digital Control Input for Switch 2
—	8	\overline{EN}	Active-Low Enable Input—Drive \overline{EN} high to put switches in high impedance. Drive \overline{EN} low for normal operation.
9	9	COM2	Analog Switch 2—Common Terminal. COM2 must be connected to the speaker load for click-and-pop reduction.
10	10	NO2	Analog Switch 2—Normally Open Terminal

Low Ron, Dual-SPDT/Single-DPDT Analog Switches with Slow Turn-On Time

Functional Diagram

MAX4991-MAX4994

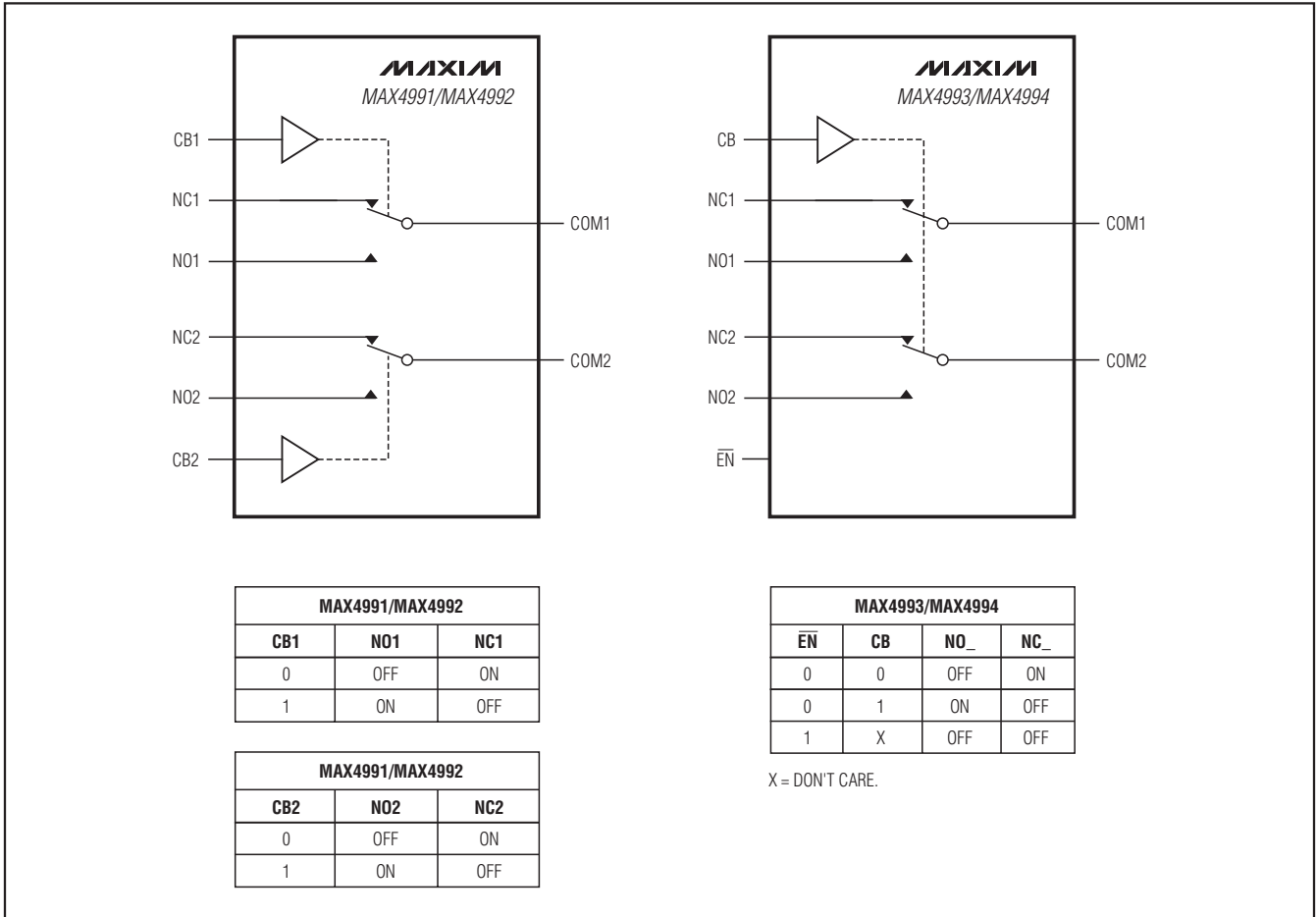

Detailed Description

The MAX4991-MAX4994 low 0.3Ω (typ) on-resistance analog switches have break-before-make switching and operate from a single +1.8V to +5.5V supply. The MAX4991/MAX4993 provide a slow turn-on time, and with COM_ used as the output, reduce clicks and pops due to coupling capacitors and audio amplifiers with a DC output bias. This feature is important for existing architectures with coupling capacitors at the output that need click-and-pop reduction.

The MAX4993/MAX4994 DPDT switches with an active-low enable input (\overline{EN}) set all channels to high impedance and reduce supply current when driven high. The MAX4991-MAX4994 have a low 0.004% THD+N to route high-fidelity audio signals.

Digital Control Input

The MAX4991/MAX4992 have two digital control logic inputs, CB1 and CB2. The MAX4993/MAX4994 have a single digital-control logic input, CB. The digital control logic inputs control the position of the corresponding switch as shown in the *Functional Diagram*. Driving logic inputs rail-to-rail minimizes power consumption.

Enable Input (MAX4993/MAX4994)

The MAX4993/MAX4994 feature an active-low enable input (\overline{EN}). When \overline{EN} is driven high, the switches are high impedance and reduce supply current. When \overline{EN} is driven low, the MAX4993/MAX4994 operate in normal mode. Driving \overline{EN} rail-to-rail minimizes power consumption.

Low RON, Dual-SPDT/Single-DPDT Analog Switches with Slow Turn-On Time

Analog Signal Levels

The MAX4991–MAX4994 have a very low and stable R_{ON} , 0.3Ω (typ), as the analog input signals are swept from ground to V_{CC} (see *Typical Operating Characteristics*). These switches are bidirectional, allowing NO_+ , NC_+ , and COM_+ to be configured as either inputs or outputs; however, click-and-pop reduction is only operational when COM_+ is used as the output.

Power-Supply Rejection Ratio

PSRR is the measurement of AC power-supply ripple or noise that couples to the output. Variations in supply voltage corrupt the audio signal due to changes in the R_{ON} value by supply modulation. The MAX4991–MAX4994 maintain a 80dB (typ) PSRR across the supply-voltage range, eliminating any corruption of the audio signal from supply variations. Therefore, with no audio signal, the R_{ON} variation due to supply-voltage ripple does not contribute to any output signal modulation.

Applications Information

Click-Pop Reduction

The MAX4991/MAX4993 feature a slow switch turn-on that can reduce click-and-pop noise caused by abrupt changes in voltage across a speaker. These voltage

changes usually occur when a single-supply audio amplifier with a DC bias is turned on, causing a spike of current in the speaker while the coupling capacitor charges (see the *Typical Operating Circuit*). If the audio amplifier connected to the unused input is powered up before the switch position changes, the MAX4991/MAX4993 reduce the current spike to COM_+ . The speaker load must be present so that the current charging the coupling capacitor has a path to ground.

Layout

Good layout improves performance by decreasing the amount of stray capacitance and noise. Minimize PCB trace lengths and resistor leads and place external components as close as possible to the device.

Power-Supply Sequencing

Caution: Do not exceed the absolute maximum ratings because stresses beyond the listed ratings may cause permanent damage to the device.

Proper power-supply sequencing is recommended for all devices. Always apply V_{CC} before applying analog signals especially if the analog signal is not current limited.

Low Ron, Dual-SPDT/Single-DPDT Analog Switches with Slow Turn-On Time

Typical Application Circuit

MAX4991-MAX4994

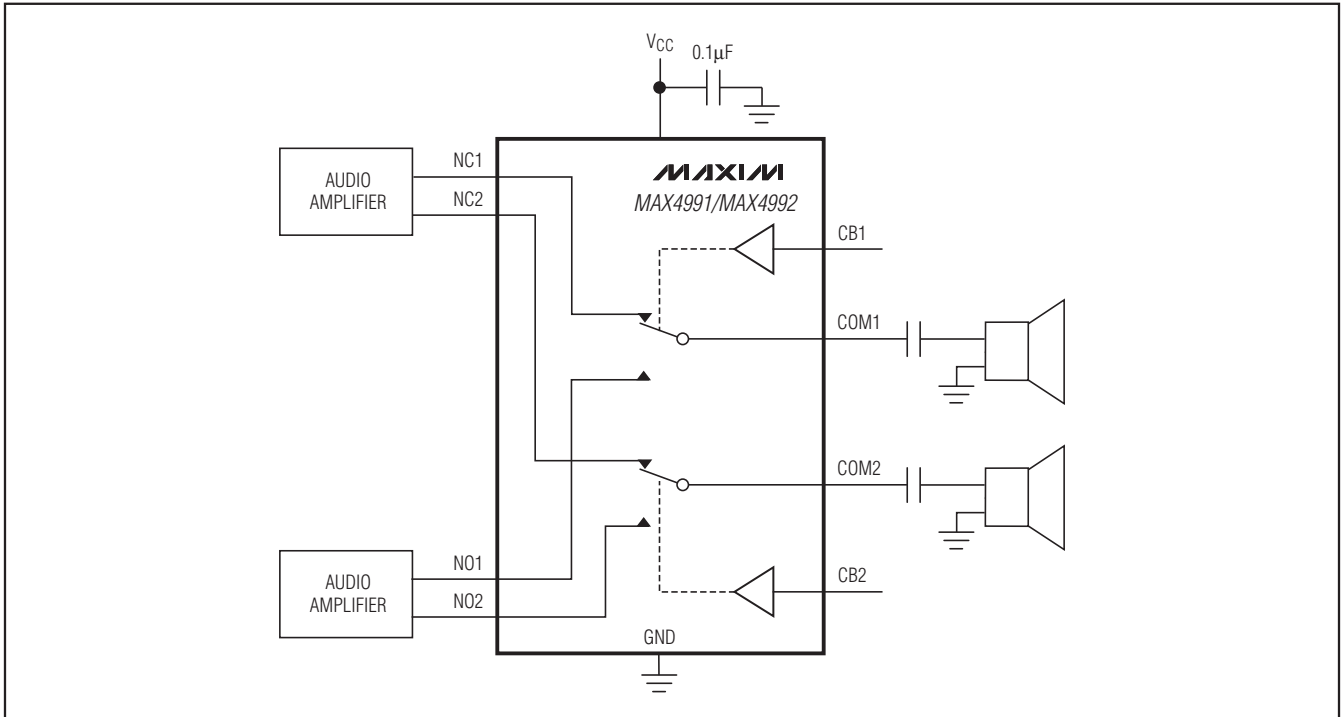

Chip Information

PROCESS: BiCMOS

Package Information

For the latest package outline information and land patterns, go to www.maxim-ic.com/packages.

PACKAGE TYPE	PACKAGE CODE	DOCUMENT NO.
10 UTQFN	V101AICN-1	21-0028

Low Ron, Dual-SPDT/Single-DPDT Analog Switches with Slow Turn-On Time

Revision History

REVISION NUMBER	REVISION DATE	DESCRIPTION	PAGES CHANGED
0	5/08	Initial release.	—
1	6/09	<ul style="list-style-type: none">• Corrected names of power pins (added subscripting) in <i>Electrical Characteristics</i>.• Changed the name of <i>TOC 10</i> to "Frequency Response."• Added units of measure to <i>TOC 12</i>.	2, 6

Maxim cannot assume responsibility for use of any circuitry other than circuitry entirely embodied in a Maxim product. No circuit patent licenses are implied. Maxim reserves the right to change the circuitry and specifications without notice at any time.

10 _____ **Maxim Integrated Products, 120 San Gabriel Drive, Sunnyvale, CA 94086 408-737-7600**

Looking for pricing, stock, or lifecycle information?

Click below to explore more details on WIN SOURCE:

 [View MAX4993EVB+ on WIN SOURCE](#)

 [Maxim Integrated](#) Information

Optimize Your Supply Chain with WIN SOURCE Solutions

-  Global Sourcing Solution
-  Obsolete Management
-  Cost Control Management
-  Shortage Management
-  Alternative Solution
-  Excess Inventory Management