



**THE DATASHEET OF  
MAX6611AUT+T**





# Precision, Low-Power, 6-Pin SOT23 Temperature Sensors and Voltage References

## General Description

The MAX6610/MAX6611 are precise, low-power analog temperature sensors combined with a precision voltage reference. They are ideal for applications involving analog-to-digital converters (ADCs), where the MAX6610/MAX6611 provide the reference voltage for the ADC and develop a temperature output voltage that is scaled to provide convenient ADC output codes. An 8-bit ADC's LSB is equal to 1°C, while a 10-bit ADC's LSB corresponds to 0.25°C.

The MAX6610/MAX6611 are available in two versions. The MAX6611 operates from a 4.5V to 5.5V power supply and has a 4.096V reference output. The MAX6610 operates from 3.0V to 5.5V and has a 2.560V reference output. Power-supply current is less than 150µA (typ). Both the MAX6610/MAX6611 are available in a 6-pin SOT23 package and operate from -40°C to +125°C.

## Applications

System Temperature Monitoring  
Temperature Compensation  
HVAC  
Home Appliances

## Pin Configuration

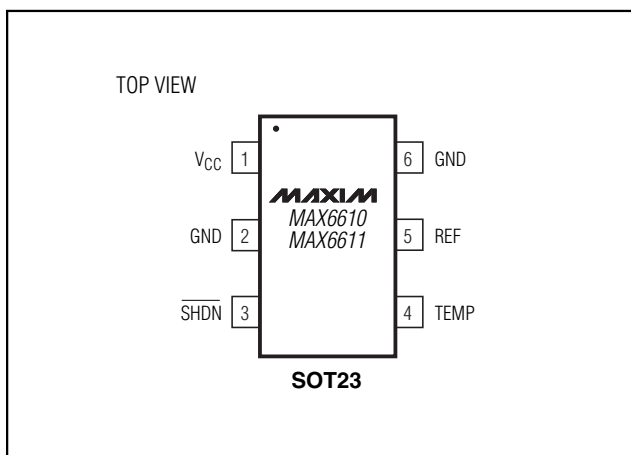

## Features

- ◆ ±1°C Accuracy
- ◆ Low TC Reference (±10ppm, typ)
- ◆ Temperature Output Scaled for ADCs
- ◆ Integrated Reference Voltage Scaled for Convenient ADC Bit Weights
- ◆ No Calibration Required
- ◆ Low Supply Current
- ◆ Tiny 6-Pin SOT23 Package
- ◆ Low-Current Shutdown Mode

## Ordering Information

PART	TEMP RANGE	PIN-PACKAGE	VREF (V)	TOP MARK
MAX6610AUT-T	-40°C to +125°C	6 SOT23-6	2.560	ABDO
MAX6611AUT-T	-40°C to +125°C	6 SOT23-6	4.096	ABOP

## Typical Application Circuit

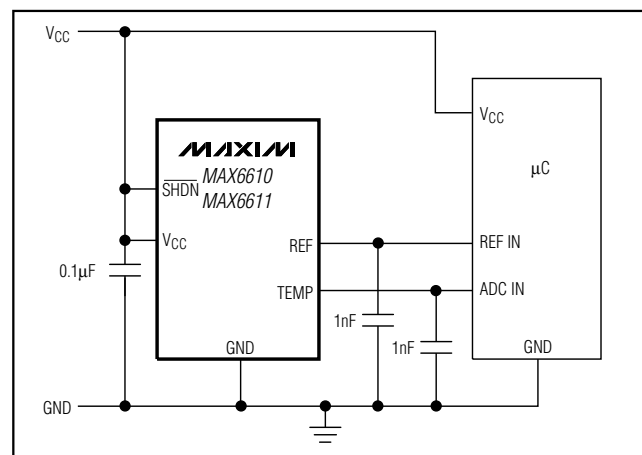

# Precision, Low-Power, 6-Pin SOT23 Temperature Sensors and Voltage References

## ABSOLUTE MAXIMUM RATINGS

Voltages Referenced to GND

V <sub>CC</sub> .....	-0.3V to +6.0V
All Other Pins .....	-0.3V to (V <sub>CC</sub> + 0.3V)
Input Current .....	20mA
Output Current .....	20mA
Continuous Power Dissipation (T <sub>A</sub> = +70°C) 6-Pin SOT23 (derate 8.7mW/°C above +70°C) .....	695.7mW

Operating Temperature Range (T<sub>MIN</sub>, T<sub>MAX</sub>) ....-40°C to +125°C

ESD Protection (all pins, Human Body Model) .....2000V

Storage Temperature Range .....-65°C to +150°C

Junction Temperature .....+150°C

Lead Temperature (soldering, 10s) .....+300°C

Stresses beyond those listed under "Absolute Maximum Ratings" may cause permanent damage to the device. These are stress ratings only, and functional operation of the device at these or any other conditions beyond those indicated in the operational sections of the specifications is not implied. Exposure to absolute maximum rating conditions for extended periods may affect device reliability.

## ELECTRICAL CHARACTERISTICS

(V<sub>CC</sub> = 3.0 to 5.5V (MAX6610), V<sub>CC</sub> = 4.5V to 5.5V (MAX6611), T<sub>A</sub> = T<sub>MIN</sub> to T<sub>MAX</sub>, unless otherwise noted. Typical values are at V<sub>CC</sub> = 5.0V (MAX6611) and V<sub>CC</sub> = 3.3V (MAX6610), T<sub>A</sub> = +25°C.) (Note 1)

PARAMETER	SYMBOL	CONDITIONS	MIN	TYP	MAX	UNITS
Supply Current	I <sub>CC</sub>	Outputs unloaded		150	250	μA
		SHDN = 0		0.2	1	
Temperature Sensor Error		T <sub>A</sub> = +25°C	-1.2		+1.2	°C
		T <sub>A</sub> = -10°C to +55°C (Note 2)	-2.4		+2.4	
		T <sub>A</sub> = -20°C to +85°C (Note 2)	-3.7		+3.7	
		T <sub>A</sub> = -40°C to +125°C (Note 2)	-5.0		+5.0	
Temperature Sensor Output Voltage	V <sub>TEMP</sub>	MAX6611, T <sub>A</sub> = 0°C		1.200		V
		MAX6610, T <sub>A</sub> = 0°C		0.750		
Temperature Sensor Nonlinearity		T <sub>A</sub> = -10°C to +80°C		1		°C
Temperature Sensor Output Slope		MAX6611		16		mV/°C
		MAX6610		10		
Temperature Sensor Supply Sensitivity		3.0V ≤ V <sub>CC</sub> ≤ 5.5V for MAX6610 and 4.5V ≤ V <sub>CC</sub> ≤ 5.5V for MAX6611			0.5	°C/V
Temperature Sensor Load Regulation		Sourcing: 0 ≤ I <sub>OUT</sub> ≤ 500μA	-1	-2.5	+1	°C/mA
		Sinking: -100μA ≤ I <sub>OUT</sub> ≤ 0	-2.5		+5	
Temperature Sensor Capacitive Load		No sustained oscillations (Note 3)	0		0.2	μF
Temperature Sensor Long-Term Stability		T <sub>A</sub> = +50°C for 1000hr		±0.1		°C
Reference Output Voltage	V <sub>REF</sub>	MAX6611, T <sub>A</sub> = +25°C	4.076	4.096	4.116	V
		MAX6610, T <sub>A</sub> = +25°C	2.547	2.560	2.573	
Voltage Reference Temperature Coefficient		T <sub>A</sub> = -40°C to +85°C	-50	±10	+50	ppm/°C
Voltage Reference Line Regulation			-1		+1	mV/V
Voltage Reference Load Regulation	ΔV <sub>OUT</sub> /ΔI <sub>OUT</sub>	Sourcing: 0 ≤ I <sub>OUT</sub> ≤ 1mA		1	2	Ω
		Sinking: -200μA ≤ I <sub>OUT</sub> ≤ 0		4	20	
Voltage Reference Long-Term Stability	ΔV <sub>OUT</sub> /time	1000h at T <sub>A</sub> = +25°C		50		ppm

# Precision, Low-Power, 6-Pin SOT23 Temperature Sensors and Voltage References

MAX6610/MAX6611

## ELECTRICAL CHARACTERISTICS (continued)

( $V_{CC} = 3.0$  to  $5.5$  V (MAX6610),  $V_{CC} = 4.5$  V to  $5.5$  V (MAX6611),  $T_A = T_{MIN}$  to  $T_{MAX}$ , unless otherwise noted. Typical values are at  $V_{CC} = 5.0$  V (MAX6611) and  $V_{CC} = 3.3$  V (MAX6610),  $T_A = +25^\circ\text{C}$ .) (Note 1)

PARAMETER	SYMBOL	CONDITIONS	MIN	TYP	MAX	UNITS
Voltage Reference Output Noise		$f = 0.1\text{Hz to }10\text{Hz}$		100		$\mu\text{VP-P}$
		$f = 10\text{Hz to }10\text{kHz}$		100		$\mu\text{VP-P}$
Turn-On Settling Time ( $V_{CC}$ to REF)		$V_{CC} = 0$ to $5\text{V}$ step, $C_{LOAD} = 50\text{pF}$ , $V_{REF} = 0.1\%$ of final value		300		$\mu\text{s}$
Turn-On Settling Time ( $V_{CC}$ to TEMP)		$V_{CC} = 0$ to $5\text{V}$ step, $C_{LOAD} = 50\text{pF}$ , $V_{TEMP} = 1^\circ\text{C}$ of final value		500		$\mu\text{s}$
Turn-On Settling Time ( $\overline{\text{SHDN}}$ to REF)		$\overline{\text{SHDN}} = 0$ to $5\text{V}$ step, $C_{LOAD} = 50\text{pF}$ , $V_{REF} = 0.1\%$ of final value		300		$\mu\text{s}$
Turn-On Settling Time ( $\overline{\text{SHDN}}$ to TEMP)		$\overline{\text{SHDN}} = 0$ to $5\text{V}$ step, $C_{LOAD} = 50\text{pF}$ , $V_{TEMP} = 1^\circ\text{C}$ of final value		500		$\mu\text{s}$
<b>LOGIC INPUT (<math>\overline{\text{SHDN}}</math>)</b>						
Logic Input High Voltage	$V_{IH}$		$V_{CC} - 0.5$			V
Logic Input Low Voltage	$V_{IL}$				0.5	V
Logic Input Leakage	$I_{LEAK}$	$\overline{\text{SHDN}} = 5\text{V}$ , $V_{CC} = 5\text{V}$		10	25	$\mu\text{A}$
		$\overline{\text{SHDN}} = 0\text{V}$ , $V_{CC} = 5\text{V}$		0.1	1	

**Note 1:** All parameters tested at room temperature. Values through temperature are guaranteed by design.

**Note 2:** Guaranteed to 4 sigma.

**Note 3:** Guaranteed by design.

## Typical Operating Characteristics

( $V_{CC} = 5\text{V}$ ,  $I_{OUT} = 0\text{V}$ ,  $T_A = +25^\circ\text{C}$ , unless otherwise specified.)

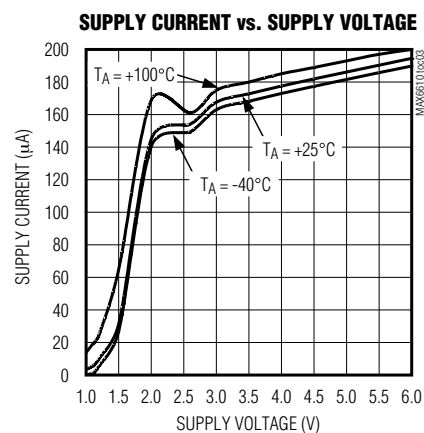
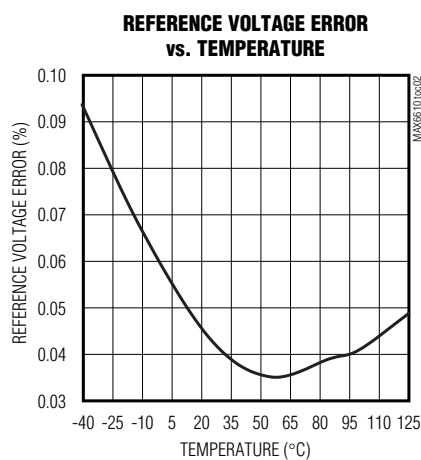
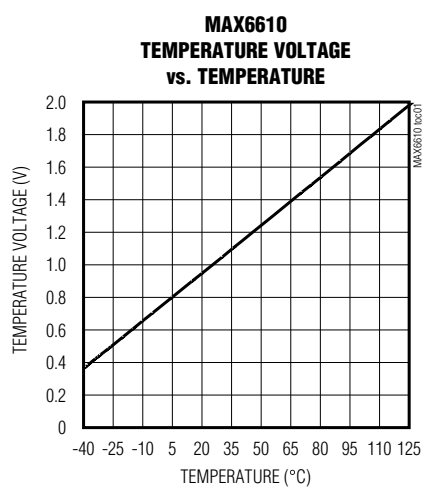

# Precision, Low-Power, 6-Pin SOT23 Temperature Sensors and Voltage References

## Pin Description

PIN	NAME	FUNCTION
1	VCC	Supply Voltage Input. Bypass to GND with a 0.1μF capacitor.
2	GND	Ground
3	$\overline{\text{SHDN}}$	Logic Level Shutdown Input (Active Low). Driving $\overline{\text{SHDN}}$ with a logic low turns off internal circuitry to reduce supply current to 1μA (max).
4	TEMP	Temperature Output Pin. Voltage at TEMP varies linearly with temperature.
5	REF	Reference Voltage Output
6	GND	Must be connected to pin 2.

## Detailed Description

The MAX6610/MAX6611 combine a temperature sensor with a low-power voltage reference. The reference voltage and temperature sensor gain give convenient LSB weights when used with an ADC.

For example, when an 8-bit ADC is used with the MAX6610/MAX6611, an LSB is equivalent to 1°C and a 10-bit ADC LSB is equivalent to 0.25°C.

The reference output features a proprietary temperature-coefficient, curvature-correction circuit and laser-trimmed thin-film resistors that result in a low temperature coefficient (50ppm/°C max) and initial accuracy of ±0.5% max. The maximum supply current is 250μA during normal operation and 1μA max during shutdown. The supply voltage range is 3.0V to 5.5V for the MAX6610 and 4.5V to 5.5V for the MAX6611.

### Voltage Reference

The MAX6610/MAX6611 REF output provides a voltage reference for ADCs or other system subcircuits. REF is capable of driving loads of up to 1mA. An output capacitor can be as large as 1μF.

The voltage reference provides scaled ADC conversions with bit weights that are in convenient units.

For the MAX6610 (2.56V REF output), an 8-bit ADC yields 10mV/bit or 2.5mV/bit for a 10-bit ADC. The MAX6611 (4.096V REF output) yields 16mV/bit for an 8-bit ADC or 4mV/bit for a 10-bit ADC.

## Temperature Sensor

The MAX6610/MAX6611 TEMP output provides an analog output voltage that is a linear function of its die temperature as defined by:

$V_{\text{TEMP}} = 1.2\text{V} + (T^{\circ}\text{C} \times 16\text{mV}/^{\circ}\text{C})$  for the MAX6611 and

$V_{\text{TEMP}} = 0.75\text{V} + (T^{\circ}\text{C} \times 10\text{mV}/^{\circ}\text{C})$  for the MAX6610

The slope of the output voltage is  $V_{\text{REF}}/256$  per °C (16mV/°C for the MAX6611 and 10mV/°C for the MAX6610). There is a +75°C offset on the temperature output (The MAX6611's output is 1.2V and, the MAX6610's output is 0.75V) at 0°C. The temperature error is less than 1.2°C at  $T_A = +25^{\circ}\text{C}$ , less than ±3.8°C from  $T_A = -20^{\circ}\text{C}$  to +85°C, and only ±5°C for  $T_A = -40^{\circ}\text{C}$  to +125°C.

## Shutdown

The MAX6610/MAX6611 are equipped with a shutdown feature that, when driven low, shuts down all internal circuitry and reduces supply current to 1μA (max). When in shutdown, REF is pulled to GND through a 150kΩ resistor and TEMP goes to a high-impedance state. For normal operation, connect  $\overline{\text{SHDN}}$  to VCC.

## Applications Information

### Output/Load Capacitance

The MAX6610/MAX6611 TEMP output can drive capacitive loads up to 0.2μF. The MAX6610/MAX6611 REF output can drive capacitive loads up to 1μF. Devices in this family do not require an output capacitance for dynamic stability. However, in applications where the load or the supply can experience step changes, an output capacitor within the specified range reduces the amount of overshoot (or undershoot) and assists the circuit's transient response. Many applications do not need an external capacitor, and this family can offer a significant advantage in these applications when board space is critical.

### Supply Current

The quiescent supply current of the MAX6610/MAX6611 is typically 150μA and is virtually independent of the supply voltage. Unlike shunt-mode references, the load current of series-mode references is drawn from the supply voltage only when required, so supply current is not wasted and efficiency is maximized over the entire supply voltage range. This improved efficiency can help reduce power dissipation and extend battery life.

# Precision, Low-Power, 6-Pin SOT23 Temperature Sensors and Voltage References

## **Sensing Circuit Board and Ambient Temperatures**

Temperature sensor ICs, like the MAX6610/MAX6611 that sense their own die temperatures, must be mounted on, or close to, the object whose temperature they are intended to measure. Because there is a good thermal path between the package's metal leads and the IC die, the MAX6610/MAX6611 can accurately measure the temperature of the circuit board to which it is soldered. If the sensor is intended to measure the temperature of a heat-generating component on the circuit board, it should be mounted as close as possible to that component and should share supply and ground traces (if they are not noisy) with that component where possible. This maximizes the heat transfer from the component to the sensor. The thermal path between the plastic package and the die is not as good as the path through the leads, so the MAX6610/MAX6611, like all temperature sensors in plastic packages, are less sensitive to the temperature of the surrounding air than to the temperature of the leads. They can be successfully used to sense ambient temperature if the circuit board is designed to track the ambient temperature.

As with any IC, the wiring and circuits must be kept insulated and dry to avoid leakage and corrosion, especially if the part is operated at cold temperatures where condensation can occur.

## **Self-Heating**

The MAX6610/MAX6611 are low-power circuits and are intended to drive light loads. As a result, the temperature rise due to power dissipation on the die is insignificant under normal conditions.

For example, assume that the MAX6611 is operating from a 5V supply at +50°C ( $V_{TEMP} = 2V$ ) and that the temperature output is driving a 100k $\Omega$  load ( $I_{TEMP} = 20\mu A$ ). Also assume that the voltage reference is driving a 500 $\mu A$  load and the worst-case quiescent supply current is used. In the 6-pin SOT23 package, the die temperature increases above the ambient by 0.2°C.

Next, assume TEMP and REF are driving their maximum loads ( $I_{TEMP} = 500\mu A$  and  $I_{REF} = 1mA$ ) and  $V_{CC} = 5V$ , and  $T_A = +50^\circ C$  ( $V_{TEMP} = 2V$ ). Here, the die temperature increases above the ambient by 0.4°C.

A first order for self-heating effects can be estimated from temperature and reference load currents and the previous supply voltage.

## **Chip Information**

TRANSISTOR COUNT: 1346

PROCESS: BiCMOS

MAX6610/MAX6611

# Precision, Low-Power, 6-Pin SOT23 Temperature Sensors and Voltage References

## Package Information

(The package drawing(s) in this data sheet may not reflect the most current specifications. For the latest package outline information, go to [www.maxim-ic.com/packages](http://www.maxim-ic.com/packages).)

SYMBOL	MIN	MAX
A	0.90	1.45
A1	0.00	0.15
A2	0.90	1.30
b	0.35	0.50
C	0.08	0.20
D	2.80	3.00
E	2.60	3.00
E1	1.50	1.75
L	0.35	0.60
L1	0.60 REF.	
e1	1.90 BSC.	
e	0.95 BSC.	
alpha	0°	10°

NOTES:  
 1. ALL DIMENSIONS ARE IN MILLIMETERS.  
 2. FOOT LENGTH MEASURED AT INTERCEPT POINT BETWEEN DATUM A & LEAD SURFACE.  
 3. PACKAGE OUTLINE EXCLUSIVE OF MOLD FLASH & METAL BURR. MOLD FLASH, PROTRUSION OR METAL BURR SHOULD NOT EXCEED 0.25 MM.  
 4. PACKAGE OUTLINE INCLUSIVE OF SOLDER PLATING.  
 5. PIN 1 IS LOWER LEFT PIN WHEN READING TOP MARK FROM LEFT TO RIGHT. (SEE EXAMPLE TOP MARK)  
 6. PIN 1 I.D. DOT IS 0.3 MM Ø MIN. LOCATED ABOVE PIN 1.  
 7. MEETS JEDEC MO178, VARIATION AB.  
 8. SOLDER THICKNESS MEASURED AT FLAT SECTION OF LEAD BETWEEN 0.08mm AND 0.15mm FROM LEAD TIP.  
 9. LEAD TO BE COPLANAR WITHIN 0.1 MM.

DALLAS SEMICONDUCTOR **MAXIM**  
 PROPRIETARY INFORMATION  
 TITLE: PACKAGE OUTLINE, SOT-23, 6L  
 APPROVAL: \_\_\_\_\_ DOCUMENT CONTROL NO. 21-0058 REV. F 1/1



6LSOT.EPS

Maxim cannot assume responsibility for use of any circuitry other than circuitry entirely embodied in a Maxim product. No circuit patent licenses are implied. Maxim reserves the right to change the circuitry and specifications without notice at any time.

6 Maxim Integrated Products, 120 San Gabriel Drive, Sunnyvale, CA 94086 408-737-7600

## Looking for pricing, stock, or lifecycle information?

Click below to explore more details on WIN SOURCE:

-  [View MAX6611AUT+T on WIN SOURCE](#)
-  [Maxim Integrated Information](#)

## Optimize Your Supply Chain with WIN SOURCE Solutions

-  Global Sourcing Solution
-  Obsolete Management
-  Cost Control Management
-  Shortage Management
-  Alternative Solution
-  Excess Inventory Management