



**THE DATASHEET OF
MAX6661AEE+**





Remote Temperature-Controlled Fan-Speed Regulator with SPI-Compatible Interface

General Description

The MAX6661 is a remote temperature sensor and fan-speed regulator that provides complete closed-loop fan control. The remote temperature sensor is typically a common-collector PNP, such as a substrate PNP of a microprocessor, or a diode-connected transistor, typically a low-cost, easily mounted 2N3904 NPN type or 2N3906 PNP type.

The device also incorporates a closed-loop fan controller that regulates fan speed with tachometer feedback. The MAX6661 compares temperature data to a fan threshold temperature and gain setting, both programmed over the SPI™ bus by the user. The result is automatic fan control that is proportional to the remote-junction temperature. The temperature feedback loop can be broken at any time for system control over the speed of the fan.

Fan speed is voltage controlled as opposed to PWM controlled, greatly reducing acoustic noise and maximizing fan reliability. An on-chip power device drives fans rated up to 250mA.

Temperature data is updated every 500ms and is readable at any time over the SPI interface. The MAX6661 is accurate to 1°C (max) when the remote junction is between +60°C to +100°C. Data is formatted as a 10-bit + sign word with 0.125°C resolution.

The MAX6661 is specified between -40°C to +125°C and is available in a 16-pin QSOP package.

Applications

Telecom Systems
Servers
Workstations
Electronic Instruments

Pin Configuration appears at end of data sheet.

SPI is a trademark of Motorola, Inc.

Features

- ◆ Integrated Thermal Measurement and Fan Regulation
- ◆ Programmable Fan Threshold Temperature
- ◆ Programmable Temperature Range for Full-Scale Fan Speed
- ◆ Accurate Closed-Loop Fan-Speed Regulation
- ◆ On-Chip Power Device Drives Fans Rated Up to 250mA
- ◆ Programmable Under/Overtemperature Alarms
- ◆ SPI-Compatible Serial Interface
- ◆ ±1°C (+60°C to +100°C) Thermal-Sensing Accuracy

Ordering Information

PART	TEMP RANGE	PIN-PACKAGE
MAX6661AEE	-40°C to +125°C	16 QSOP

Typical Operating Circuit

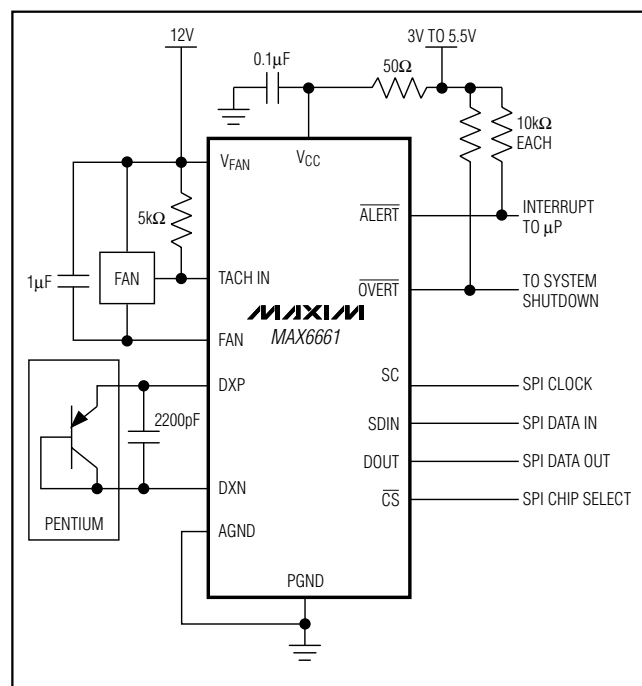

Remote Temperature-Controlled Fan-Speed Regulator with SPI-Compatible Interface

ABSOLUTE MAXIMUM RATINGS

V_{CC} , \overline{ALERT} , \overline{OVERT}	-0.3V to +6V
V_{FAN} , TACH IN, FAN	-0.3V to +16V
DXN, \overline{CS} , SDOOUT, GAIN, SCL, SDIN	-0.3V to (V_{CC} + 0.3V)
DXN	-0.3V to +1V
SDOOUT Current	-1mA to +50mA
DXN Current	± 1 mA
FAN Out Current	500mA

Continuous Power Dissipation ($T_A = +70^\circ\text{C}$)	
16-Pin QSOP (derate 8.3mW/ $^\circ\text{C}$ above $+70^\circ\text{C}$)	667mW
Operating Temperature Range	-40°C to $+125^\circ\text{C}$
Junction Temperature	$+150^\circ\text{C}$
Storage Temperature Range	-65°C to $+150^\circ\text{C}$
Lead Temperature (soldering, 10s)	$+300^\circ\text{C}$

Stresses beyond those listed under "Absolute Maximum Ratings" may cause permanent damage to the device. These are stress ratings only, and functional operation of the device at these or any other conditions beyond those indicated in the operational sections of the specifications is not implied. Exposure to absolute maximum rating conditions for extended periods may affect device reliability.

ELECTRICAL CHARACTERISTICS

($V_{CC} = 3\text{V}$ to 5.5V , $V_{FAN} = 12\text{V}$, $T_A = -40^\circ\text{C}$ to $+125^\circ\text{C}$, unless otherwise specified. Typical values are at $V_{CC} = 3.3\text{V}$ and $T_A = +25^\circ\text{C}$.) (Notes 1 and 2)

PARAMETER	SYMBOL	CONDITIONS	MIN	TYP	MAX	UNITS
ADC AND POWER SUPPLY						
Temperature Resolution (Note 3)			0.125			$^\circ\text{C}$
				11		Bits
Remote-Junction Temperature Measurement Error (Note 4)	T_E	$T_A = +85^\circ\text{C}$, $V_{CC} = 3.3\text{V}$	$T_{RJ} = +60^\circ\text{C}$ to $+100^\circ\text{C}$	-1	+1	$^\circ\text{C}$
			$T_{RJ} = +25^\circ\text{C}$ to $+125^\circ\text{C}$	-3	+3	$^\circ\text{C}$
			$T_{RJ} = -40^\circ\text{C}$ to $+125^\circ\text{C}$	-5	+5	$^\circ\text{C}$
Fan-Speed Measurement Accuracy				± 25		%
V_{CC} Supply Voltage Range	V_{CC}		3.0		5.5	V
V_{FAN} Supply Voltage Range	V_{FAN}		4.5		13.5	V
Conversion Time				0.25		s
Conversion Rate Timing Error			-25		+25	%
Undervoltage Lockout (UVLO) Threshold	V_{UVLO}	V_{CC} falling	2.50	2.80	2.95	V
UVLO Threshold Hysteresis	V_{HYST}			90		mV
POR Threshold (V_{CC})		V_{CC} rising	1.4	2.0	2.5	V
POR Threshold Hysteresis				90		mV
Standby Supply Current	I_{SHDN}	Shutdown, configuration bit 6 = 1		3	20	μA
Operating Supply Current	I_{CC}	Fan off		450	700	μA
DXN Source Voltage	V_{DXN}			0.7		V
TACH Input Transition Level		$V_{FAN} = 12\text{V}$		10.5		V
TACH Input Hysteresis		$V_{FAN} = 12\text{V}$		190		mV
TACH Input Resistance				250		$\text{k}\Omega$
Fan Output Current	I_F		250			mA
Fan Output Current Limit	I_L	(Note 5)		320	410	mA
Fan Output On-Resistance	R_{ONF}	250mA load		4		Ω

Remote Temperature-Controlled Fan-Speed Regulator with SPI-Compatible Interface

MAX6661

ELECTRICAL CHARACTERISTICS (continued)

($V_{CC} = 3V$ to $5.5V$, $V_{FAN} = 12V$, $T_A = -40^{\circ}C$ to $+125^{\circ}C$, unless otherwise specified. Typical values are at $V_{CC} = 3.3V$ and $T_A = +25^{\circ}C$.) (Notes 1 and 2)

PARAMETER	SYMBOL	CONDITIONS	MIN	TYP	MAX	UNITS
INTERFACE PINS (SDIN, SC, CS, DOUT, ALERT, OVERT)						
Serial Bus Maximum Clock Frequency (Note 5)	SC				2.5	MHz
Logic Input High Voltage		$V_{CC} = 3V$	2.2			V
		$V_{CC} = 5.5V$	2.4			
Logic Input Low Voltage		$V_{CC} = 3V$ to $5V$			0.8	V
Logic Output High-Voltage DOUT		$V_{CC} = 3V$, $I_{SOURCE} = 6mA$ (Note 5)	$V_{CC} - 0.4V$			V
Logic Output Low-Voltage DOUT		$V_{CC} = 3V$, $I_{SINK} = 6mA$ (Note 5)			0.4	V
Logic Output Low-Voltage ALERT, OVERT		$V_{CC} = 3V$, $I_{SINK} = 6mA$ (Note 5)			0.4	V
ALERT, OVERT Output High Leakage Current		ALERT, OVERT forced to $5.5V$			1	μA
Logic Input Current		Logic inputs forced to V_{CC} or GND	-2		2	μA
SPI AC TIMING (Figure 5)						
CS High to DOUT Three-State	t_{TR}	$C_{LOAD} = 100pF$, $R_{GS} = 10k\Omega$ (Note 5)			200	ns
CS to SC Setup Time	t_{CSS}	(Note 5)	200			ns
SC Fall to DOUT Valid	t_{DO}	$C_{LOAD} = 100pF$			200	ns
DIN to SC Setup Time	t_{DS}		200			ns
DIN to SC Hold Time	t_{DH}	(Note 5)	200			ns
SC Period	t_{CP}		400			ns
SC High Time	t_{CH}		200			ns
SC Low Time	t_{CL}		200			ns
CS High Pulse Width	t_{CSW}	(Note 5)	400			ns
Output Rise Time	t_R	$C_{LOAD} = 100pF$		10		ns
Output Fall Time	t_F	$C_{LOAD} = 100pF$		10		ns
SC Falling Edge to CS Rising	t_{SCS}	(Note 5)	200			ns

Note 1: $T_A = T_J$. This implies zero dissipation in pass transistor (no load, or fan turned off).

Note 2: All parameters are 100% production tested at a single temperature, unless otherwise indicated. Parameter values through temperature are guaranteed by design.

Note 3: The fan control section of the MAX6661 and temperature comparisons use only 9 bits of the 11-bit temperature measurement with a $0.5^{\circ}C$ LSB.

Note 4: Wide-range accuracy is guaranteed by design, not production tested.

Note 5: Guaranteed by design.

Remote Temperature-Controlled Fan-Speed Regulator with SPI-Compatible Interface

Typical Operating Characteristics

($T_A = +25^\circ\text{C}$, unless otherwise noted.)

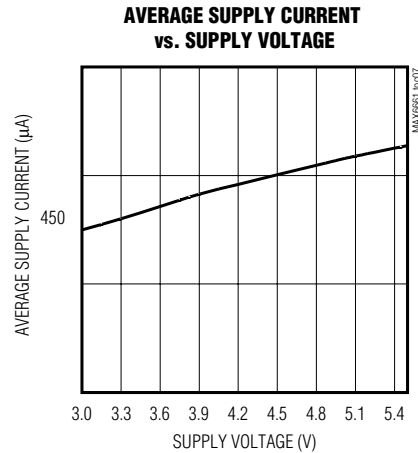
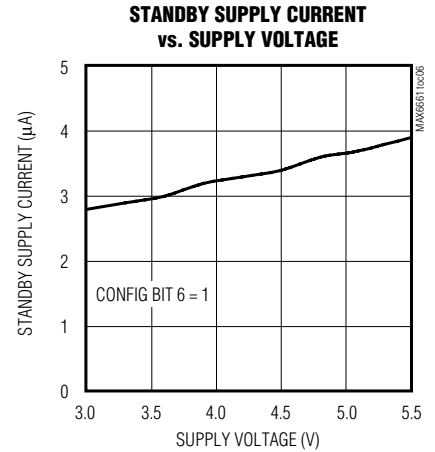
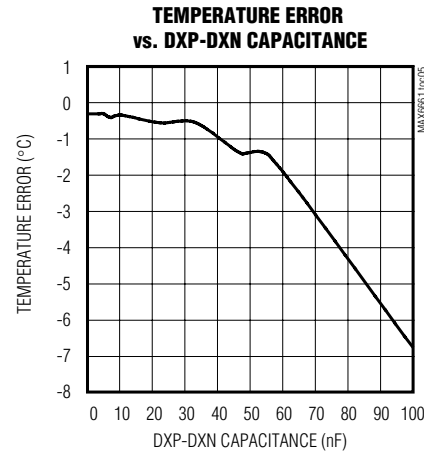
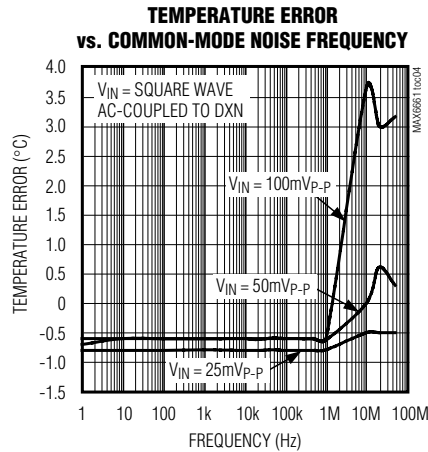
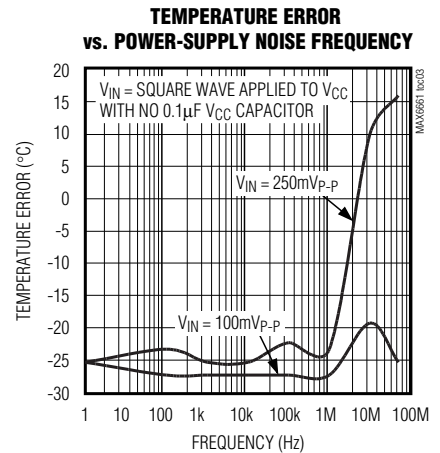
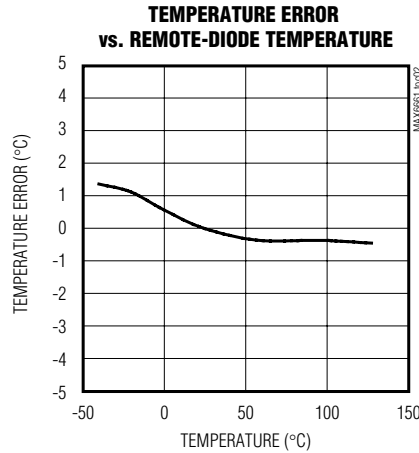
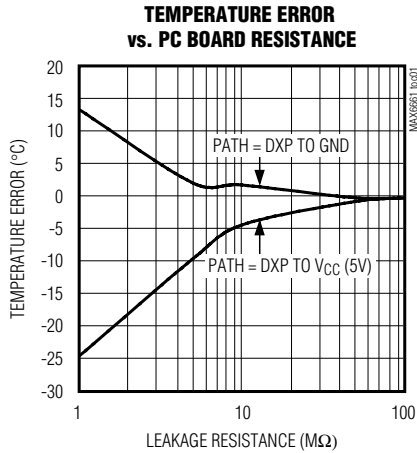

Remote Temperature-Controlled Fan-Speed Regulator with SPI-Compatible Interface

Pin Description

MAX6661

PIN	NAME	FUNCTION
1	V _{FAN}	Power Supply for Fan Drive: 4.5V to 13.5V
2	V _{CC}	Power Supply: 3V to 5.5V. Bypass with a 0.1μF capacitor to GND.
3	DXP	Input: Remote-Junction Anode. Place a 2200pF capacitor between DXP and DXN for noise filtering.
4	DXN	Input: Remote-Junction Cathode. DXN is internally biased to a diode voltage above ground.
5	FAN	Output to Fan Low Side
6	N.C.	No External Connection. Must be left floating.
7	PGND	Power Ground
8	AGND	Analog Ground
9	$\overline{\text{OVERT}}$	Output to System Shutdown. Active-low output, programmable for active high, if desired. Open drain.
10	$\overline{\text{CS}}$	SPI Chip Select. Active low.
11	$\overline{\text{ALERT}}$	Open-Drain Active-Low Output
12	DOUT	SPI Data Output. High-Z when not being read.
13	GAIN	Leave open if tachometer feedback is being used. Connect an external resistor to V _{CC} to reduce the gain of the current sense.
14	SCL	SPI Clock
15	SDIN	SPI Data In
16	TACH IN	Fan Tachometer Input. 13.5V tolerant, pullup from V _{CC} to 13.5V is allowed on this line.

Detailed Description

The MAX6661 is a remote temperature sensor and fan controller with an SPI interface. The MAX6661 converts the temperature of a remote PN junction to a 10-bit + sign digital word. The remote PN junction can be a diode-connected transistor, such as a 2N3906, or the type normally found on the substrate of many processors' ICs. The temperature information is provided to the fan-speed regulator and is read over the SPI interface. The temperature data, through the SPI interface, can be read as a 10-bit + sign two's complement word with a 0.125°C resolution (LSB) and is updated every 0.5s.

The MAX6661 incorporates a closed-loop fan controller that regulates the fan speed with tachometer feedback. The temperature information is compared to a threshold and range setting, which enables the MAX6661 to automatically set fan speed proportional to temperature. Full control of the fan is available by being able to open either the thermal control loop or the fan control loop. Figure 1 shows a simplified block diagram.

ADC

The ADC is an averaging type that integrates the signal input over a 125ms period with excellent noise rejection. A bias current is steered through the remote diode, where the forward voltage is measured, and the

temperature is computed. The DXN pin is the cathode of the remote diode and is biased at 0.7V above ground by an internal diode to set up the ADC inputs for a differential measurement. The worst-case DXP-DXN differential input voltage range is 0.25V to 0.95V. Excess resistance in series with the remote diode causes about 1/2°C error per ohm. Likewise, 200mV of offset voltage forced on DXP-DXN causes approximately 1°C error.

A/D Conversion Sequence

A temperature-conversion sequence is initiated every 500ms in the free-running autoconvert mode (bit 6 = 0 in the configuration register) or immediately by writing a one-shot command. The result of the new measurement is available after the end of conversion. The results of the previous conversion sequence are still available when the ADC is converting.

Remote-Diode Selection

Temperature accuracy depends on having a good-quality, diode-connected, small-signal transistor. Accuracy has been experimentally verified for all devices listed in Table 1. The MAX6661 can also directly measure the die temperature of CPUs and other ICs that have on-board temperature-sensing diodes.

Remote Temperature-Controlled Fan-Speed Regulator with SPI-Compatible Interface

Table 1. Remote-Sensor Transistors

MANUFACTURER	MODEL NO.
Central Semiconductor (USA)	2N3904, 2N3906
Fairchild Semiconductor (USA)	2N3904, 2N3906
Rohm Semiconductor (Japan)	SST3904
Samsung (Korea)	KST3904-TF
Siemens (Germany)	SMBT3904
Zetex (England)	FMMT3904CT-ND

Note: Transistors must be diode connected (base shorted to collector).

The transistor must be a small-signal type with a relatively high forward voltage. Otherwise, the A/D input range could be violated. The forward voltage must be greater than 0.25V at 10 μ A. Check to ensure this is true at the highest expected temperature. The forward voltage must be less than 0.95V at 100 μ A. Check to ensure that this is true at the lowest expected temperature. Large power transistors, power diodes, or small-signal diodes must not be used. Also, ensure that the base resistance is less than 100 Ω . Tight specifications for forward-current gain ($50 < \beta < 150$, for example) indicate that the manufacturer has good process controls and that the devices have consistent V_{BE} characteristics. Bits 5–2 of the mode register can be used to adjust the ADC gain to achieve accurate temperature measurements with diodes not included in the recommended list or to calibrate individually the MAX6661 for use in specific control systems.

Thermal Mass and Self-Heating

When measuring the temperature of a CPU or other IC with an on-chip sense junction, the thermal mass of the sensor has virtually no effect; the measured temperature of the junction tracks the actual temperature within

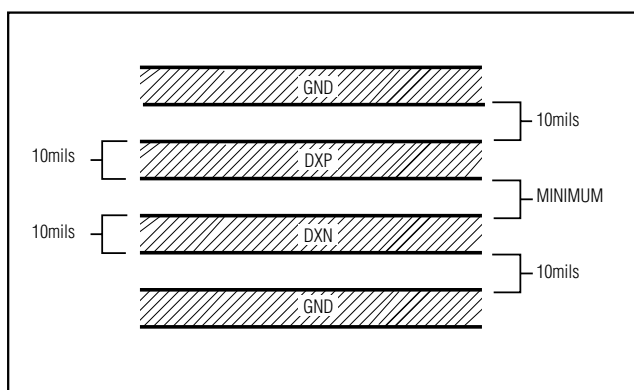

Figure 2. Recommended DXP-DXN PC Trace

a conversion cycle. When measuring temperature with discrete remote sensors, smaller packages (e.g., a SOT23) yield the best thermal response times. Take care to account for thermal gradients between the heat source and the sensor, and ensure that stray air currents across the sensor package do not interfere with measurement accuracy. Sensor self-heating, caused by the diode current source, is negligible.

ADC Noise Filtering

The ADC is an integrating type with inherently good noise rejection, especially of low-frequency noise such as 60Hz line interference. Micropower operation places constraints on high-frequency noise rejection; therefore, careful PC board layout and proper external noise filtering are required for high-accuracy remote measurements in electrically noisy environments. High-frequency EMI is best filtered at DXP and DXN with an external 2200pF capacitor. This value can be increased to about 3300pF (max), including cable capacitance. Capacitance higher than 3300pF introduces errors due to the rise time of the switched current source. Nearly all noise sources tested cause the ADC measurements to be higher than the actual temperature, typically by 1°C to 10°C, depending on the frequency and amplitude (see *Typical Operating Characteristics*).

PC Board Layout

Follow these guidelines to reduce the measurement error of the temperature sensors:

- 1) Place the MAX6661 as close as practical to the remote diode. In noisy environments, such as a computer motherboard, this distance can be 4in to 8in (typ). This length can be increased if the worst noise sources are avoided. Noise sources include CRTs, clock generators, memory buses, and ISA/PCI buses.
- 2) Do not route the DXP-DXN lines next to the deflection coils of a CRT. Also, do not route the traces across fast digital signals, which can easily introduce a 30°C error, even with good filtering.
- 3) Route the DXP and DXN traces in parallel and in close proximity to each other, away from any higher voltage traces, such as 12VDC. Leakage currents from PC board contamination must be dealt with carefully since a 20M Ω leakage path from DXP to ground causes about a 1°C error. If high-voltage traces are unavoidable, connect guard traces to GND on either side of the DXP-DXN traces (Figure 2).
- 4) Route through as few vias and crossunders as possible to minimize copper/solder thermocouple effects.

Remote Temperature-Controlled Fan-Speed Regulator with SPI-Compatible Interface

- 5) When introducing a thermocouple by inserting different metals in the connection path, make sure that both the DXP and the DXN paths have matching thermocouples, i.e., the connection paths are symmetrical. A copper-solder thermocouple exhibits $3\mu\text{V}/^\circ\text{C}$. Adding a few thermocouples causes a negligible error.
- 6) The 10mil widths and spacings that are recommended in Figure 2 are not absolutely necessary, as they offer only a minor improvement in leakage and noise over narrow traces. Use wider traces when practical.
- 7) Add a 5Ω resistor in series with V_{CC} for best noise filtering (see *Typical Operating Circuit*).

PC Board Layout Checklist

- Place the MAX6661 close to the remote-sense junction.
- Keep traces away from high voltages (12V bus).
- Keep traces away from fast data buses and CRTs.
- Use recommended trace widths and spacings.
- Place a ground plane under the traces.
- Use guard traces connected to GND flanking DXP and DXN.
- Place the noise filter and the $0.1\mu\text{F}$ V_{CC} bypass capacitors close to the MAX6661.

Twisted-Pair and Shielded Cables

Use a twisted-pair cable to connect the remote sensor for distances longer than 8in or in very noisy environments. Twisted-pair cable lengths can be between 6ft and 12ft before noise introduces excessive errors. For longer distances, the best solution is a shielded twisted pair like that used for audio microphones. For example, Belden 8451 works well for distances up to 100ft in a noisy environment. At the device, connect the twisted pair to DXP and DXN and the shield to GND. Leave the shield unconnected at the remote sensor. For very long cable runs, the cable's parasitic capacitance often provides noise filtering, so the 2200pF capacitor can often be removed or reduced in value. Cable resistance also affects remote-sensor accuracy. For every ohm of series resistance, the error is approximately $1/2^\circ\text{C}$.

Low-Power Standby Mode

Standby mode reduces the supply current to less than $10\mu\text{A}$ (typ) by disabling the ADC, the control loop, and the fan driver. Enter standby mode by setting the RUN/STOP bit to 1 (bit 6) in the configuration byte register. In standby mode, all data is retained in memory,

and the SPI interface is alive and listening for SPI commands. In standby mode, the one-shot command initiates a conversion. Activity on the SPI bus causes the device to draw extra supply current.

If a standby command is received while a conversion is in progress, the conversion cycle is interrupted, and the temperature registers are not updated. The previous data is not changed and remains available.

SPI Interface

The data interface for the MAX6661 is compatible with SPI, QSPI™, and MICROWIRE™ devices. For SPI/QSPI, ensure that the CPU serial interface runs in master mode so that it generates the serial clock signal. Select a 2.5MHz clock frequency or lower, and set zero values for clock polarity (CPOL) and phase (CPHA) in the μP control registers.

Data is clocked into the MAX6661 at SDIN on the rising edge of SC when $\overline{\text{CS}}$ is low. The first byte is the command byte and the second byte is the data byte. The command byte can be either a read byte or a write byte (Table 2). The last bit READ/WRITE (LSB) of the command byte tells the MAX6661 whether it is a read or a write operation, where a high signifies a read, and a low signifies a write. When $\overline{\text{CS}}$ is high, the MAX6661 does not respond to any activity on the SPI bus. All valid communications on the SPI should have 16 bits except for the SPOR and the OSHT.

During a READ operation, the DOUT line goes low on the falling clock edge after the READ/WRITE bit (8th bit). The data in the shift register is moved to the DOUT line during the 8th to 15th falling-clock edges and the MSB of the data is available to be read at the rising edge of the 9th clock pulse. The remaining clock pulses in the READ operation shift the register contents on the negative clock edge so that they can be latched into the master on the positive edge. Any READ operation with less than 16 bits results in truncated data. Figure 3 shows the read cycle.

For a WRITE operation, the command byte is decoded during the 8th clock pulse. Then data is loaded into the shift register on the positive edges of the 9th to 16th clock pulses and transferred to the appropriate register on the negative edge of the 16th clock period. Any WRITE operation that does not have the 16th clock edge does not get shifted out of the shift register and thus is ignored. Since returning $\overline{\text{CS}}$ high resets the SPI interface at the end of a transfer, this cannot be done until after the 16th falling clock edge. If $\overline{\text{CS}}$ is returned high before this 16th falling clock edge, the appropriate

QSPI is a trademark of Motorola, Inc.

MICROWIRE is a trademark of National Semiconductor Corp.

Remote Temperature-Controlled Fan-Speed Regulator with SPI-Compatible Interface

Table 2. MAX6661 Command-Byte Bit Assignments

REGISTERS	COMMAND	POR STATE	FUNCTION
RRL	81h	00000000	Read Remote Temperature Low Byte (3MSBs)
RRH	83h	00000000	Read Remote Temperature High Byte (Sign Bit and First 7 Bits)
RSL	85h	00000000	Read Status Byte
RCL/WCL	87h/92h	00000000	Read/Write Configuration Byte
RFCR/WFCR	89h/94h	00000010	Read/Write Fan-Conversion Rate Byte
RTMAX/WTMAX	A1h/A4h	01100100 (+100°C)	Read/Write Remote T _{MAX}
RTHYST/WTHYST	A3h/A6h	01011111 (+95°C)	Read/Write Remote T _{HYST}
RTHIGH/WTHIGH	8Fh/9Ah	01111111 (+127°C)	Read/Write Remote T _{HIGH}
RTLW/WTLOW	91h/9Ch	11001001 (-55°C)	Read/Write Remote T _{LOW}
SPOR	F8h	N/A	Write Software POR
OSHT	9Eh	N/A	Write One-Shot Temperature Conversion
RTFAN/WTFAN	A9h/B2h	00111100 (+60°C)	Read/Write Fan-Control Threshold Temperature T _{FAN}
RFSC/WFSC	ABh/B4h	00000000	Read/Write Fan-Speed Control
RFG/WFG	ADh/B6h	10000000	Read/Write Fan Gain
RFTP	AFh	00000000	Read Fan Tachometer Period
RFTCL/WFTPLP	B1h/B8h	11111111	Read/Write Fan Tachometer Period Limit (Fan-Failure Limit)
RFTD/WFTD	BBh/BCh	00000001	Read/Write Fan Tachometer Divisor
RFS/WFS	BFh/C0h	11111111	Read/Write Full-Scale Register
RM/WM	F5h/F6h	00000000	Read/Write Mode Register
ID CODE	FDh	01001101	Read Manufacturer ID Code
ID CODE	FFh	00001001	Read Device ID Code

register is not loaded. DOUT is high impedance during a WRITE operation. Figure 4 shows the write cycle.

For single byte commands such as OSHT and SPOR, the operation need only be 7 bits long where the READ/WRITE bit is omitted. Here the command is loaded into the shift register on the rising edge of SC and the command is decoded during the high period of the 7th clock pulse. The 7th falling edge of SC shifts the command from the shift register to the appropriate register. CS can then go high after the SC low to CS high hold time t_{CSH} (see SPI AC Timing, *Electrical Characteristics*). Figure 5 shows the timing waveforms for the MAX6661's SPI interface.

Remote Temperature Data Register

Two registers, at addresses 81h and 83h, store the measured temperature data from the remote diode. The data format for the remote-diode temperature is 10 bits + sign, with each LSB corresponding to 0.125°C, in two's complement format (Table 3). Register 83h contains the sign bit and the first 7 bits. Bits 7, 6, and 5 of

register 81h are the 3LSBs. If the two registers are not read immediately, one after the other, their contents may be the result of two different temperature measurements, leading to erroneous temperature data. For this reason, a parity bit has been added to the 81h register. Bit 4 of this is zero if the data in 81h and 83h are from the same temperature conversion and 83h is read first. Otherwise, bit 4 is one. The remaining bits are don't cares. When reading temperature data, register 83h must be read first.

Alarm Threshold Registers

The MAX6661 provides four alarm threshold registers that can be programmed with a two's complement temperature value with each LSB corresponding to 1°C. The registers are T_{HIGH}, T_{LOW}, T_{MAX}, and T_{HYST}. If the measured temperature equals or exceeds T_{HIGH}, or is less than T_{LOW}, an ALERT interrupt is asserted. If the measured temperature equals or exceeds T_{MAX}, the OVERT output is asserted (see the *Overttemperature Output OVERT* section). The POR state for T_{HIGH} is

Remote Temperature-Controlled Fan-Speed Regulator with SPI-Compatible Interface

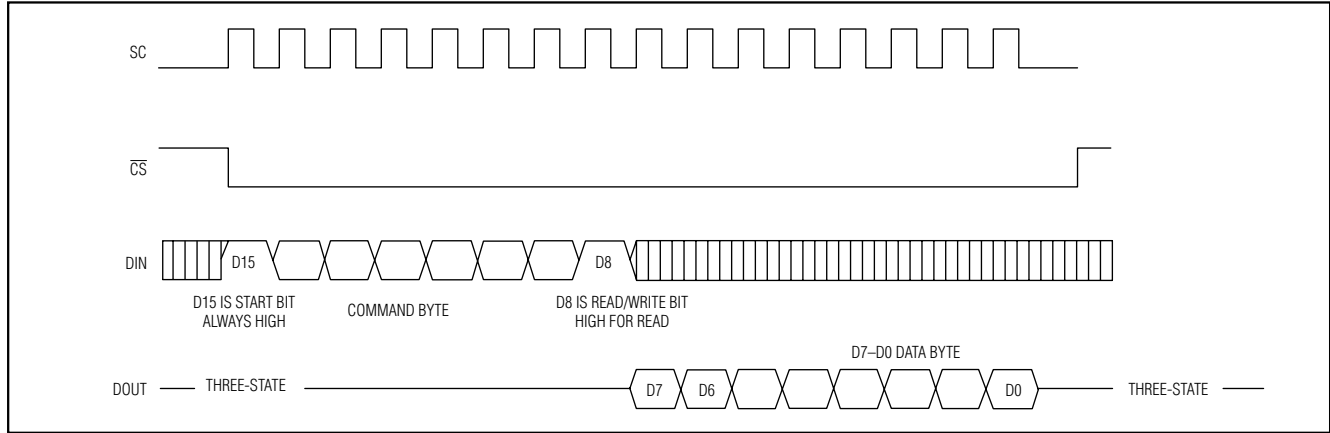

Figure 3. Read Cycle

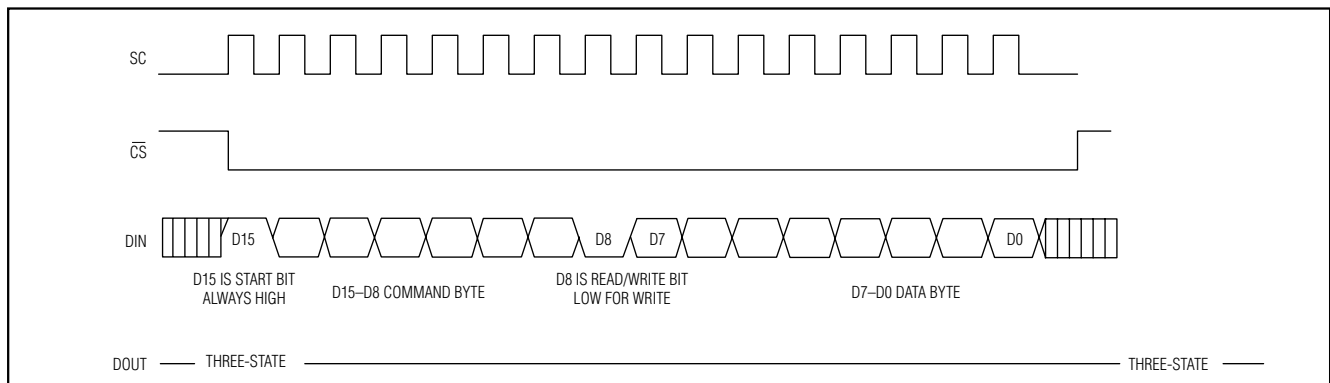

Figure 4. Write Cycle

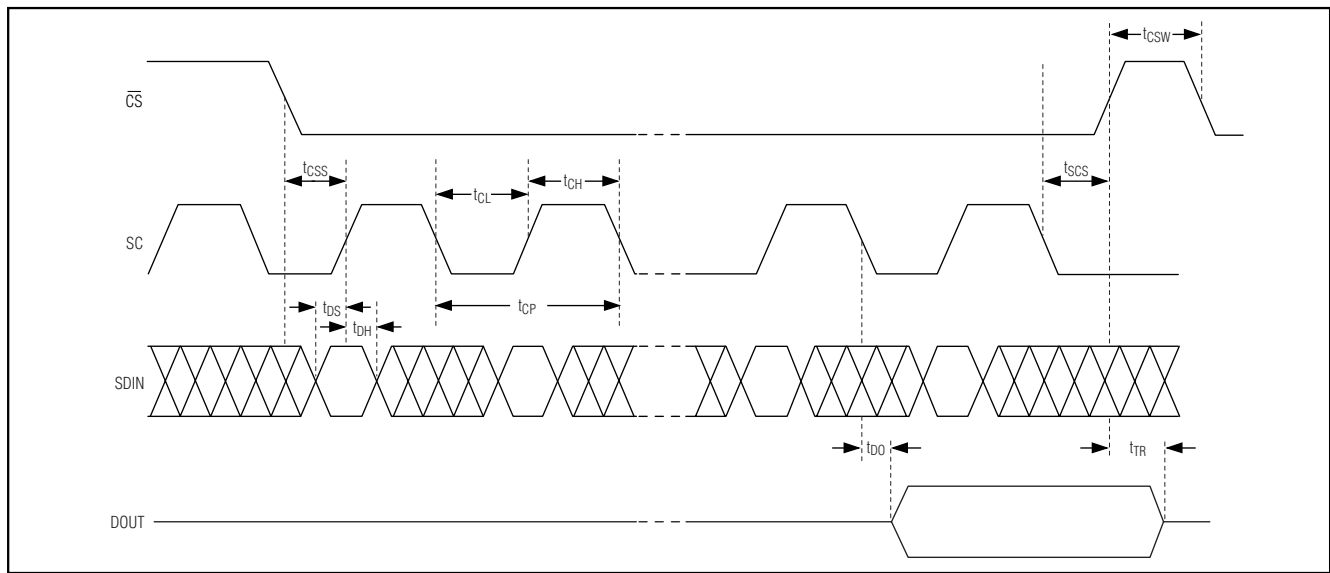

Figure 5. Serial Interface Timing

Remote Temperature-Controlled Fan-Speed Regulator with SPI-Compatible Interface

+127°C, for T_{LOW} is -55°C, for T_{MAX} is +100°C, and for T_{HYST} is +95°C.

Overtemperature Output (\overline{OVERT})

The MAX6661 has an overtemperature output (\overline{OVERT}) that is set when the remote-diode temperature crosses the limits set in the T_{MAX} register. It is always active if the remote-diode temperature exceeds T_{MAX} . The \overline{OVERT} line clears when the temperature drops below T_{HYST} . Bit 1 of the configuration register can be used to mask the \overline{OVERT} output. Typically, the \overline{OVERT} output is connected to a power-supply shutdown line to turn system power off. At power-up, \overline{OVERT} defaults to low when activated but the logic can be reversed by setting bit 5 of the configuration register. If reversed, \overline{OVERT} is a logic one when the T_{MAX} register temperature value is exceeded. The \overline{OVERT} line can be taken active, either by the MAX6661 or driven by an external source. \overline{OVERT} also acts as an input when set to go low when activated (default). If \overline{OVERT} is driven or forced low externally, the fan loop forces the fan to full speed and bit 1 of the status register is set. The \overline{OVERT} input can be masked out by bit 2 of the configuration register.

Diode Fault Alarm

A continuity fault detector at DXP detects an open circuit between DXP and DXN. If an open or short circuit exists, register 83h is loaded with 1000 0000. Additionally, if the fault is an open circuit, bit 2 of the status byte is set to 1 and the ALERT condition is activated at the end of the conversion. Immediately after POR, the status register indicates that no fault is present until the end of the first conversion.

ALERT Interrupts

The \overline{ALERT} interrupt output signal is activated (unless it is masked by bit 7 in the configuration register) whenever the remote-diode's temperature is below T_{LOW} or exceeds T_{HIGH} . A disconnected remote diode (for continuity detection), a shorted diode, or an active \overline{OVERT} also activates the \overline{ALERT} signal. The activation of the \overline{ALERT} signal sets the corresponding bits in the status register. Once activated, \overline{ALERT} is latched until cleared. To clear the \overline{ALERT} , read the status register.

The interrupt does not halt automatic conversions. New temperature data continues to be available over the SPI interface after \overline{ALERT} is asserted. \overline{ALERT} is an active-low open-drain output so that devices can share a common interrupt line. The interrupt is updated at the end of each temperature conversion so, after being cleared, it reappears after the next temperature conversion if the cause of the fault has not been removed.

Table 3. Temperature Data Format (Two's Complement)

TEMP (°C)	DIGITAL OUTPUT
+127	0111 1111 111
+125.00	0111 1101 000
+25	0001 1001 000
+0.125	0000 0000 001
0	0000 0000 000
-0.125	1111 1111 111
-25	1110 0111 111
-40	1101 1000111

By setting bit 0 in the configuration register to 1, the \overline{ALERT} line always remains high. Prior to taking corrective action, always check to ensure that an interrupt is valid by reading the current temperature and the status register.

Example: The remote temperature reading crosses T_{HIGH} , activating \overline{ALERT} . The host responds to the interrupt by reading the status register, clearing the interrupt. If the condition persists, the interrupt reappears.

One Shot

The one-shot command immediately forces a new conversion cycle to begin. In software standby mode (RUN/STOP bit = high), a new conversion is begun by writing an OSHT (9Eh) command. After the conversion, the device returns to standby mode. If a conversion is in progress when a one-shot command is received, the command is ignored. If a one-shot command is between conversions in autoconvert mode (RUN/STOP bit = low), a new conversion begins immediately.

Configuration Register Functions

The configuration register table (Table 4) describes this register's bit assignments.

Status Register Functions

The status byte (Table 5) reports several fault conditions. It indicates when the fan driver transistor of the MAX6661 has overheated and/or in thermal shutdown, when the temperature thresholds, T_{LOW} and T_{HIGH} , have been exceeded, and whether there is an open circuit in the DXP-DXN path. The register also reports the state of the \overline{ALERT} and \overline{OVERT} lines and indicates when the fan driver is fully on. The final bit in the status register indicates when a fan failure has occurred.

After POR, the normal state of the flag bits is zero, assuming no alert or overtemperature conditions are

Remote Temperature-Controlled Fan-Speed Regulator with SPI-Compatible Interface

Table 4. Configuration Register Bit Assignments

BIT	NAME	POR STATE	DESCRIPTION
7(MSB)	$\overline{\text{ALERT}}$ Mask	0	When set to 1, $\overline{\text{ALERT}}$ is masked from internally generated errors.
6	Run/Stop	0	When set to 1, the MAX6661 enters low-power standby.
5	$\overline{\text{OVERT}}$ Polarity	0	0 provides active low, 1 provides active high.
4	Write Protect	0	When set to 1, Write Protect is in effect for the following applicable registers: 1. Configuration register bits 6, 5, 4, 3 2. T _{MAX} register 3. THYST register 4. Fan conversion rate register
3	Thermal Closed/ Open Loop	0	When set to 1, the thermal loop is open. The fan speed control retains the last closed-loop value unless overwritten by a bus command (in closed loop, the fan speed control is read only). If fan mode is set to open loop by writing a 1 to bit 0 of the fan gain register, then this bit is automatically set.
2	$\overline{\text{OVERT}}$ Input Inhibit	0	When set to 1, an external signal on $\overline{\text{OVERT}}$ is masked from bit 1 of the status register.
1	Mask $\overline{\text{OVERT}}$ Output	0	Mask the $\overline{\text{OVERT}}$ output from an internally generated overtemperature error.
0	N/A	0	Not used.

Table 5. Status Register Bit Assignments

BIT	NAME	POR STATE	DESCRIPTION
7(MSB)	MAX6661 Overheat	0	When high, indicates that the fan driver transistor of the MAX6661 has overheated (temperature > +150°C) and is in thermal shutdown. The fan driver remains disabled until temperature falls below +140°C.
6	$\overline{\text{ALERT}}$	0	When high, indicates $\overline{\text{ALERT}}$ has been activated (pulled low), regardless of cause (internal or external).
5	Fan Driver Full Scale	0	When high, indicates the fan driver is at full scale. Only valid in fan closed-loop mode.
4	Remote High	0	When high, the remote-junction temperature exceeds the temperature in the remote high register.
3	Remote Low	0	When low, the remote-junction temperature is lower than the temperature in the remote low register.
2	Diode Open	0	When high, the remote-junction diode is open.
1	$\overline{\text{OVERT}}$	0	When active, indicates that $\overline{\text{OVERT}}$ has been activated, regardless of cause (internal or external).
0	Fan Failure	0	When high, indicates the count in the fan tachometer period register is higher than the limit set in the fan tachometer period limit register.

present. Bits 2 through 6 of the status register are cleared by any successful read of the status register, unless the fault persists. The $\overline{\text{ALERT}}$ output follows the status flag bit. Both are cleared when successfully read, but if the condition still exists, the $\overline{\text{ALERT}}$ and the

corresponding status bit are reasserted at the end of the next conversion.

When autoconverting, if the T_{HIGH} and T_{LOW} limits are close together, it is possible for both high-temperature and low-temperature status bits to be set, depending

Remote Temperature-Controlled Fan-Speed Regulator with SPI-Compatible Interface

on the amount of time between status read operations. In these circumstances, it is best not to rely on the status bits to indicate reversals in long-term temperature changes. Instead, use a current temperature reading to establish the trend direction.

Manufacturer and Device ID Codes

Two ROM registers provide manufacturer and device ID codes. Reading the manufacturer ID returns 4D, which is the ASCII code M (for Maxim). Reading the device ID returns 09h, indicating the MAX6661 device.

POR and UVLO

The MAX6661 has a volatile memory. To prevent unreliable power-supply conditions from corrupting the data in memory and causing erratic behavior, a POR voltage detector monitors V_{CC} and clears the memory if V_{CC} falls below 1.91V (see *Electrical Characteristics*). When power is first applied and V_{CC} rises above 2.0V (typ), the logic blocks begin operating, although reads and writes at V_{CC} levels below 3.0V are not recommended. A second V_{CC} comparator, the ADC UVLO comparator prevents the ADC from converting until there is sufficient headroom ($V_{CC} = 2.89V$ typ).

The software POR (SPOR) command can force a power-on reset of the MAX6661 registers through the serial interface. This can be done by writing F8h to the MAX6661.

Power-up defaults include:

- Interrupt latch is cleared.
- ADC begins autoconverting.
- Command register is set to 00h to facilitate quick-internal Receive Byte queries.
- T_{HIGH} and T_{LOW} registers are set to +127°C and -55°C, respectively.
- T_{HYST} and T_{MAX} are set to +95°C and +100°C, respectively.

Fan Control

The fan-control function can be divided into the thermal loop, the fan-speed-regulation loop (fan loop), and the fan-failure sensor. The thermal loop sets the desired fan speed based on temperature while the fan-speed-regulation loop uses an internally divided down reference oscillator to regulate the fan speed. The fan-speed-regulation loop includes the fan driver and the tachometer sensor. The fan-failure sensor provides a FAN FAIL alarm that signals when the value in the fan tachometer period register is greater than the fan tachometer period limit register value, which corresponds to a fan going slower than the limit. The fan driver is an N-channel, 4Ω MOSFET with a 13.5V maximum V_{DS} whose

drain terminal connects to the low side of the fan. The tachometer sensor (TACH IN) of the MAX6661 is driven from the tachometer output of the fan and provides the feedback signal to the fan-speed regulation loop for controlling the fan speed. For fans without tachometer outputs, the MAX6661 can generate its own tachometer pulses by monitoring the commutating current pulses (see the *Commutating Current Pulses* section).

Thermal Loop

Thermal Closed Loop

The MAX6661 can be operated in a complete closed-loop mode, with both the thermal and fan loops closed, where the remote-diode sensor temperature directly controls fan speed. Setting bit 3 of the configuration register to zero places the MAX6661 in thermal closed loop (Figure 6). The remote-diode temperature sensor is updated every 500ms. The value is stored in a temporary register (TEMPDATA) and compared to the programmed temperature values in the T_{HIGH} , T_{LOW} , T_{HYST} , T_{MAX} , and T_{FAN} registers to produce the error outputs OVERT and ALERT.

The fan conversion rate (FCR) register (Table 6) can be programmed to update the TEMPDATA register every 0.5s to 32s. This enables control over timing of the thermal feedback loop to optimize stability.

The fan threshold (T_{FAN}) register value is subtracted from the UPDATE register value. If UPDATE exceeds T_{FAN} temperature, then the fan-speed control (FSC) register (Table 7), stores the excess temperature in the form of a 7-bit word with an LSB of 0.5°C. If the difference between the T_{FAN} and UPDATE registers is higher than 32°C, then bits 6-0 are set to 1. In thermal closed loop, the FSC register is READ ONLY.

The fan gain (FG) register (Table 8) determines the number of bits used in the fan-speed control register. This gain can be set to 4, 5, or 6. If bits 6 and 5 are set to 10, all 6 bits of TEMPDATA are used directly to program the speed of the fan so that the thermal loop has a control range of 32°C with 64 temperature steps from fan off to full fan speed. If bits 6 and 5 are set to 01, the thermal control loop has a control range of 16°C with 32 temperature steps from fan off to full fan speed. If bits 6 and 5 are set to 00, the thermal control loop has a control range of 8°C with 16 temperature steps from fan off to full fan speed.

Thermal Open Loop

Setting bit 3 of the configuration register (Table 4) to 1 places the MAX6661 in thermal open loop. In thermal open-loop mode, the FSC register is read/write.

Remote Temperature-Controlled Fan-Speed Regulator with SPI-Compatible Interface

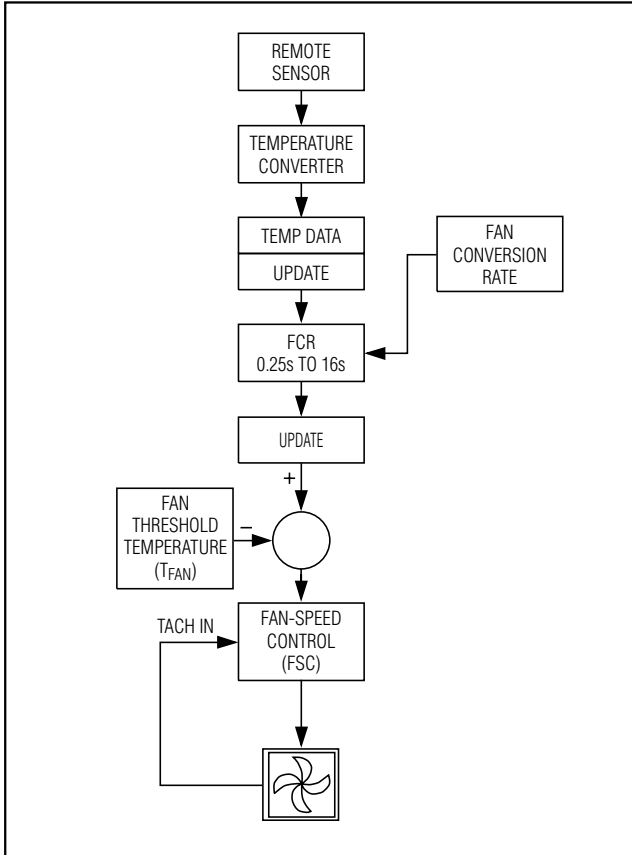

Figure 6. MAX6661 Thermal Loop

In thermal open-loop mode, the fan loop can operate in open or closed mode. In fan open loop, the FSC register programs fan voltage directly, accepting values from 0 to 64 (40h). For example, in fan open-loop mode, zero corresponds to no voltage across the fan and 40h corresponds to full fan voltage. Proportional control is available over the 0 to 63 (3Fh) range with 64 (40h) forcing unconditional full speed.

In fan closed-loop mode, zero corresponds to zero fan speed. When the FG register is set to 4 bits, 10h corresponds to 100% fan speed; 100% fan speed is 20h at 5 bits, and 3Fh at 6 bits.

Fan Loop

The fan loop (Figure 7) is based on an up/down counter where a reference clock representing the desired fan speed drives the count up, while tachometer pulses drive it down. The reference clock frequency is divided down from the MAX6661 internal clock to a frequency of 8415Hz. This clock frequency is further divided by

Table 6. Fan Conversion Update Rate

DATA	BINARY	FAN UPDATE RATE (Hz)	SECONDS BETWEEN UPDATES
00h	00000000	0.0625	16
01h	00000001	0.125	8
02h	00000010	0.25	4 (POR)
03h	00000011	0.5	2
04h	00000100	1	1
05h	00000101	2	0.5
06h	00000110	4	0.25

the fan full-scale (FS) register (Table 9), which is limited to values between 127 to 255, for a range of reference clock full-scale frequencies from 33Hz to 66Hz. A further division is performed to set the actual desired fan speed. This value appears in the fan-speed control register in thermal closed-loop mode. If the thermal loop is open, but the fan-speed control loop is closed, this value is programmable in the FSC. When in fan open-loop mode (which forces the thermal loop to open), the FSC register becomes a true DAC, programming the voltage across the fan from zero to nearly V_{FAN} . The tachometer input (TACH IN) includes a programmable (1/2/4/8) prescaler. The divider ratio for the (1/2/4/8) prescaler is stored in the fan tachometer divisor (FTD) register (Table 10). In general, the values in FTD should be set such that the full-speed fan frequency divided by the prescaler fall in the 33Hz to 66Hz range.

The UP/DN counter has six stages that form the input of a 6-bit resistive ladder DAC whose voltage is divided down from V_{FAN} . This DAC determines the voltage applied to the fan. Internal coding is structured such that when in fan closed-loop mode (which includes thermal closed loop), higher values in the 0 to 32 range correspond to higher fan speeds and greater voltage across the fan. In fan open-loop mode (which forces thermal open loop), acceptable values range from 0 to 63 (3Fh) for proportional control; a value of 64 (40h) commands unconditional full speed.

Fan closed-loop mode is selected by setting bit 0 of the FG to zero; open-loop mode is selected by setting bit 0 to 1. In open-loop mode, the gain block is bypassed and the FSC register is used to program the fan voltage rather than the fan speed. When in fan open-loop mode, both the temperature feedback loop and fan-speed control loop are broken, which result in the TACH IN input becoming disabled. A direct voltage can be applied to the fan after reading the temperature,

Remote Temperature-Controlled Fan-Speed Regulator with SPI-Compatible Interface

Table 7. Fan Speed Control Register (RFSC/WFSC)

REGISTER/ADDRESS	FSC (ABH = READ, B4H = WRITE)							
COMMAND	READ/WRITE FAN DAC REGISTER							
Label	7 Not Used	6 Overflow Bit	5 (MSB)	4 Data	3 Data	2 Data	1 Data	0 Data
POR State	0	0	0	0	0	0	0	0

Table 8. Fan Gain Register (RFG/WFG)

REGISTER/ADDRESS	FG (ADH = READ, B6H = WRITE)							
COMMAND	READ/WRITE FAN GAIN REGISTER							
Label	7 Always Write a 1	6 Fan Gain	5 Fan Gain	4 Always Write a 0	3 Always Write a 0	2 Always Write a 0	1 Fan Driver Mode Bit	0 Fan Feedback Mode
POR State	1	0	0	0	0	0	0	0

Notes: Bit 0: Fan driver mode. When bit 0 is set to 1, the fan driver is in fan open-loop mode. In this mode, the fan DAC programs the fan voltage rather than the fan speed. Tachometer feedback is ignored, and the user must consider minimum fan drive and startup issues. Thermal open loop is automatically set to 1 (see configuration register). Fan Fail (bit 0 of the status register) is set to 1 in this mode and should be ignored.

Bit 1: Fan feedback mode. When bit 1 is set to 1, the fan loop uses driver current sense rather than tachometer feedback.

Bits 6, 5: Fan gain of the fan loop, where 00 = 8°C with resolution = 4 bits. This means that the fan reaches its full-scale (maximum) speed when there is an 8°C difference between the remote-diode temperature and the value stored in T_{FAN} . 01 = +16°C, with a 5-bit resolution and 10 = +32°C with a 6-bit resolution.

Bit 7: Writing a zero to bit 7 forces bits 6 and 5 to their POR values.

Table 9. Fan Full-Scale Register (RFS/WFS)

REGISTER/ADDRESS	FS (BFH = READ, C0H = WRITE)							
COMMAND	READ/WRITE MAXIMUM TEMPERATURE LIMIT BYTE							
Label	7 MSB	6 Data Bit	5 Data Bit	4 Data Bit	3 Data Bit	2 Data Bit	1 Data Bit	0 Data Bit
POR State	1	1	1	1	1	1	1	1

Note: This register determines the maximum reference frequency at the input of the up/down counter. It controls a programmable divider that can be set anywhere between 127 and 255. The value in this register must be set in accordance with the procedure described in the TACH IN section (equivalent $8415/(\text{Max Tachometer Frequency} \times \text{Fan Tachometer Divisor})$). Programmed value below 127 defaults to 127. POR value is 255.

Table 10. Fan Tachometer Divisor Register (RFTD/WFTD)

REGISTER/ADDRESS	FTD (BBH = READ, BCH = WRITE)							
COMMAND	READ LIMIT/FAILURE REGISTER							
Label	7 Not Used	6 Not Used	5 Not Used	4 Not Used	3 Not Used	2 Not Used	1 Divisor Bit 1	0 Divisor Bit 0
POR State	0	0	0	0	0	0	0	1

Note: This byte sets the prescaler division ratio for tachometer or current-sense feedback. (This register does not apply to the tach signal used in the fan-speed register.) Select this value such that the fan frequency (rpm / 60s x number of poles) divided by the FCD falls in the 33Hz to 66Hz range. See TACH IN section:

Bits 1, 0: 00 = divide by 1, 01 = divide by 2, 10 = divide by 4, 11 = divide by 8.

Remote Temperature-Controlled Fan-Speed Regulator with SPI-Compatible Interface

using the FSC register. By selecting fan open-loop mode, the MAX6661 automatically invokes thermal open-loop mode.

Fan Conversion Rate Register

The FCR register (Table 6) programs the fan's update time interval in free-running autonomous mode (RUN/STOP = 0). The conversion rate byte's POR state is 02h (0.25Hz). The MAX6661 uses only the 3LSBs of this register. The 5MSBs are don't cares. The update rate tolerance is $\pm 25\%$ (max) at any rate setting.

Fan Driver

The fan driver consists of an amplifier and low-side NMOS power device whose drain is connected to FAN and is the connection for the low side of the fan. There is an internal connection from the fan to the input of the amplifier. The FET has 4Ω on-resistance with 320mA (typ) current limit. The driver has a thermal shutdown sensor that senses the driver's temperature. It shuts down the driver if the temperature exceeds $+150^\circ\text{C}$. The driver is reactivated once the temperature has dropped below $+140^\circ\text{C}$.

TACH IN

The TACH IN input connects directly to the tachometer output of a fan. Most commercially available fans have two tachometer pulses per revolution. The tachometer input is fully compatible with tachometer signals, which are pulled up to V_{FAN} .

Commutating Current Pulses

When a fan does not come equipped with a tachometer output, the MAX6661 uses commutating generated current pulses for speed detection. This mode is entered by setting the FG register's bit 1 to 1. An internal pulse is generated whenever a step increase occurs in the fan current. Connecting an external resistor between the GAIN pin and V_{CC} can reduce the sensitivity of pulses to changes in fan current. In general, the lower the resistor value, the lower the sensitivity, and the fan is easier to turn ON and can use a smaller external capacitor across its terminals. A suitable resistor range is $1\text{k}\Omega$ to $5\text{k}\Omega$.

Fan-Failure Detection

The MAX6661 detects fan failure by comparing the value in the fan tachometer period (FTP) register, a READ ONLY register, with a limit stored in the fan tachometer period limit (FTPL) register (Table 11). A counter counts the number of on-chip oscillator pulses between successive tachometer pulses and loads its value into the FTP register every time a tachometer pulse arrives. If the value in FTP is greater than the

value in FTPL, a failure is indicated. In fan closed loop, a flag is activated when the fan is at full speed.

Set the fan tachometer period limit byte to:

$$f_{\text{TACH}} = 8415 / [N \times f]$$

where N = fan-fail ratio and f_{TACH} = maximum frequency of the fan tachometer. The factor N is less than 1 and produces a fan-failure indication when the fan should be running at full speed, but is only reaching a factor of N of its expected frequency. The factor N is typically set to 0.75 for all fan speeds except at very low speeds where a fan failure is indicated by an overflow of the fan-speed counter. The overflow flag cannot be viewed separately in the status byte but is ORed with bit 0, the fan-fail bit.

Applications Information

Mode Register

Resistance in series with the remote-sensing junction causes conversion errors on the order of 0.5°C per ohm.

The MAX6661 mode register gives the ability to eliminate the effects of external series resistance of up to several hundred ohms on the remote temperature measurement and to adjust the temperature-measuring ADC to suit different types of remote-diode sensor. For systems using external switches or long cables to connect to the remote sensor, a parasitic resistance cancellation mode can be entered by setting mode register bit 7 = 1. This mode requires a longer conversion time and so can only be used for fan conversion rates of 1Hz or slower. Bits 6, 1, and 0 of the mode register are not used. Use bits 5–2 to adjust the ADC gain to achieve accurate temperature measurements with diodes not included in the recommended list or to individually calibrate the MAX6661 for use in specific control systems. These bits adjust gain to set the temperature reading at $+25^\circ\text{C}$, using two's complement format reading. Bit 5 is the sign (1 = increase, 0 = decrease), bit 4 = 2°C shift, bit 3 = 1°C shift, bit 2 = $1/2^\circ\text{C}$ shift. Origin of gain curve is referred to 0°K . To use this feature, the sensor must be calibrated by the user.

General Programming Techniques

The full-scale range of the fan-regulation loop is designed to accommodate fans operating between the 1000rpm to 8000rpm range of different fans. An on-chip 8415Hz oscillator is used to generate the 33Hz to 66Hz reference frequency. Choose the FTD value such that the fan full-speed frequency divided by this value falls in the 33Hz to 66Hz range. The full-scale reference frequency is further divided by the value in the FSC

Remote Temperature-Controlled Fan-Speed Regulator with SPI-Compatible Interface

MAX6661

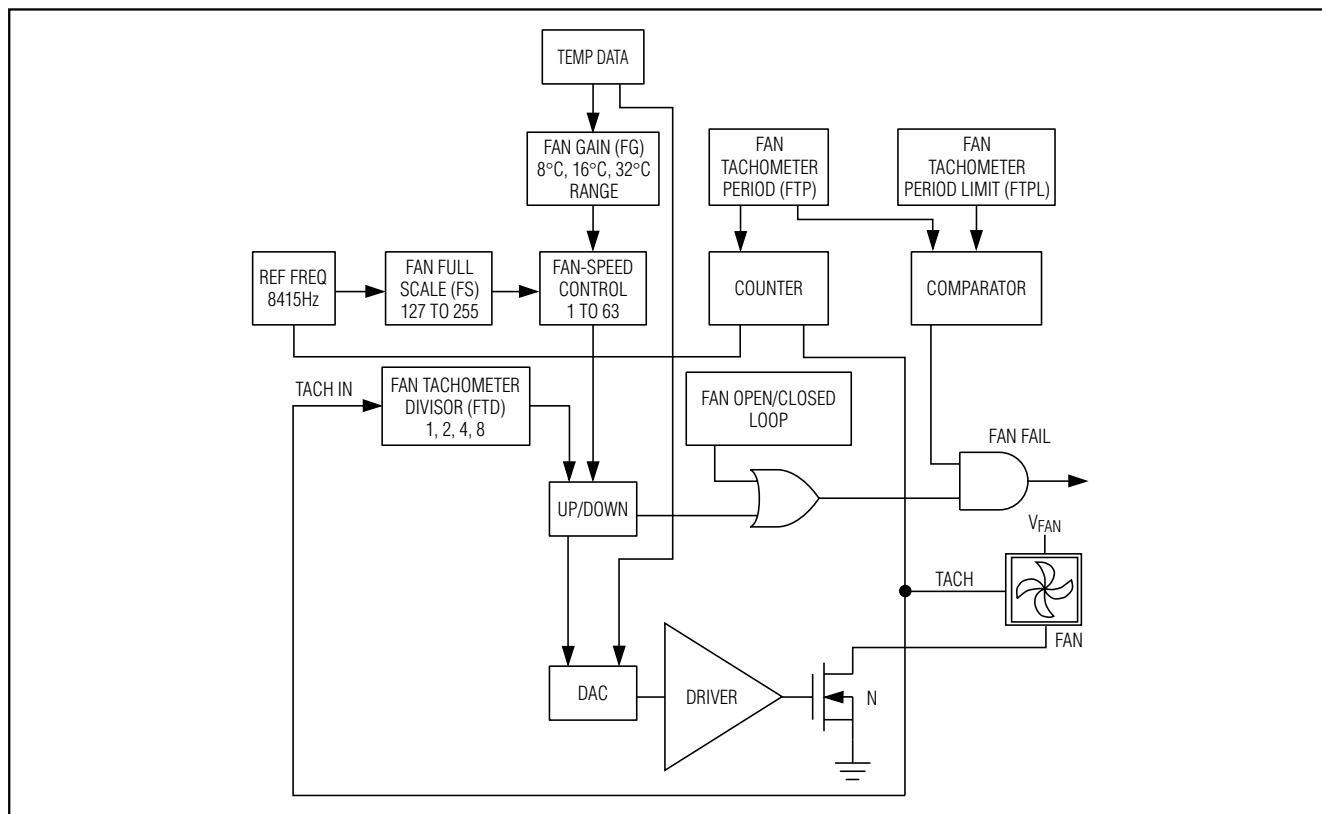

Figure 7. MAX6661 Fan Loop Functional Diagram

Table 11. Fan Tachometer Period Limit (RFTCL/WWFTCL)

REGISTER/ADDRESS	FL (B1H = READ, B8H = WRITE)							
COMMAND	READ LIMIT/FAILURE REGISTER							
Label	7 (MSB)	6 Data Bit	5 Data Bit	4 Data Bit	3 Data Bit	2 Data Bit	1 Data Bit	0 Data Bit
POR State	1	1	1	1	1	1	1	1

Note: The fan tachometer period limit register is programmed with the maximum speed that is compared against the value in the FS register to produce an error output to the status register.

register to the desired fan frequency [read: speed]. The 8415Hz is divided down from the MAX6661 internal clock, and has a $\pm 25^\circ\text{C}$ tolerance.

1) Determine the fan's maximum tachometer frequency:

$$f(\text{TACH}) \text{ Hz} = (\text{rpm}/60\text{s} / \text{min}) \times \text{number of poles}$$

Where poles = number of pulses per revolution. Most fans are two poles; therefore, they have two pulses per revolution.

2) Set the programmable FTD so that the frequency of the fan tachometer divided by the prescaler value in the FCD register falls in the 33Hz to 66Hz range.

3) Determine the value required for the fan FS register:

$$\text{FS} = 8415 / (f(\text{TACH}) \times P)$$

Where P is the prescaler division ratio of the FCD register.

Example: Fan A has a 2500rpm rating and 2 poles:

$$f(\text{TACH}) = 2500 / 60 \times 2 = 83.4\text{Hz}$$

Remote Temperature-Controlled Fan-Speed Regulator with SPI-Compatible Interface

The 83.4Hz value is out of the 33Hz to 66Hz decrement/increment range.

Set bits in the FTD register to divide the signal down within the 33Hz to 66Hz range. Bits 1, 0 = 10 (divide by 2: $P = 2$). The result is $83.4\text{Hz}/2 = 41.7\text{Hz}$.

- 4) Set the FS register to yield approximately 42Hz:

$$42\text{Hz} = 8415\text{Hz} / \text{FS (value)}$$

$$\text{FS (value)} \approx 200$$

$$\text{FS register} = 11001000$$

- 5) In current-sense feedback, a pulse is generated whenever there is a step increase in fan current. The frequency of pulses is then not only determined by the fan rpms and the number of poles, but also by the update rate at which the fan driver forces an increase in voltage across the fan.

The maximum pulse frequency is then given by:

$$f_C \text{ Hz} = f_{\text{TACH}} \times P / (P-1)$$

Where $f = (\text{rpm}/60) \times \text{poles}$ and P is the value in FTD.

The value required for the fan FS register is:

$$\text{FS} = 8415\text{Hz} / (f_{\text{TACH}} / (P-1))$$

The fan speed limit in FTPL should be set to:

$$f_L = 8415\text{Hz} / (N \times f_{\text{TACH}})$$

A value of $P = 1$ cannot be used in current-sense mode.

Fan Selection

For closed-loop operation and fan monitoring, the MAX6661 requires fans with tachometer outputs. A tachometer output is typically specified as an option on many fan models from a variety of manufacturers. Verify the nature of the tachometer output (open collector, totem pole) and the resultant levels and configure the connection to the MAX6661. For a fan with an open-drain/collector output, a pullup resistor of typically $5\text{k}\Omega$ must be connected between TACH IN and V_{FAN} . Note how many pulses per revolution are generated by the tachometer output (this varies from model to model and among manufacturers, though two pulses per revolution are the most common). Table 12 lists the representative fan manufacturers and the model they make available with tachometer outputs.

Low-Speed Operation

Brushless DC fans increase reliability by replacing mechanical commutation with electronic commutation. By lowering the voltage across the fan to reduce its speed, the MAX6661 is also lowering the supply voltage for the electronic commutation and tachometer

Table 12. Fan Manufacturers

MANUFACTURER	FAN MODEL OPTION
Comair Roton	All DC brushless models can be ordered with optional tachometer output.
EBM-Papst	Tachometer output optional on some models.
JMC	Tachometer output optional.
NMB	All DC brushless models can be ordered with optional tachometer output.
Panasonic	Panaflo and flat unidirectional miniature fans can be ordered with tachometer output.
Sunon	Tachometer output optional on some models.

electronics. If the voltage supplied to the fan is lowered too far, the internal electronics may no longer function properly. Some of the following symptoms are possible:

- The fan may stop spinning.
- The tachometer output may stop generating a signal.
- The tachometer output may generate more than two pulses per revolution.

The problems that occur and the supply voltages at which they occur depend on which fan is used. As a rule of thumb, 12V fans can be expected to experience problems somewhere around 1/4 and 1/2 their rated speed.

Chip Information

TRANSISTOR COUNT: 6479

PROCESS: BiCMOS

Remote Temperature-Controlled Fan-Speed Regulator with SPI-Compatible Interface

MAX6661

Pin Configuration

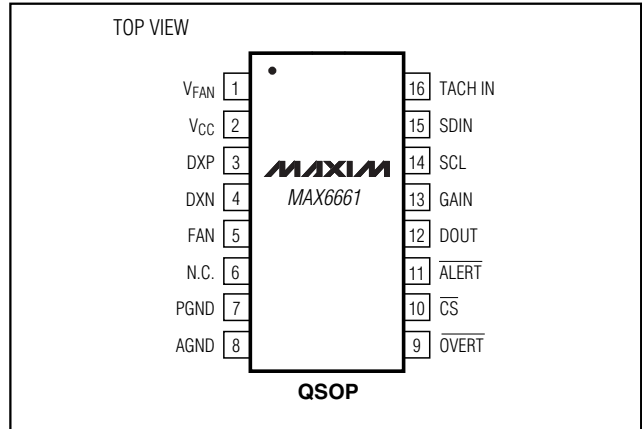

Package Information

DIM	INCHES		MILLIMETERS	
	MIN	MAX	MIN	MAX
A	.061	.068	1.55	1.73
A1	.004	.0098	0.102	0.249
A2	.055	.061	1.40	1.55
B	.008	.012	0.20	0.31
C	.0075	.0098	0.191	0.249
D	SEE VARIATIONS			
E	.150	.157	3.81	3.99
e	.025 BSC		0.635 BSC	
H	.230	.244	5.84	6.20
h	.010	.016	0.25	0.41
L	.016	.035	0.41	0.89
N	SEE VARIATIONS			
α	0°	8°	0°	8°

DIM	INCHES		MILLIMETERS		N
	MIN.	MAX.	MIN.	MAX.	
D	.189	.196	4.80	4.98	16 AA
S	.0020	.0070	0.05	0.18	
D	.337	.344	8.56	8.74	20 AB
S	.0500	.0550	1.270	1.397	
D	.337	.344	8.56	8.74	24 AC
S	.0250	.0300	0.635	0.762	
D	.386	.393	9.80	9.98	28 AD
S	.0250	.0300	0.635	0.762	

NOTES:

- 1). D & E DO NOT INCLUDE MOLD FLASH OR PROTRUSIONS.
- 2). MOLD FLASH OR PROTRUSIONS NOT TO EXCEED .006" PER SIDE.
- 3). CONTROLLING DIMENSIONS: INCHES.
- 4). MEETS JEDEC MO137.

MAXIM

PROPRIETARY INFORMATION

TITLE:
PACKAGE OUTLINE, QSOP, .150", .025" LEAD PITCH

APPROVAL	DOCUMENT CONTROL NO.	REV	1/1
	21-0055	D	

Maxim cannot assume responsibility for use of any circuitry other than circuitry entirely embodied in a Maxim product. No circuit patent licenses are implied. Maxim reserves the right to change the circuitry and specifications without notice at any time.

Maxim Integrated Products, 120 San Gabriel Drive, Sunnyvale, CA 94086 408-737-7600 _____ 19

Looking for pricing, stock, or lifecycle information?

Click below to explore more details on WIN SOURCE:

 [View MAX6661AEE+ on WIN SOURCE](#)

 [Maxim Integrated](#) Information

Optimize Your Supply Chain with WIN SOURCE Solutions

-  Global Sourcing Solution
-  Obsolete Management
-  Cost Control Management
-  Shortage Management
-  Alternative Solution
-  Excess Inventory Management