



**THE DATASHEET OF  
AUR9716AGD**



OBSOLETE - PART DISCONTINUED

**Description**

The AUR9716 is a high efficiency step-down DC-DC voltage converter. The chip operation is optimized by peak-current mode architecture with built-in synchronous power MOS switchers. It is automatically switching between the normal PWM mode and LDO mode to offer improved system power efficiency covering a wide range of loading conditions.

Switching frequency during 1.0MHz to 1.4MHz is set by an external resistor and integrated Soft-Start (SS), Under-Voltage-Lock-Out (UVLO), Thermal Shutdown Detection (TSD) and short circuit protection are designed to provide reliable product applications.

The device is available in adjustable output voltage versions ranging from 0.8V to  $V_{IN}$  when input voltage range is from 2.5V to 5.5V , and is able to deliver up to 2A.

The AUR9716 is available in DFN-3x3-8 package.

**Features**

- High Efficiency Buck Power Converter
- Low Quiescent Current
- 2A Output Current
- Low  $R_{DS(ON)}$  Internal Switches: 110mΩ
- Adjustable Output Voltage from 0.8V to  $V_{IN}$
- Wide Operating Voltage Range: 2.5V to 5.5V
- Built-In Power Switches for Synchronous Rectification with High Efficiency
- 800mV Feedback Voltage Allows Output
- Programmable Frequency: 1.0MHz to 1.4MHz
- Thermal Shutdown Protection
- Low Drop-Out Operation at 100% Duty Cycle
- No Schottky Diode Required

**Pin Assignments**

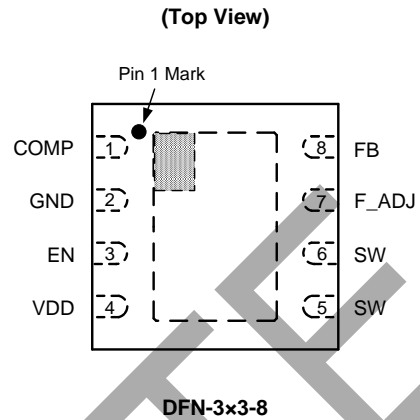

**Applications**

- LCD TV
- Post DC-DC Voltage Regulation
- PDA and Notebook Computers

Typical Applications Circuit

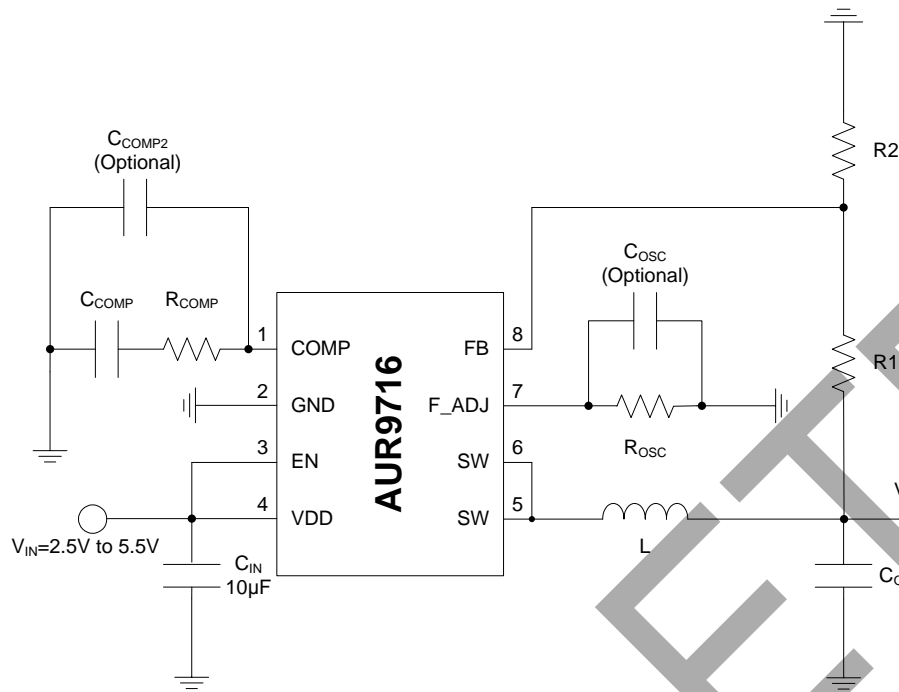

V <sub>OUT</sub> (V)	R1 (kΩ)	R2 (kΩ)
3.3	6.25	2
2.5	4.25	2
1.8	2.5	2
1.1	0.75	2

Switching Frequency (MHz)	R <sub>OSC</sub> (kΩ)	R <sub>COMP</sub> (kΩ)	C <sub>COMP</sub> (nF)	L (µH)	C <sub>OUT</sub> (µF)
1.0	536	3.6	1.5	2.2	10
1.2	976	4.3	1.0	1.5	10
1.4	5100	4.3	1.0	1.5	10

Table 1. Component Guide

OBSOLETE - PART DISCONTINUED

**Pin Descriptions**

Pin Number	Pin Name	Function
1	COMP	Compensation Point. COMP is used to compensate the regulation control loop. Connect R and C from COMP and GND to compensate the regulation control loop
2	GND	Ground. The exposed pad is soldered to PCB and connected to GND plant for good power dissipation
3	EN	Enable Input. EN is an input when the regulator on or off. When left unconnected, EN pin is pulled to VDD by the internal pull up resistor
4	VDD	Power input $V_{IN}$ provides the input power to the regulator. Connecting a ceramic bypass capacitor between VDD and GND to eliminate input noise and ripple voltage
5	SW	Switch Output. SW is the switching point which supplies voltage and current to output
6		
7	F_ADJ	Oscillator Resistor Input. Connecting a resistor to ground from this pin sets the switching frequency
8	FB	Feedback Input. Receives the feedback voltage from a resistive divider connected across the output. The feedback reference voltage is 0.8V typically

OBSOLETE - PART DISCONTINUED

**Functional Block Diagram**

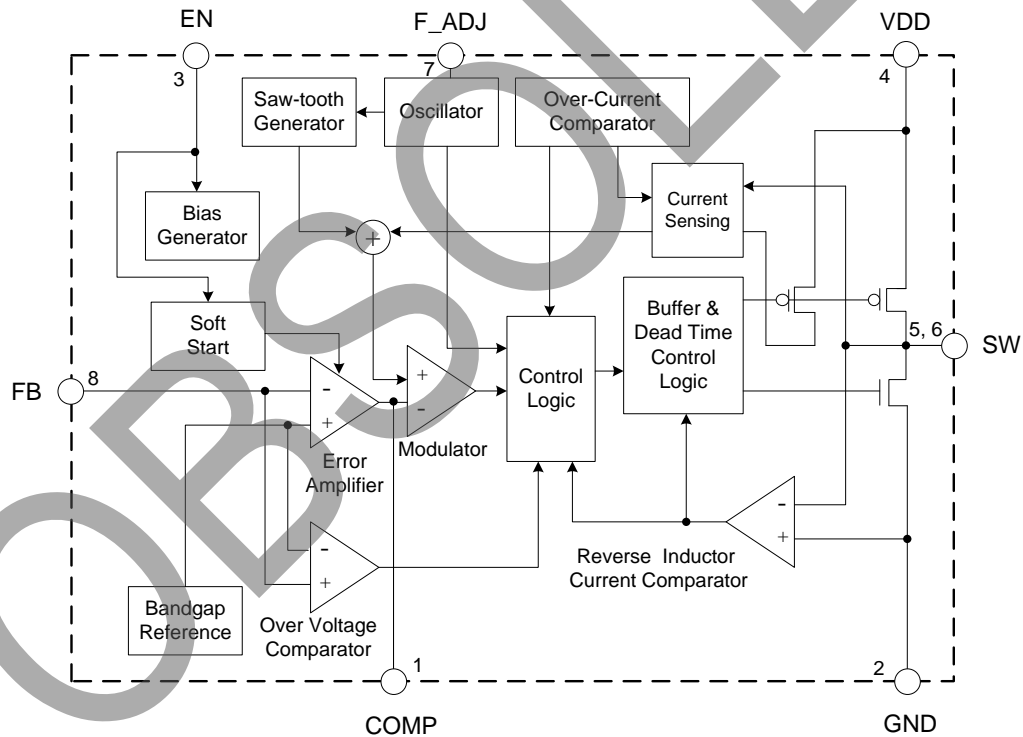

### Absolute Maximum Ratings (Note 1)

Symbol	Parameter	Value	Unit
$V_{IN}$	Supply Input Voltage	-0.3 to 6.0	V
$V_{SW}$	SW Pin Switch Voltage	-0.3 to $V_{IN}+0.3$	V
$V_{EN}$	Output Voltage	-0.3 to $V_{IN} +0.3$	V
$I_{SW-P}$	P-MOSFET Switch Source Current	3.5	A
$I_{SW-N}$	N-MOSFET Switch Sink Current	3.5	A
$P_D$	Power Dissipation (on PCB, $T_A=+25^{\circ}C$ )	2.56	W
$\theta_{JA}$	Package Thermal Resistance (Junction to Ambient)	39.13	$^{\circ}C/W$
$\theta_{JC}$	Package Thermal Resistance (Junction to Case)	3.39	$^{\circ}C/W$
$T_{LEAD}$	Lead Temperature (Soldering, 5sec)	+260	$^{\circ}C$
$T_J$	Junction Temperature	+150	$^{\circ}C$
$T_{OP}$	Operating Temperature Range	-40 to +85	$^{\circ}C$
$T_{STG}$	Storage Temperature Range	-55 to +150	$^{\circ}C$
$V_{HBM}$	ESD (Human Body Model)	2000	V
$V_{MM}$	ESD (Machine Model)	200	V

Note 1: Stresses greater than those listed under "Absolute Maximum Ratings" may cause permanent damage to the device. These are stress ratings only, and functional operation of the device at these or any other conditions beyond those indicated under "Recommended Operating Conditions" is not implied. Exposure to "Absolute Maximum Ratings" for extended periods may affect device reliability.

### Recommended Operating Conditions

Symbol	Parameter	Min	Max	Unit
$V_{IN}$	Supply Input Voltage	2.5	5.5	V
$T_J$	Junction Temperature Range	-20	+125	$^{\circ}C$
$T_A$	Operating Temperature Range	-40	+80	$^{\circ}C$

**Electrical Characteristics** ( $V_{IN}=5V$ ,  $V_{FB}=0.8V$ ,  $f_{OSC}=1.4MHz$ ,  $L=1.5\mu H$ ,  $C_{IN}=10\mu F$ ,  $C_{OUT}=10\mu F$ ,  $T_A=+25^\circ C$ , unless otherwise specified.)

Symbol	Parameter	Test Condition	Min	Typ	Max	Unit
$V_{IN}$	Input Voltage Range	–	2.5	–	5.5	V
$I_{OFF}$	Shutdown Current	$V_{EN}=0V$	–	0.1	1	$\mu A$
$I_{ON}$	Active Current	$V_{FB}=0.95V$	–	460	–	$\mu A$
$V_{FB}$	Regulated Feedback Voltage	For adjustable output voltage	0.784	0.8	0.816	V
$\Delta V_{OUT}/V_{OUT}$	Regulated Output Voltage	$V_{IN}=2.5V$ to $5.5V$ , $I_{OUT}=0A$ to $2A$	-3	–	3	%
$I_{PK}$	Peak Inductor Current	$V_{FB}=0.7V$	2.2	3.2	3.7	A
$f_{OSC}$	Oscillator Frequency	$R_{OSC}=5.1M\Omega$	1.12	1.4	1.68	MHz
		Adjustable switching frequency	1.0	–	1.4	
$R_{DS(on)(P)}$	P_MOSFET $R_{ON}$	$I_{SW}=0.5A$	90	110	130	m $\Omega$
$R_{DS(on)(N)}$	N_MOSFET $R_{ON}$	$I_{SW}=0.5A$	90	110	130	m $\Omega$
$V_{ENH}$	EN Input High-Threshold Voltage	Enable Threshold	1.5	–	–	V
$V_{ENL}$	EN Input Low-Threshold Voltage	Shutdown Threshold	–	–	0.4	V
$I_{EN}$	EN Input Current	–	–	2	–	$\mu A$
$t_{SS}$	Soft-start Time	–	–	800	–	$\mu s$
$D_{MAX}$	Maximum Duty Cycle	–	100	–	–	%
$V_{UVLO}$	Under Voltage Lock Out Threshold	$V_{IN}$ Rising	–	2.4	–	V
		$V_{IN}$ Falling	–	2.3	–	
		Hysteresis	–	0.1	–	
$T_{SD}$	Thermal Shutdown	Hysteresis= $30^\circ C$	–	+150	–	$^\circ C$
$g_m$	Error Amplifier Trans Conductance	–	–	3000	–	$\mu s$
$R_T$	Current Sense Trans Resistance	–	–	5	–	$\Omega$

OBSOLETE - PART DISCONTINUED

OBSOLETE

**OBSOLETE - PART DISCONTINUED**

**Performance Characteristics**

**Output Current vs. Efficiency**

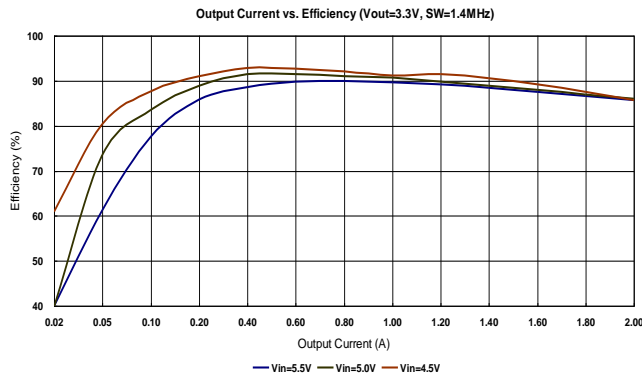

**Output Voltage vs. Output Current**

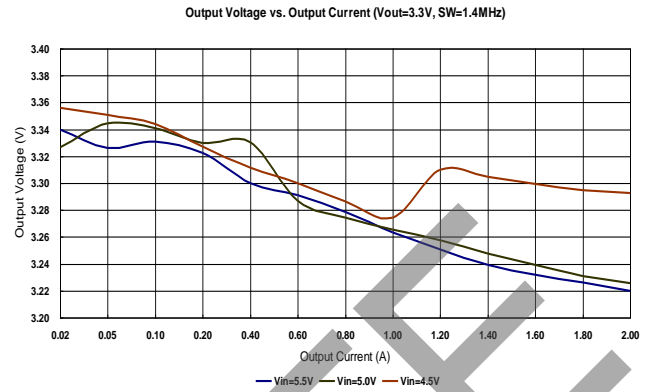

**Output Current vs. Efficiency**

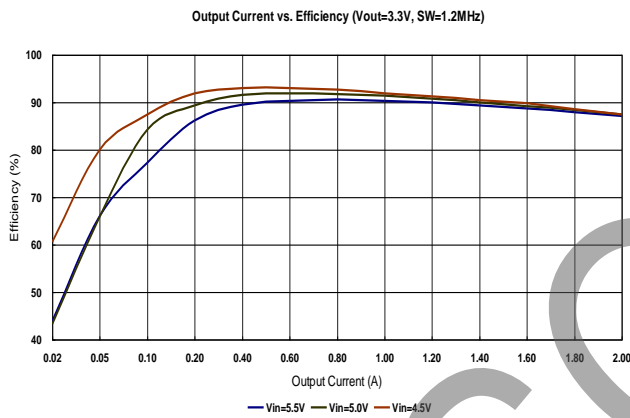

**Output Voltage vs. Output Current**

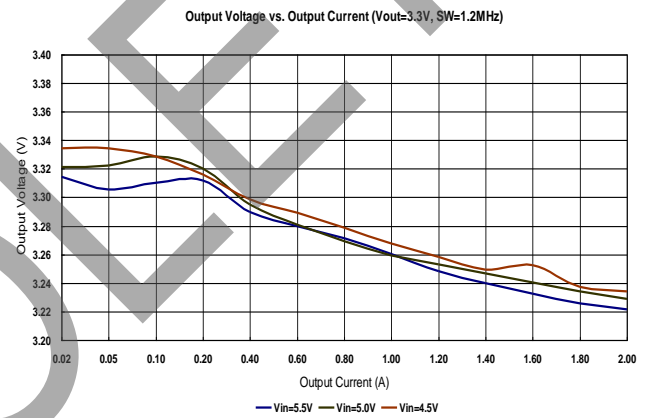

**Output Current vs. Efficiency**

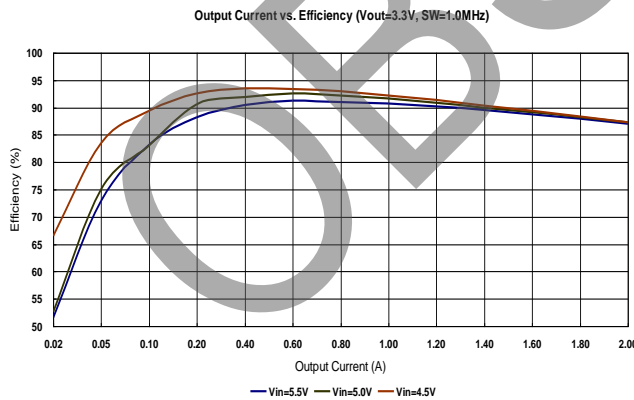

**Output Voltage vs. Output Current**

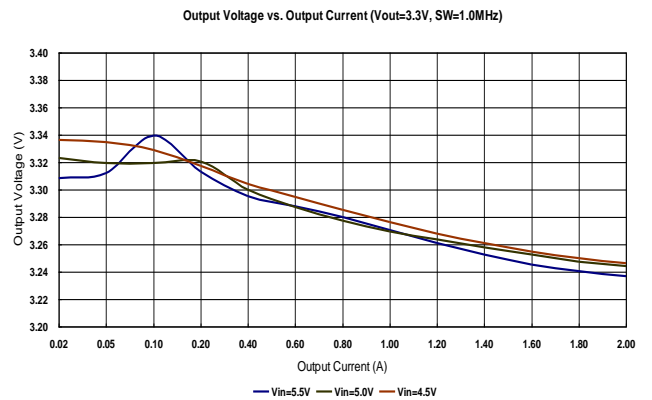

OBSOLETE - PART DISCONTINUED

**Performance Characteristics** (continued)

**Input Voltage vs. Shutdown Current**

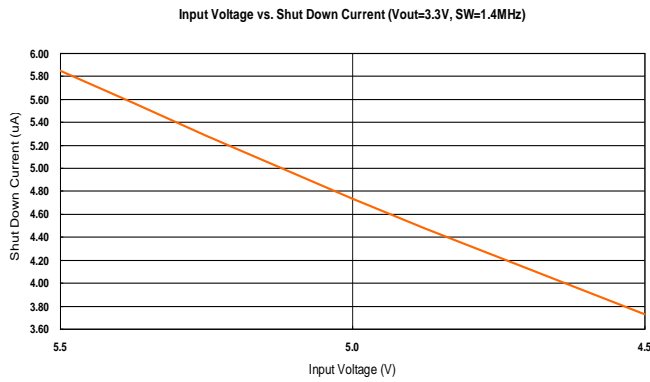

**Input Voltage vs. Quiescent Current**

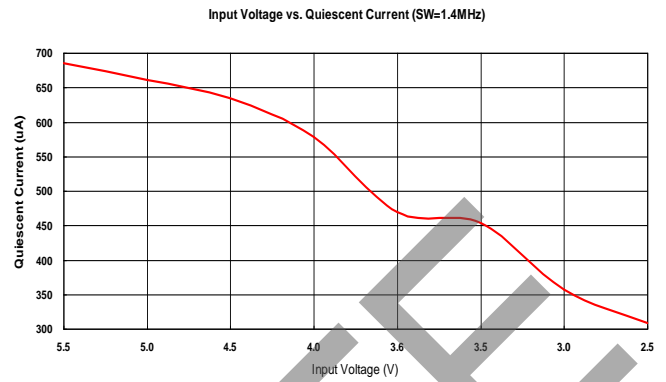

**Input Voltage vs. P\_MOSFET R<sub>DS</sub>**

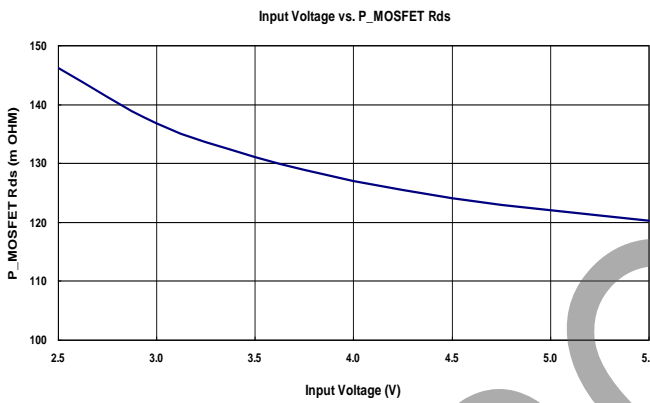

**Input Voltage vs. N\_MOSFET R<sub>DS</sub>**

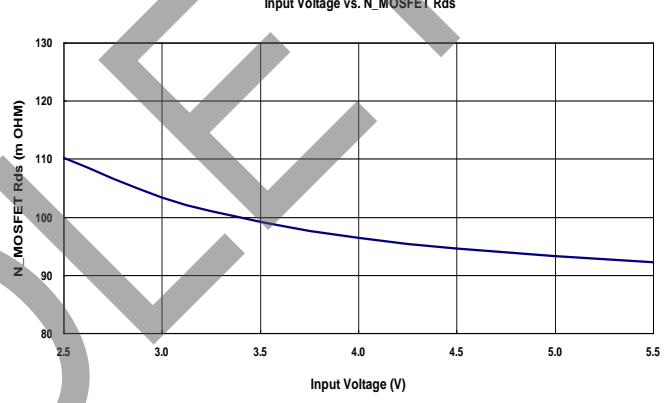

**Load Regulation (V<sub>IN</sub>=5V, V<sub>OUT</sub>=1.1V, f<sub>OSC</sub>=1.4MHz, I<sub>OUT</sub>=0.1A to 2A)**

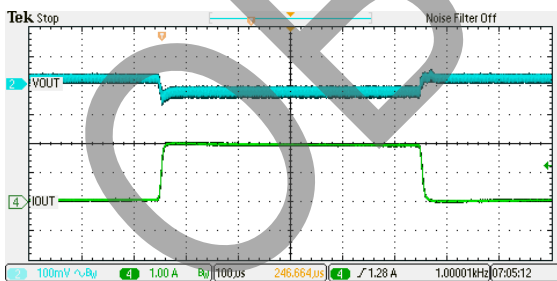

**Load Regulation (V<sub>IN</sub>=5V, V<sub>OUT</sub>=1.1V, f<sub>OSC</sub>=1.2MHz, I<sub>OUT</sub>=0.1A to 2A)**

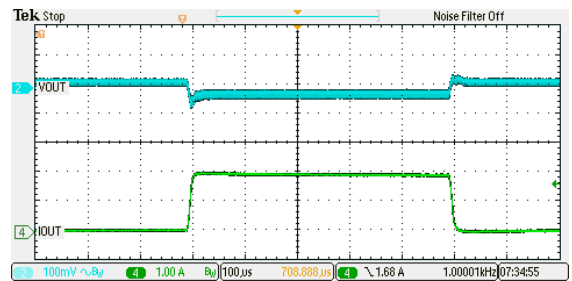

**Performance Characteristics** (continued)

**Load Regulation ( $V_{IN}=5V$ ,  $V_{OUT}=1.1V$ ,  
 $f_{OSC}=1.0MHz$ ,  $I_{OUT}=0.1A$  to  $2A$ )**

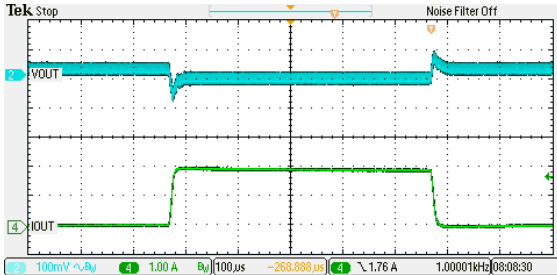

**Power Start-up ( $V_{IN}=0V$  to  $5V$ ,  
 $V_{OUT}=3.3V$ ,  $f_{OSC}=1.4MHz$ ,  $I_{OUT}=2A$ )**

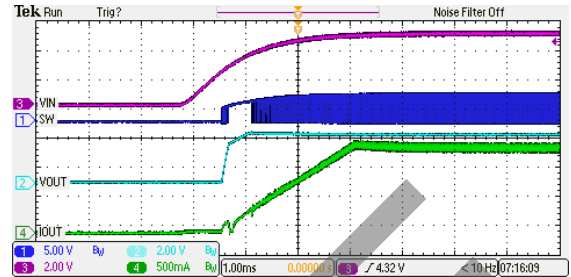

**Power Start-up ( $V_{IN}=0V$  to  $5V$ ,  
 $V_{OUT}=3.3V$ ,  $f_{OSC}=1.2MHz$ ,  $I_{OUT}=2A$ )**

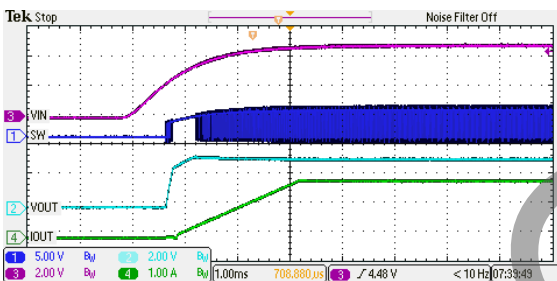

**Power Start-up ( $V_{IN}=0V$  to  $5V$ ,  
 $V_{OUT}=3.3V$ ,  $f_{OSC}=1.0MHz$ ,  $I_{OUT}=2A$ )**

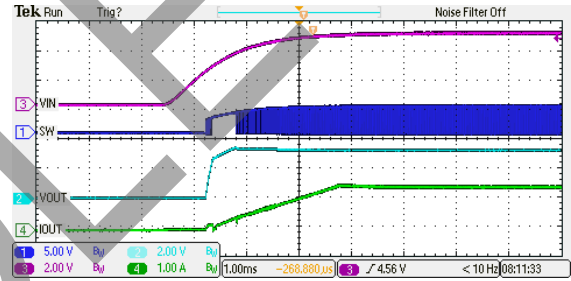

**Power Turn-off ( $V_{IN}=5V$  to  $0V$ ,  
 $V_{OUT}=3.3V$ ,  $f_{OSC}=1.4MHz$ ,  $I_{OUT}=2A$ )**

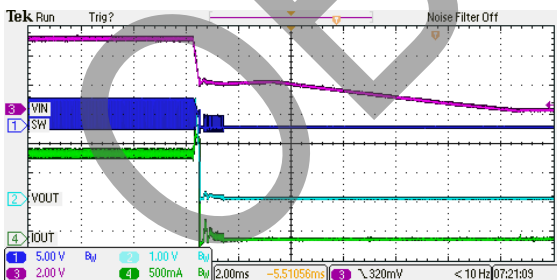

**Power Turn-off ( $V_{IN}=5V$  to  $0V$ ,  
 $V_{OUT}=3.3V$ ,  $f_{OSC}=1.2MHz$ ,  $I_{OUT}=2A$ )**

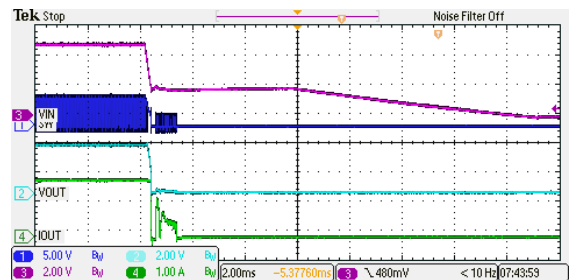

OBSOLETE - PART DISCONTINUED

**Performance Characteristics** (continued)

**Power Turn-off ( $V_{IN}=5V$  to  $0V$ ,  
 $V_{OUT}=3.3V$ ,  $f_{OSC}=1.0MHz$ ,  $I_{OUT}=2A$ )**

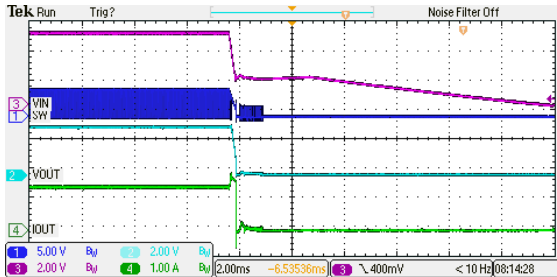

**Application Information**

The AUR9716 is a synchronous buck converter which can support switching frequency range from 1.0MHz to 1.4MHz and the output current can be up to 2A. The basic AUR9716 application circuits are shown as Typical Applications Circuit, external components selection is determined by the load current and is critical with the selection of inductor and capacitor values.

**1. Inductor Selection**

For most applications, the value of inductor is chosen based on the required ripple current with the range of 1.5μH to 4.7μH.

$$\Delta I_L = \frac{1}{f \times L} V_{OUT} \left(1 - \frac{V_{OUT}}{V_{IN}}\right)$$

The largest ripple current occurs at the highest input voltage. Having a small ripple current reduces the ESR loss in the output capacitor and improves the efficiency. The highest efficiency is realized at low operating frequency with small ripple current. However, the larger value inductors will be required. A reasonable starting point for ripple current setting is  $\Delta I_L = 40\% I_{MAX}$ . For a maximum ripple current stays below a specified value, the inductor should be chosen according to the following equation:

$$L = \left[ \frac{V_{OUT}}{f \times \Delta I_L (MAX)} \right] \left[ 1 - \frac{V_{OUT}}{V_{IN} (MAX)} \right]$$

The DC current rating of the inductor should be at least equal to the maximum output current plus half of the highest ripple current to prevent inductor core saturation. For better efficiency, the lower DC-resistance inductor should be selected.

**2. Capacitor Selection**

The input capacitance,  $C_{IN}$ , is needed to filter the trapezoidal current at the source of the top MOSFET. To prevent the large ripple voltage, a low ESR input capacitor sized for the maximum RMS current must be used. The maximum RMS capacitor current is given by:

$$I_{RMS} = I_{OMAX} \times \frac{[V_{OUT} (V_{IN} - V_{OUT})]^{\frac{1}{2}}}{V_{IN}}$$

It indicates a maximum value at  $V_{IN} = 2V_{OUT}$ , where  $I_{RMS} = \frac{I_{OUT}}{2}$ . This simple worse-case condition is commonly used for design because

even significant deviations do not much relief. The selection of  $C_{OUT}$  is determined by the equivalent series resistance (ESR) that is required to minimize output voltage ripple and load step transients, as well as the amount of bulk capacitor that is necessary to ensure the control loop is stable. Loop stability can be also checked by viewing the load step transient response as described in a latter section. The output ripple,  $\Delta V_{OUT}$ , is determined by:

$$\Delta V_{OUT} \leq \Delta I_L \left[ ESR + \frac{1}{8 \times f \times C_{OUT}} \right]$$

The output ripple is the highest at the maximum input voltage since  $\Delta I_L$  increases with input voltage.

## Application Information (continued)

### 3. Load Transient

A switching regulator typically takes several cycles to respond to the load current step. When a load step occurs,  $V_{OUT}$  immediately shifts by an amount equal to  $(\Delta I_{LOAD} \times ESR)$ , where ESR is the equivalent series resistance of output capacitor.  $\Delta I_{LOAD}$  also begins to charge or discharge  $C_{OUT}$  generating a feedback error signal used by the regulator to return  $V_{OUT}$  to its steady-state value. During the recovery time,  $V_{OUT}$  can be monitored for overshoot or ringing that would indicate a stability problem.

### 4. Output Voltage Setting

The output voltage of AUR9716 can be adjusted by a resistive divider according to the following formula:  $V_{OUT} = V_{FB} \times (1 + \frac{R_1}{R_2}) = 0.8V \times (1 + \frac{R_1}{R_2})$

When  $V_{FB}$  is the 0.8V feedback reference voltage, the resistive divider senses the fraction of the output voltage as shown in Figure of Setting the Output Voltage.

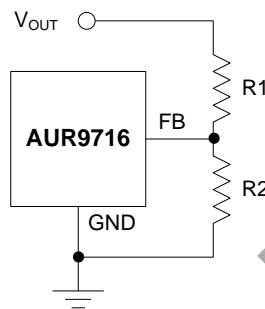

Setting the Output Voltage

### 5. Slope Compensation

The slope compensation of AUR9716 provides stability in constant frequency construction by preventing oscillations at duty cycle more than 50%. It's accomplished externally by adding a series of capacitor and resistor, as shown in Figure of. Stability Compensation Components

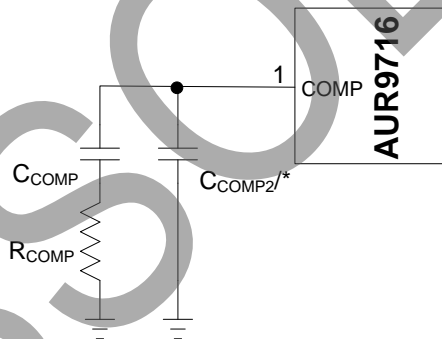

Stability Compensation Components

The DC loop gain of the system is determined by the following equation:

$$A_{VDC} = \frac{V_{FB}}{I_{OUT}} A_V G_{CS}$$

Where  $A_V$  is error amplifier voltage gain and  $G_{CS}$  is current sense transconductance.

The dominant pole P1 is due to  $C_{COMP}$ :

$$f_{P1} = \frac{G_{EA}}{2\pi A_V C_{COMP}}$$

Where  $G_{EA}$  is error amplifier transconductance.

The output pole P2 is due to  $C_{OUT}$ :

**OBSOLETE - PART DISCONTINUED**

**Application Information** (continued)

$$f_{P2} = \frac{I_{OUT}}{2\pi V_{OUT} C_{OUT}}$$

The zero Z1 is due to C<sub>COMP</sub> and R<sub>COMP</sub>:

$$f_{Z1} = \frac{1}{2\pi R_{COMP} C_{COMP}}$$

If C<sub>COMP2</sub> is used, the third pole is due to R<sub>COMP</sub> and C<sub>COMP2</sub>:

$$f_{P3} = \frac{1}{2\pi R_{COMP} C_{COMP2}}$$

Then the cross over frequency often sets at 1/5 to 1/10 of the switching frequency.

Table 1 shows some calculated results based on stability compensation equations above.

Switching Frequency (MHz)	1.4	1.2	1.0
R <sub>COMP</sub> (kΩ)	4.3	4.3	3.6
C <sub>COMP</sub> (nF)	1	1	1.5
L (μH)	1.5	1.5	2.2
C <sub>OUT</sub> (μF)	10	10	10

Table 1. Stability Compensation Components

To optimize the components for stability compensation listed in Table 1, we will introduce the selection value of R<sub>COMP</sub> and C<sub>COMP</sub> as detail as possible.

1. R<sub>COMP</sub>: determine this resistor value according to the desired crossover frequency is f<sub>c</sub>, default as 1.4MHz.

$$R_{COMP} = \frac{2\pi C_{OUT} f_c V_{OUT}}{G_{EA} G_{CS} V_{FB}}$$

2. C<sub>COMP</sub>: determine this capacitor value according to the desired phase margin. We often choose this compensation.

Zero point below one fourth of the crossover frequency to ensure the loop stability.

$$C_{COMP} > \frac{4}{2\pi R_{COMP} f_c}$$

**6. Short-Circuit Protection**

When AUR9716 output node is shorted to GND, as V<sub>FB</sub> drops under 0.4V, chip will enter soft-start to protect itself, when short circuit is removed, and V<sub>FB</sub> rises over 0.4V, the AUR9716 enters normal operation again. If AUR9716 reaches OCP threshold while short circuit, it will enter soft-start cycle until the current under OCP threshold. When AUR9716 is used to transfer V<sub>IN</sub>=5V to V<sub>OUT</sub>=2.5V, shorting V<sub>OUT</sub> to GND makes big current which enables SCP protection. The waveform is shown in Figure of SCP Protection.

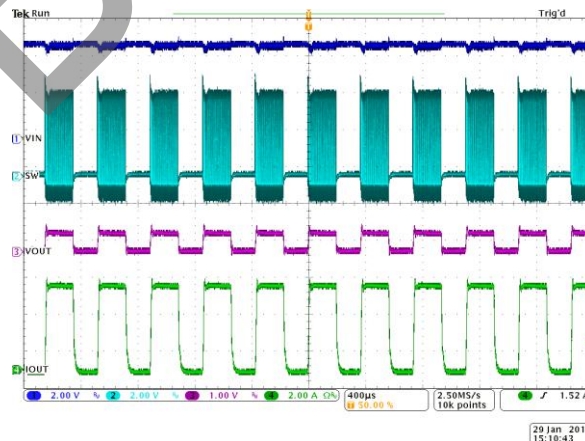

SCP Protection

**OBSOLETE - PART DISCONTINUED**

**Application Information** (continued)

**7. F\_ADJ : R<sub>osc</sub> Selection**

The AUR9716 can change switching frequency by choose different R<sub>osc</sub>, please refer to Table 2.

Switching Frequency (MHz)	1.4	1.2	1.0
R <sub>osc</sub> (kΩ)	5100	976	536

Table 2. R<sub>osc</sub> Setting

Due to get the better performance of AUR9716, F\_ADJ pin (Pin 7) could parallel 47pF capacitor with R<sub>osc</sub>, shown in Figure of F\_ADJ Components.

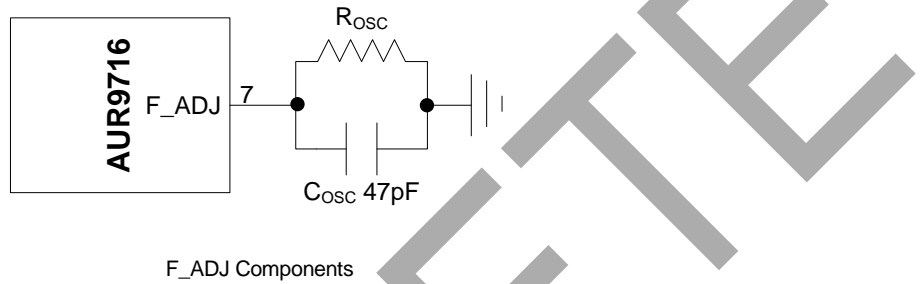

**8. Thermal Characteristics**

The max power dissipation depends on the thermal resistance of IC package, PCB layout, the rate of temperature between junction to ambient. The max power dissipation can be calculated by following formula:

$$P_{D(MAX)} = \left( \frac{T_{J(MAX)} - T_A}{\theta_{JA}} \right)$$

Where T<sub>J(MAX)</sub> is the maximum operation junction temperature, T<sub>A</sub> is the ambient temperature and θ<sub>JA</sub> is the junction to ambient thermal resistance.

**9. PC Board Layout Considerations**

When laying out the printed circuit board, the following checklist should be used to optimize the performance of AUR9716.

1. The power traces, including the GND trace, the SW trace and the VDD trace should be kept direct, short and wide.
2. To put the input capacitor as close as possible to the VDD and GND pins.
3. The FB pin should be connected directly to the feedback resistor divider.
4. Keep the switching node, SW, away from the sensitive FB pin and the node should be kept small area.

**Ordering Information**

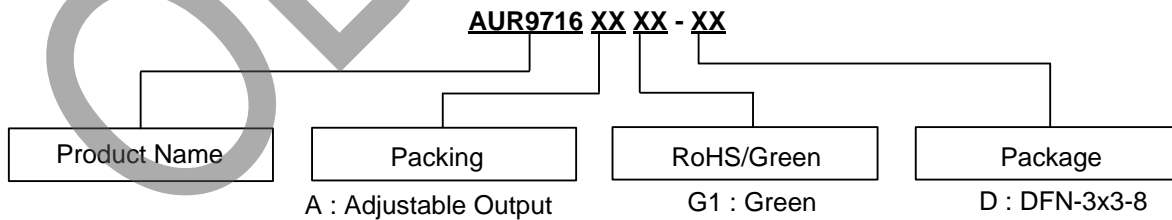

Package	Temperature Range	Part Number	Marking ID	Packing
DFN-3x3-8	-40 to +80°C	AUR9716AGD	9716A	Tape & Reel

**Package Outline Dimensions** (All dimensions in mm(inch).)

Please see <http://www.diodes.com/package-outlines.html> for the latest version.

**(1) Package Type: DFN-3x3-8**

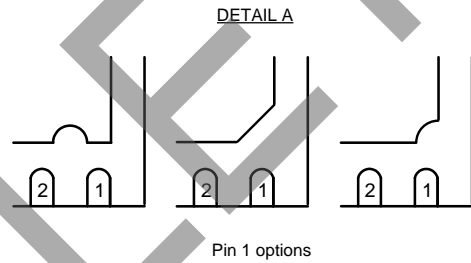
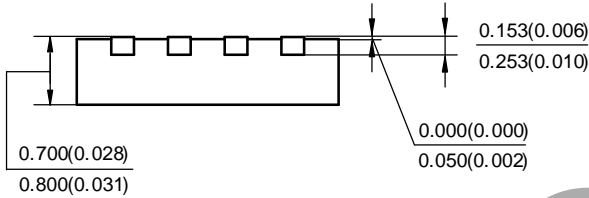
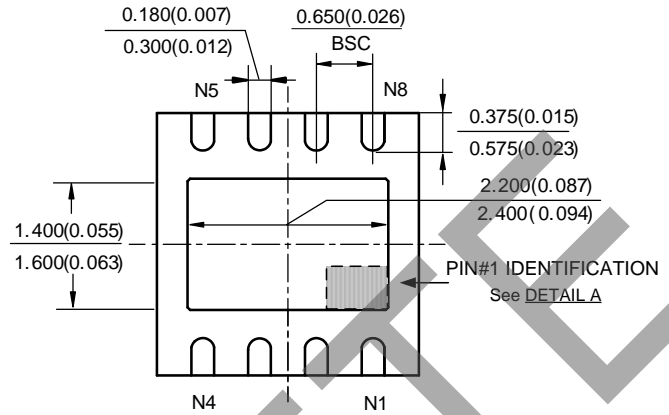
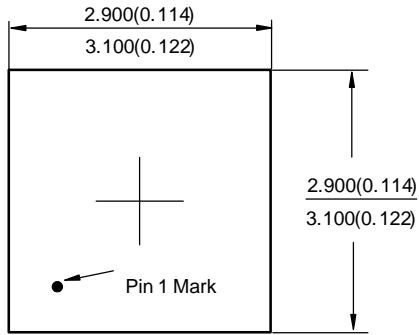

OBSOLETE - PART DISCONTINUED

OBSOLETE

**Suggested Pad Layout**

Please see <http://www.diodes.com/package-outlines.html> for the latest version.

(1) Package Type: DFN-3x3-8

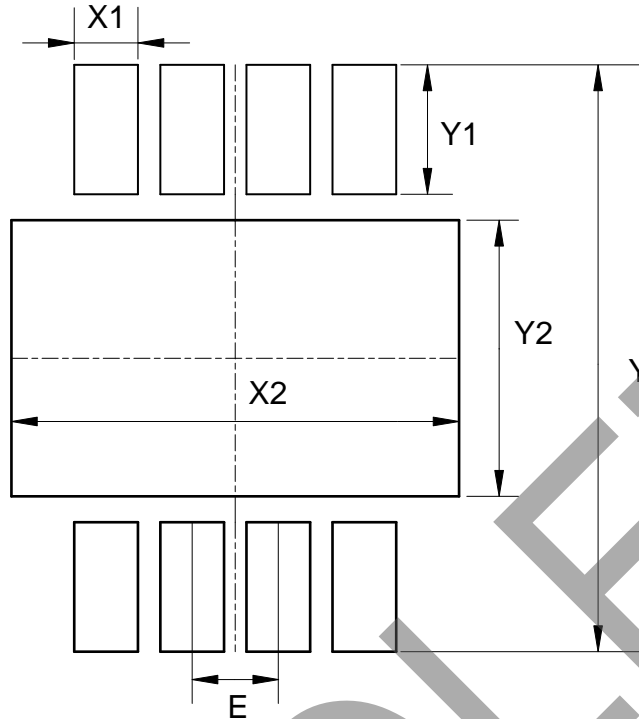

Dimensions	Y (mm)/(inch)	X1 (mm)/(inch)	Y1 (mm)/(inch)	X2 (mm)/(inch)	Y2 (mm)/(inch)	E (mm)/(inch)
Value	3.400/0.134	0.370/0.015	0.750/0.030	2.600/0.102	1.600/0.063	0.500/0.020

OBSOLETE - PART DISCONTINUED

OBSOLETE

**IMPORTANT NOTICE**

DIODES INCORPORATED MAKES NO WARRANTY OF ANY KIND, EXPRESS OR IMPLIED, WITH REGARDS TO THIS DOCUMENT, INCLUDING, BUT NOT LIMITED TO, THE IMPLIED WARRANTIES OF MERCHANTABILITY AND FITNESS FOR A PARTICULAR PURPOSE (AND THEIR EQUIVALENTS UNDER THE LAWS OF ANY JURISDICTION).

Diodes Incorporated and its subsidiaries reserve the right to make modifications, enhancements, improvements, corrections or other changes without further notice to this document and any product described herein. Diodes Incorporated does not assume any liability arising out of the application or use of this document or any product described herein; neither does Diodes Incorporated convey any license under its patent or trademark rights, nor the rights of others. Any Customer or user of this document or products described herein in such applications shall assume all risks of such use and will agree to hold Diodes Incorporated and all the companies whose products are represented on Diodes Incorporated website, harmless against all damages.

Diodes Incorporated does not warrant or accept any liability whatsoever in respect of any products purchased through unauthorized sales channel. Should Customers purchase or use Diodes Incorporated products for any unintended or unauthorized application, Customers shall indemnify and hold Diodes Incorporated and its representatives harmless against all claims, damages, expenses, and attorney fees arising out of, directly or indirectly, any claim of personal injury or death associated with such unintended or unauthorized application.

Products described herein may be covered by one or more United States, international or foreign patents pending. Product names and markings noted herein may also be covered by one or more United States, international or foreign trademarks.

This document is written in English but may be translated into multiple languages for reference. Only the English version of this document is the final and determinative format released by Diodes Incorporated.

**LIFE SUPPORT**

Diodes Incorporated products are specifically not authorized for use as critical components in life support devices or systems without the express written approval of the Chief Executive Officer of Diodes Incorporated. As used herein:

A. Life support devices or systems are devices or systems which:

1. are intended to implant into the body, or
2. support or sustain life and whose failure to perform when properly used in accordance with instructions for use provided in the labeling can be reasonably expected to result in significant injury to the user.

B. A critical component is any component in a life support device or system whose failure to perform can be reasonably expected to cause the failure of the life support device or to affect its safety or effectiveness.

Customers represent that they have all necessary expertise in the safety and regulatory ramifications of their life support devices or systems, and acknowledge and agree that they are solely responsible for all legal, regulatory and safety-related requirements concerning their products and any use of Diodes Incorporated products in such safety-critical, life support devices or systems, notwithstanding any devices- or systems-related information or support that may be provided by Diodes Incorporated. Further, Customers must fully indemnify Diodes Incorporated and its representatives against any damages arising out of the use of Diodes Incorporated products in such safety-critical, life support devices or systems.

Copyright © 2019, Diodes Incorporated

[www.diodes.com](http://www.diodes.com)

## Looking for pricing, stock, or lifecycle information?

Click below to explore more details on WIN SOURCE:

 [View AUR9716AGD on WIN SOURCE](#)

 [Diodes Incorporated Information](#)

## Optimize Your Supply Chain with WIN SOURCE Solutions

-  Global Sourcing Solution
-  Obsolete Management
-  Cost Control Management
-  Shortage Management
-  Alternative Solution
-  Excess Inventory Management