



**THE DATASHEET OF
MDF7-25S-2.54DSA(55)**



2.54mm Pitch Bottom Entry Type Connector

MDF7 Series

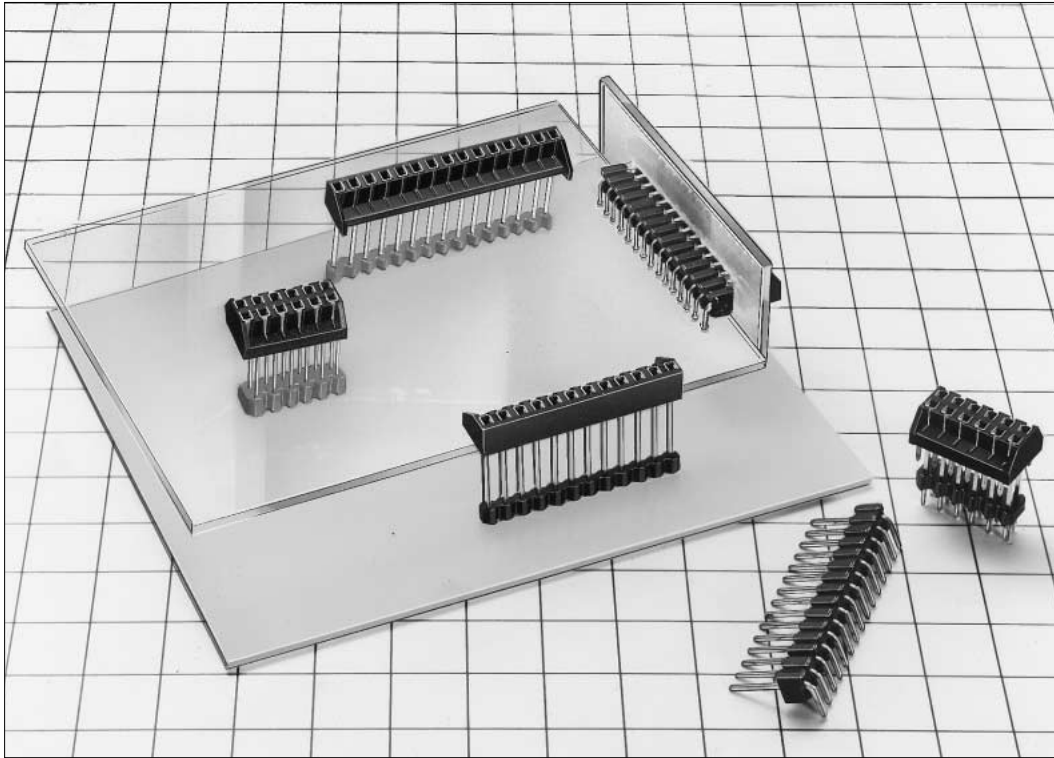

■ Features

1. Board to Board Size Freely Settable

The board to board size can be set at infinite stages, according to the header pin through type structure and the diverse header variation. The board to board size can be set at infinite stages.

2. Integrity of Parts Mounted Surface

The parts mounted surface on two boards aren't face each other, and can be oriented in the same direction.

3. Wide Variation

Single-row product, double-row product, tin plating and gold plating products are lined up. In addition, the header to correspond to the board to board size are prepared. Concerning board to board size, other products can be provided, in addition to products in this catalog. Please contact HRS company as required.

■ Applications

Internal connection of telephone sets and OA/FA equipment, connection between IPM, IGBT and the board.

Board to Board size Freely settable

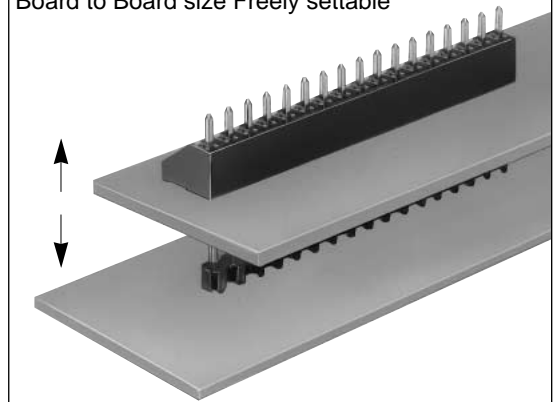

■Product Specifications

Rating	Current rating: 3A Voltage rating: 250V AC	Operating Temperature Range: -30°C to +85°C(Note 1) Operating Humidity Range: 40% to 70%	Storage Temperature Range: -10°C to +60°C (Note 2) Storage Humidity Range: 40% to 70%(Note 2)
--------	---	---	--

Item	Specification	Condition
1. Insulation Resistance	1000M ohms min.	500V DC
2. Withstanding voltage	No flashover or insulation breakdown.	650V AC/1 minute
3. Contact Resistance	30m ohms max.	100mA
4. Single Insertion/Extraction Force	MIN 0.4N(40gf), MAX 4.4N(450gf)	Measured by the square steel pin with 0.635±0.002mm
5. Vibration	No electrical discontinuity of 1μs or more	Frequency: 10 to 55 Hz, single amplitude of 0.75 mm, 2 hours in each of the 3 directions.
6. Humidity (Steady state)	Contact resistance: 30m ohms max. Insulation resistance: 500M ohms min.	96 hours at temperature of 40°C and humidity of 90% to 95%
7. Temperature Cycle	Contact resistance: 30m ohms max. Insulation resistance: 1000M ohms min.	(-55°C: 30 minutes, 5 to 35°C: 10 minutes 85°C: 30 minutes, 5 to 35°C: 10 minutes) 5cycles
8. Operating Life	Contact resistance: 30m ohms max.	Tin plating : 30 cycles Gold plating : 50 cycles
9. Resistance to Soldering heat	No deformation of components affecting performance.	Flow: 250°C for 10 seconds Manual soldering: 300°C for 3 seconds

Note 1: Includes temperature rise caused by current flow.

Note 2: The term "storage" refers to products stored for long period of time prior to mounting and use. Operating Temperature Range and Humidity range covers non conducting condition of installed connectors in storage, shipment or during transportation.

■Material

Product	Part	Material	Finish	Remarks
Receptacle	Insulator	Polyamide	Black	UL94V-0
	Contact	Phosphor bronze	Tin plating or gold plating	————
Pin Header	Insulator	PBT	Main unit: Black/Locator: Gray	UL94V-0
	Contact	Brass	Tin plating or gold plating	————

■Ordering Information

MDF7 - * S - 2.54 DSA
 ① ② ③ ④ ⑤

① Series Name : MDF7	④ Contact Pitch : 2.54mm
② Number of contacts : 3 to 46	⑤ Contact type DSA: Straight Dip DS : Right Angle Dip
③ Connector Type S : Single row receptacle D : Double row receptacle P : Single row pin header DP: Double row pin header	

Single Row Receptacle

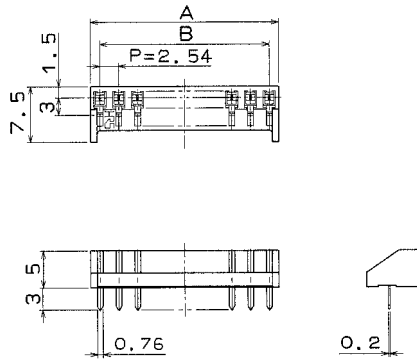
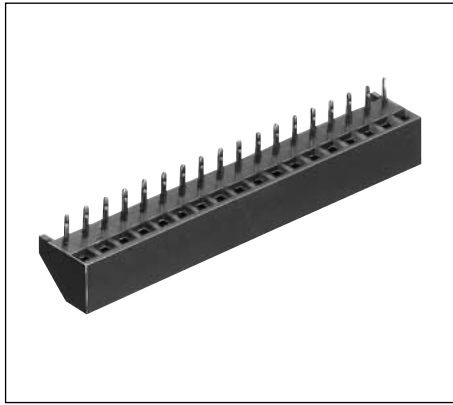

[Specific No.] -* *, (* *)
 None :Tin plating
 (01) :Gold plating

Unit: mm

Part Number	CL No.	Number of Contacts	A	B	Part Number	CL No.	Number of Contacts	A	B
MDF7- 3S-2.54DSA(**)	547-0355-0**	3	7.62	5.08	MDF7-15S-2.54DSA(**)	547-0012-4**	15	38.1	35.56
MDF7- 5S-2.54DSA(**)	547-0112-9**	5	12.7	10.16	MDF7-16S-2.54DSA(**)	547-0141-7**	16	40.64	38.1
MDF7- 6S-2.54DSA(**)	547-0129-1**	6	15.24	12.7	MDF7-17S-2.54DSA(**)	547-0142-0**	17	43.18	40.64
MDF7- 7S-2.54DSA(**)	547-0135-4**	7	17.78	15.24	MDF7-18S-2.54DSA(**)	547-0013-7**	18	45.72	43.18
MDF7- 8S-2.54DSA(**)	547-0136-7**	8	20.32	17.78	MDF7-19S-2.54DSA(**)	547-0143-2**	19	48.26	45.72
MDF7- 9S-2.54DSA(**)	547-0137-0**	9	22.86	20.32	MDF7-20S-2.54DSA(**)	547-0051-6**	20	50.8	48.26
MDF7-10S-2.54DSA(**)	547-0038-8**	10	25.4	22.86	MDF7-21S-2.54DSA(**)	547-0144-5**	21	53.34	50.8
MDF7-11S-2.54DSA(**)	547-0138-2**	11	27.94	25.4	MDF7-22S-2.54DSA(**)	547-0145-8**	22	55.88	53.34
MDF7-12S-2.54DSA(**)	547-0040-0**	12	30.48	27.94	MDF7-23S-2.54DSA(**)	547-0146-0**	23	58.42	55.88
MDF7-13S-2.54DSA(**)	547-0139-5**	13	33.02	30.48	MDF7-24S-2.54DSA(**)	547-0147-3**	24	60.96	58.42
MDF7-14S-2.54DSA(**)	547-0140-4**	14	35.56	33.02	MDF7-25S-2.54DSA(**)	547-0014-0**	25	63.5	60.96

Note: The quantity for delivery is determined per pack (100 pcs.). If needed, please order the products per pack.

Double Row Receptacle

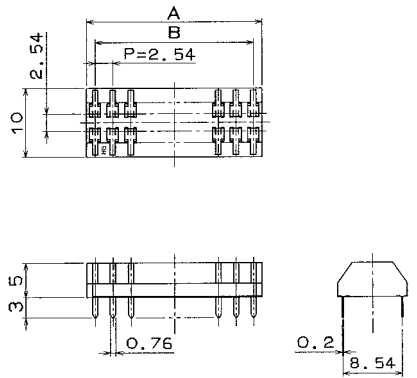
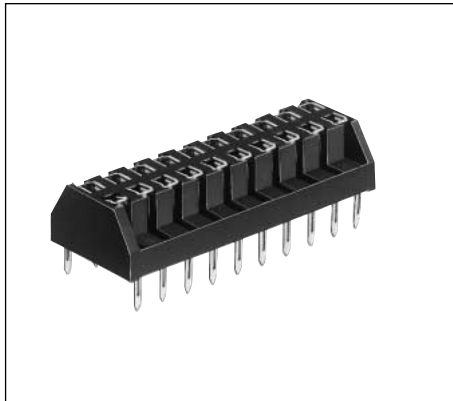

Unit: mm

Part Number	CL No.	Number of Contacts	A	B
MDF7-12D-2.54DSA(**)	547-0032-1**	12	15.24	12.7
MDF7-14D-2.54DSA(**)	547-0354-8**	14	17.78	15.24
MDF7-16D-2.54DSA(**)	547-0363-9**	16	20.32	17.78
MDF7-20D-2.54DSA(**)	547-0033-4**	20	25.4	22.86
MDF7-22D-2.54DSA(**)	547-0246-5**	22	27.94	25.4
MDF7-24D-2.54DSA(**)	547-0244-0**	24	30.48	27.94
MDF7-26D-2.54DSA(**)	547-0247-8**	26	33.02	30.48
MDF7-30D-2.54DSA(**)	547-0016-5**	30	38.1	35.56
MDF7-34D-2.54DSA(**)	547-0227-0**	34	43.18	40.64
MDF7-40D-2.54DSA(**)	547-0228-3**	40	50.8	48.26
MDF7-46D-2.54DSA(**)	547-0229-6**	46	58.42	55.88

[Specific No.] -* *, (* *) (Note 2)
 None :Gold plating
 (01) :Tin plating

Note 1: A quantity for delivery is determined per pack (100 pcs.). If needed, please order the products per pack.

Note 2: The MDF7 series 2-row plating specification is different from the single-row plating specification.

No-specification indicates the gold plating, and (01) indicates the tin plating.

Single Row Straight Pin Header

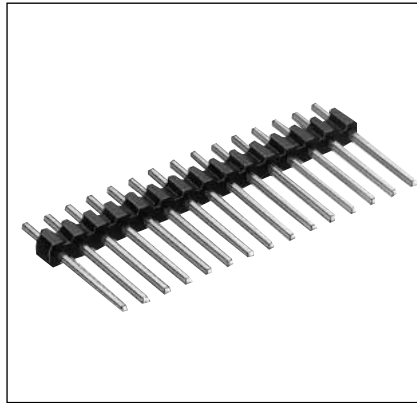

●Board Through-hole Diameter: $\phi 1.0^{+0.1}$

[Specific No.] - * *, (* *)
 None : Tin plating
 (01) : Gold plating

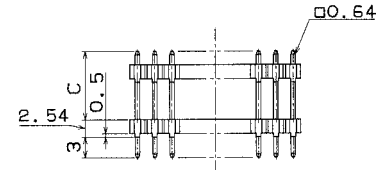
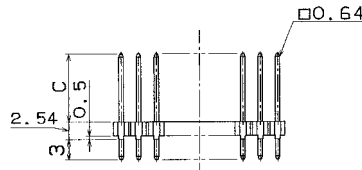
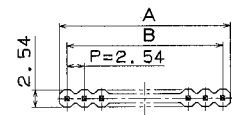
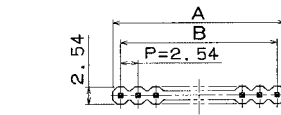

[without locator]

[with locator]

●MDF7(Board to Board Size: 2.54 to 5.5mm)

●MDF7B (Board to Board Size 2.54 to 12mm)

Unit: mm

Part Number	CL No.	Number of Contacts	A	B	C	Part Number	CL No.	Number of Contacts	A	B	C
MDF7- 3P-2.54DSA(**)	547-0220-1-**	3	7.62	5.08	10	MDF7B- 3P-2.54DSA(**)	547-0304-0-**	3	7.62	5.08	16.46
MDF7- 5P-2.54DSA(**)	547-0113-1-**	5	12.7	10.16	10	MDF7B- 5P-2.54DSA(**)	547-0133-9-**	5	12.7	10.16	16.46
MDF7- 6P-2.54DSA(**)	547-0130-0-**	6	15.24	12.7	10	MDF7B- 6P-2.54DSA(**)	547-0131-3-**	6	15.24	12.7	16.46
MDF7- 7P-2.54DSA(**)	547-0148-6-**	7	17.78	15.24	10	MDF7B- 7P-2.54DSA(**)	547-0177-4-**	7	17.78	15.24	16.46
MDF7- 8P-2.54DSA(**)	547-0149-9-**	8	20.32	17.78	10	MDF7B- 8P-2.54DSA(**)	547-0178-7-**	8	20.32	17.78	16.46
MDF7- 9P-2.54DSA(**)	547-0150-8-**	9	22.86	20.32	10	MDF7B- 9P-2.54DSA(**)	547-0179-0-**	9	22.86	20.32	16.46
MDF7-10P-2.54DSA(**)	547-0039-0-**	10	25.4	22.86	10	MDF7B-10P-2.54DSA(**)	547-0048-1-**	10	25.4	22.86	16.46
MDF7-11P-2.54DSA(**)	547-0151-0-**	11	27.94	25.4	10	MDF7B-11P-2.54DSA(**)	547-0047-9-**	11	27.94	25.4	16.46
MDF7-12P-2.54DSA(**)	547-0043-8-**	12	30.48	27.94	10	MDF7B-12P-2.54DSA(**)	547-0041-2-**	12	30.48	27.94	16.46
MDF7-13P-2.54DSA(**)	547-0152-3-**	13	33.02	30.48	10	MDF7B-13P-2.54DSA(**)	547-0180-9-**	13	33.02	30.48	16.46
MDF7-14P-2.54DSA(**)	547-0153-6-**	14	35.56	33.02	10	MDF7B-14P-2.54DSA(**)	547-0181-1-**	14	35.56	33.02	16.46
MDF7-15P-2.54DSA(**)	547-0018-0-**	15	38.1	35.56	10	MDF7B-15P-2.54DSA(**)	547-0024-3-**	15	38.1	35.56	16.46
MDF7-16P-2.54DSA(**)	547-0111-6-**	16	40.64	38.1	10	MDF7B-16P-2.54DSA(**)	547-0182-4-**	16	40.64	38.1	16.46
MDF7-17P-2.54DSA(**)	547-0154-9-**	17	43.18	40.64	10	MDF7B-17P-2.54DSA(**)	547-0183-7-**	17	43.18	40.64	16.46
MDF7-18P-2.54DSA(**)	547-0022-8-**	18	45.72	43.18	10	MDF7B-18P-2.54DSA(**)	547-0025-6-**	18	45.72	43.18	16.46
MDF7-19P-2.54DSA(**)	547-0155-1-**	19	48.26	45.72	10	MDF7B-19P-2.54DSA(**)	547-0184-0-**	19	48.26	45.72	16.46
MDF7-20P-2.54DSA(**)	547-0123-5-**	20	50.8	48.26	10	MDF7B-20P-2.54DSA(**)	547-0052-9-**	20	50.8	48.26	16.46
MDF7-21P-2.54DSA(**)	547-0156-4-**	21	53.34	50.8	10	MDF7B-21P-2.54DSA(**)	547-0185-2-**	21	53.34	50.8	16.46
MDF7-22P-2.54DSA(**)	547-0157-7-**	22	55.88	53.34	10	MDF7B-22P-2.54DSA(**)	547-0186-5-**	22	55.88	53.34	16.46
MDF7-23P-2.54DSA(**)	547-0158-0-**	23	58.42	55.88	10	MDF7B-23P-2.54DSA(**)	547-0066-3-**	23	58.42	55.88	16.46
MDF7-24P-2.54DSA(**)	547-0159-2-**	24	60.96	58.42	10	MDF7B-24P-2.54DSA(**)	547-0067-6-**	24	60.96	58.42	16.46
MDF7-25P-2.54DSA(**)	547-0023-0-**	25	63.5	60.96	10	MDF7B-25P-2.54DSA(**)	547-0026-9-**	25	63.5	60.96	16.46

Note 1: The board to board size in the above table represents the case where the 1.6mm thickness board is used.

Note 2: The quantity for delivery is determined per pack (100 pcs.). If needed, please order the products per pack.

●MDF7P (Board to Board Size 2.54 to 8mm)

●MDF7C (Board to Board Size 5.08 to 15mm,with Locator)

Unit: mm

Unit: mm

Part Number	CL No.	Number of Contacts	A	B	C	Part Number	CL No.	Number of Contacts	A	B	C
MDF7P- 3P-2.54DSA(**)	————	3	7.62	5.08	12.5	MDF7C- 3P-2.54DSA(**)	————	3	7.62	5.08	19.46
MDF7P- 5P-2.54DSA(**)	————	5	12.7	10.16	12.5	MDF7C- 5P-2.54DSA(**)	547-0344-4-**	5	12.7	10.16	19.46
MDF7P- 6P-2.54DSA(**)	————	6	15.24	12.7	12.5	MDF7C- 6P-2.54DSA(**)	547-0268-8-**	6	15.24	12.7	19.46
MDF7P- 7P-2.54DSA(**)	————	7	17.78	15.24	12.5	MDF7C- 7P-2.54DSA(**)	547-0378-6-**	7	17.78	15.24	19.46
MDF7P- 8P-2.54DSA(**)	————	8	20.32	17.78	12.5	MDF7C- 8P-2.54DSA(**)	547-0375-8-**	8	20.32	17.78	19.46
MDF7P- 9P-2.54DSA(**)	————	9	22.86	20.32	12.5	MDF7C- 9P-2.54DSA(**)	————	9	22.86	20.32	19.46
MDF7P-10P-2.54DSA(**)	547-0360-0-**	10	25.4	22.86	12.5	MDF7C-10P-2.54DSA(**)	————	10	25.4	22.86	19.46
MDF7P-11P-2.54DSA(**)	————	11	27.94	25.4	12.5	MDF7C-11P-2.54DSA(**)	547-0376-0-**	11	27.97	25.4	19.46
MDF7P-12P-2.54DSA(**)	547-0345-7-**	12	30.48	27.94	12.5	MDF7C-12P-2.54DSA(**)	————	12	30.48	27.94	19.46
MDF7P-13P-2.54DSA(**)	————	13	33.02	30.48	12.5	MDF7C-13P-2.54DSA(**)	547-0401-6-**	13	33.02	30.48	19.46
MDF7P-14P-2.54DSA(**)	547-0385-1-**	14	35.56	33.02	12.5	MDF7C-14P-2.54DSA(**)	547-0380-8-**	14	35.56	33.02	19.46
MDF7P-15P-2.54DSA(**)	547-0230-5-**	15	38.1	35.56	12.5	MDF7C-15P-2.54DSA(**)	————	15	38.1	35.56	19.46
MDF7P-16P-2.54DSA(**)	547-0346-0-**	16	40.64	38.1	12.5	MDF7C-16P-2.54DSA(**)	————	16	40.64	38.1	19.46
MDF7P-17P-2.54DSA(**)	————	17	43.18	40.46	12.5	MDF7C-17P-2.54DSA(**)	————	17	43.18	40.64	19.46
MDF7P-18P-2.54DSA(**)	————	18	45.72	43.18	12.5	MDF7C-18P-2.54DSA(**)	547-0029-7-**	18	45.72	43.18	19.46
MDF7P-19P-2.54DSA(**)	547-0347-2-**	19	48.26	45.72	12.5	MDF7C-19P-2.54DSA(**)	547-0361-3-**	19	48.26	45.72	19.46
MDF7P-20P-2.54DSA(**)	————	20	50.8	48.26	12.5	MDF7C-20P-2.54DSA(**)	547-0198-4-**	20	50.8	48.26	19.46
MDF7P-21P-2.54DSA(**)	————	21	53.34	50.8	12.5	MDF7C-21P-2.54DSA(**)	————	21	53.34	50.8	19.46
MDF7P-22P-2.54DSA(**)	————	22	55.88	53.34	12.5	MDF7C-22P-2.54DSA(**)	————	22	55.88	53.34	19.46
MDF7P-23P-2.54DSA(**)	————	23	58.42	55.88	12.5	MDF7C-23P-2.54DSA(**)	————	23	58.42	55.88	19.46
MDF7P-24P-2.54DSA(**)	————	24	60.96	58.42	12.5	MDF7C-24P-2.54DSA(**)	————	24	60.96	58.42	19.46
MDF7P-25P-2.54DSA(**)	547-0348-5-**	25	63.5	60.96	12.5	MDF7C-25P-2.54DSA(**)	547-0305-2-**	25	63.5	60.96	19.46

Note 1: The board to board size in the above table represents the case where the 1.6mm thickness board is used.

Note 2: A quantity for delivery is determined per pack (100 pcs.). If needed, please order the products per pack.

Note 3: As for the products, which HRS No. is not indicated in the above table, we will correspond to samples, and mass-production according to your demand. Please contact HRS company, as required.

Single-Row Right Angle Pin Header

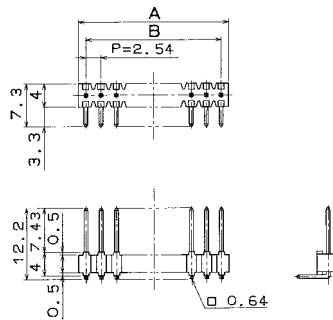
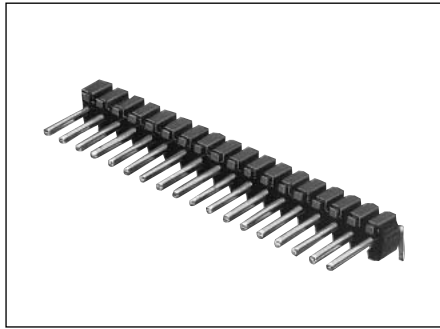

●Board Through-hole Diameter: $\phi 1.0^{+0.1}$

[Specific No.] -** , (**)
 None :Tin plating
 (01) :Gold plating

Unit: mm

Part Number	CL No.	Number of Contacts	A	B	Part Number	CL No.	Number of Contacts	A	B
MDF7- 5P-2.54DS(**)	547-0160-1-**	5	12.7	10.16	MDF7-16P-2.54DS(**)	547-0169-6-**	16	40.64	38.1
MDF7- 6P-2.54DS(**)	547-0161-4-**	6	15.24	12.7	MDF7-17P-2.54DS(**)	547-0170-5-**	17	43.18	40.64
MDF7- 7P-2.54DS(**)	547-0162-7-**	7	17.78	15.24	MDF7-18P-2.54DS(**)	547-0019-3-**	18	45.72	43.18
MDF7- 8P-2.54DS(**)	547-0163-0-**	8	20.32	17.78	MDF7-19P-2.54DS(**)	547-0171-8-**	19	48.26	45.72
MDF7- 9P-2.54DS(**)	547-0164-2-**	9	22.86	20.32	MDF7-20P-2.54DS(**)	547-0172-0-**	20	50.8	48.26
MDF7-10P-2.54DS(**)	547-0165-5-**	10	25.4	22.86	MDF7-21P-2.54DS(**)	547-0173-3-**	21	53.34	50.8
MDF7-11P-2.54DS(**)	547-0166-8-**	11	27.94	25.4	MDF7-22P-2.54DS(**)	547-0174-6-**	22	55.88	53.34
MDF7-12P-2.54DS(**)	547-0116-0-**	12	30.48	27.94	MDF7-23P-2.54DS(**)	547-0175-9-**	23	58.42	55.88
MDF7-13P-2.54DS(**)	547-0167-0-**	13	33.02	30.48	MDF7-24P-2.54DS(**)	547-0176-1-**	24	60.96	58.42
MDF7-14P-2.54DS(**)	547-0168-3-**	14	35.56	33.02	MDF7-25P-2.54DS(**)	547-0028-4-**	25	63.5	60.96
MDF7-15P-2.54DS(**)	547-0027-1-**	15	38.1	35.56					

Note: A quantity for delivery is determined per pack (100 pcs.). If needed, please order the products per pack.

Application Pattern and PCB mounting pattern

●When the single-row straight pin header is used

●When the header with locator is used

The locator moves as the connector is inserted.

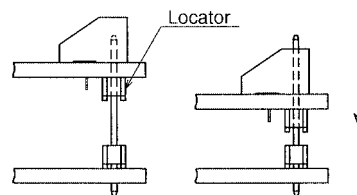
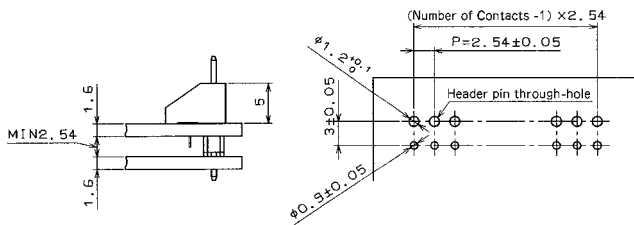

●When the board to board size is set to MAX

●When the right angle pin header is used

To separate clearance between the boards, the operation limit t is defined as the state where the male pin has passed through the receptacle.

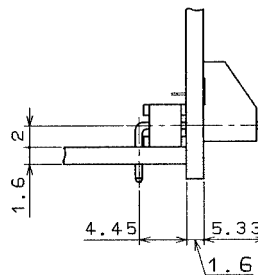
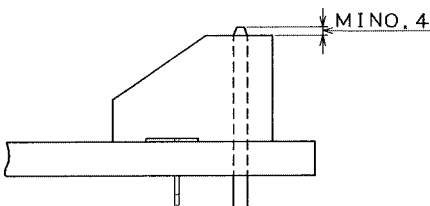

Double-Row Straight Pin Header

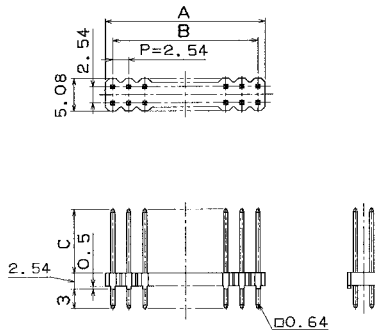
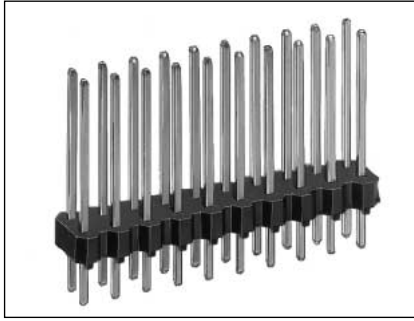

●Board Through-hole Diameter: $\phi 1.0^{+0.1}$

[Specific No.] -* *, (* *)
None :Gold plating
(01) :Tin plating

●MDF7 (Board to Board Size: 2.54 to 5.5mm)

●MDF7P (Board to Board Size: 2.54 to 8mm)

Unit: mm						Unit: mm					
Part Number	CL No.	Number of Contacts	A	B	C	Part Number	CL No.	Number of Contacts	A	B	C
MDF7-12DP-2.54DSA(**)	547-0034-7-**	12	15.24	12.7	10	MDF7P-12DP-2.54DSA(**)	547-0407-2-**	12	15.24	12.7	12.5
MDF7-14DP-2.54DSA(**)	547-0365-4-**	14	17.78	15.24	10	MDF7P-14DP-2.54DSA(**)	—	14	17.78	15.24	12.5
MDF7-16DP-2.54DSA(**)	547-0364-1-**	16	20.32	17.78	10	MDF7P-16DP-2.54DSA(**)	547-0367-0-**	16	20.32	17.78	12.5
MDF7-20DP-2.54DSA(**)	547-0114-4-**	20	25.4	22.86	10	MDF7P-20DP-2.54DSA(**)	547-0260-6-**	20	25.4	22.86	12.5
MDF7-22DP-2.54DSA(**)	547-0093-6-**	22	27.94	25.4	10	MDF7P-22DP-2.54DSA(**)	547-0261-9-**	22	27.94	25.4	12.5
MDF7-24DP-2.54DSA(**)	547-0250-2-**	24	30.48	27.94	10	MDF7P-24DP-2.54DSA(**)	547-0262-1-**	24	30.48	27.94	12.5
MDF7-26DP-2.54DSA(**)	547-0251-5-**	26	33.02	30.48	10	MDF7P-26DP-2.54DSA(**)	547-0263-4-**	26	33.02	30.48	12.5
MDF7-30DP-2.54DSA(**)	547-0037-5-**	30	38.1	35.56	10	MDF7P-30DP-2.54DSA(**)	547-0264-7-**	30	38.1	35.56	12.5
MDF7-34DP-2.54DSA(**)	547-0252-8-**	34	43.18	40.64	10	MDF7P-34DP-2.54DSA(**)	—	34	43.18	40.64	12.5
MDF7-40DP-2.54DSA(**)	547-0253-0-**	40	50.8	48.26	10	MDF7P-40DP-2.54DSA(**)	—	40	50.8	48.26	12.5
MDF7-46DP-2.54DSA(**)	547-0254-3-**	46	58.42	55.88	10	MDF7P-46DP-2.54DSA(**)	—	46	58.42	55.88	12.5

Note 1: The board to board size in the above table represents the state where the 1.6mm thickness board is used.

Note 2: A quantity for delivery is determined per pack (100 pcs.). If needed, please order the products per pack.

Note 3: The MDF7 series 2-row plating specification is different from the single-row plating specification. No-specification indicates the gold plating, and (01) indicates the tin plating.

Note 4: As for the products, which HRS No. is not indicated in the above table, we will correspond to samples, and mass-production according to your demand. Please contact HRS company, as required.

Application Pattern and PCB mounting pattern

●When the double-row straight pin header is used

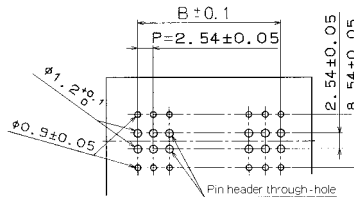
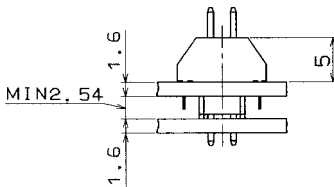

Precautions for Use

1. Recommended Soldering Condition	<p>■Flow Condition by Automatic Soldering Unit Soldering temperature: $250\pm 5^{\circ}\text{C}$, Soldering time: within 2 seconds</p> <p>■Manual Soldering Condition Soldering iron temperature: $290\pm 10^{\circ}\text{C}$, Soldering time: within 2 seconds</p>
2. Board Masking	<p>If the automatic soldering unit is used, block the pin header through-hole on the receptacle mounted board with the masking tape, etc., and prevent the flux pervasion.</p> <p>In addition, if much flux is adhered so as to affect the contact, please be sure to clean the board.</p>
3. Cleaning Condition	Refer to Nylon Connector Use Hand book.
4. Cautions	<p>■It is impossible to fix the board to the board by the connector only. Please take actions to fix the board without using the connector.</p> <p>■If the board deformation could occur due to vibration, please use the gold plating.</p> <p>■Don't use the connector as the top entry.</p>

Looking for pricing, stock, or lifecycle information?

Click below to explore more details on WIN SOURCE:

- ⊖ [View MDF7-25S-2.54DSA\(55\) on WIN SOURCE](#)
- ⊖ [Hirose Electric Co Ltd Information](#)

Optimize Your Supply Chain with WIN SOURCE Solutions

- ✓ Global Sourcing Solution
- ✓ Obsolete Management
- ✓ Cost Control Management
- ✓ Shortage Management
- ✓ Alternative Solution
- ✓ Excess Inventory Management