

High-Current Low Dropout Regulators

Features

- High Current Capability:
 - MIC29150/29151/29152/29153: 1.5A
 - MIC29300/29301/29302/29303: 3A
 - MIC29500/29501/29502/29503: 5A
 - MIC29751/29752: 7.5A
- Low Dropout Voltage
- Low Ground Current
- Accurate 1% Guaranteed Tolerance
- Extremely Fast Transient Response
- Reverse-Battery and “Load Dump” Protection
- Zero-Current Shutdown Mode (5-Pin Versions)
- Error Flag Signals Output Out-of-Regulation (5-Pin Versions)
- Also Characterized for Smaller Loads with Industry-Leading Performance Specifications
- Fixed-Voltage and Adjustable Versions

Applications

- Battery-Powered Equipment
- High-Efficiency Green Computer Systems
- Automotive Electronics
- High-Efficiency Linear Power Supplies
- High-Efficiency Post-Regulator for Switching Supply

General Description

The MIC2915x/2930x/2950x/2975x are high current, high accuracy, low dropout voltage regulators. Using Microchip’s proprietary Super β PNP process with a PNP pass element, these regulators feature 350 mV to 425 mV (full load) typical dropout voltages and very low ground current. Designed for high current loads, these devices also find applications in lower current, extremely low dropout-critical systems, where their tiny dropout voltage and ground current values are important attributes.

The MIC2915x/2930x/2950x/2975x are fully protected against overcurrent faults, reversed input polarity, reversed lead insertion, overtemperature operation, and positive and negative transient voltage spikes. Five pin fixed-voltage versions feature logic level ON/OFF control and an error flag that signals whenever the output falls out of regulation. Flagged states include low input voltage (dropout), output current limit, overtemperature shutdown, and extremely high voltage spikes on the input.

On the MIC29xx1 and MIC29xx2, the ENABLE pin may be tied to V_{IN} if it is not required for ON/OFF control. The MIC2915x/2930x/2950x are available in 3-pin and 5-pin TO-220 and surface mount TO-263 (D²Pak) packages. The MIC2975x 7.5A regulators are available in a 5-pin TO-247 package. The 1.5A, adjustable output MIC29152 is available in a 5-pin power D-Pak (TO-252) package.

For applications with input voltage 6V or below, see MIC37xxx LDOs.

Package Types



MIC2915X/30X/50X/75X

Package Types (Continued)

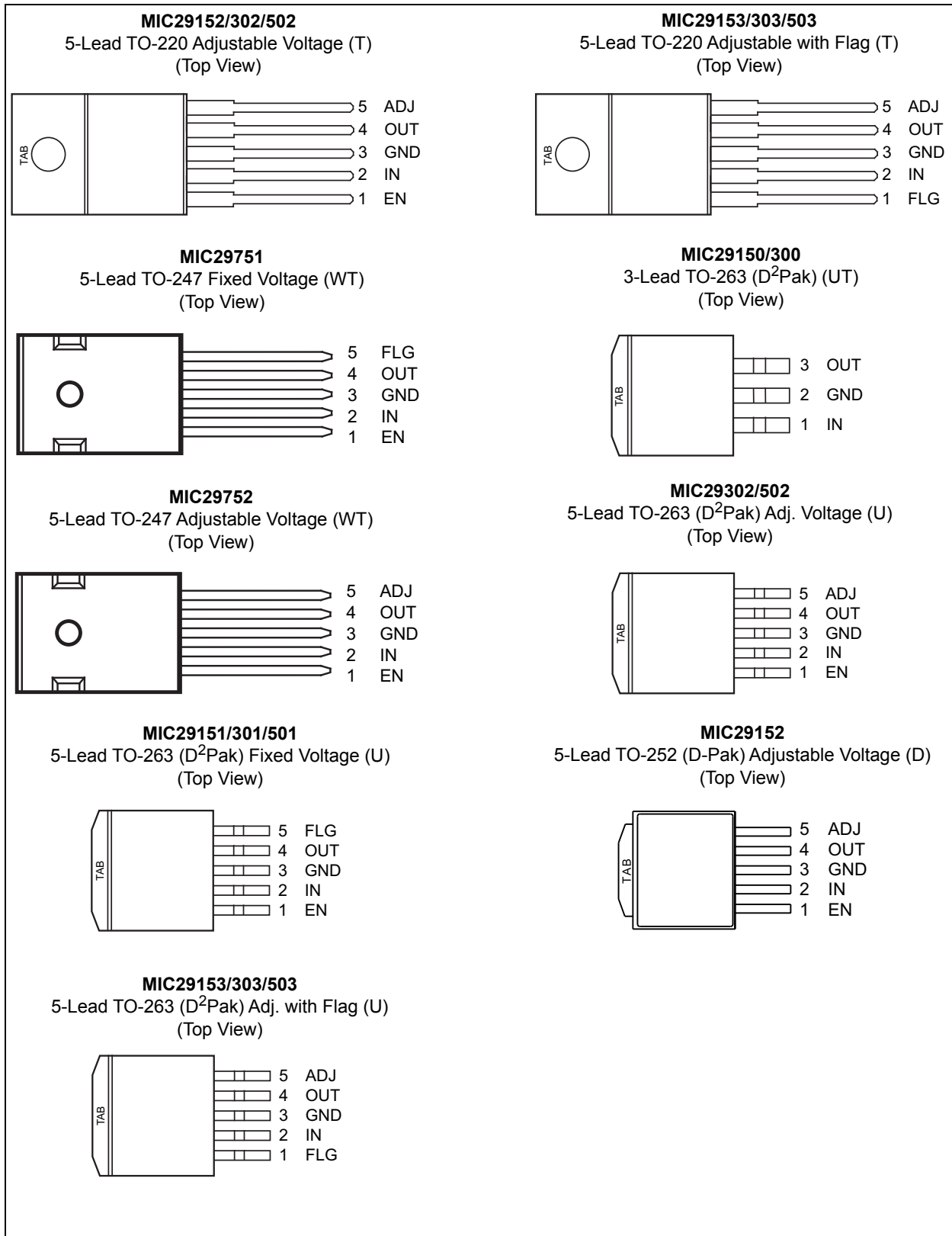

MIC2915X/30X/50X/75X

Typical Application Circuits



Functional Diagram



MIC2915X/30X/50X/75X

1.0 ELECTRICAL CHARACTERISTICS

Absolute Maximum Ratings † (Note 1)

Input Supply Voltage (V_{IN}) (Note 1).....	-20V to +60V
Enable Input Voltage (V_{EN})	-0.3V to V_{IN}
Power Dissipation.....	Internally Limited
ESD Rating	Note 2

Operating Ratings‡

Maximum Operating Input Voltage	+26V
---------------------------------------	------

† **Notice:** Stresses above those listed under “Absolute Maximum Ratings” may cause permanent damage to the device. This is a stress rating only and functional operation of the device at those or any other conditions above those indicated in the operational sections of this specification is not intended. Exposure to maximum rating conditions for extended periods may affect device reliability.

‡ **Notice:** The device is not guaranteed to function outside its operating ratings.

Note 1: Maximum positive supply voltage of 60V must be of limited duration (<100 ms) and duty cycle ($\leq 1\%$). The maximum continuous supply voltage is 26V. Exceeding the absolute maximum rating may damage the device.

2: Devices are ESD sensitive. Handling precautions recommended.

MIC2915X/30X/50X/75X

TABLE 1-1: ELECTRICAL CHARACTERISTICS (Note 1, Note 2)

Electrical Characteristics: $V_{IN} = V_{OUT} + 1V$; $I_{OUT} = 10\text{ mA}$; $T_J = +25^\circ\text{C}$. **Bold** values indicate $-40^\circ\text{C} \leq T_J \leq +125^\circ\text{C}$, unless noted.

Parameter	Symbol	Min.	Typ.	Max.	Units	Conditions
Output Voltage	V_{OUT}	-1	—	1	%	$I_{OUT} = 10\text{ mA}$
		-2	—	2		$10\text{ mA} \leq I_{OUT} \leq I_{FL}$, $(V_{OUT} + 1V) \leq V_{IN} \leq 26V$ (Note 3)
Line Regulation		—	0.06	0.5	%	$I_{OUT} = 10\text{ mA}$, $(V_{OUT} + 1V) \leq V_{IN} \leq 26V$
Load Regulation		—	0.2	1	%	$V_{IN} = V_{OUT} + 1V$, $10\text{ mA} \leq I_{OUT} \leq 1.5A$ (Note 3, Note 4)
$\Delta V_O/\Delta T$		—	20	100	ppm/ $^\circ\text{C}$	Output Voltage (Note 4) Temperature Coefficient
Dropout Voltage $\Delta V_{OUT} = -1\%$ (Note 5)		—	80	200	mV	MIC2915x $I_{OUT} = 100\text{ mA}$
		—	220	—		MIC2915x $I_{OUT} = 750\text{ mA}$
		—	350	600		MIC2915x $I_{OUT} = 1.5A$
		—	80	175		MIC2930x $I_{OUT} = 100\text{ mA}$
		—	250	—		MIC2930x $I_{OUT} = 1.5A$
		—	370	600		MIC2930x $I_{OUT} = 3A$
		—	125	250		MIC2950x $I_{OUT} = 250\text{ mA}$
		—	250	—		MIC2950x $I_{OUT} = 2.5A$
		—	370	600		MIC2950x $I_{OUT} = 5A$
		—	80	200		MIC2975x $I_{OUT} = 250\text{ mA}$
		—	270	—		MIC2975x $I_{OUT} = 4A$
		—	425	750		MIC2975x $I_{OUT} = 7.5A$
Ground Current (Note 6)	I_{GND}	—	8	20	mA	MIC2915x $I_{OUT} = 750\text{ mA}$, $V_{IN} = V_{OUT} + 1V$
		—	22	—		MIC2915x $I_{OUT} = 1.5A$
		—	10	35		MIC2930x $I_{OUT} = 1.5A$, $V_{IN} = V_{OUT} + 1V$
		—	37	—		MIC2930x $I_{OUT} = 3A$
		—	15	50		MIC2950x $I_{OUT} = 2.5A$, $V_{IN} = V_{OUT} + 1V$
		—	70	—		MIC2950x $I_{OUT} = 5A$
		—	35	75		MIC2975x $I_{OUT} = 4A$, $V_{IN} = V_{OUT} + 1V$
		—	120	—		MIC2975x $I_{OUT} = 7.5A$
Ground Pin Current at Dropout	I_{GRNDDO}	—	0.9	—	mA	MIC2915x, $V_{IN} = 0.5V$ less than specified $V_{OUT} \times I_{OUT} = 10\text{ mA}$
		—	1.7	—		MIC2930x, $V_{IN} = 0.5V$ less than specified $V_{OUT} \times I_{OUT} = 10\text{ mA}$
		—	2.1	—		MIC2950x, $V_{IN} = 0.5V$ less than specified $V_{OUT} \times I_{OUT} = 10\text{ mA}$
		—	3.1	—		MIC2975x, $V_{IN} = 0.5V$ less than specified $V_{OUT} \times I_{OUT} = 10\text{ mA}$
Current Limit	I_{LIM}	—	2.1	3.5	A	MIC2915x, $V_{OUT} = 0V$, (Note 7)
		—	4.5	5.0		MIC2930x, $V_{OUT} = 0V$, (Note 7)
		—	7.5	10.0		MIC2950x, $V_{OUT} = 0V$, (Note 7)
		—	9.5	15.0		MIC2975x, $V_{OUT} = 0V$, (Note 7)

MIC2915X/30X/50X/75X

TABLE 1-1: ELECTRICAL CHARACTERISTICS (Note 1, Note 2) (CONTINUED)

Electrical Characteristics: $V_{IN} = V_{OUT} + 1V$; $I_{OUT} = 10\text{ mA}$; $T_J = +25^\circ\text{C}$. **Bold** values indicate $-40^\circ\text{C} \leq T_J \leq +125^\circ\text{C}$, unless noted.

Parameter	Symbol	Min.	Typ.	Max.	Units	Conditions
e_n , Output Noise Voltage (10 Hz to 100 kHz) $I_L = 100\text{ mA}$		—	400	—	μV_{RMS}	$C_L = 10\text{ }\mu\text{F}$
		—	260	—		$C_L = 33\text{ }\mu\text{F}$
Ground Current in Shutdown		—	2	10	μA	MIC29150/1/2/3 only
		—	—	30		$V_{\text{EN}} = 0.4\text{V}$
Reference - MIC29xx2/MIC29xx3						
Reference Voltage		1.228	1.240	1.252	V	—
		1.215	—	1.265	V_{MAX}	
Reference Voltage		1.203	—	1.277	V	Note 8
Adjust Pin Bias Current		—	40	80	nA	—
		—	—	120		
Reference Voltage Temperature Coefficient		—	20	—	ppm/°C	Note 9
Adjust Pin Bias Current Temperature Coefficient		—	0.1	—	nA/°C	—
Flag Output (Error Comparator) - MIC29xx1/29xx3						
Output Leakage Current		—	0.01	1.00	μA	$V_{\text{OH}} = 26\text{V}$
		—	—	2.00		
Output Low Voltage	V_{OL}	—	220	300	mV	Device set for 5V, $V_{\text{IN}} = 4.5\text{V}$ $I_{\text{OL}} = 250\text{ }\mu\text{A}$
		—	—	400		
Upper Threshold Voltage		40	60	—	mV	Device set for 5V, (Note 10)
		25	—	—		
Lower Threshold Voltage		—	75	95	mV	Device set for 5V, (Note 10)
		—	—	140		
Hysteresis		—	15	—	mV	Device set for 5V, (Note 10)

MIC2915X/30X/50X/75X

TABLE 1-1: ELECTRICAL CHARACTERISTICS (Note 1, Note 2) (CONTINUED)

Electrical Characteristics: $V_{IN} = V_{OUT} + 1V$; $I_{OUT} = 10\text{ mA}$; $T_J = +25^\circ\text{C}$. **Bold** values indicate $-40^\circ\text{C} \leq T_J \leq +125^\circ\text{C}$, unless noted.

Parameter	Symbol	Min.	Typ.	Max.	Units	Conditions
ENABLE Input - MIC29xx1/MIC29xx2						
Input Logic Voltage Low (OFF)		—	—	0.8	V	—
Input Logic Voltage High (ON)		2.4	—	—	V	—
Enable Pin Input Current		—	100	600	μA	$V_{EN} = 26V$
		—	—	750		
		0.7	—	2		$V_{EN} = 0.8V$
		—	—	4		
Regulator Output Current in Shutdown		—	10	500	μA	$V_{EN} \leq 0.8V$ and $V_{IN} \leq 26V$, $V_{OUT} = 0$.

Note 1: Specification for packaged product only.

- 2:** When used in dual supply systems where the regulator load is returned to a negative supply, the output voltage must be diode clamped to ground.
- 3:** Full load current (I_{FL}) is defined as 1.5A for the MIC2915x, 3A for the MIC2930x, 5A for the MIC2950x, and 7.5A for the MIC2975x families.
- 4:** Output voltage temperature coefficient is defined as the worst case voltage change divided by the total temperature range.
- 5:** Dropout voltage is defined as the input-to-output differential when the output voltage drops to 99% of its normal value with $V_{OUT} + 1V$ applied to V_{IN} .
- 6:** Ground pin current is the regulator quiescent current. The total current drawn from the source is the sum of the load current plus the ground pin current.
- 7:** $V_{IN} = V_{OUT} (\text{nominal}) + 1V$. For example, use $V_{IN} = 4.3V$ for a 3.3V regulator or use 6V for a 5V regulator. Employ pulse-testing procedures to pin current.
- 8:** $V_{REF} \leq V_{OUT} \leq (V_{IN} - 1V)$, $2.3V \leq V_{IN} \leq 26V$, $10\text{ mA} < I_L \leq I_{FL}$, $T_J \leq T_{JMAX}$.
- 9:** Thermal regulation is defined as the change in output voltage at a time T after a change in power dissipation is applied, excluding load or line regulation effects. Specifications are for a 200 mA load pulse at $V_{IN} = 20V$ (a 4W pulse) for $T = 10\text{ ms}$.
- 10:** Comparator thresholds are expressed in terms of a voltage differential at the adjust terminal below the nominal reference voltage measured at 6V input. To express these thresholds in terms of output voltage change, multiply by the error amplifier gain = $V_{OUT}/V_{REF} = (R1 + R2)/R2$. For example, at a programmed output voltage of 5V, the error output is guaranteed to go low when the output drops by $95\text{ mV} \times 5V/1.240V = 384\text{ mV}$. Thresholds remain constant as a percent of V_{OUT} as V_{OUT} is varied, with the dropout warning occurring at typically 5% below nominal, 7.7% guaranteed.

MIC2915X/30X/50X/75X

TEMPERATURE SPECIFICATIONS (Note 1)

Parameters	Sym.	Min.	Typ.	Max.	Units	Conditions
Temperature Ranges						
Storage Temperature Range	T_S	-65	—	+150	°C	—
Operating Junction Temperature	T_J	-40	—	+125	°C	—
Lead Temperature	—	—	—	+260	°C	Soldering, 5 sec.
Package Thermal Resistance						
Thermal Resistance TO-220	θ_{JC}	—	2	—	°C/W	—
Thermal Resistance TO-263	θ_{JC}	—	2	—	°C/W	—
Thermal Resistance TO-247	θ_{JC}	—	1.5	—	°C/W	—
Thermal Resistance TO-252	θ_{JC}	—	3	—	°C/W	—
Thermal Resistance TO-252	θ_{JA}	—	56	—	°C/W	—

Note 1: The maximum allowable power dissipation is a function of ambient temperature, the maximum allowable junction temperature and the thermal resistance from junction to air (i.e., T_A , T_J , θ_{JA}). Exceeding the maximum allowable power dissipation will cause the device operating junction temperature to exceed the maximum +125°C rating. Sustained junction temperatures above +125°C can impact the device reliability.

2.0 TYPICAL PERFORMANCE CURVES

Note: The graphs and tables provided following this note are a statistical summary based on a limited number of samples and are provided for informational purposes only. The performance characteristics listed herein are not tested or guaranteed. In some graphs or tables, the data presented may be outside the specified operating range (e.g., outside specified power supply range) and therefore outside the warranted range.

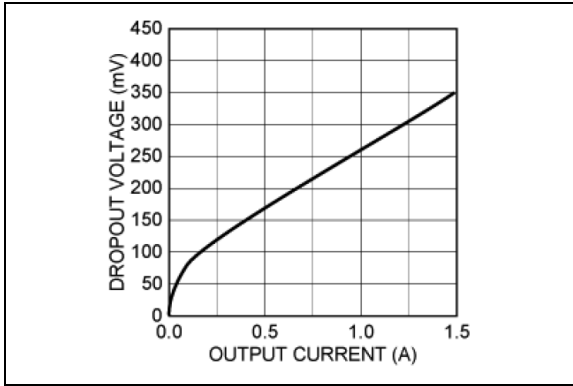

FIGURE 2-1: MIC2915x Dropout Voltage vs. Output Current.

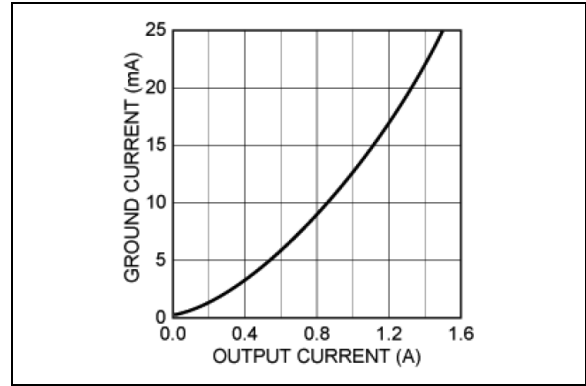

FIGURE 2-4: MIC2915x Ground Current vs. Output Current.

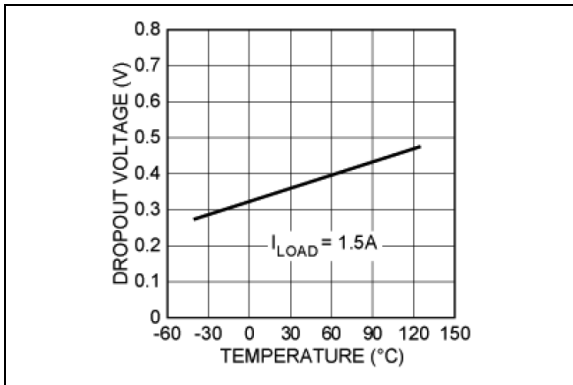

FIGURE 2-2: MIC2915x Dropout Voltage vs. Temperature.

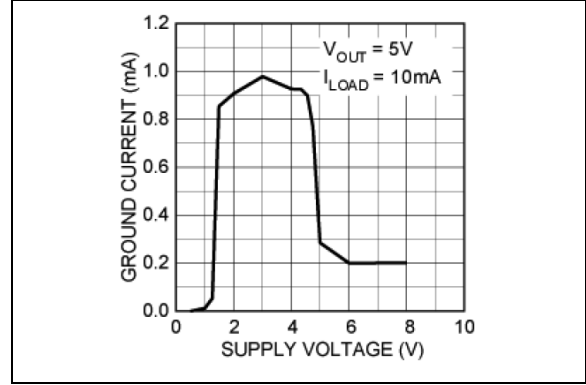

FIGURE 2-5: MIC2915x Ground Current vs. Supply Voltage.

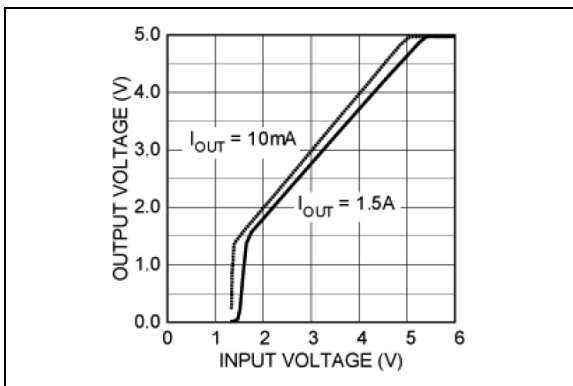

FIGURE 2-3: MIC29150-5.0 Dropout Characteristics.

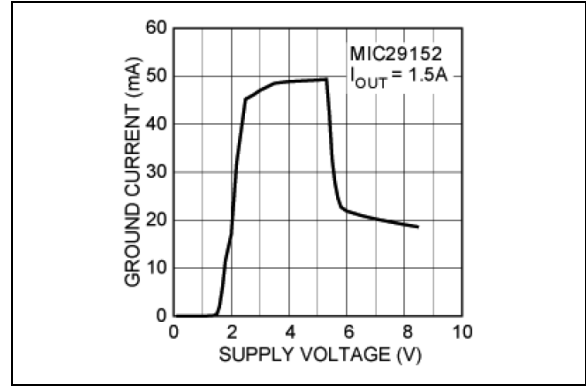

FIGURE 2-6: MIC2915x Ground Current vs. Supply Voltage.

MIC2915X/30X/50X/75X



FIGURE 2-7: MIC2915x Ground Current vs. Temperature.

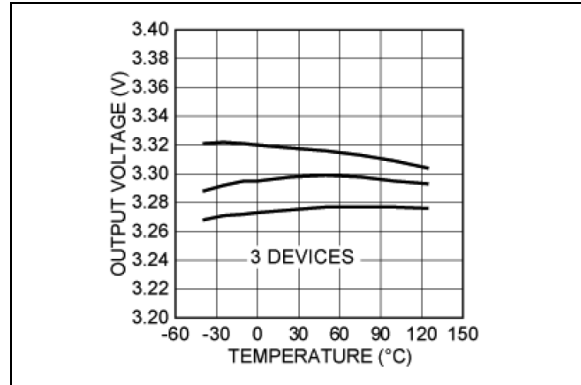

FIGURE 2-10: MIC29150-3.3 Output Voltage vs. Temperature.



FIGURE 2-8: MIC2915x Ground Current vs. Temperature.

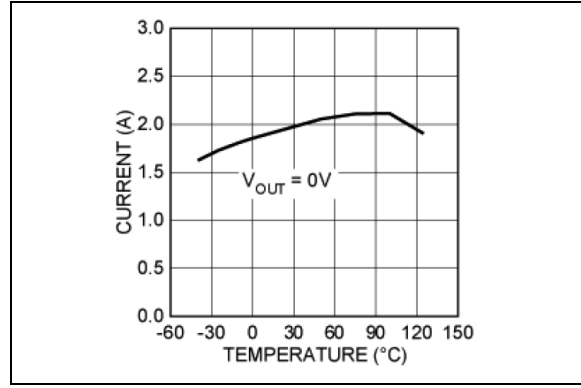

FIGURE 2-11: MIC29150-3.3 Short-Circuit Current vs. Temperature.



FIGURE 2-9: MIC2915x Ground Current vs. Temperature.

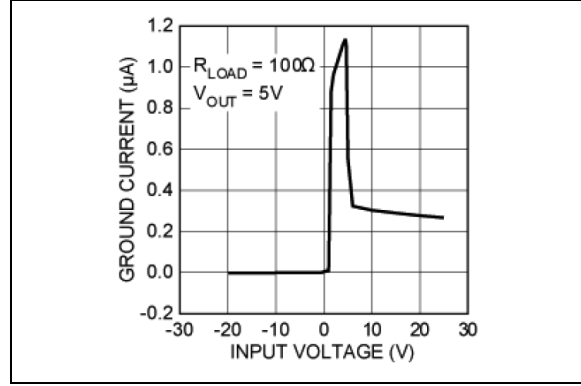

FIGURE 2-12: MIC2915x Ground Current vs. Input Voltage.



FIGURE 2-13: MIC29151-xx/2 Enable Current vs. Temperature.



FIGURE 2-16: MIC29152/3 Adjust Pin Current vs. Temperature.



FIGURE 2-14: MIC2915x Load Transient.



FIGURE 2-17: MIC2915x Line Transient.



FIGURE 2-15: MIC2915x Load Transient.



FIGURE 2-18: MIC2915x Line Transient.

MIC2915X/30X/50X/75X



FIGURE 2-19: MIC2915x Output Impedance vs. Frequency.



FIGURE 2-22: MIC2930x Dropout Voltage vs. Output Current.

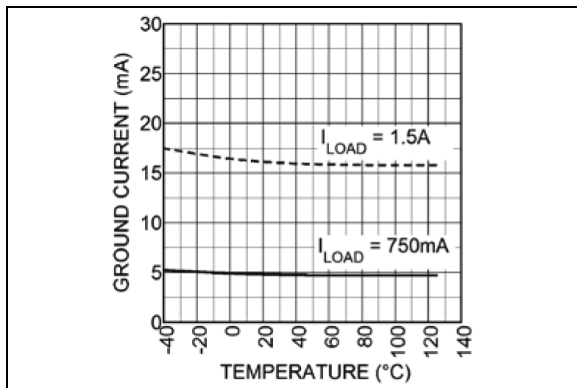

FIGURE 2-20: MIC29152 Ground Current vs. Temperature.

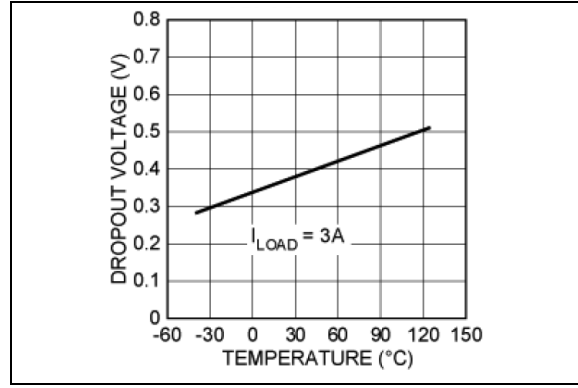

FIGURE 2-23: MIC2930x Dropout Voltage vs. Temperature.



FIGURE 2-21: MIC29152 Dropout Voltage vs. Output Current.



FIGURE 2-24: MIC29300-3.3 Dropout Characteristics.



FIGURE 2-25: MIC2930x Ground Current vs. Output Current.



FIGURE 2-28: MIC2930x Ground Current vs. Temperature.



FIGURE 2-26: MIC2930x Ground Current vs. Supply Voltage.



FIGURE 2-29: MIC2930x Ground Current vs. Temperature.



FIGURE 2-27: MIC2930x Ground Current vs. Supply Voltage.



FIGURE 2-30: MIC2930x Ground Current vs. Temperature.

MIC2915X/30X/50X/75X



FIGURE 2-31: MIC29300-3.3 Output Voltage vs. Temperature.



FIGURE 2-34: MIC29301-xx/2 Enable Current vs. Temperature.



FIGURE 2-32: MIC29300-5.0 Short-Circuit Current vs. Temperature.

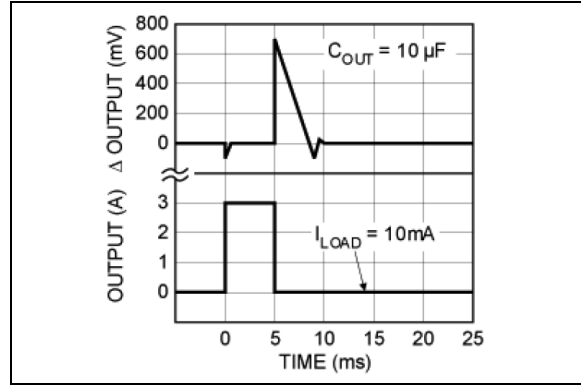

FIGURE 2-35: MIC2930x Load Transient.



FIGURE 2-33: MIC2930x Ground Current vs. Input Voltage.

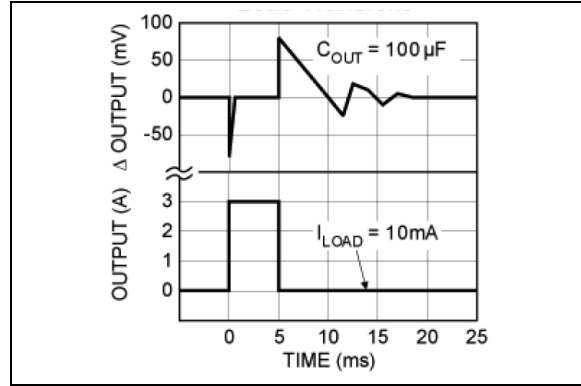

FIGURE 2-36: MIC2930x Load Transient.



FIGURE 2-37: MIC29302/3 Adjust Pin Current vs. Temperature.



FIGURE 2-40: MIC2930x Output Impedance vs. Frequency.



FIGURE 2-38: MIC2930x Line Transient.



FIGURE 2-41: MIC2930x I_{OUT} vs. $V_{IN} - V_{OUT}$ SOA (TO-263).



FIGURE 2-39: MIC2930x Line Transient.



FIGURE 2-42: MIC2930x I_{OUT} vs. T_A SOA (TO-263).

MIC2915X/30X/50X/75X



FIGURE 2-43: MIC2930x Short-Circuit SOA vs. Temperature (TO-263).



FIGURE 2-46: MIC29500-3.3 Dropout Characteristics.



FIGURE 2-44: MIC2950x Dropout Voltage vs. Output Current.



FIGURE 2-47: MIC2950x Ground Current vs. Output Current.



FIGURE 2-45: MIC2950x Dropout Voltage vs. Temperature.



FIGURE 2-48: MIC2950x Ground Current vs. Supply Voltage.



FIGURE 2-49: MIC2950x Ground Current vs. Supply Voltage.



FIGURE 2-52: MIC2950x Ground Current vs. Temperature.



FIGURE 2-50: MIC2950x Ground Current vs. Temperature.

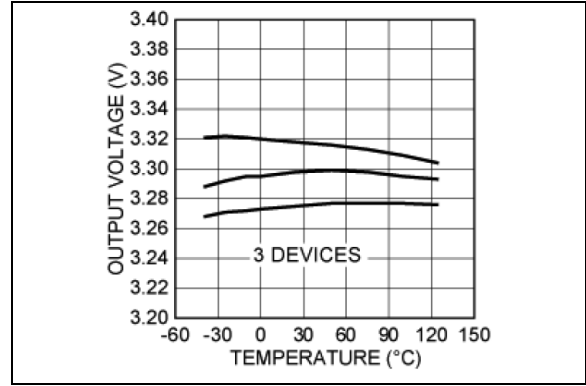

FIGURE 2-53: MIC29500-3.3 Output Voltage vs. Temperature.



FIGURE 2-51: MIC2950x Ground Current vs. Temperature.

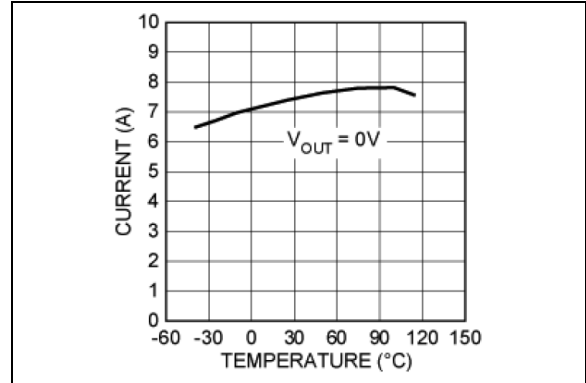

FIGURE 2-54: MIC2950x-5.0 Short-Circuit Current vs. Temperature.

MIC2915X/30X/50X/75X



FIGURE 2-55: MIC2950x Ground Current vs. Input Voltage.



FIGURE 2-58: MIC2950x Load Transient.



FIGURE 2-56: MIC29501-xx/2 Enable Current vs. Temperature.



FIGURE 2-59: MIC29502/3 Adjust Pin Current vs. Temperature.



FIGURE 2-57: MIC2950x Load Transient.



FIGURE 2-60: MIC2950x Line Transient.



FIGURE 2-61: MIC2950x Line Transient.



FIGURE 2-64: MIC2975x Dropout Voltage vs. Temperature.



FIGURE 2-62: MIC2950x Output Impedance vs. Frequency.



FIGURE 2-65: MIC29751-3.3 Dropout Characteristics.



FIGURE 2-63: MIC2975x Dropout Voltage vs. Output Current.



FIGURE 2-66: MIC2975x Ground Current vs. Output Current.

MIC2915X/30X/50X/75X



FIGURE 2-67: MIC2975x Ground Current vs. Supply Voltage.



FIGURE 2-70: MIC2975x Ground Current vs. Temperature.



FIGURE 2-68: MIC2975x Ground Current vs. Supply Voltage.



FIGURE 2-71: MIC2975x Ground Current vs. Temperature.



FIGURE 2-69: MIC2975x Ground Current vs. Temperature.



FIGURE 2-72: MIC29751-3.3 Output Voltage vs. Temperature.



FIGURE 2-73: MIC29751-5.0 Short-Circuit Current vs. Temperature.



FIGURE 2-76: MIC2975x Load Transient.



FIGURE 2-74: MIC2975x Ground Current vs. Input Voltage.



FIGURE 2-77: MIC2975x Load Transient.



FIGURE 2-75: MIC29751-xx/2 Enable Current vs. Temperature.



FIGURE 2-78: MIC29752 Adjust Pin Current vs. Temperature.

MIC2915X/30X/50X/75X



FIGURE 2-79: MIC2975x Line Transient.



FIGURE 2-80: MIC2975x Line Transient.



FIGURE 2-81: MIC2975x Output Impedance vs. Frequency.

3.0 PIN DESCRIPTIONS

The descriptions of the pins are listed in [Table 3-1](#) and [Table 3-2](#).

TABLE 3-1: PIN FUNCTION TABLE

Pin Number TO-220 TO-263	Pin Name	Description
1	INPUT	Supplies the current to the output power device.
2	GND	TAB is also connected internally to the IC's ground on D-PAK.
3	OUTPUT	The regulator output voltage.

TABLE 3-2: PIN FUNCTION TABLE

Pin Number Fixed TO-220 TO-247 TO-263	Pin Number Adjustable TO-220 TO-247 TO-252 TO-263	Pin Number Adj. w/ Flag TO-220 TO-247 TO-263	Pin Name	Description
1	1	—	ENABLE	CMOS compatible control input. Logic-high = enable, logic-low = shutdown.
2	2	2	INPUT	Supplies the current to the output power device.
3, TAB	3, TAB	3, TAB	GND	TAB is also connected internally to the IC's ground on D-PAK.
4	4	4	OUTPUT	The regulator output voltage.
—	5	5	ADJUST	Adjustable regulator feedback input that connects to the resistor voltage divider that is placed from OUTPUT to GND in order to set the output voltage.
5	—	1	FLAG	Active-low error flag output signal that indicates an output fault condition.

MIC2915X/30X/50X/75X

4.0 APPLICATION INFORMATION

The MIC2915x, MIC2930x, MIC2950x, and MIC2975x are high-performance low-dropout voltage regulators suitable for all moderate to high-current voltage regulator applications. Their 350 mV to 425 mV typical dropout voltage at full load make them especially valuable in battery powered systems and as high efficiency noise filters in post-regulator applications. Unlike older NPN-pass transistor designs, where the minimum dropout voltage is limited by the base-emitter voltage drop and collector-emitter saturation voltage, dropout performance of the PNP output of these devices is limited merely by the low VCE saturation voltage.

A trade-off for the low-dropout voltage is a varying base driver requirement. But Microchip's Super β PNP process reduces this drive requirement to merely 1% of the load current.

The MIC2915x/2930x/2950x/2975x family of regulators are fully protected from damage due to fault conditions. Current limiting is provided. This limiting is linear; output current under overload conditions is constant. Thermal shutdown disables the device when the die temperature exceeds the +125°C maximum safe operating temperature. Line transient protection allows device and load survival even when the input voltage spikes between -20V and +60V. When the input voltage exceeds approximately 32V, the overvoltage sensor disables the regulator. The output structure of these regulators allows voltages in excess of the desired output voltage to be applied without reverse current flow. MIC29xx1 and MIC29xx2 versions offer a logic-level ON/OFF control. When disabled, the devices draw nearly zero current.

An additional feature of this regulator family is a common pinout. A design's current requirement may change up or down, but use the same board layout because all of these regulators have identical pinouts.



FIGURE 4-1: Linear Regulators Require Only Two Capacitors for Operation.

4.1 Thermal Design

Linear regulators are simple to use. The most complicated design parameters to consider are thermal characteristics. Thermal design requires the following application-specific parameters:

- Maximum Ambient Temperature, T_A
- Output Current, I_{OUT}
- Output Voltage, V_{OUT}
- Input Voltage, V_{IN}

First, calculate the power dissipation of the regulator from these numbers and the device parameters from this data sheet.

EQUATION 4-1:

$$P_D = I_{OUT}(1.01(V_{IN} - V_{OUT}))$$

The ground current is approximated by 1% of I_{OUT} . Then the heat sink thermal resistance is determined with [Equation 4-2](#).

EQUATION 4-2:

$$\theta_{SA} = \frac{T_{JMAX} - T_A}{P_D} - (\theta_{JC} + \theta_{CS})$$

Where:

$$T_{JMAX} \leq 125^\circ\text{C}$$

$$\theta_{CS} \text{ Between } 0^\circ\text{C/W and } 2^\circ\text{C/W}$$

The heat sink may be significantly reduced in applications where the minimum input voltage is known and is large compared with the dropout voltage. Use a series input resistor to drop excessive voltage and distribute the heat between this resistor and the regulator. The low-dropout properties of Super β PNP regulators allow very significant reductions in regulator power dissipation and the associated heat sink without compromising performance. When this technique is employed, a capacitor of at least 0.1 μF is needed directly between the input and regulator ground.

Please refer to [Application Note 9](#) and [Application Hint 17](#) for further details and examples on thermal design and heat sink specification.

With no heat sink in the application, calculate the junction temperature to determine the maximum power dissipation that will be allowed before exceeding the maximum junction temperature of the MIC29152. The maximum power allowed can be calculated using the

thermal resistance (θ_{JA}) of the D-Pak adhering to the following criteria for the PCB design: 2 oz. copper and 100 mm² copper area for the MIC29152.

For example, given an expected maximum ambient temperature (T_A) of +75°C with $V_{IN} = 3.3V$, $V_{OUT} = 2.5V$, and $I_{OUT} = 1.5A$, first calculate the expected P_D using Equation 4-3:

EQUATION 4-3:

$$P_D = (3.3V - 2.5V) \times 1.5A - (3.3V \times 0.016A) = 1.1472W$$

Next, calculate the junction temperature for the expected power dissipation.

EQUATION 4-4:

$$T_J = (\theta_{JA} \times P_D) + T_A = (56^\circ C/W \times 1.1472W) + 75^\circ C = 139.24^\circ C$$

Now determine the maximum power dissipation allowed that would not exceed the IC's maximum junction temperature (+125°C) without the use of a heat sink.

EQUATION 4-5:

$$P_{D(MAX)} = (T_{J(MAX)} - T_A) \div \theta_{JA} = (125^\circ C - 75^\circ C) \div 56^\circ C/W = 0.893W$$

4.2 Capacitor Requirements

For stability and minimum output noise, a capacitor on the regulator output is necessary. The value of this capacitor is dependent upon the output current; lower currents allow smaller capacitors. The MIC2915x/2930x/2950x/2975x regulators are stable with the following minimum capacitor values at full load, as noted in Table 4-1.

TABLE 4-1: MINIMUM CAPACITOR VALUES AT FULL LOAD

Device	Full-Load Capacitor
MIC2915x	10 μ F
MIC2930x	10 μ F
MIC2950x	10 μ F
MIC2975x	22 μ F

This capacitor need not be an expensive low ESR type: aluminum electrolytics are adequate. In fact, extremely low ESR capacitors may contribute to instability. Tantalum capacitors are recommended for systems where fast load transient response is important.

Where the regulator is powered from a source with high AC impedance, a 0.1 μ F capacitor connected between Input and GND is recommended. This capacitor should have good characteristics to above 250 kHz.

4.3 Minimum Load Current

The MIC2915x–2975x regulators are specified between finite loads. If the output current is too small, leakage currents dominate and the output voltage rises. The following minimum load current swamps any expected leakage current across the operating temperature range, as shown in Table 4-2.

TABLE 4-2: MINIMUM LOAD CURRENTS

Device	Minimum Load
MIC2915x	5 mA
MIC2930x	7 mA
MIC2950x	10 mA
MIC2975x	10 mA

4.4 Adjustable Regulator Design

The adjustable regulator versions, MIC29xx2 and MIC29xx3, allow programming the output voltage anywhere between 1.25V and the 25V. Two resistors are used. The resistor values are calculated by Equation 4-6.

EQUATION 4-6:

$$R1 = R2 \times \left(\frac{V_{OUT}}{1.240} - 1 \right)$$

In the equation above, V_{OUT} is the desired output voltage. Figure 4-2 shows component definition. Applications with widely varying load currents may scale the resistors to draw the minimum load current required for proper operation (see the Minimum Load Current sub-section).

MIC2915X/30X/50X/75X



FIGURE 4-2: Adjustable Regulator with Resistors.

4.5 Error Flag

MIC29xx1 and MIC29xx3 versions feature an Error Flag, which looks at the output voltage and signals an error condition when this voltage drops 5% below its expected value. The error flag is an open-collector output that pulls low under fault conditions. It may sink 10 mA. Low output voltage signifies a number of possible problems, including an overcurrent fault (the device is in current-limit) and low input voltage. The flag output is inoperative during overtemperature shutdown conditions.

4.6 Enable Input

MIC29xx1 and MIC29xx2 versions feature an enable (EN) input that allows ON/OFF control of the device. Special design allows “zero” current drain when the device is disabled; only microamperes of leakage current flows. The EN input has TTL/CMOS compatible thresholds for simple interfacing with logic, or may be directly tied to $\leq 30V$. Enabling the regulator requires approximately 20 μA of current.

5.0 PACKAGING INFORMATION

5.1 Package Marking Information

3- and 5-Pin TO-263 (Fixed)*

XXXXXXXXX
X.XXX
WNNNP

Example

MIC29150
3.3WU
8943P

5-Pin TO-263 (Adjustable)*

XXX
XXXXXXXXX
WNNNP

Example

MIC
29152WU
6235P

3- and 5-Pin TO-220 (Fixed)*

XXXXX
X.XXX
WNNNP

Example

29301
5.0WT
1586P

5-Pin TO-220 (Adjustable)*

XXX
XXXXXXXXX
WNNNP

Example

MIC
29302WT
7404P

MIC2915X/30X/50X/75X

5-Pin TO-252*

```

mXXX
XXXXXXXX
WNNNP<BS1><COO>
    
```

Example

```

mMIC
29152WD
3102P USA
    
```

5-Pin TO-247 (Fixed)*

```

mXXXXX
XXXXXXXXX-X.XXXX
WNNNP
<COO>
YYWWNNN
    
```

Example

```

mMICREL
MIC29751-3.3WWT
5943P
USA
1642815
    
```

5-Pin TO-247 (Adjustable)*

```

mXXXXX
XXXXXXXXXXXXX
WNNNP
<COO>
YYWWNNN
    
```

Example

```

mMICREL
MIC29752WWT
2359P
USA
1521108
    
```

Legend:	XX...X	Product code or customer-specific information
	Y	Year code (last digit of calendar year)
	YY	Year code (last 2 digits of calendar year)
	WW	Week code (week of January 1 is week '01')
	NNN	Alphanumeric traceability code
	(e3)	Pb-free JEDEC® designator for Matte Tin (Sn)
	*	This package is Pb-free. The Pb-free JEDEC designator ((e3)) can be found on the outer packaging for this package.
	•, ▲, ▼	Pin one index is identified by a dot, delta up, or delta down (triangle mark).
Note:	In the event the full Microchip part number cannot be marked on one line, it will be carried over to the next line, thus limiting the number of available characters for customer-specific information. Package may or may not include the corporate logo.	
	Underbar (_) and/or Overbar (¯) symbol may not be to scale.	

MIC2915X/30X/50X/75X

3-Lead TO-220 Package Outline and Recommended Land Pattern

TITLE

3 LEAD TO220 PACKAGE OUTLINE & RECOMMENDED LAND PATTERN

DRAWING #	TO220-3LD-PL-1	UNIT	INCH
Lead Frame	Copper Alloy	Lead Finish	Matte Tin

Top View

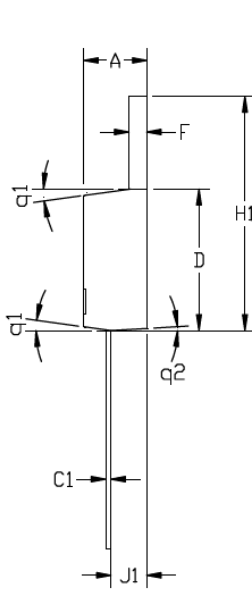
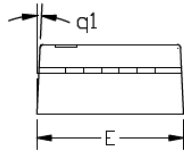
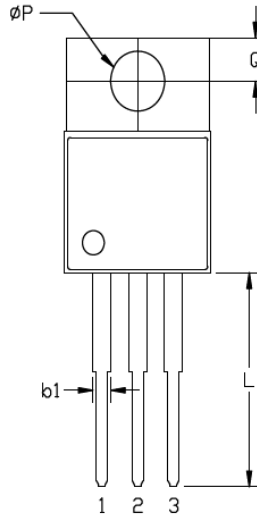

Btm View

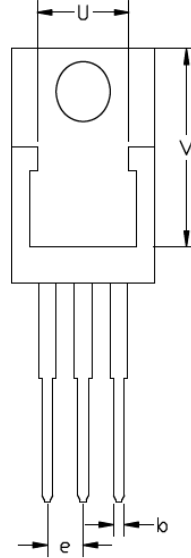

POS	INCH	
	MIN	MAX
A	0.160	0.190
b	0.025	0.040
b1	0.045	0.060
C1	0.012	0.022
D	0.348	0.360
E	0.385	0.420
e	0.090	0.110
F	0.045	0.055
H1	0.541	0.619
J1	0.080	0.120
ØP	0.146	0.156
Q	0.103	0.113
L	0.500	0.580
q1	3°	10°
q2	1°	7°
U	0.256	Ref.
V	0.486	Ref.

Note : Foot Length using gauge plane method measurement 0.010".

Note: For the most current package drawings, please see the Microchip Packaging Specification located at <http://www.microchip.com/packaging>.

MIC2915X/30X/50X/75X

5-Lead TO-220 Package Outline and Recommended Land Pattern

TITLE

5 LEAD TO220 PACKAGE OUTLINE & RECOMMENDED LAND PATTERN

DRAWING #	TO220-5LD-PL-1	UNIT	INCH
Lead Frame	Copper Alloy	Lead Finish	Matte Tin

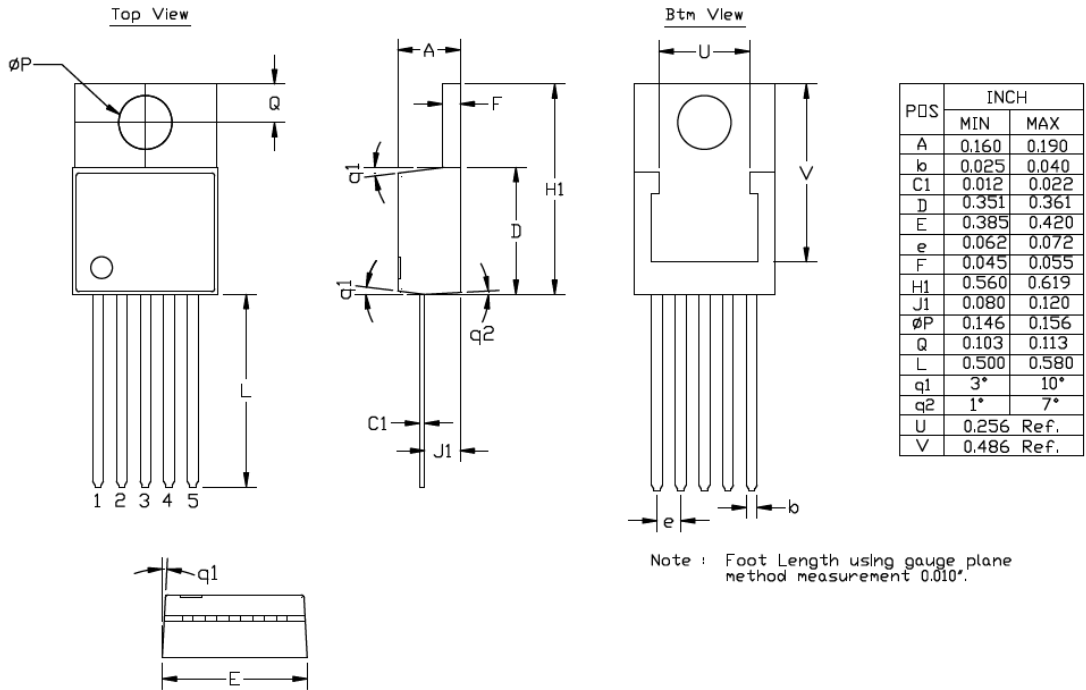

Note: For the most current package drawings, please see the Microchip Packaging Specification located at <http://www.microchip.com/packaging>.

MIC2915X/30X/50X/75X

5-Lead TO-263 (DDPAK) Package Outline and Recommended Land Pattern

5-Lead Plastic (ET) [DDPAK]

Note: For the most current package drawings, please see the Microchip Packaging Specification located at <http://www.microchip.com/packaging>



Dimension Limits	Units	INCHES		
		MIN	NOM	MAX
Number of Pins	N	5		
Pitch	e	.067 BSC		
Overall Height	A	.160	–	.190
Standoff §	A1	.000	–	.010
Overall Width	E	.380	–	.420
Exposed Pad Width	E1	.245	–	–
Molded Package Length	D	.330	–	.380
Overall Length	H	.549	–	.625
Exposed Pad Length	D1	.270	–	–
Lead Thickness	c	.014	–	.029
Pad Thickness	C2	.045	–	.065
Lead Width	b	.020	–	.039
Foot Length	L	.068	–	.110
Pad Length	L1	–	–	.067
Foot Angle	ϕ	0°	–	8°

Notes:

- § Significant Characteristic.
- Dimensions D and E do not include mold flash or protrusions. Mold flash or protrusions shall not exceed .005" per side.
- Dimensioning and tolerancing per ASME Y14.5M.

BSC: Basic Dimension. Theoretically exact value shown without tolerances.

Microchip Technology Drawing C04-012B

MIC2915X/30X/50X/75X

5-Lead Plastic (ET) [DDPAK]

Note: For the most current package drawings, please see the Microchip Packaging Specification located at <http://www.microchip.com/packaging>



RECOMMENDED LAND PATTERN

Dimension Limits	Units	INCHES		
		MIN	NOM	MAX
Contact Pitch	E		.067 BSC	
Optional Center Pad Width	X2			.423
Optional Center Pad Length	Y2			.327
Contact Pad Spacing	C1		.248	
Contact Pad Width (X5)	X1			.041
Contact Pad Length (X5)	Y1			.159

Notes:

1. Dimensioning and tolerancing per ASME Y14.5M

BSC: Basic Dimension. Theoretically exact value shown without tolerances.

Microchip Technology Drawing No. C04-2012A

MIC2915X/30X/50X/75X

3-Lead TO-263 Package Outline and Recommended Land Pattern

TITLE

3 LEAD TO263 PACKAGE OUTLINE & RECOMMENDED LAND PATTERN

DRAWING # TO263-3LD-PL-1

UNIT INCH/MM



TOP VIEW

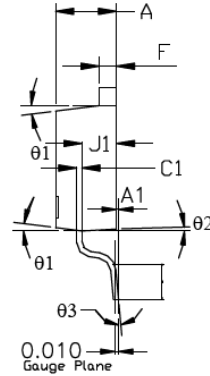

SIDE VIEW 1

POS	INCH		MM	
	MIN	MAX	MIN	MAX
A	0.170	0.181	4.318	4.597
A1	0.000	0.012	0.000	0.305
b1	0.047	0.053	1.194	1.346
C1	0.012	0.023	0.305	0.584
D	0.330	0.361	8.382	9.169
E	0.396	0.420	10.058	10.668
e	0.095	0.105	2.413	2.667
F	0.045	0.055	1.143	1.397
H	0.575	0.625	14.605	15.875
J1	0.080	0.120	2.032	3.048
L1	0.090	0.110	2.286	2.794
K	0.045	0.066	1.143	1.676
theta1	3°	10°	3°	10°
theta2	1°	7°	1°	7°
theta3	0°	8°	0°	8°
theta4	18°	22°	18°	22°
Q	0.055	0.075	1.397	1.905
U	0.256	Ref.	6.502	Ref.
V	0.303	Ref.	7.696	Ref.



BOTTOM VIEW

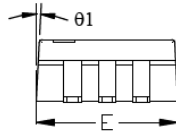

SIDE VIEW 2



RECOMMENDED LAND PATTERN (UNIT: INCH)

NOTES:

FOOT LENGTH USE GAUGE PLANE METHOD MEASUREMENT 0.010"

Note: For the most current package drawings, please see the Microchip Packaging Specification located at <http://www.microchip.com/packaging>.

MIC2915X/30X/50X/75X

5-Lead TO-247 Package Outline and Recommended Land Pattern

TITLE

5 LEAD TO247 PACKAGE OUTLINE & RECOMMENDED LAND PATTERN

DRAWING #	TO247-5LD-PL-1	UNIT	INCH/ MM
Lead Frame	Copper Alloy	Lead Finish	Matte Tin



NOTE

1. CONTROLLED DIMENSION IS INCH. DIMENSION IN BLANKET IS MILLIMETER.
2. DIMENSIONS DO NOT INCLUDE END FLASH, MOLD FLASH, MATERIAL PROTRUSIONS.

Note: For the most current package drawings, please see the Microchip Packaging Specification located at <http://www.microchip.com/packaging>.

MIC2915X/30X/50X/75X

5-Lead TO-252 Package Outline and Recommended Land Pattern

TITLE

5 LEAD TO252 PACKAGE OUTLINE & RECOMMENDED LAND PATTERN

DRAWING #	TO252-5LD-PL-1	UNIT	INCH/ MM
Lead Frame	Copper Alloy	Lead Finish	Matte Tin

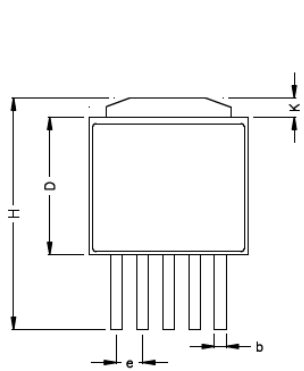

TOP VIEW

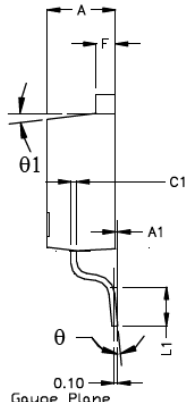

SIDE VIEW 1

POS	INCH		MM	
	MIN	MAX	MIN	MAX
A	0.087	0.094	2.210	2.387
A1	0.000	0.012	0.000	0.305
b	0.023	0.026	0.584	0.660
C1	0.012	0.023	0.305	0.584
D	0.236	0.241	6.000	6.200
E	0.252	0.260	6.400	6.604
e	0.045	0.055	1.143	1.397
F	0.019	0.023	0.483	0.584
H	0.378	0.402	9.601	10.210
K	0.039	0.047	1.000	1.200
L1	0.055	0.065	1.397	1.651
theta	0°	8°	0°	8°
theta1	3°	10°	3°	10°
Q	0.055	0.075	1.397	1.905
U	0.206	Ref.	5.232	Ref.
V	0.213	Ref.	5.415	Ref.

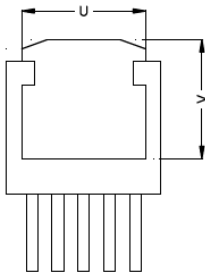

BOTTOM VIEW

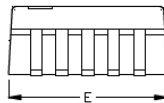

SIDE VIEW 2

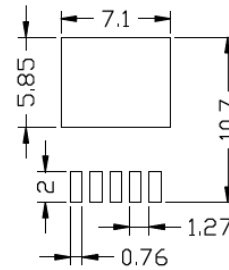

RECOMMENDED LAND PATTERN

NOTE: unit in mm

- NOTE:
1. PACKAGE OUTLINE EXCLUSIVE OF MOLD FLASH & METAL BURR.
 2. PACKAGE OUTLINE INCLUSIVE OF PLATING THICKNESS.
 3. FOOT LENGTH USING GAUGE PLANE METHOD MEASUREMENT 0.010"
 4. ALL DIMENSIONS ARE IN INCHES/MILLIMETERS.

Note: For the most current package drawings, please see the Microchip Packaging Specification located at <http://www.microchip.com/packaging>.

MIC2915X/30X/50X/75X

NOTES:

APPENDIX A: REVISION HISTORY

Revision A (December 2016)

- Converted Micrel document MIC2915x/30x/50x/75x to Microchip data sheet DS20005685A.
- Minor text changes throughout.
- Removed references to the discontinued MIC29750.
- Added [Figure 2-41](#), [Figure 2-42](#), and [Figure 2-43](#).
- Removed the 3-Pin TO-247 package option.

Revision B (January 2019)

- Updated package drawing for [5-Lead TO-263 \(DDPAK\) Package Outline and Recommended Land Pattern](#) option.

MIC2915X/30X/50X/75X

NOTES:

MIC2915X/30X/50X/75X

PRODUCT IDENTIFICATION SYSTEM

To order or obtain information, e.g., on pricing or delivery, contact your local Microchip representative or sales office.

<u>PART NO.</u>	-	<u>XX</u>	<u>X</u>	<u>X</u>	-	<u>XX</u>
Device	Voltage	Junction Temperature Range	Package	Media Type		
Device:	MIC2915x:	1.5A High-Current Low-Dropout Regulator				
	MIC2930x:	3A High-Current Low-Dropout Regulator				
	MIC2950x:	5A High-Current Low-Dropout Regulator				
	MIC2975x:	7.5A High-Current Low-Dropout Regulator				
Voltage:	3.3	= 3.3V				
	5.0	= 5.0V				
	12	= 12V				
	(blank)	= Adjustable				
Junction Temperature Range:	W	= -40°C to +125°C				
Package:	U	= 3-Lead or 5-Lead TO-263				
	T	= 3-Lead or 5-Lead TO-220				
	D	= 5-Lead TO-252				
	WT	= 5-Lead TO-247				
Media Type:	TR	= 2,500/Reel for D and WT Packages				
	TR	= 750/Reel for U Package				
	(blank)	= 50/Tube for U, T, and D Packages				
	(blank)	= 30/Tube for WT Package				
Examples:						
a) MIC29150-3.3WT: 1.5A High-Current Low-Dropout Regulator, 3.3V, -40°C to +125°C Temperature Range, 3-Lead TO-220, 50/Tube						
b) MIC29152WD-TR: 1.5A High-Current Low-Dropout Regulator, Adjustable Voltage, -40°C to +125°C Temperature Range, 5-Lead TO-252, 2,500/Reel						
c) MIC29302WU: 3A High-Current Low-Dropout Regulator, Adjustable Voltage, -40°C to +125°C Temperature Range, 5-Lead TO-263, 50/Tube						
d) MIC29301-12WU-TR: 3A High-Current Low-Dropout Regulator, 12V, -40°C to +125°C Temperature Range, 5-Lead TO-263, 750/Reel						
e) MIC29500-5.0WT: 5A High-Current Low-Dropout Regulator, 5.0V, -40°C to +125°C Temperature Range, 3-Lead TO-220, 50/Tube						
f) MIC29503WT: 5A High-Current Low-Dropout Regulator, Adjustable Voltage, -40°C to +125°C Temperature Range, 5-Lead TO-220, 50/Tube						
g) MIC29751-3.3WWT-TR: 7.5A High-Current Low-Dropout Regulator, 3.3V, -40°C to +125°C Temperature Range, 5-Lead TO-247, 2,500/Reel						
h) MIC29752WWT: 7.5A High-Current Low-Dropout Regulator, Adjustable Voltage, -40°C to +125°C Temperature Range, 5-Lead TO-247, 30/Tube						
Note 1: Tape and Reel identifier only appears in the catalog part number description. This identifier is used for ordering purposes and is not printed on the device package. Check with your Microchip Sales Office for package availability with the Tape and Reel option.						

MIC2915X/30X/50X/75X

NOTES:

Note the following details of the code protection feature on Microchip devices:

- Microchip products meet the specification contained in their particular Microchip Data Sheet.
- Microchip believes that its family of products is one of the most secure families of its kind on the market today, when used in the intended manner and under normal conditions.
- There are dishonest and possibly illegal methods used to breach the code protection feature. All of these methods, to our knowledge, require using the Microchip products in a manner outside the operating specifications contained in Microchip's Data Sheets. Most likely, the person doing so is engaged in theft of intellectual property.
- Microchip is willing to work with the customer who is concerned about the integrity of their code.
- Neither Microchip nor any other semiconductor manufacturer can guarantee the security of their code. Code protection does not mean that we are guaranteeing the product as “unbreakable.”

Code protection is constantly evolving. We at Microchip are committed to continuously improving the code protection features of our products. Attempts to break Microchip's code protection feature may be a violation of the Digital Millennium Copyright Act. If such acts allow unauthorized access to your software or other copyrighted work, you may have a right to sue for relief under that Act.

Information contained in this publication regarding device applications and the like is provided only for your convenience and may be superseded by updates. It is your responsibility to ensure that your application meets with your specifications. MICROCHIP MAKES NO REPRESENTATIONS OR WARRANTIES OF ANY KIND WHETHER EXPRESS OR IMPLIED, WRITTEN OR ORAL, STATUTORY OR OTHERWISE, RELATED TO THE INFORMATION, INCLUDING BUT NOT LIMITED TO ITS CONDITION, QUALITY, PERFORMANCE, MERCHANTABILITY OR FITNESS FOR PURPOSE. Microchip disclaims all liability arising from this information and its use. Use of Microchip devices in life support and/or safety applications is entirely at the buyer's risk, and the buyer agrees to defend, indemnify and hold harmless Microchip from any and all damages, claims, suits, or expenses resulting from such use. No licenses are conveyed, implicitly or otherwise, under any Microchip intellectual property rights unless otherwise stated.

Microchip received ISO/TS-16949:2009 certification for its worldwide headquarters, design and wafer fabrication facilities in Chandler and Tempe, Arizona; Gresham, Oregon and design centers in California and India. The Company's quality system processes and procedures are for its PIC® MCUs and dsPIC® DSCs, KEELOQ® code hopping devices, Serial EEPROMs, microperipherals, nonvolatile memory and analog products. In addition, Microchip's quality system for the design and manufacture of development systems is ISO 9001:2000 certified.

**QUALITY MANAGEMENT SYSTEM
CERTIFIED BY DNV
= ISO/TS 16949 =**

Trademarks

The Microchip name and logo, the Microchip logo, AnyRate, AVR, AVR logo, AVR Freaks, BitCloud, chipKIT, chipKIT logo, CryptoMemory, CryptoRF, dsPIC, FlashFlex, flexPWR, Helder, JukeBlox, KeeLoq, Klear, LANCheck, LINK MD, maXStylus, maXTouch, MediaLB, megaAVR, MOST, MOST logo, MPLAB, OptoLyzer, PIC, picoPower, PICSTART, PIC32 logo, Prochip Designer, QTouch, SAM-BA, SpyNIC, SST, SST Logo, SuperFlash, tinyAVR, UNI/O, and XMEGA are registered trademarks of Microchip Technology Incorporated in the U.S.A. and other countries.

ClockWorks, The Embedded Control Solutions Company, EtherSynch, Hyper Speed Control, HyperLight Load, IntellIMOS, mTouch, Precision Edge, and Quiet-Wire are registered trademarks of Microchip Technology Incorporated in the U.S.A.

Adjacent Key Suppression, AKS, Analog-for-the-Digital Age, Any Capacitor, AnyIn, AnyOut, BodyCom, CodeGuard, CryptoAuthentication, CryptoAutomotive, CryptoCompanion, CryptoController, dsPICDEM, dsPICDEM.net, Dynamic Average Matching, DAM, ECAN, EtherGREEN, In-Circuit Serial Programming, ICSP, INICnet, Inter-Chip Connectivity, JitterBlocker, KlearNet, KlearNet logo, memBrain, Mindi, MiWi, motorBench, MPASM, MPF, MPLAB Certified logo, MPLIB, MPLINK, MultiTRAK, NetDetach, Omniscient Code Generation, PICDEM, PICDEM.net, PICKit, PICtail, PowerSmart, PureSilicon, QMatrix, REAL ICE, Ripple Blocker, SAM-ICE, Serial Quad I/O, SMART-I.S., SQI, SuperSwitcher, SuperSwitcher II, Total Endurance, TSHARC, USBCheck, VariSense, ViewSpan, WiperLock, Wireless DNA, and ZENA are trademarks of Microchip Technology Incorporated in the U.S.A. and other countries.

SQTP is a service mark of Microchip Technology Incorporated in the U.S.A.

Silicon Storage Technology is a registered trademark of Microchip Technology Inc. in other countries.

GestIC is a registered trademark of Microchip Technology Germany II GmbH & Co. KG, a subsidiary of Microchip Technology Inc., in other countries.

All other trademarks mentioned herein are property of their respective companies.

© 2016-2019, Microchip Technology Incorporated, All Rights Reserved.

ISBN: 978-1-5224-4105-2



MICROCHIP

Worldwide Sales and Service

AMERICAS

Corporate Office
2355 West Chandler Blvd.
Chandler, AZ 85224-6199
Tel: 480-792-7200
Fax: 480-792-7277
Technical Support:
<http://www.microchip.com/support>
Web Address:
www.microchip.com

Atlanta

Duluth, GA
Tel: 678-957-9614
Fax: 678-957-1455

Austin, TX

Tel: 512-257-3370

Boston

Westborough, MA
Tel: 774-760-0087
Fax: 774-760-0088

Chicago

Itasca, IL
Tel: 630-285-0071
Fax: 630-285-0075

Dallas

Addison, TX
Tel: 972-818-7423
Fax: 972-818-2924

Detroit

Novi, MI
Tel: 248-848-4000

Houston, TX

Tel: 281-894-5983

Indianapolis

Noblesville, IN
Tel: 317-773-8323
Fax: 317-773-5453
Tel: 317-536-2380

Los Angeles

Mission Viejo, CA
Tel: 949-462-9523
Fax: 949-462-9608
Tel: 951-273-7800

Raleigh, NC

Tel: 919-844-7510

New York, NY

Tel: 631-435-6000

San Jose, CA

Tel: 408-735-9110
Tel: 408-436-4270

Canada - Toronto

Tel: 905-695-1980
Fax: 905-695-2078

ASIA/PACIFIC

Australia - Sydney
Tel: 61-2-9868-6733

China - Beijing
Tel: 86-10-8569-7000

China - Chengdu
Tel: 86-28-8665-5511

China - Chongqing
Tel: 86-23-8980-9588

China - Dongguan
Tel: 86-769-8702-9880

China - Guangzhou
Tel: 86-20-8755-8029

China - Hangzhou
Tel: 86-571-8792-8115

China - Hong Kong SAR
Tel: 852-2943-5100

China - Nanjing
Tel: 86-25-8473-2460

China - Qingdao
Tel: 86-532-8502-7355

China - Shanghai
Tel: 86-21-3326-8000

China - Shenyang
Tel: 86-24-2334-2829

China - Shenzhen
Tel: 86-755-8864-2200

China - Suzhou
Tel: 86-186-6233-1526

China - Wuhan
Tel: 86-27-5980-5300

China - Xian
Tel: 86-29-8833-7252

China - Xiamen
Tel: 86-592-2388138

China - Zhuhai
Tel: 86-756-3210040

ASIA/PACIFIC

India - Bangalore
Tel: 91-80-3090-4444

India - New Delhi
Tel: 91-11-4160-8631

India - Pune
Tel: 91-20-4121-0141

Japan - Osaka
Tel: 81-6-6152-7160

Japan - Tokyo
Tel: 81-3-6880-3770

Korea - Daegu
Tel: 82-53-744-4301

Korea - Seoul
Tel: 82-2-554-7200

Malaysia - Kuala Lumpur
Tel: 60-3-7651-7906

Malaysia - Penang
Tel: 60-4-227-8870

Philippines - Manila
Tel: 63-2-634-9065

Singapore
Tel: 65-6334-8870

Taiwan - Hsin Chu
Tel: 886-3-577-8366

Taiwan - Kaohsiung
Tel: 886-7-213-7830

Taiwan - Taipei
Tel: 886-2-2508-8600

Thailand - Bangkok
Tel: 66-2-694-1351

Vietnam - Ho Chi Minh
Tel: 84-28-5448-2100

EUROPE

Austria - Wels
Tel: 43-7242-2244-39
Fax: 43-7242-2244-393

Denmark - Copenhagen
Tel: 45-4450-2828
Fax: 45-4485-2829

Finland - Espoo
Tel: 358-9-4520-820

France - Paris
Tel: 33-1-69-53-63-20
Fax: 33-1-69-30-90-79

Germany - Garching
Tel: 49-8931-9700

Germany - Haan
Tel: 49-2129-3766400

Germany - Heilbronn
Tel: 49-7131-67-3636

Germany - Karlsruhe
Tel: 49-721-625370

Germany - Munich
Tel: 49-89-627-144-0
Fax: 49-89-627-144-44

Germany - Rosenheim
Tel: 49-8031-354-560

Israel - Ra'anana
Tel: 972-9-744-7705

Italy - Milan
Tel: 39-0331-742611
Fax: 39-0331-466781

Italy - Padova
Tel: 39-049-7625286

Netherlands - Drunen
Tel: 31-416-690399
Fax: 31-416-690340

Norway - Trondheim
Tel: 47-7288-4388

Poland - Warsaw
Tel: 48-22-3325737

Romania - Bucharest
Tel: 40-21-407-87-50

Spain - Madrid
Tel: 34-91-708-08-90
Fax: 34-91-708-08-91

Sweden - Gothenberg
Tel: 46-31-704-60-40

Sweden - Stockholm
Tel: 46-8-5090-4654

UK - Wokingham
Tel: 44-118-921-5800
Fax: 44-118-921-5820

Looking for pricing, stock, or lifecycle information?

Click below to explore more details on WIN SOURCE:

- ⊖ [View MIC29750-5.0WWT on WIN SOURCE](#)
- ⊖ [Microchip Technology](#) Information

Optimize Your Supply Chain with WIN SOURCE Solutions

- ✓ Global Sourcing Solution
- ✓ Obsolete Management
- ✓ Cost Control Management
- ✓ Shortage Management
- ✓ Alternative Solution
- ✓ Excess Inventory Management