

### General Description

The MIC5225 is a 150mA highly accurate, low dropout regulator with high input voltage and ultra-low ground current. This combination of high voltage and low ground current makes the MIC5225 ideal for a wide variety of applications including USB and portable electronics applications, using 1-cell, 2-cell or 3-cell Li-Ion battery inputs.

A  $\mu$ Cap LDO design, the MIC5225 is stable with either a ceramic or tantalum output capacitor. It only requires a 2.2 $\mu$ F capacitor for stability.

Features of the MIC5225 includes enable input, thermal shutdown, current limit, reverse battery protection, and reverse leakage protection.

Available in fixed and adjustable output voltage versions, the MIC5225 is offered in the IttyBitty<sup>®</sup> SOT23-5 package with a junction temperature range of  $-40^{\circ}\text{C}$  to  $+125^{\circ}\text{C}$ .

Data sheets and support documentation can be found on Micrel's web site at [www.micrel.com](http://www.micrel.com).

### Features

- Wide input voltage range: 2.3V to 16V
- High output accuracy of  $\pm 2.0\%$  over temperature
- Guaranteed 150mA output
- Very low ground current: 29 $\mu$ A
- Low dropout voltage of 310mV at 150mA
- $\mu$ Cap: Stable with ceramic or tantalum capacitors
- Excellent line and load regulation specifications
- Reverse battery protection
- Reverse leakage protection
- Zero shutdown current
- Thermal shutdown and current limit protection
- IttyBitty<sup>®</sup> SOT23-5 Package

### Applications

- Cellular phones
- Keep alive supply in notebook and portable computers
- Battery-powered equipment
- Consumer/personal electronics
- High-efficiency linear power supplies
- Automotive electronics

### Typical Application

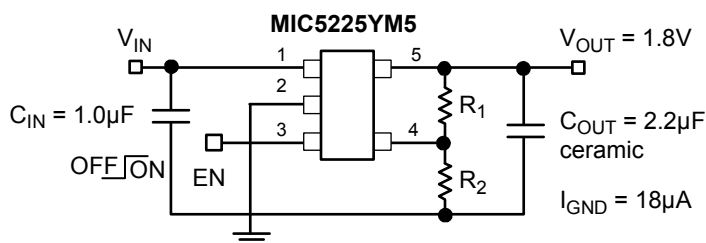

Ultra-Low Current Adjustable Regulator Application

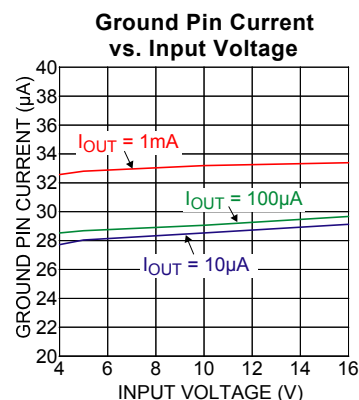

IttyBitty is a registered trademark of Micrel, Inc.

## Ordering Information

| Part Number    | Marking*     | Voltage** | Junction Temp. Range | Package     | Lead Finish |
|----------------|--------------|-----------|----------------------|-------------|-------------|
| MIC5225-1.5YM5 | <u>QT</u> 15 | 1.5V      | -40° to +125°C       | 5-Pin SOT23 | Pb-Free     |
| MIC5225-1.8YM5 | <u>QT</u> 18 | 1.8V      | -40° to +125°C       | 5-Pin SOT23 | Pb-Free     |
| MIC5225-2.5YM5 | <u>QT</u> 25 | 2.5V      | -40° to +125°C       | 5-Pin SOT23 | Pb-Free     |
| MIC5225-2.7YM5 | <u>QT</u> 27 | 2.7V      | -40° to +125°C       | 5-Pin SOT23 | Pb-Free     |
| MIC5225-3.0YM5 | <u>QT</u> 30 | 3.0V      | -40° to +125°C       | 5-Pin SOT23 | Pb-Free     |
| MIC5225-3.3YM5 | <u>QT</u> 33 | 3.3V      | -40° to +125°C       | 5-Pin SOT23 | Pb-Free     |
| MIC5225-5.0YM5 | <u>QT</u> 50 | 5.0V      | -40° to +125°C       | 5-Pin SOT23 | Pb-Free     |
| MIC5225YM5     | <u>QT</u> A  | Adj.      | -40° to +125°C       | 5-Pin SOT23 | Pb-Free     |

\* Under bar symbol (   ) may not be to scale.

\*\* For other voltage options available. Contact Micrel Marketing for details.

## Pin Configuration

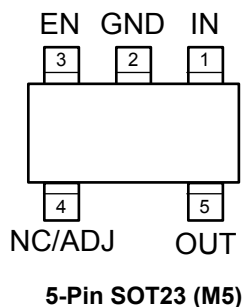

## Pin Description

| Pin Number | Pin Name     | Pin Function  |
|------------|--------------|---|
| 1          | IN           | Supply Input.   |
| 2          | GND          | Ground.   |
| 3          | EN           | Enable (Input): Logic Low or Open = Shutdown; Logic High = Enable.            |
| 4          | NC (Fixed)   | No Connect.   |
|            | ADJ (Adjust) | Adjust (Input): Feedback input. Connect to resistive voltage-divider network. |
| 5          | OUT          | Regulator Output.   |

**Absolute Maximum Ratings<sup>(1)</sup>**

|                                |                    |
|--------------------------------|--------------------|
| Supply Voltage ( $V_{IN}$ )    | –20V to 18V        |
| Enable Voltage ( $V_{EN}$ )    | –0.3V to 18V       |
| Power Dissipation ( $P_D$ )    | Internally Limited |
| Junction Temperature ( $T_J$ ) | –40°C to +125°C    |
| Storage Temperature ( $T_S$ )  | –65°C to +150°C    |
| ESD                            | <b>Note 3</b>      |

**Operating Ratings<sup>(2)</sup>**

|                                |                 |
|--------------------------------|-----------------|
| Supply Voltage ( $V_{IN}$ )    | 2.3V to 16V     |
| Enable Voltage ( $V_{EN}$ )    | 0V to 16V       |
| Junction Temperature ( $T_J$ ) | –40°C to +125°C |
| Package Thermal Resistance     |                 |
| SOT23-5 ( $\theta_{JA}$ )      | 235°C/W         |

**Electrical Characteristics<sup>(4)</sup>**

$T_A = 25^\circ\text{C}$  with  $V_{IN} = V_{OUT} + 1\text{V}$ ; Load = 100 $\mu\text{A}$ ; **bold** values indicate  $-40^\circ\text{C} \leq T_J \leq +125^\circ\text{C}$ , unless otherwise specified.

| Parameter                                 | Condition   | Min  | Typ  | Max  | Units         |
|---|---|------|------|------|---------------|
| Output Voltage Accuracy                   | Variation from nominal $V_{OUT}$                  | –1.0 |      | +1.0 | %             |
|   |   | –2.0 |      | +2.0 | %             |
| Line Regulation                           | $V_{IN} = V_{OUT} + 1\text{V}$ to 16V             |      | 0.04 |      | %             |
| Load Regulation                           | Load = 100 $\mu\text{A}$ to 150mA                 |      | 0.25 | 1    | %             |
| Dropout Voltage                           | Load = 100 $\mu\text{A}$                          |      | 50   |      | mV            |
|   | Load = 50mA                                       |      | 230  | 300  | mV            |
|   | Load = 150mA                                      |      | 310  | 450  | mV            |
| Reference Voltage                         |   | 1.22 | 1.24 | 1.26 |               |
| Ground Current                            | Load = 100 $\mu\text{A}$                          |      | 29   | 50   | $\mu\text{A}$ |
|   | Load = 50mA                                       |      | 0.5  | 0.9  | mA            |
|   | Load = 150mA                                      |      | 3    | 5    | mA            |
| Ground Current in Shutdown                | $V_{EN} \leq 0.6\text{V}$ ; $V_{IN} = 16\text{V}$ |      | 0.1  | 5    | $\mu\text{A}$ |
| Short Circuit Current                     | $V_{OUT} = 0\text{V}$                             |      | 300  | 500  | mA            |
| Output Leakage,<br>Reverse Polarity Input | Load = 500 $\Omega$ ; $V_{IN} = -15\text{V}$      |      | –0.1 |      | $\mu\text{A}$ |
| <b>Enable Input</b>                       |   |      |      |      |               |
| Input Low Voltage                         | Regulator OFF                                     |      |      | 0.6  | V             |
| Input High Voltage                        | Regulator ON                                      | 2.0  |      |      | V             |
| Enable Input Current                      | $V_{EN} = 0.6\text{V}$ ; Regulator OFF            | –1.0 | 0.01 | +1.0 | $\mu\text{A}$ |
|   | $V_{EN} = 2.0\text{V}$ ; Regulator ON             |      | 0.15 | 1.0  | $\mu\text{A}$ |
|   | $V_{EN} = 16\text{V}$ ; Regulator ON              |      | 0.5  | 2.5  | $\mu\text{A}$ |

**Notes:**

- Exceeding the absolute maximum rating may damage the device.
- The device is not guaranteed to function outside its operating rating.
- Devices are ESD sensitive. Handling precautions recommended. Human body model, 1.5k $\Omega$  in series with 100pF.
- Specification for packaged product only.

# Typical Characteristics

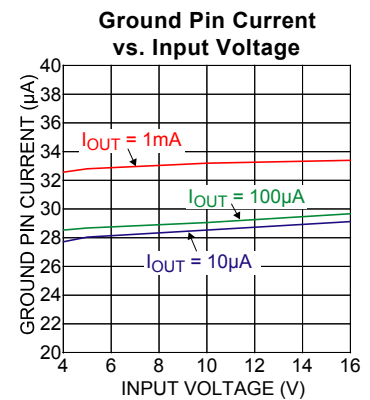
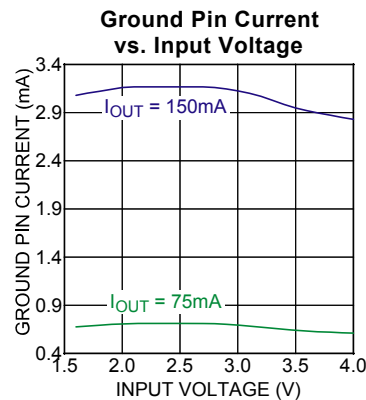
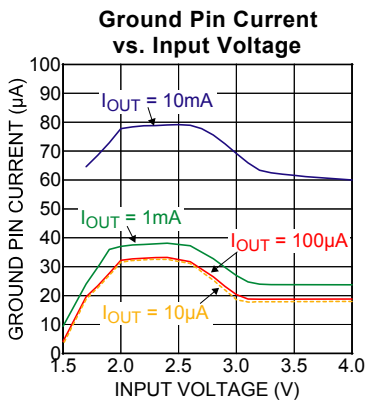
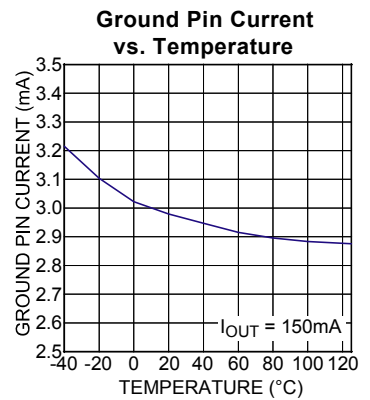
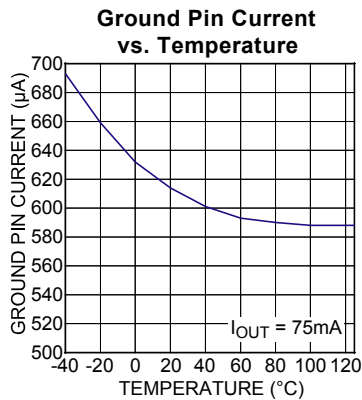
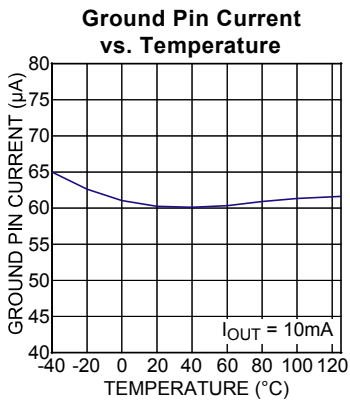
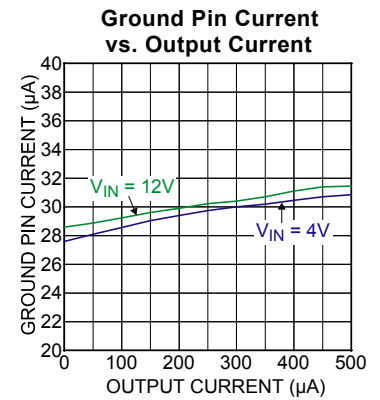
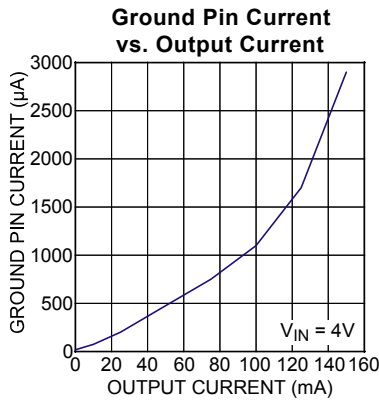
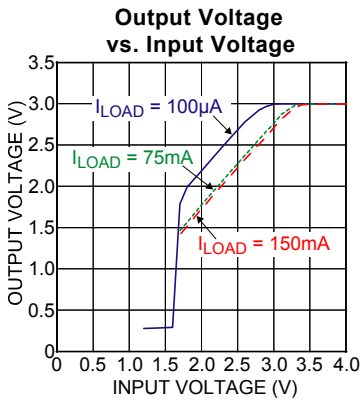
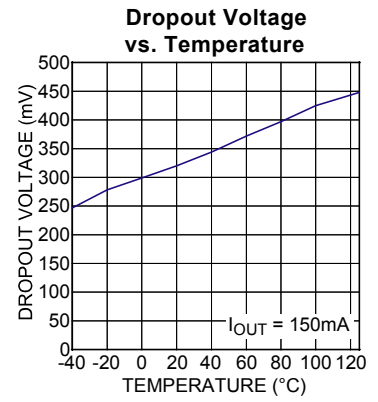
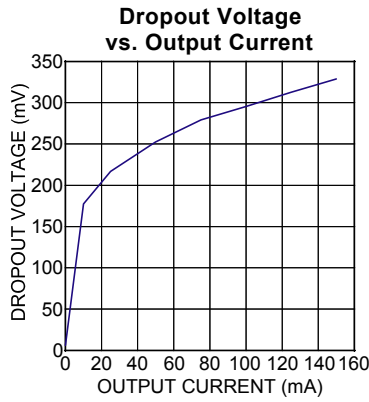
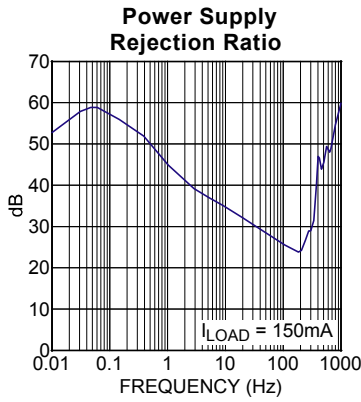

### Typical Characteristics (continued)

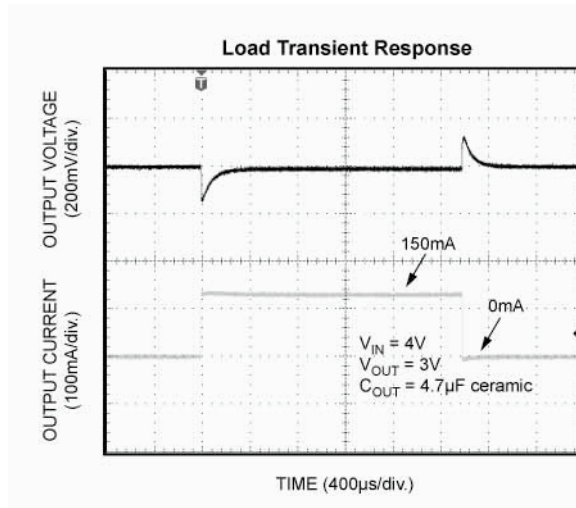
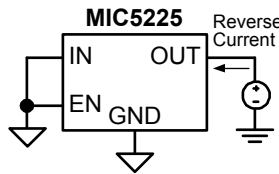
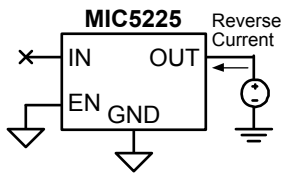
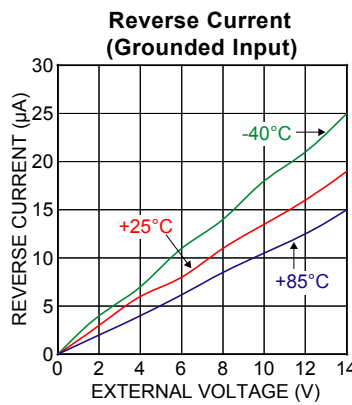
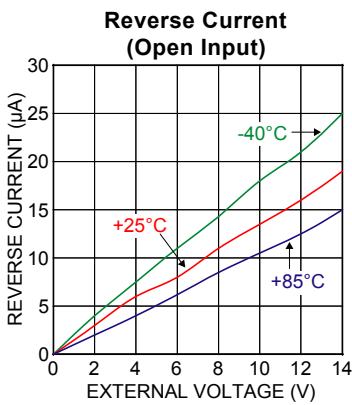
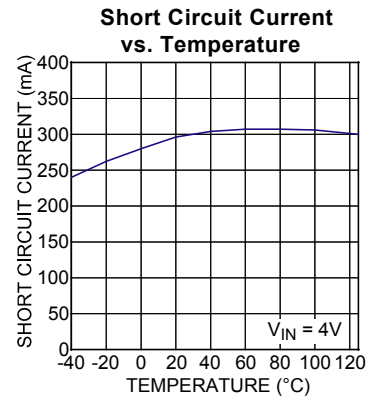
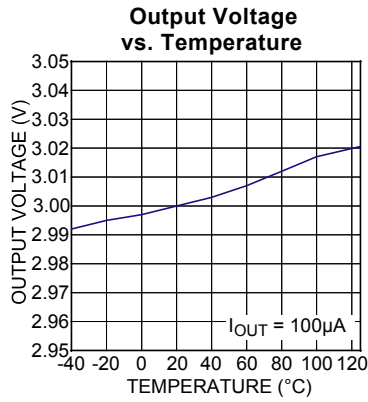
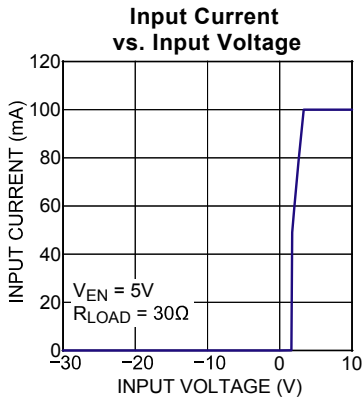

### Functional Diagram

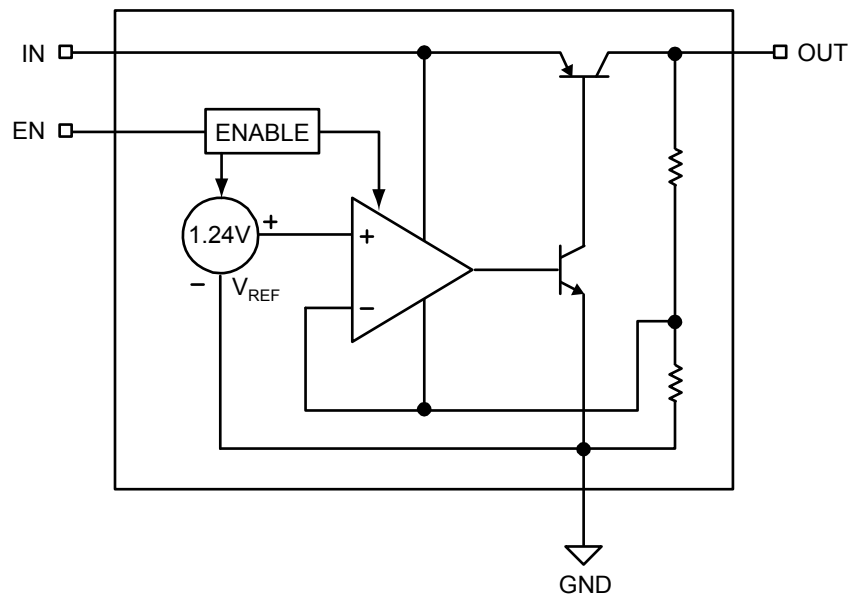

**Block Diagram – Fixed Output Voltage**

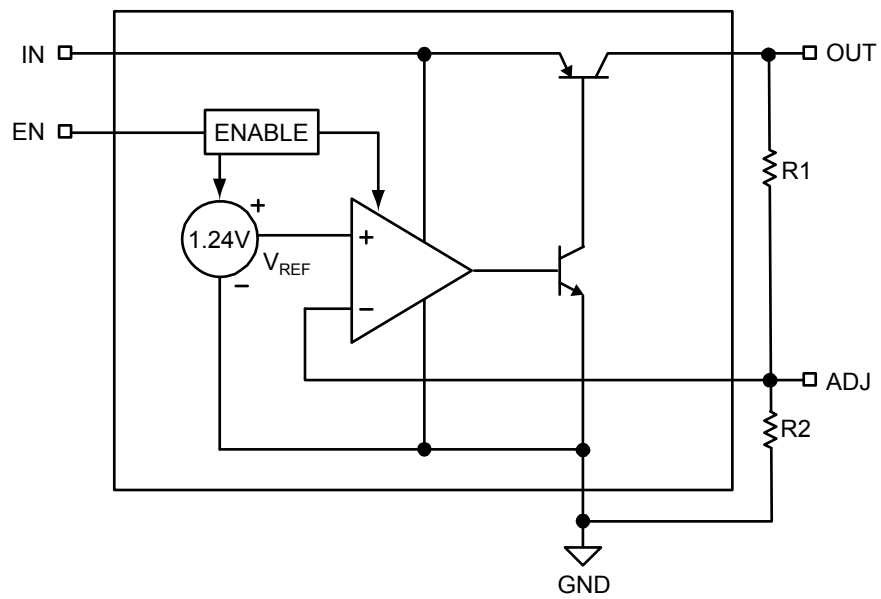

**Block Diagram – Adjustable Output Voltage**

## Application Information

### Enable/Shutdown

The MIC5225 comes with an active-high enable pin that allows the regulator to be disabled. Forcing the enable pin low disables the regulator and sends it into a “zero” off-mode current state. In this state, current consumed by the regulator goes nearly to zero. Forcing the enable pin high enables the output voltage.

### Input Capacitor

The MIC5225 has a wide input voltage capability up to 16V. The input capacitor must be rated to sustain voltages that may be used on the input. An input capacitor may be required when the device is not near the source power supply or when supplied by a battery. Small, surface mount, ceramic capacitors can be used for bypassing. Larger value may be required if the source supply has high ripple.

### Output Capacitor

The MIC5225 requires an output capacitor for stability. The design requires 1.0 $\mu$ F or greater on the output to maintain stability. The design is optimized for use with low-ESR ceramic chip capacitors. High ESR capacitors may cause high frequency oscillation. The maximum recommended ESR is 300m $\Omega$ . The output capacitor can be increased, but performance has been optimized for a 1.0 $\mu$ F ceramic output capacitor and does not improve significantly with the use of a larger capacitor.

X7R/X5R dielectric-type ceramic capacitors are recommended because of their temperature performance. X7R-type capacitors change capacitance by 15% over their operating temperature range and are the most stable type of ceramic capacitors. Z5U and Y5V dielectric capacitors change value by as much as 50% and 60% respectively over their operating temperature ranges. To use a ceramic chip capacitor with Y5V dielectric, the value must be much higher than an X7R ceramic capacitor to ensure the same minimum capacitance over the equivalent operating temperature range.

### No-Load Stability

The MIC5225 will remain stable and in regulation with no load unlike many other voltage regulators. This is especially important in CMOS RAM keep-alive applications.

## Thermal Consideration

The MIC5225 is designed to provide 150mA of continuous current in a very small package. Maximum power dissipation can be calculated based on the output current and the voltage drop across the part. To determine the maximum power dissipation of the package, use the junction-to-ambient thermal resistance of the device and the following basic equation:

$$P_{D(MAX)} = (T_{J(MAX)} - T_A) / \theta_{JA}$$

$T_{J(MAX)}$  is the maximum junction temperature of the die, 125°C, and  $T_A$  is the ambient operating temperature.  $\theta_{JA}$  is layout dependent; Table 1 shows examples of the junction-to-ambient thermal resistance for the MIC5225.

| Package  | $\theta_{JA}$ Recommended Minimum Footprint |
|----------|---|
| SOT-23-5 | 235°C/W                                     |

Table 1. SOT-23-5 Thermal Resistance

The actual power dissipation of the regulator circuit can be determined using the equation:

$$P_D = (V_{IN} - V_{OUT})I_{OUT} + V_{IN}I_{GND}$$

Substituting  $P_{D(MAX)}$  for  $P_D$  and solving for the operating conditions that are critical to the application will give the maximum operating conditions for the regulator circuit. For example, when operating the MIC5225-3.0BMM at 50°C with a minimum footprint layout, the maximum input voltage for a set output current can be determined as follows:

$$P_{D(MAX)} = (125^\circ\text{C} - 50^\circ\text{C}) / 235^\circ\text{C/W}$$

$$P_{D(MAX)} = 319\text{mW}$$

The junction-to-ambient thermal resistance for the minimum footprint is 235°C/W, from Table 1. The maximum power dissipation must not be exceeded for proper operation. Using the output voltage of 3.0V, and an output current of 150mA, the maximum input voltage can be determined.

$$319\text{mW} = (V_{IN} - 3.0\text{V})150\text{mA} + V_{IN} \times 3.0\text{mA}$$

$$319\text{mW} = V_{IN} \times 153\text{mA} - 450\text{mW}$$

$$769\text{mW} = V_{IN} \times 153\text{mA}$$

$$V_{IN(MAX)} = 5.02\text{V}$$

Therefore, a 3.0V application at 150mA of output current can accept a maximum input voltage of 5.02V in the SOT-23-5 package. For a full discussion of heat sinking and thermal effects on the voltage regulators, refer to the Regulator Thermals section of Micrel's *Designing with Low-Dropout Voltage Regulators* handbook: [http://www.onfulfillment.com/estore/pdf\\_download.asp?s=2243381&p=18&pdf=842935-iecjdf-bicadii](http://www.onfulfillment.com/estore/pdf_download.asp?s=2243381&p=18&pdf=842935-iecjdf-bicadii)

### Adjustable Regulator Application

The MIC5225YM5 can be adjusted from 1.24V to 14V by using two external resistors (Figure 1). The resistors set the output voltage based on the following equation:

$$V_{OUT} = V_{REF}(1 + (R_1/R_2)),$$

Where  $V_{REF} = 1.24V$ .

Feedback resistor R2 should be no larger than 300k $\Omega$ .

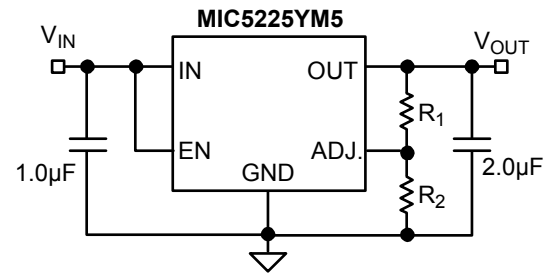
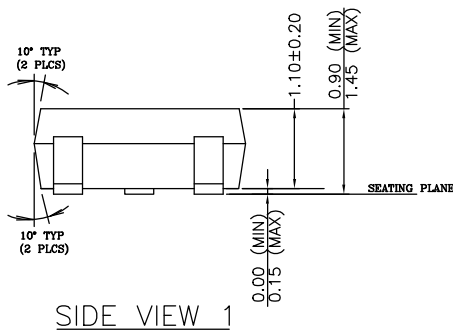
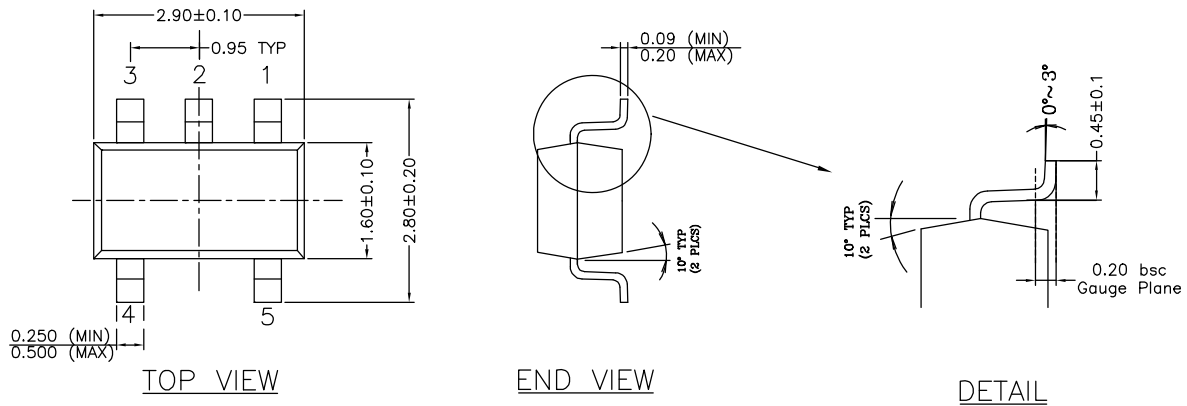

Figure 1. Adjustable Voltage Application

### Package Information



- NOTE:
1. PACKAGE OUTLINE EXCLUSIVE OF MOLD FLASH & BURR.
  2. PACKAGE OUTLINE INCLUSIVE OF SOLER PLATING.
  3. DIMENSION AND TOLERANCE PER ANSI Y14.5M, 1982.
  4. FOOT LENGTH MEASUREMENT BASED ON GAUGE PLANE METHOD.
  5. DIE FACES UP FOR MOLD, AND FACES DOWN FOR TRIM/FORM.
  6. ALL DIMENSIONS ARE IN MILLIMETERS.

### 5-Pin SOT23 (M5)

**MICREL, INC. 2180 FORTUNE DRIVE SAN JOSE, CA 95131 USA**  
 TEL +1 (408) 944-0800 FAX +1 (408) 474-1000 WEB <http://www.micrel.com>

The information furnished by Micrel in this data sheet is believed to be accurate and reliable. However, no responsibility is assumed by Micrel for its use. Micrel reserves the right to change circuitry and specifications at any time without notification to the customer.

Micrel Products are not designed or authorized for use as components in life support appliances, devices or systems where malfunction of a product can reasonably be expected to result in personal injury. Life support devices or systems are devices or systems that (a) are intended for surgical implant into the body or (b) support or sustain life, and whose failure to perform can be reasonably expected to result in a significant injury to the user. A Purchaser's use or sale of Micrel Products for use in life support appliances, devices or systems is a Purchaser's own risk and Purchaser agrees to fully indemnify Micrel for any damages resulting from such use or sale.

© 2007 Micrel, Incorporated.

## Looking for pricing, stock, or lifecycle information?

Click below to explore more details on WIN SOURCE:

- ⊖ [View MIC5225-1.5YM5-TR on WIN SOURCE](#)
- ⊖ [Microchip Technology](#) Information

## Optimize Your Supply Chain with WIN SOURCE Solutions

- ✓ Global Sourcing Solution
- ✓ Obsolete Management
- ✓ Cost Control Management
- ✓ Shortage Management
- ✓ Alternative Solution
- ✓ Excess Inventory Management