

μCap Negative Low Dropout Regulator

Features

- Stable with Ceramic or Tantalum Capacitors
- Standard Fixed Output Voltage Options: 3.0V and 5.0V
- Adjustable Output Voltage Option: (–1.2V to –14V)
- Positive and Negative Enable Thresholds
- Low Dropout Voltage: –500 mV @ –100 mA
- Low Ground Current: –25 μA @ Load = –100 μA
- Tight Initial Accuracy: ±2%
- Tight Load and Line Regulation
- Thermal Shutdown and Current-Limit Protection
- IttyBitty 5-Pin SOT23 Packaging
- Zero-Current Off Mode

Applications

- GaAsFET Bias
- Portable Cameras and Video Recorders
- PDAs
- Battery-Powered Equipment
- Post-Regulation of DC/DC Converters

General Description

The MIC5271 is a μCap 100 mA negative regulator in a SOT23-5 package. With better than 2% initial accuracy, this regulator provides a very accurate supply voltage for applications that require a negative rail. The MIC5271 sinks 100 mA of output current at very low dropout voltage (500 mV typical, 700 mV maximum at 100 mA of output current).

The μCap regulator design is optimized to work with low-value, low-cost ceramic capacitors. The output typically requires only a 1 μF capacitance for stability.

Designed for applications where small packaging and efficiency are critical, the MIC5271 combines LDO design expertise with IttyBitty packaging to improve performance and reduce power dissipation. Ground current is optimized to help improve battery life in portable applications. The MIC5271 also includes a TTL-compatible enable pin, allowing the user to put the part into a zero-current off mode, in which the ground current is only ±1 μA, typical.

The MIC5271 is available in the 5-pin SOT23 package for space saving applications and it is available with an adjustable output.

Package Types

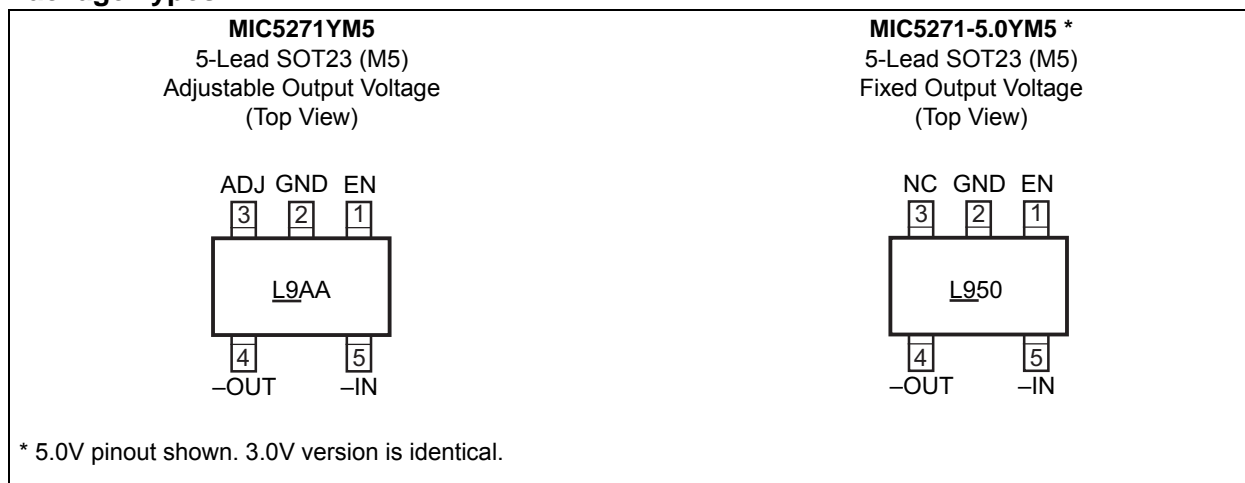

Please see pin descriptions in [Table 3-1](#).

MIC5271

Typical Application Circuit

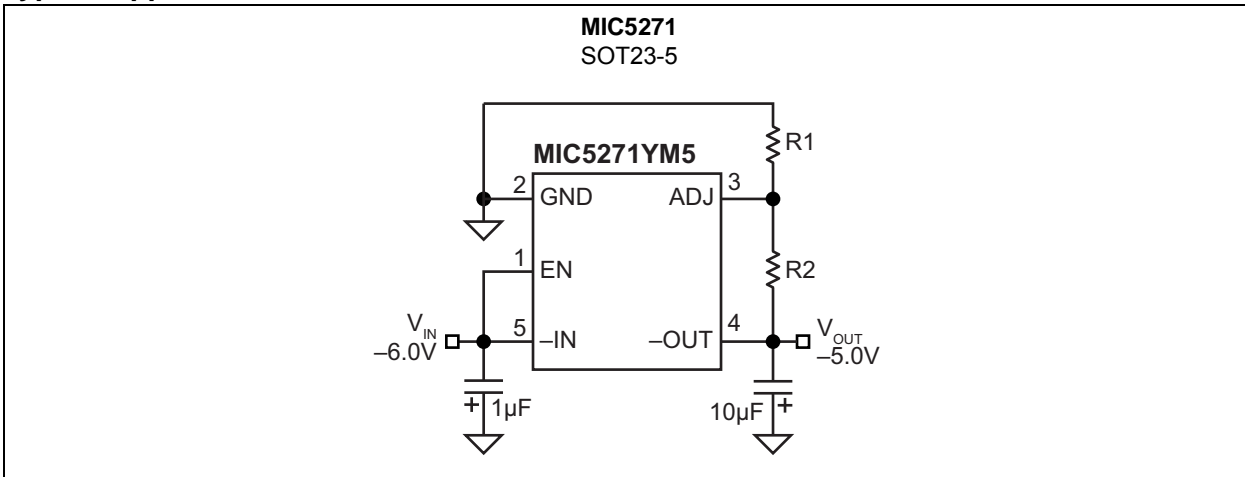

Functional Block Diagram

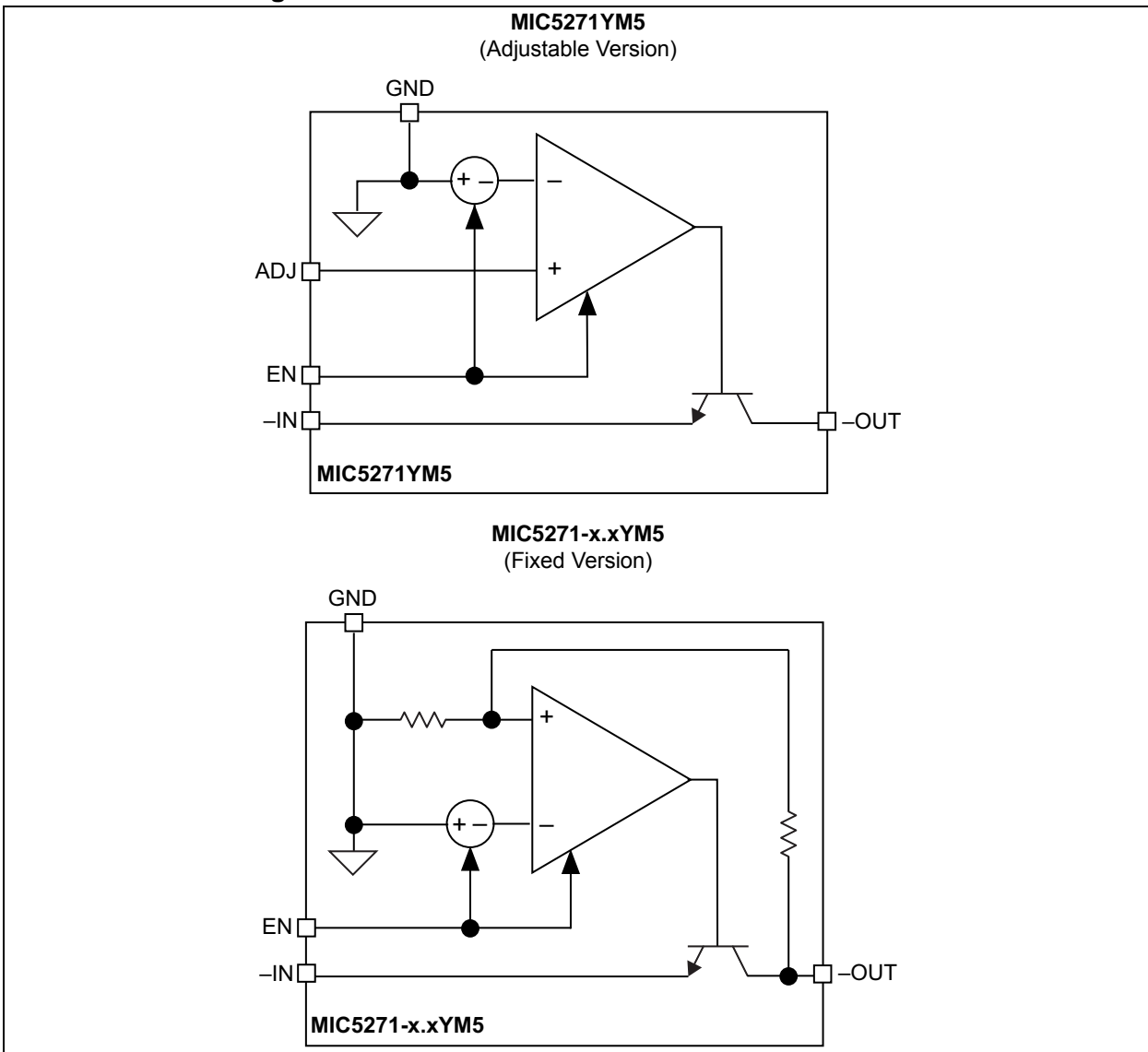

1.0 ELECTRICAL CHARACTERISTICS

Absolute Maximum Ratings †

Input Voltage (V_{-IN})	-20V to +0.3V
Enable Voltage (V_{EN})	-20V to +20V
Power Dissipation	Internally Limited
ESD Rating	Note 1

Operating Ratings ‡

Input Voltage (V_{-IN})	-16V to -3.3V
Enable Voltage (V_{EN})	-16V to +16V

† **Notice:** Stresses above those listed under “Absolute Maximum Ratings” may cause permanent damage to the device. This is a stress rating only and functional operation of the device at those or any other conditions above those indicated in the operational sections of this specification is not intended. Exposure to maximum rating conditions for extended periods may affect device reliability.

‡ **Notice:** The device is not guaranteed to function outside its operating ratings.

Note 1: Devices are ESD sensitive. Handling precautions recommended.

MIC5271

TABLE 1-1: ELECTRICAL CHARACTERISTICS

Electrical Characteristics: $V_{-IN} = V_{-OUT} - 1.0V$; $C_{OUT} = 4.7 \mu F$, $I_{OUT} = 100 \mu A$; $T_J = +25^\circ C$, **bold** values indicate $-40^\circ C \leq T_J \leq +125^\circ C$; unless otherwise noted. [Note 1](#)

Parameter	Symbol	Min.	Typ.	Max.	Units	Conditions	
Output Voltage Accuracy	V_{-OUT}	-2	—	2	%	Variation from nominal V_{-OUT} .	
		-3	—	3			
Output Voltage Temperature Coefficient	$\Delta V_{-OUT}/\Delta T$	—	100	—	ppm/ $^\circ C$	Note 2	
Line Regulation	$\Delta V_{-OUT}/V_{-OUT}$	—	0.04	0.15	%/V	$V_{-IN} = V_{-OUT} - 1V$ to $-16V$	
				0.2			
Load Regulation	$\Delta V_{-OUT}/V_{-OUT}$	—	0.4	1.8	%	$I_{OUT} = -100 \mu A$ to $-100 mA$, Note 3	
				2.0			
Dropout Voltage, Note 4	$V_{-IN} - V_{-OUT}$	—	-55	—	mV	$I_{OUT} = -100 \mu A$	
				-360		-500	$I_{OUT} = -50 mA$
				-500		-700	$I_{OUT} = -100 mA$
						-900	
Ground Current, Note 5	I_{GND}	—	-25	-100	μA	$I_{OUT} = -100 \mu A$	
				-0.9		—	$I_{OUT} = -50 mA$
				-2.0		-3.0	$I_{OUT} = -100 mA$
Ground Current in Shutdown	I_{GND_SD}	-1.0	0.1	1.0	μA	$V_{EN} = \pm 0.6V$	
Ripple Rejection	PSRR	—	50	—	dB	$f = 120 Hz$	
Current Limit	I_{LIMIT}	—	235	350	mA	$V_{-OUT} = 0V$	
Turn-On Time	t_{ON}	—	60	—	μs	Time to $V_{OUT} = 90%$ (nominal)	
Input Low Voltage	V_{EN}	—	—	± 0.6	V	Regulator OFF	
Input High Voltage				± 2.0		—	—
Enable Input Current	I_{EN}	—	—	0.1	μA	$V_{EN} = \pm 0.6V$ and $-2.0V$	
				5.6		10.0	$V_{EN} = +2.0V$

Note 1: Specification for packaged product only

2: Output voltage temperature coefficient is defined as the worst case voltage change divided by the total temperature range.

3: Regulation is measured at constant junction temperature using low duty cycle pulse testing. Parts are tested for load regulation in the load range from $100 \mu A$ to $100 mA$. Changes in output voltage due to heating effects are covered by the thermal regulation specification.

4: Dropout voltage is defined as the input to output differential at which the output voltage drops 2% below its nominal value measured at 1V differential.

5: Ground pin current is the regulator quiescent current plus pass transistor base current. The total current drawn from the supply is the sum of the load current plus the ground pin current.

TEMPERATURE SPECIFICATIONS (Note 1)

Parameters	Sym.	Min.	Typ.	Max.	Units	Conditions
Temperature Ranges						
Junction Temperature Range	T_J	-40	—	+125	°C	—
Storage Temperature Range	T_S	-65	—	+150	°C	—
Lead Temperature	—	—	—	+260	°C	Soldering, 10s
Package Thermal Resistances						
Thermal Resistance SOT23-5	θ_{JA}	—	235	—	°C/W	—

- Note 1:** The maximum allowable power dissipation is a function of ambient temperature, the maximum allowable junction temperature and the thermal resistance from junction to air (i.e., T_A , T_J , θ_{JA}). Exceeding the maximum allowable power dissipation will cause the device operating junction temperature to exceed the maximum +125°C rating. Sustained junction temperatures above +125°C can impact the device reliability.
- 2:** The maximum allowable power dissipation is a function of the maximum junction temperature, $T_{J(MAX)}$, the junction-to-ambient thermal resistance, θ_{JA} , and the ambient temperature, T_A . The maximum allowable power dissipation at any ambient temperature is calculated using: $P_{D(MAX)} = (T_{J(MAX)} - T_A) \div \theta_{JA}$, where θ_{JA} is 235°C/W. Exceeding the maximum allowable power dissipation will result in excessive die temperature, and the regulator will go into thermal shutdown. See the “Thermal Considerations” sub-section in the Application Information for details.

MIC5271

2.0 TYPICAL PERFORMANCE CURVES

Note: The graphs and tables provided following this note are a statistical summary based on a limited number of samples and are provided for informational purposes only. The performance characteristics listed herein are not tested or guaranteed. In some graphs or tables, the data presented may be outside the specified operating range (e.g., outside specified power supply range) and therefore outside the warranted range.

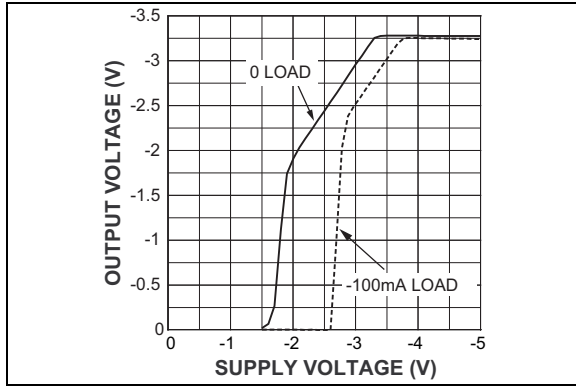

FIGURE 2-1: Dropout Characteristics.

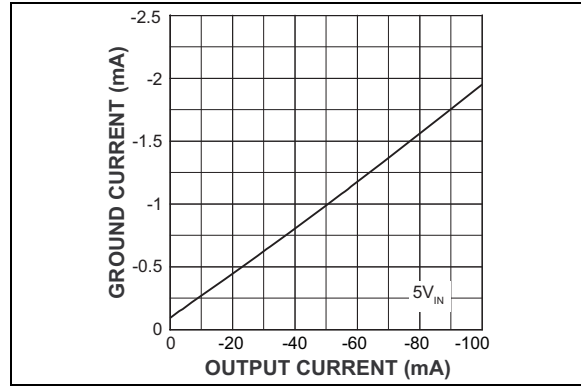

FIGURE 2-4: Ground Current vs. Output Current.

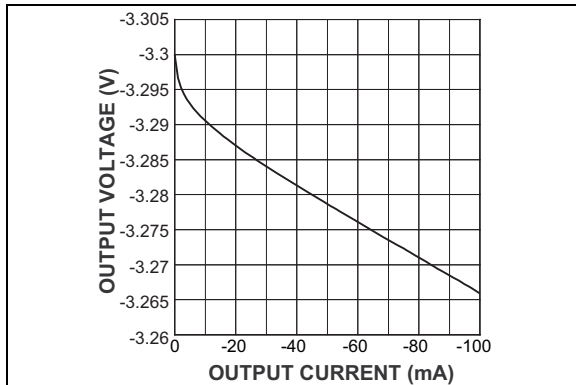

FIGURE 2-2: Output Voltage vs. Output Current.

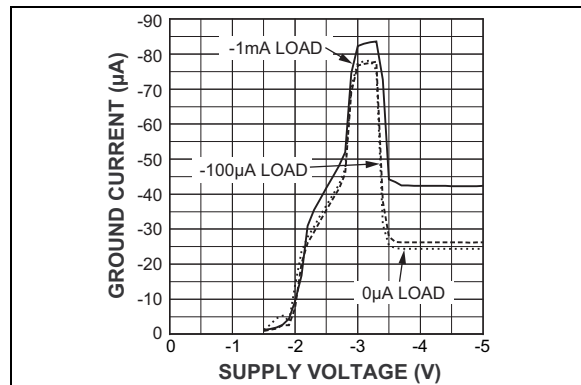

FIGURE 2-5: Ground Current vs. Input Voltage.

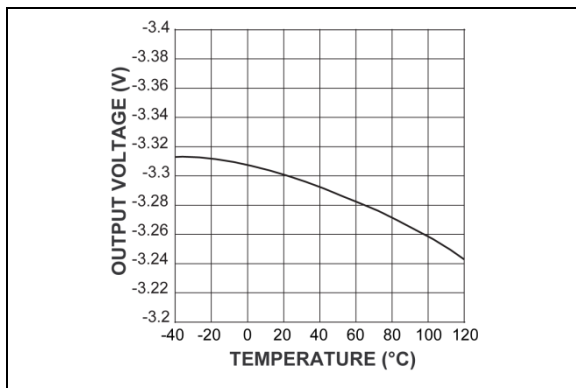

FIGURE 2-3: Output Voltage vs. Temperature.

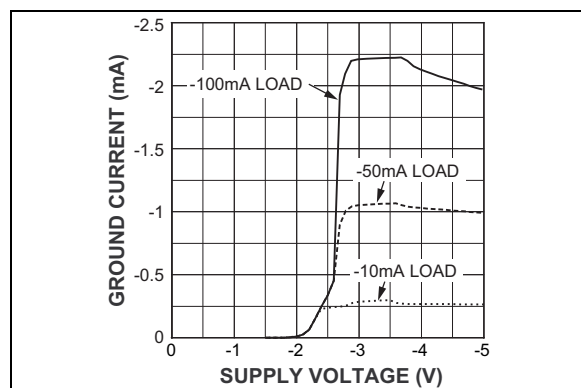

FIGURE 2-6: Ground Current vs. Input Voltage.

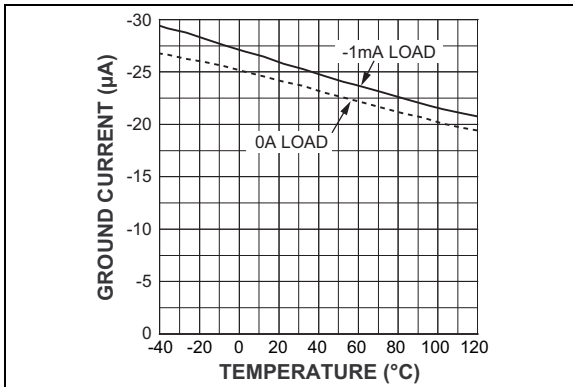

FIGURE 2-7: Ground Current vs. Temperature.

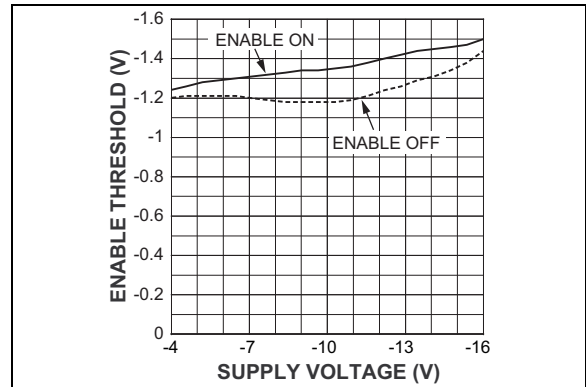

FIGURE 2-10: Negative Enable Threshold vs. Supply Voltage.

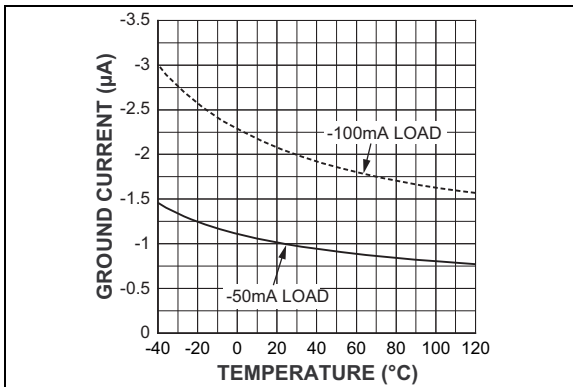

FIGURE 2-8: Ground Current vs. Temperature.

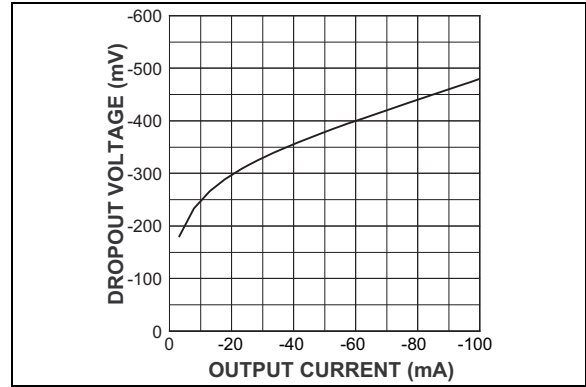

FIGURE 2-11: Dropout Voltage vs. Output Current.

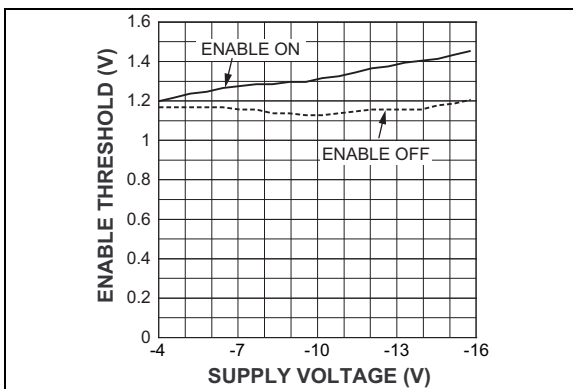

FIGURE 2-9: Positive Enable Threshold vs. Supply Voltage.

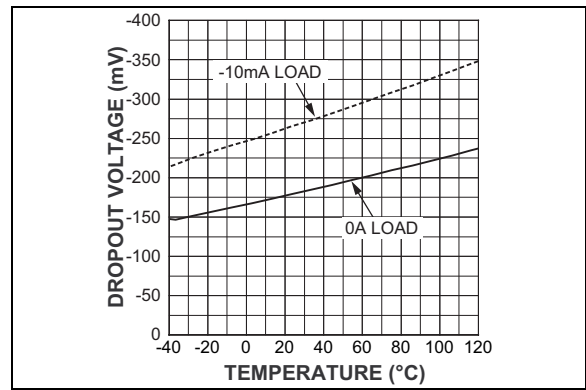

FIGURE 2-12: Dropout Voltage vs. Temperature.

MIC5271

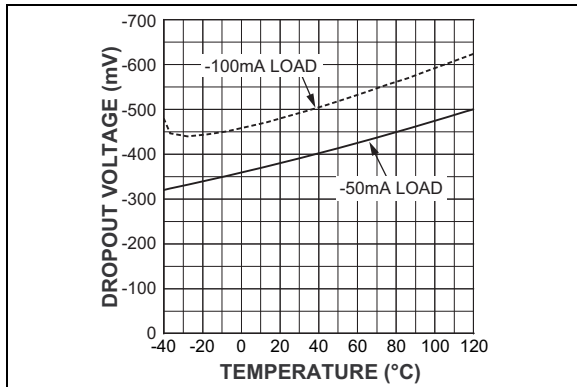

FIGURE 2-13: Dropout Voltage vs. Temperature.

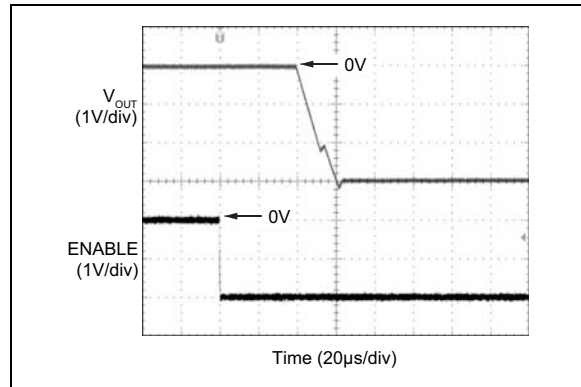

FIGURE 2-16: Negative Enable Transient.

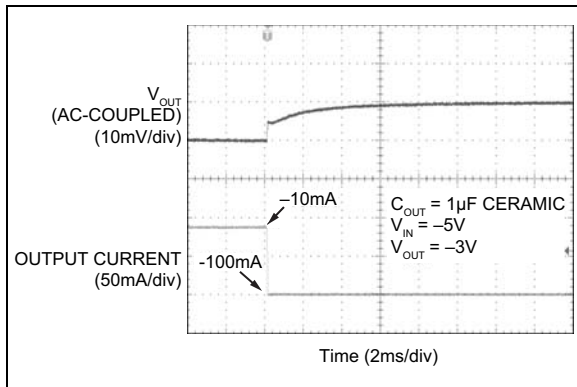

FIGURE 2-14: Load Transient.

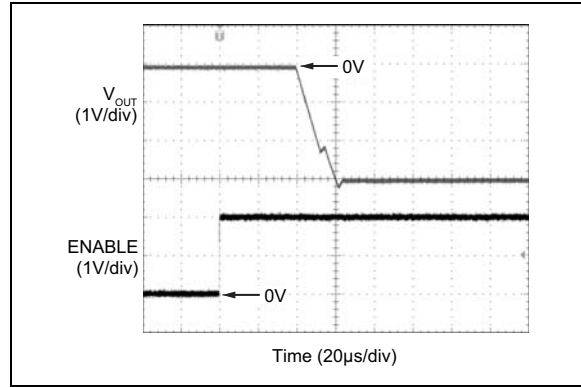

FIGURE 2-17: Positive Enable Transient.

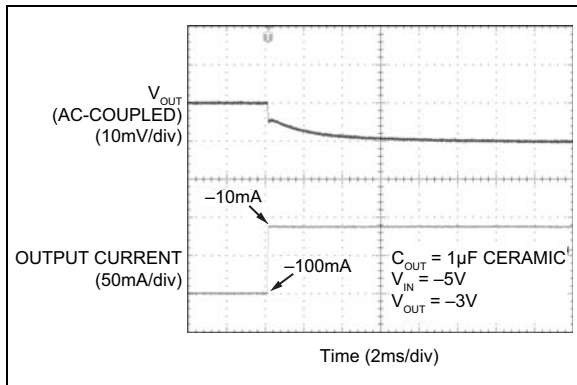

FIGURE 2-15: Load Transient.

3.0 PIN DESCRIPTIONS

The descriptions of the pins are listed in [Table 3-1](#).

TABLE 3-1: PIN FUNCTION TABLE

Pin Number Adjustable	Pin Number Fixed	Pin Name	Description
1	1	EN	Enable Input. TTL logic-compatible enable input. Logic HIGH = ON, Logic LOW or open = OFF.
2	2	GND	Ground.
3	—	ADJ	Adjustable (Input): Adjustable feedback output connects to resistor voltage divider.
—	3	NC	No Connect. Leave unconnected.
4	4	–OUT	Negative Regulator Output.
5	5	–IN	Negative Supply Input.

MIC5271

4.0 APPLICATION INFORMATION

The MIC5271 is a general-purpose negative voltage regulator that can be used in a system that requires a clean negative voltage. This includes the post regulation of DC/DC converters (transformer or charge pump based voltage converters). These negative voltages typically require a negative low dropout voltage regulator to provide a clean output from noisy input power.

4.1 Input Capacitor

A 1 μF input capacitor should be placed from $-\text{IN}$ to GND if there is more than two inches of wire or trace between the input and the AC filter capacitor or if a battery is used as the input.

4.2 Output Capacitor

The MIC5271 requires an output capacitor for stable operation. A minimum of 1 μF of output capacitance is required. The output capacitor can be increased without limitation to improve transient response. The output does not require ESR to maintain stability; therefore a ceramic capacitor can be used. High-ESR capacitors may cause instability. Capacitors with an ESR of 3 Ω or greater at 100 kHz can cause a high-frequency oscillation.

Low-ESR tantalums are recommended due to the tight capacitance tolerance over temperature. The Z5U dielectric can change capacitance value by as much 50% over temperature, and the Y5V dielectric can change capacitance value by as much as 60% over temperature. To use a ceramic chip capacitor with the Y5V dielectric, the value must be much higher than a tantalum to ensure the same minimum capacitor value over temperature.

4.3 No-Load Stability

The MIC5271 does not require a load for stability.

4.4 Enable Input

The MIC5271 comes with an enable pin that allows the regulator to be disabled. Forcing the enable pin higher than the negative threshold and lower than the positive threshold disables the regulator and sends it into a “zero” off-mode current state. In this state, current consumed by the regulator goes nearly to zero, typically drawing only $\pm 1 \mu\text{A}$. The MIC5271 will be in the “on” mode when the voltage applied to the enable pin is either greater than the positive threshold or less than the negative threshold.

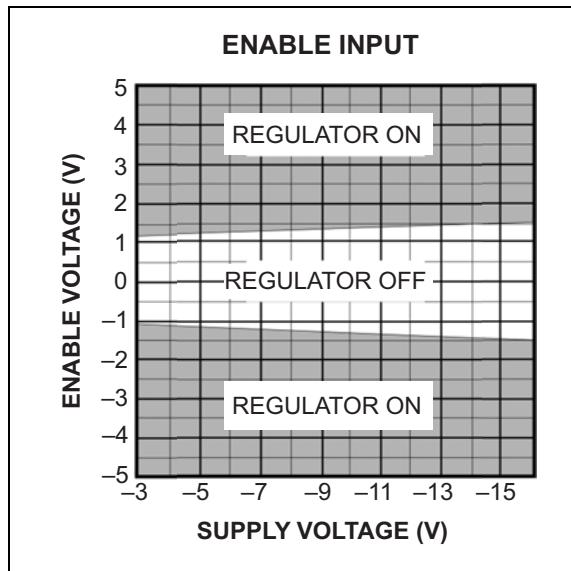

FIGURE 4-1: Positive and Negative Enable Voltage vs. Supply Voltage.

4.5 Thermal Considerations

Absolute values will be used for thermal calculations to clarify the meaning of power dissipation and voltage drops across the part.

Proper thermal design for the MIC5271-5.0YM5 can be accomplished with some basic design criteria and some simple equations. The following information must be known to implement your regulator design:

- V_{IN} = Input voltage
- V_{OUT} = Output voltage
- I_{OUT} = Output current
- T_{A} = Ambient operating temperature
- I_{GND} = Ground current

Maximum power dissipation can be determined by knowing the ambient temperature (T_{A}), the maximum junction temperature (+125°C), and the thermal resistance (junction-to-ambient). The thermal resistance for this part, assuming a minimum footprint board layout, is +235°C/W. The maximum power dissipation at an ambient temperature of +25°C can be determined with [Equation 4-1](#) and [Equation 4-2](#):

EQUATION 4-1:

$$P_{D(MAX)} = \frac{T_{J(MAX)} - T_A}{\theta_{JA}}$$

EQUATION 4-2:

$$P_{D(MAX)} = \frac{125^{\circ}C - 25^{\circ}C}{235^{\circ}C/W} = 425mW$$

The actual power dissipation of the regulator circuit can be determined using Equation 3:

EQUATION 4-3:

$$P_D = (V_{IN} - V_{OUT}) \times I_{OUT} + (V_{IN} \times I_{GND})$$

Substituting $P_{D(MAX)}$, determined above, for P_D and solving for the operating conditions that are critical to the application will give the maximum operating conditions for the regulator circuit. The maximum power dissipation number cannot be exceeded for proper operation of the device. The maximum input voltage can be determined using the output voltage of 5.0V and an output current of 100 mA. Ground current, of 2 mA for 100 mA of output current, can be taken from [Table 1-1](#).

- $425\text{ mW} = (V_{IN} - 5.0V) \times 100\text{ mA} + V_{IN} \times 2\text{ mA}$
- $425\text{ mW} = (100\text{ mA} \times V_{IN} + 2\text{ mA} \times V_{IN}) - 500\text{mW}$
- $925\text{ mW} = 102\text{ mA} \times V_{IN}$
- $V_{IN} = 9.07V$ (maximum)

Therefore, a $-5.0V$ application at -100 mA of output current can accept a maximum input voltage of $-9.07V$ in a SOT-23 package. For a full discussion of heat sinking and thermal effects on voltage regulators, refer to "Regulator Thermals" section of Microchip's [Designing with Low Dropout Voltage Regulators](#) handbook and [AN792, A Method to Determine How Much Power an SOT23 Can Dissipate in an Application](#).

4.6 Adjustable Regulator Application

The MIC5271YM5 can be adjusted from $-1.20V$ to $-14V$ by using two external resistors ([Figure 4-2](#)). The resistors set the output voltage based on [Equation 4-4](#).

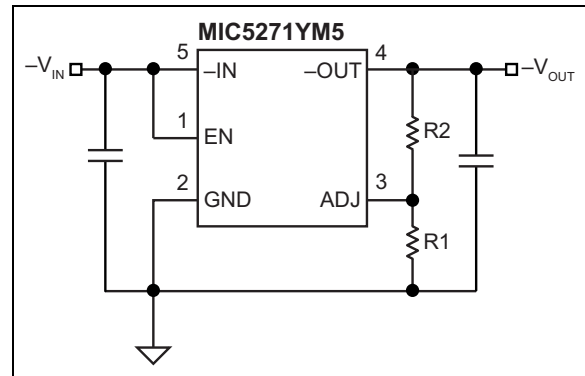

FIGURE 4-2: Adjustable Voltage Application.

EQUATION 4-4:

$$|V_{OUT}| = V_{REF} \left(1 + \frac{R2}{R1} \right)$$

Where:

$$V_{REF} = 1.20V$$

MIC5271

5.0 PACKAGING INFORMATION

5.1 Package Marking Information

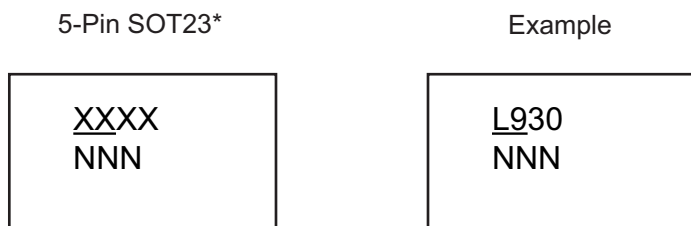

Part Number	Output Voltage	Marking
MIC5271YM5	Adjustable	L9AA
MIC5271-3.0YM5	-3.0V	L930
MIC5271-5.0YM5	-5.0V	L950

Legend: XX...X Product code or customer-specific information
Y Year code (last digit of calendar year)
YY Year code (last 2 digits of calendar year)
WW Week code (week of January 1 is week '01')
NNN Alphanumeric traceability code
(e3) Pb-free JEDEC® designator for Matte Tin (Sn)
* This package is Pb-free. The Pb-free JEDEC designator ((e3)) can be found on the outer packaging for this package.

•, ▲, ▼ Pin one index is identified by a dot, delta up, or delta down (triangle mark).

Note: In the event the full Microchip part number cannot be marked on one line, it will be carried over to the next line, thus limiting the number of available characters for customer-specific information. Package may or may not include the corporate logo.

Underbar () and/or Overbar () symbol may not be to scale.

5-Lead SOT23 Package Outline and Recommended Land Pattern

TITLE

5 LEAD SOT23 PACKAGE OUTLINE & RECOMMENDED LAND PATTERN

DRAWING #	SOT23-5LD-PL-1	UNIT	MM
------------------	----------------	-------------	----

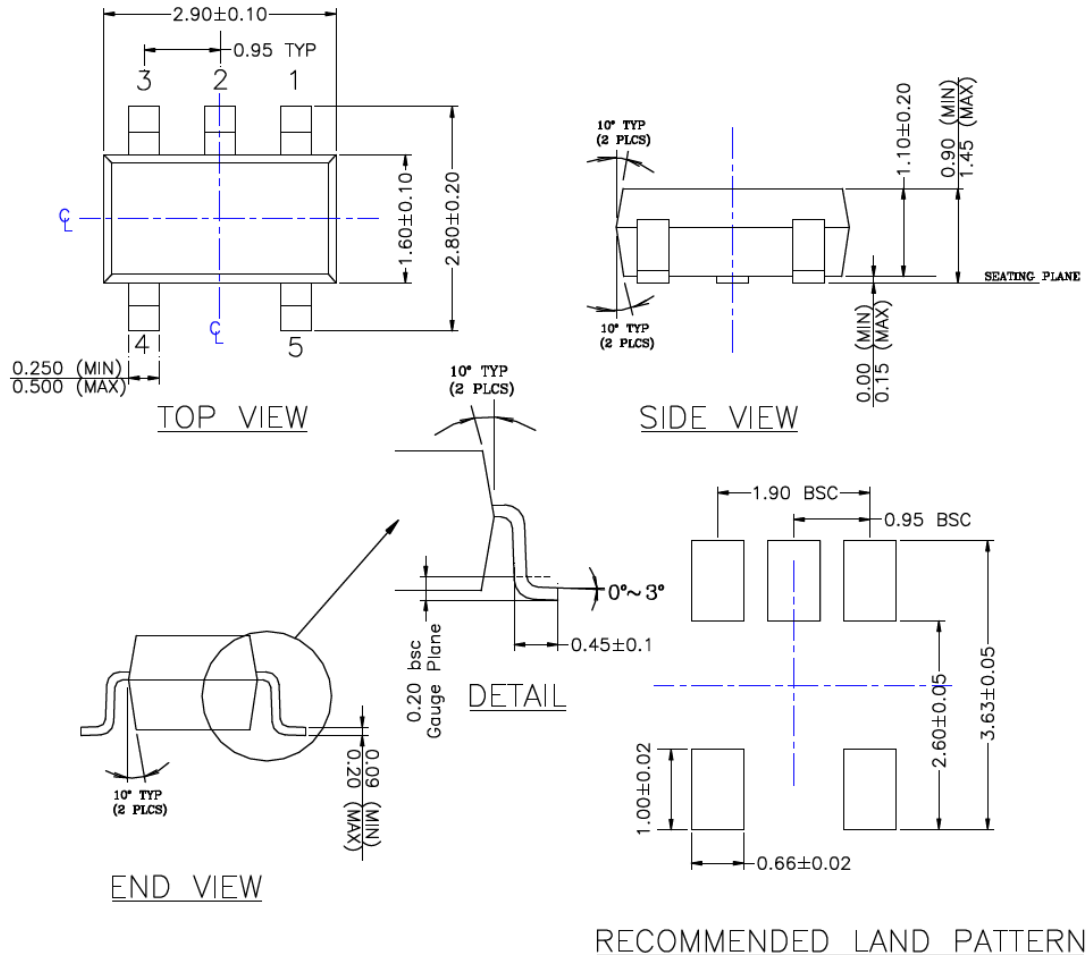

NOTE:

1. PACKAGE OUTLINE EXCLUSIVE OF MOLD FLASH & BURR.
2. PACKAGE OUTLINE INCLUSIVE OF SOLER PLATING.
3. DIMENSION AND TOLERANCE PER ANSI Y14.5M, 1982.
4. FOOT LENGTH MEASUREMENT BASED ON GAUGE PLANE METHOD.
5. DIE FACES UP FOR MOLD, AND FACES DOWN FOR TRIM/FORM.
6. ALL DIMENSIONS ARE IN MILLIMETERS.

Note: For the most current package drawings, please see the Microchip Packaging Specification located at <http://www.microchip.com/packaging>.

MIC5271

NOTES:

APPENDIX A: REVISION HISTORY

Revision A (November 2017)

- Converted Micrel document MIC5271 to Microchip data sheet DS20005881A.
- Minor text changes throughout.

MIC5271

NOTES:

PRODUCT IDENTIFICATION SYSTEM

To order or obtain information, e.g., on pricing or delivery, contact your local Microchip representative or sales office.

<u>PART NO.</u>	<u>-XX</u>	<u>X</u>	<u>X</u>	<u>-XX</u>
Device	Output Voltage	Junction Temp. Range	Package	Media Type
Device: MIC5271:	μCap Negative Low Dropout Regulator			
Output Voltage:	<blank>= Adjustable 3.0 = -3.0V Fixed Option 5.0 = -5.0V Fixed Option			
Junction Temperature Range:	Y = -40°C to +125°C, RoHS-Compliant			
Package:	M5 = 5-Lead SOT23			
Media Type:	TR = 3,000/Reel			
Note: Contact Marketing for other output voltage options.				
Examples:				
a) MIC5271YM5-TR: μCap Negative Low Dropout Regulator, Adjustable Output Voltage, -40°C to +125°C Temp. Range, 5-Lead SOT23, 3,000/Reel				
b) MIC5271-3.0YM5-TR: μCap Negative Low Dropout Regulator, -3.0V Output Voltage, -40°C to +125°C Temp. Range, 5-Lead SOT23, 3,000/Reel				
c) MIC5271-5.0YM5-TR: μCap Negative Low Dropout Regulator, -5.0V Output Voltage, -40°C to +125°C Temp. Range, 5-Lead SOT23, 3,000/Reel				
Note 1: Tape and Reel identifier only appears in the catalog part number description. This identifier is used for ordering purposes and is not printed on the device package. Check with your Microchip Sales Office for package availability with the Tape and Reel option.				

MIC5271

NOTES:

Note the following details of the code protection feature on Microchip devices:

- Microchip products meet the specification contained in their particular Microchip Data Sheet.
- Microchip believes that its family of products is one of the most secure families of its kind on the market today, when used in the intended manner and under normal conditions.
- There are dishonest and possibly illegal methods used to breach the code protection feature. All of these methods, to our knowledge, require using the Microchip products in a manner outside the operating specifications contained in Microchip's Data Sheets. Most likely, the person doing so is engaged in theft of intellectual property.
- Microchip is willing to work with the customer who is concerned about the integrity of their code.
- Neither Microchip nor any other semiconductor manufacturer can guarantee the security of their code. Code protection does not mean that we are guaranteeing the product as “unbreakable.”

Code protection is constantly evolving. We at Microchip are committed to continuously improving the code protection features of our products. Attempts to break Microchip's code protection feature may be a violation of the Digital Millennium Copyright Act. If such acts allow unauthorized access to your software or other copyrighted work, you may have a right to sue for relief under that Act.

Information contained in this publication regarding device applications and the like is provided only for your convenience and may be superseded by updates. It is your responsibility to ensure that your application meets with your specifications. MICROCHIP MAKES NO REPRESENTATIONS OR WARRANTIES OF ANY KIND WHETHER EXPRESS OR IMPLIED, WRITTEN OR ORAL, STATUTORY OR OTHERWISE, RELATED TO THE INFORMATION, INCLUDING BUT NOT LIMITED TO ITS CONDITION, QUALITY, PERFORMANCE, MERCHANTABILITY OR FITNESS FOR PURPOSE. Microchip disclaims all liability arising from this information and its use. Use of Microchip devices in life support and/or safety applications is entirely at the buyer's risk, and the buyer agrees to defend, indemnify and hold harmless Microchip from any and all damages, claims, suits, or expenses resulting from such use. No licenses are conveyed, implicitly or otherwise, under any Microchip intellectual property rights unless otherwise stated.

Microchip received ISO/TS-16949:2009 certification for its worldwide headquarters, design and wafer fabrication facilities in Chandler and Tempe, Arizona; Gresham, Oregon and design centers in California and India. The Company's quality system processes and procedures are for its PIC® MCUs and dsPIC® DSCs, KEELoQ® code hopping devices, Serial EEPROMs, microperipherals, nonvolatile memory and analog products. In addition, Microchip's quality system for the design and manufacture of development systems is ISO 9001:2000 certified.

**QUALITY MANAGEMENT SYSTEM
CERTIFIED BY DNV
= ISO/TS 16949 =**

Trademarks

The Microchip name and logo, the Microchip logo, AnyRate, AVR, AVR logo, AVR Freaks, BeaconThings, BitCloud, CryptoMemory, CryptoRF, dsPIC, FlashFlex, flexPWR, Helder, JukeBlox, KEELoQ, KEELoQ logo, Klear, LANCheck, LINK MD, maXStylus, maXTouch, MediaLB, megaAVR, MOST, MOST logo, MPLAB, OptoLyzer, PIC, picoPower, PICSTART, PIC32 logo, Prochip Designer, QTouch, RightTouch, SAM-BA, SpyNIC, SST, SST Logo, SuperFlash, tinyAVR, UNI/O, and XMEGA are registered trademarks of Microchip Technology Incorporated in the U.S.A. and other countries.

ClockWorks, The Embedded Control Solutions Company, EtherSynch, Hyper Speed Control, HyperLight Load, IntelliMOS, mTouch, Precision Edge, and Quiet-Wire are registered trademarks of Microchip Technology Incorporated in the U.S.A.

Adjacent Key Suppression, AKS, Analog-for-the-Digital Age, Any Capacitor, AnyIn, AnyOut, BodyCom, chipKIT, chipKIT logo, CodeGuard, CryptoAuthentication, CryptoCompanion, CryptoController, dsPICDEM, dsPICDEM.net, Dynamic Average Matching, DAM, ECAN, EtherGREEN, In-Circuit Serial Programming, ICSP, Inter-Chip Connectivity, JitterBlocker, KlearNet, KlearNet logo, Mindi, MiWi, motorBench, MPASM, MPF, MPLAB Certified logo, MPLIB, MPLINK, MultiTRAK, NetDetach, Omniscient Code Generation, PICDEM, PICDEM.net, PICKit, PICtail, PureSilicon, QMatrix, RightTouch logo, REAL ICE, Ripple Blocker, SAM-ICE, Serial Quad I/O, SMART-I.S., SQI, SuperSwitcher, SuperSwitcher II, Total Endurance, TSHARC, USBCheck, VariSense, ViewSpan, WiperLock, Wireless DNA, and ZENA are trademarks of Microchip Technology Incorporated in the U.S.A. and other countries.

SQTP is a service mark of Microchip Technology Incorporated in the U.S.A.

Silicon Storage Technology is a registered trademark of Microchip Technology Inc. in other countries.

GestIC is a registered trademark of Microchip Technology Germany II GmbH & Co. KG, a subsidiary of Microchip Technology Inc., in other countries.

All other trademarks mentioned herein are property of their respective companies.

© 2017, Microchip Technology Incorporated, All Rights Reserved.
ISBN: 978-1-5224-2309-6



MICROCHIP

Worldwide Sales and Service

AMERICAS

Corporate Office
2355 West Chandler Blvd.
Chandler, AZ 85224-6199
Tel: 480-792-7200
Fax: 480-792-7277
Technical Support:
<http://www.microchip.com/support>
Web Address:
www.microchip.com

Atlanta

Duluth, GA
Tel: 678-957-9614
Fax: 678-957-1455

Austin, TX

Tel: 512-257-3370

Boston

Westborough, MA
Tel: 774-760-0087
Fax: 774-760-0088

Chicago

Itasca, IL
Tel: 630-285-0071
Fax: 630-285-0075

Dallas

Addison, TX
Tel: 972-818-7423
Fax: 972-818-2924

Detroit

Novi, MI
Tel: 248-848-4000

Houston, TX

Tel: 281-894-5983

Indianapolis

Noblesville, IN
Tel: 317-773-8323
Fax: 317-773-5453
Tel: 317-536-2380

Los Angeles

Mission Viejo, CA
Tel: 949-462-9523
Fax: 949-462-9608
Tel: 951-273-7800

Raleigh, NC

Tel: 919-844-7510

New York, NY

Tel: 631-435-6000

San Jose, CA

Tel: 408-735-9110
Tel: 408-436-4270

Canada - Toronto

Tel: 905-695-1980
Fax: 905-695-2078

ASIA/PACIFIC

Australia - Sydney
Tel: 61-2-9868-6733

China - Beijing
Tel: 86-10-8569-7000

China - Chengdu
Tel: 86-28-8665-5511

China - Chongqing
Tel: 86-23-8980-9588

China - Dongguan
Tel: 86-769-8702-9880

China - Guangzhou
Tel: 86-20-8755-8029

China - Hangzhou
Tel: 86-571-8792-8115

China - Hong Kong SAR
Tel: 852-2943-5100

China - Nanjing
Tel: 86-25-8473-2460

China - Qingdao
Tel: 86-532-8502-7355

China - Shanghai
Tel: 86-21-3326-8000

China - Shenyang
Tel: 86-24-2334-2829

China - Shenzhen
Tel: 86-755-8864-2200

China - Suzhou
Tel: 86-186-6233-1526

China - Wuhan
Tel: 86-27-5980-5300

China - Xian
Tel: 86-29-8833-7252

China - Xiamen
Tel: 86-592-2388138

China - Zhuhai
Tel: 86-756-3210040

ASIA/PACIFIC

India - Bangalore
Tel: 91-80-3090-4444

India - New Delhi
Tel: 91-11-4160-8631

India - Pune
Tel: 91-20-4121-0141

Japan - Osaka
Tel: 81-6-6152-7160

Japan - Tokyo
Tel: 81-3-6880-3770

Korea - Daegu
Tel: 82-53-744-4301

Korea - Seoul
Tel: 82-2-554-7200

Malaysia - Kuala Lumpur
Tel: 60-3-7651-7906

Malaysia - Penang
Tel: 60-4-227-8870

Philippines - Manila
Tel: 63-2-634-9065

Singapore
Tel: 65-6334-8870

Taiwan - Hsin Chu
Tel: 886-3-577-8366

Taiwan - Kaohsiung
Tel: 886-7-213-7830

Taiwan - Taipei
Tel: 886-2-2508-8600

Thailand - Bangkok
Tel: 66-2-694-1351

Vietnam - Ho Chi Minh
Tel: 84-28-5448-2100

EUROPE

Austria - Wels
Tel: 43-7242-2244-39
Fax: 43-7242-2244-393

Denmark - Copenhagen
Tel: 45-4450-2828
Fax: 45-4485-2829

Finland - Espoo
Tel: 358-9-4520-820

France - Paris
Tel: 33-1-69-53-63-20
Fax: 33-1-69-30-90-79

Germany - Garching
Tel: 49-8931-9700

Germany - Haan
Tel: 49-2129-3766400

Germany - Heilbronn
Tel: 49-7131-67-3636

Germany - Karlsruhe
Tel: 49-721-625370

Germany - Munich
Tel: 49-89-627-144-0
Fax: 49-89-627-144-44

Germany - Rosenheim
Tel: 49-8031-354-560

Israel - Ra'anana
Tel: 972-9-744-7705

Italy - Milan
Tel: 39-0331-742611
Fax: 39-0331-466781

Italy - Padova
Tel: 39-049-7625286

Netherlands - Drunen
Tel: 31-416-690399
Fax: 31-416-690340

Norway - Trondheim
Tel: 47-7289-7561

Poland - Warsaw
Tel: 48-22-3325737

Romania - Bucharest
Tel: 40-21-407-87-50

Spain - Madrid
Tel: 34-91-708-08-90
Fax: 34-91-708-08-91

Sweden - Gothenberg
Tel: 46-31-704-60-40

Sweden - Stockholm
Tel: 46-8-5090-4654

UK - Wokingham
Tel: 44-118-921-5800
Fax: 44-118-921-5820

Looking for pricing, stock, or lifecycle information?

Click below to explore more details on WIN SOURCE:

- ⊖ [View MIC5271YM5-TR on WIN SOURCE](#)
- ⊖ [Microchip Technology Information](#)

Optimize Your Supply Chain with WIN SOURCE Solutions

- ✓ Global Sourcing Solution
- ✓ Obsolete Management
- ✓ Cost Control Management
- ✓ Shortage Management
- ✓ Alternative Solution
- ✓ Excess Inventory Management