



MIC5307

300mA Micropower μ Cap Baseband LDO

General Description

The MIC5307 is a micropower, μ Cap low dropout regulator designed for optimal performance where smaller packages are required. It is capable of sourcing 300mA of output current while only drawing 20 μ A of operating current. This high performance LDO offers fast transient response and good PSRR while consuming a minimum of current.

Ideal for battery operated applications; the MIC5307 offers 1% initial accuracy, extremely low dropout voltage and is equipped with a TTL logic compatible enable pin. The MIC5307 can be put into a zero-off-mode current state, drawing no current when disabled.

The MIC5307 is a μ Cap design, operating with very small ceramic output capacitors for stability, reducing required board space and component cost.

The MIC5307 is available in fixed output voltages in the Thin SOT23-5 package and the 6-pin 2mm x 2mm Thin MLF[®] package.

Data sheets and support documentation can be found on Micrel's web site at www.micrel.com.

Features

- Input voltage range: 2.4V to 5.5V
- Ultra-low IQ: Only 20 μ A operating current
- Stable with ceramic output capacitor
- Low dropout voltage of 120mV @ 300mA
- High output accuracy
 - $\pm 1.0\%$ initial accuracy
 - $\pm 2.0\%$ over temperature
- Thermal Shutdown Protection
- Current Limit Protection

Applications

- Digital Logic Power Supply
- Stand-by power supply
- Cellular phones
- PDAs
- Portable electronics
- Notebook PCs

Typical Application

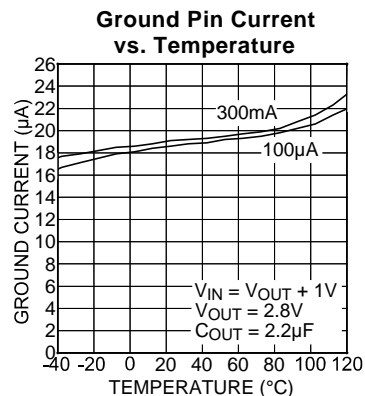
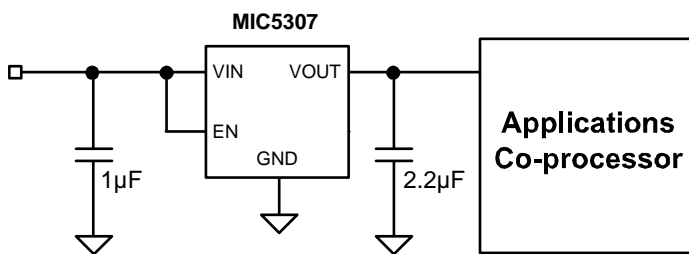

MLF and MicroLeadFrame are registered trademarks of Amkor Technology, Inc.

Micrel Inc. • 2180 Fortune Drive • San Jose, CA 95131 • USA • tel +1 (408) 944-0800 • fax + 1 (408) 474-1000 • <http://www.micrel.com>

Block Diagram

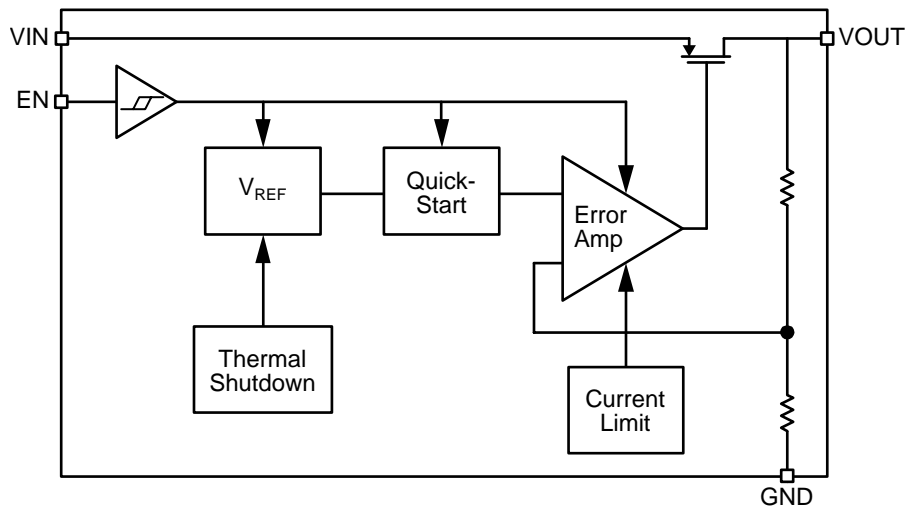

Ordering Information⁽¹⁾

Part Number	Marking Code	Voltage	Temperature Range	Package	Lead Finish
MIC5307-1.5YD5	QQ15*	1.5V	-40°C to +125°C	5-Pin TSOT23	Pb-Free
MIC5307-1.8YD5	QQ18*	1.8V	-40°C to +125°C	5-Pin TSOT23	Pb-Free
MIC5307-2.8YD5	QQ28*	2.8V	-40°C to +125°C	5-Pin TSOT23	Pb-Free
MIC5307-3.0YD5	QQ30*	3.0V	-40°C to +125°C	5-Pin TSOT23	Pb-Free
MIC5307-2.8YMT	Q28**	2.8V	-40°C to +125°C	6-Pin 2mm x 2mm Thin MLF [®]	Pb-Free

Notes

* Underbar (_) symbol may not be to scale.

** 2x2mm Thin MLF[®] is a GREEN RoHS compliant package. Lead finish is NiPdAu. Mold compound is Halogen Free.

Pin Configuration

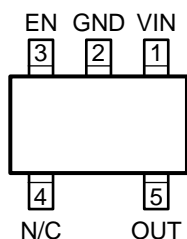

MIC5307-x.xYD5
5-Pin Thin SOT23 (D5)

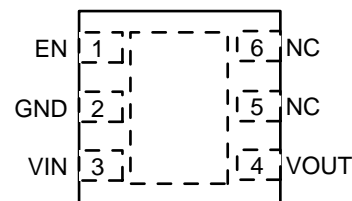

MIC5307-x.xYMT
6-Pin 2mm x 2mm Thin MLF[®] (MT)

Pin Description

Pin Number TSOT23	Pin Number Thin MLF [®]	Pin Name	Pin Function
1	3	VIN	Supply Input
2	2	GND	Ground
3	1	EN	Enable Input. Active High. High = on, low = off. Do not leave floating
4	5	NC	No Connect
5	4	VOUT	Output Voltage
-	6	NC	No Connect

Absolute Maximum Ratings⁽¹⁾

Supply Voltage (V_{IN})	0V to 6V
Enable Input Voltage (V_{EN})	0V to 6V
Power Dissipation (P_D) ⁽³⁾	Internally Limited
Junction Temperature (T_J)	-40°C to +125°C
Lead Temperature (soldering, 5sec.)	260°C
Storage Temperature (T_s)	-65°C to +150°C
ESD Rating ⁽⁴⁾	2kV

Operating Ratings⁽²⁾

Supply voltage (V_{IN})	2.4V to +5.5V
Enable Input Voltage	0V to V_{IN}
Junction Temperature (T_J)	-40°C to +125°C
Thermal Resistance	
TSOT23-5 (θ_{JA})	235°C/W
2x2 Thin MLF-6 (θ_{JA})	93°C/W

Electrical Characteristics⁽⁵⁾

$V_{IN} = V_{OUT} + 1.0V$; $C_{OUT} = 2.2\mu F$; $I_{OUT} = 100\mu A$; $T_J = 25^\circ C$, **bold** values indicate -40°C to +125°C, unless noted.

Parameter	Condition	Min	Typ	Max	Units
Output Voltage Accuracy	Variation from nominal V_{OUT}	-1		+1	%
	Variation from nominal V_{OUT} ; -40°C to +125°C	-2		+2	%
Line Regulation	$V_{IN} = V_{OUT} + 1V$ to 5.5V		0.01	0.3 0.5	%/V %/V
Load Regulation	$I_{OUT} = 100\mu A$ to 300mA		0.5	1 1.5	% %
Dropout Voltage ⁽⁴⁾	$I_{OUT} = 50mA$		20		mV
	$I_{OUT} = 100mA$		40		mV
	$I_{OUT} = 150mA$		60		mV
	$I_{OUT} = 300mA$		120	250	mV
Ground Pin Current	$I_{OUT} = 0mA$ to 150mA; $V_{IN} = 5.5V$		18		μA
	$I_{OUT} = 0mA$ to 300mA; $V_{IN} = 5.5V$		20	30	μA
Ground Pin Current in Shutdown	$V_{EN} \leq 0.2V$; $V_{IN} = 5.5V$		0.01	1	μA
Ripple Rejection	$f = 10Hz$ to 1kHz; $C_{OUT} = 2.2\mu F$; $I_{OUT} = 300mA$		62		dB
	$f = 20kHz$; $C_{OUT} = 2.2\mu F$; $I_{OUT} = 300mA$		35		dB
Current Limit	$V_{OUT} = 0V$	350	500	800	mA
Thermal Shutdown			160		°C
Thermal Shutdown Hysteresis			20		°C
Output Voltage Noise	$C_{OUT} = 2.2\mu F$; 10Hz to 100kHz		80		μV_{RMS}
Enable Input					
Enable Input Voltage	Logic Low			0.2	V
	Logic High	1.0			V
Enable Input Current	$V_{IL} \leq 0.2V$		0.01	1	μA
	$V_{IH} \geq 1.0V$		0.01	1	μA
Turn-on Time ⁽⁶⁾	$C_{OUT} = 2.2\mu F$		270	500	μs

Notes:

- Exceeding the absolute maximum rating may damage the device.
- The device is not guaranteed to function outside its operating rating.
- The maximum allowable power dissipation of any T_A (ambient temperature) is $P_{D(max)} = T_{J(max)} - T_A / \theta_{JA}$. Exceeding the maximum allowable power dissipation will result in excessive die temperature, and the regulator will go into thermal shutdown.
- Devices are ESD sensitive. Handling precautions recommended.
- Specification for packaged product only.
- Turn-on time is measured from $V_{EN} = 1V$ of the positive edge of the enable signal to 90% of the rising edge of the output voltage of the regulator.

Typical Characteristics

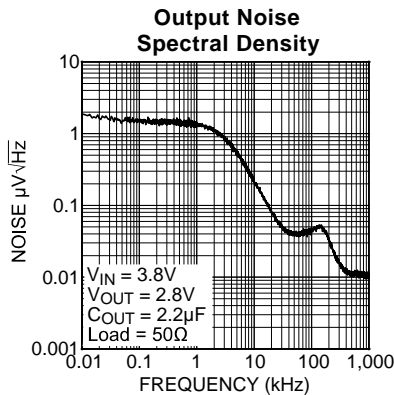
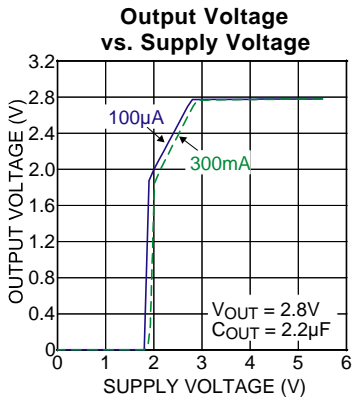
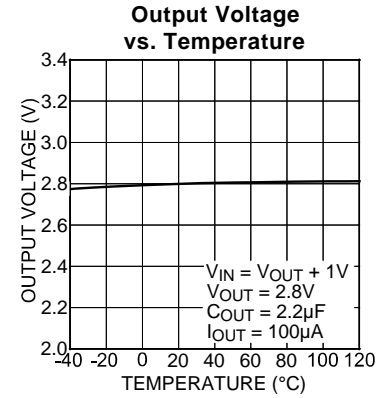
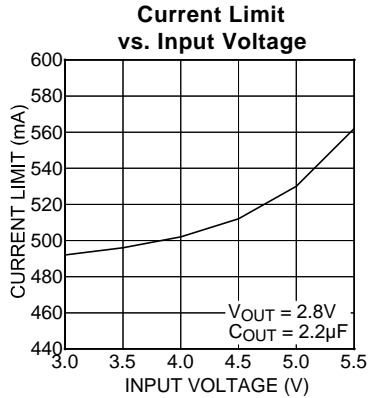
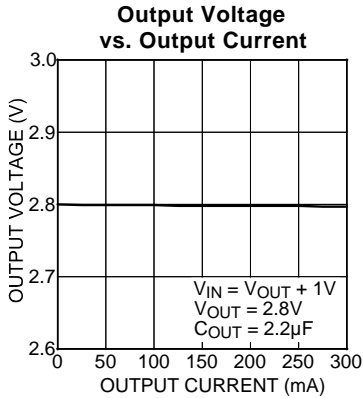
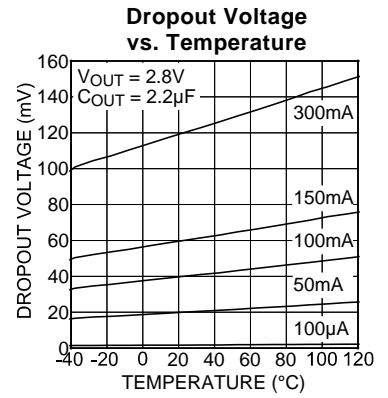
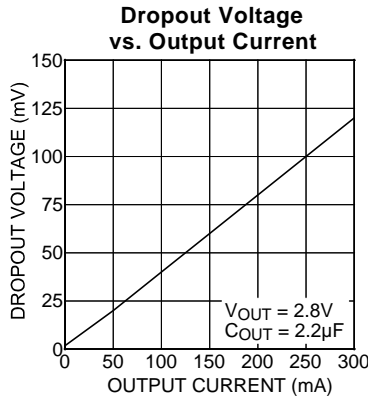
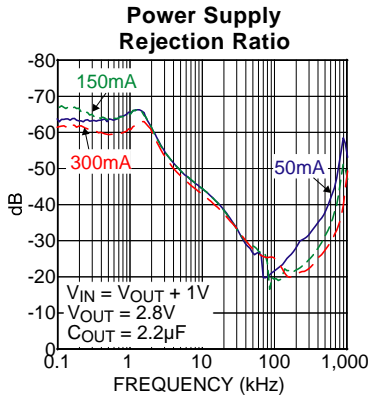
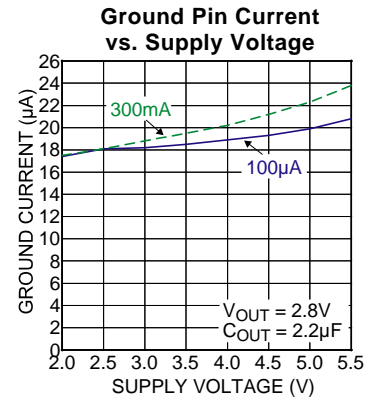
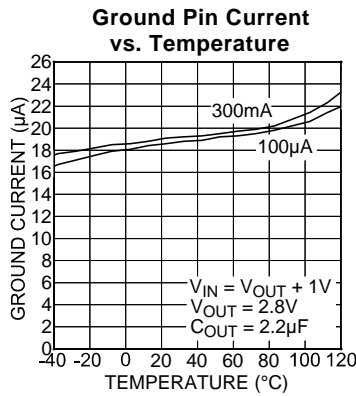
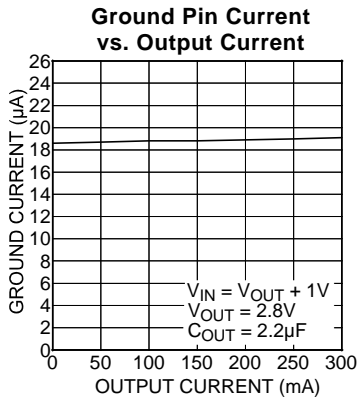

Functional Characteristics

Enable Turn-On

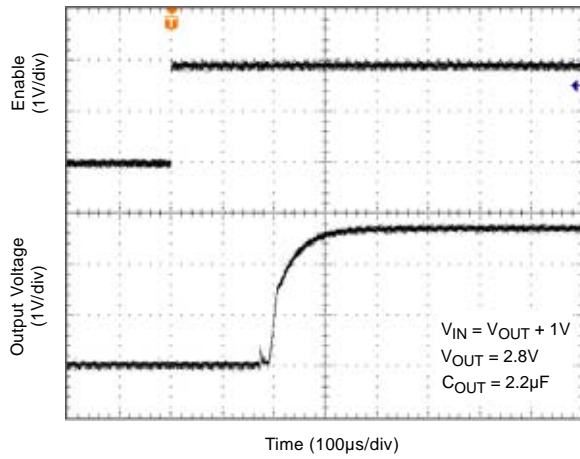

Load Transient Response

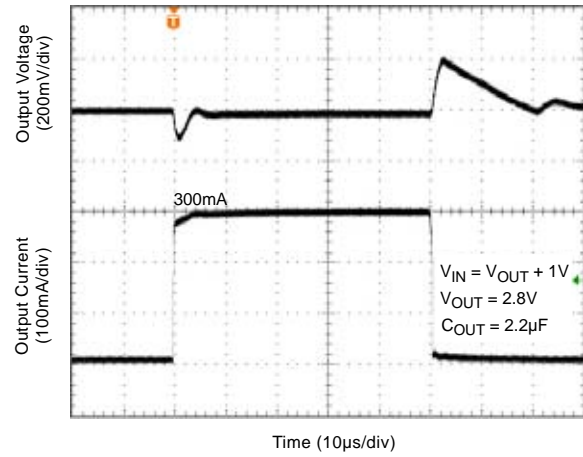

Line Transient Response

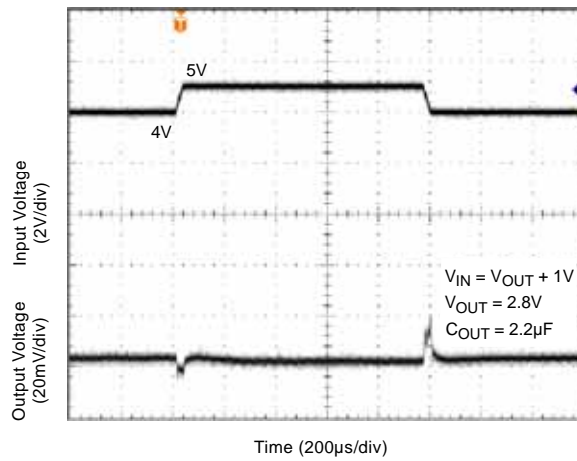

Application Information

Input Capacitance

A 1 μ F capacitor should be placed from IN to GND if there is more than 10 inches of wire between the input and the ac filter capacitor or if a battery is used as the input.

Output Capacitance

The MIC5307 requires an output capacitor of 2.2 μ F or greater to maintain stability. The design is optimized for use with low-ESR ceramic chip capacitors. High ESR capacitors may cause high frequency oscillation. The output capacitor can be increased, but performance has been optimized for a 2.2 μ F ceramic output capacitor and does not improve significantly with larger capacitance.

X7R/X5R dielectric-type ceramic capacitors are recommended because of their temperature performance. X7R-type capacitors change capacitance by 15% over their operating temperature range and are the most stable type of ceramic capacitors. Z5U and Y5V dielectric capacitors change value by as much as 50% and 60%, respectively, over their operating temperature ranges. To use a ceramic chip capacitor with Y5V dielectric, the value must be much higher than an X7R ceramic capacitor to ensure the same minimum capacitance over the equivalent operating temperature range.

Enable

Forcing EN (enable/shutdown) high (>1V) enables the regulator. EN is compatible with CMOS logic gates. If the enable/shutdown feature is not required, connect EN (pin 3) to IN (supply input, pin 1).

Current Limit

There is overcurrent protection circuitry built into the MIC5307. Even with the output grounded, current will be limited to approximately 500mA. Further protection is provided by thermal shutdown.

Thermal Considerations

The MIC5307 is designed to provide 300mA of continuous current in a very small package. Maximum ambient operating temperature can be calculated based on the output current and the voltage drop across the part. Given that the input voltage is 3.8V, the output voltage is 2.8V and the output current equals 300mA.

The actual power dissipation of the regulator circuit can be determined using the equation:

$$P_D = (V_{IN} - V_{OUT}) I_{OUT} + V_{IN} I_{GND}$$

Because this device is CMOS and the ground current is typically < 50 μ A over the load range, the power dissipation contributed by the ground current is < 1% and can be ignored for this calculation.

$$P_D = (3.8V - 2.8V) \cdot 300mA$$

$$P_D = 0.3W$$

To determine the maximum ambient operating temperature of the package, use the junction-to-ambient thermal resistance of the device and the following basic equation:

$$P_D(\max) = \frac{T_J(\max) - T_A}{\theta_{JA}}$$

$T_J(\max) = 125^\circ\text{C}$, the maximum junction temperature of the die θ_{JA} thermal resistance = 235°C/W

Table 1 shows junction-to-ambient thermal resistance for the MIC5307 in the TSOT23-5 package.

Package	θ_{JA} Recommended Minimum Footprint
TSOT23-5	235 $^\circ\text{C/W}$

Table 1. TSOT23-5 Thermal Resistance

Substituting P_D for $P_D(\max)$ and solving for the ambient operating temperature will give the maximum operating conditions for the regulator circuit. The junction-to-ambient thermal resistance for the minimum footprint is 235°C/W , from Table 1. The maximum power dissipation must not be exceeded for proper operation.

For example, when operating the MIC5307-2.8 at an input voltage of 3.8V and 300mA load with a minimum footprint layout, the maximum ambient operating temperature T_A can be determined as follows:

$$0.3W = (125^\circ\text{C} - T_A) / 235^\circ\text{C/W}$$

$$T_A = 54.5^\circ\text{C}$$

Therefore, a 2.8V application at 300mA of output current can accept an ambient operating temperature of 89.8°C in a TSOT23-5 package. For a full discussion of heat sinking and thermal effects on voltage regulators, refer to the "Regulator Thermals" section of Micrel's *Designing with Low-Dropout Voltage Regulators* handbook. This information can be found on Micrel's website at:

http://www.micrel.com/_PDF/other/LDOBK_ds.pdf

MICREL, INC. 2180 FORTUNE DRIVE SAN JOSE, CA 95131 USA
TEL +1 (408) 944-0800 FAX +1 (408) 474-1000 WEB <http://www.micrel.com>

The information furnished by Micrel in this data sheet is believed to be accurate and reliable. However, no responsibility is assumed by Micrel for its use. Micrel reserves the right to change circuitry and specifications at any time without notification to the customer.

Micrel Products are not designed or authorized for use as components in life support appliances, devices or systems where malfunction of a product can reasonably be expected to result in personal injury. Life support devices or systems are devices or systems that (a) are intended for surgical implant into the body or (b) support or sustain life, and whose failure to perform can be reasonably expected to result in a significant injury to the user. A Purchaser's use or sale of Micrel Products for use in life support appliances, devices or systems is a Purchaser's own risk and Purchaser agrees to fully indemnify Micrel for any damages resulting from such use or sale.

© 2006 Micrel, Incorporated.

Looking for pricing, stock, or lifecycle information?

Click below to explore more details on WIN SOURCE:

- ⊖ [View MIC5307-1.8YD5-TR on WIN SOURCE](#)
- ⊖ [Microchip Technology](#) Information

Optimize Your Supply Chain with WIN SOURCE Solutions

- ✓ Global Sourcing Solution
- ✓ Obsolete Management
- ✓ Cost Control Management
- ✓ Shortage Management
- ✓ Alternative Solution
- ✓ Excess Inventory Management