



**THE DATASHEET OF
MKL36Z256VLH4**





Embedded Solutions

Based on ARM Technology

Kinetis MCUs

MAC5xxx MCUs

i.MX applications processors

QorIQ communications processors

Vybrid controller solutions



freescale.com/ARM

ARM



Table of Contents

ARM Solutions Portfolio	2	i.MX Applications Processors	18
Freescale Embedded Solutions Chart	4	i.MX 6 series applications processors	20
Kinetis MCUs	6	i.MX53 applications processors	22
Kinetis K series MCUs	7	i.MX28 applications processors	23
Kinetis L series MCUs	9	i.MX and QorIQ Processor Comparison	24
Kinetis E series MCUs	11	QorIQ Communications Processors	25
Kinetis V series MCUs	12	QorIQ LS1 family	26
Kinetis M series MCUs	13	QorIQ LS2 family	29
Kinetis W series MCUs	14	Vybrid Controller Solutions	31
Kinetis EA series MCUs	15	Vybrid VF3xx family	33
MAC5xxx MCUs	16	Vybrid VF5xx family	34
MAC57D5xx MCUs	17	Vybrid VF6xx family	35
		Design Resources	36
		Freescale Enablement Solutions	37
		Freescale Connect Partner Enablement Solutions	51





Scalable. Innovative. Leading.

Your Number One Choice for ARM Solutions

Freescale is the leader in embedded control, offering the market's broadest and best-enabled portfolio of solutions based on ARM® technology. Our end-to-end portfolio of high-performance, power-efficient MCUs and digital networking processors help realize the potential of the Internet of Things, reflecting our unique ability to deliver scalable, systems-focused processing and connectivity.

Our large ARM-powered portfolio includes scalable MCU and MPU families from small ultra-low-power Kinetis MCUs to i.MX applications processors and Vybrid controller solutions with advanced performance and feature integration and QorIQ communications processors that deliver industry-leading power and performance. Each family has been designed to offer a broad range of performance, peripheral and packaging options, providing migration paths for end-product platform development. All families are supported by industry-leading

enablement (software and tool) bundles from Freescale and the extensive ARM ecosystem. Combined, our Kinetis, i.MX, QorIQ and Vybrid solutions offer the highest level of integration, the most comprehensive software and hardware enablement, and the broadest range of performance available within the ARM community. Whether you are a consumer, industrial, automotive or networking product designer, our ARM-based product families offer a solution that meets your requirements.





Kinetis MCUs

Hardware- and software-compatible MCU families based on ARM Cortex-M0+ and Cortex-M4 cores with exceptional low-power performance, scalability and feature integration.



MAC5xxx MCUs

MAC5xxx automotive MCUs integrate ARM Cortex-A and Cortex-M cores that deliver the right balance of real-time processing and application performance.



i.MX Applications Processors

Ultra-versatile solutions for multimedia and display applications with multi-core scalability and market-leading power, performance and integration.

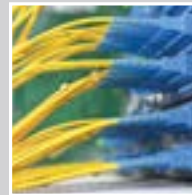

QorIQ Communications Processors

Next-generation QorIQ processors are based on Layerscape Architecture—the industry's first software-aware, core-agnostic architecture that delivers unprecedented efficiency and scale for the smarter, more capable networks of tomorrow—end to end.



Vybrid Controller Solutions

Real-time, highly integrated solutions with dual-display capability to enable your system to control, interface, connect, secure and scale.

Freescale Embedded Solutions Based on ARM Technology

QorIQ Communications Processors Built on Layerscape Architecture

ARM Cortex-A57	Up to Eight Cores, 64-bit, Clusters of Two Cores Sharing 1 MB L2 Cache, Two 64-bit DDR4 SDRAM with ECC and Interleaving Support up to 2.1 GT/s, Accelerated I/O Processing, up to 40 Gb/s Complex Forwarding, 20 Gb/s SEC Crypto Acceleration	QorIQ LS2045/85A Up to 2 GHz
ARM Cortex-A7	Two Cores, ECC-Protected L1 and L2, DDR3L/4 with ECC, Virtualization, 3 Gigabit Ethernet, 2 PCIe 2.0, 4-Lane SerDes, Security Engine, USB 2.0/3.0 with Integrated PHYs, Plus Second USB 2.0, Ten UARTs, SATA 3.0, 24-bit LCD Controller	QorIQ LS1020/21/22A Up to 1 GHz
ARM Cortex-A9	Two Cores, NEON DSP and FPU, Up to 6,000 DMIPS, 3 Gigabit Ethernet, SATA, USB 3.0 DDR3 and NAND Controller Interfaces, Deep Packet Inspection Engine	QorIQ LS1024A Up to 1.2 GHz
ARM11™	Two Cores, Packet and QoS Coprocessors for Layer 2/3/4 Acceleration, Ethernet, PCIe, TDM, USB 2.0 Interfaces	QorIQ LS102MA Up to 650 MHz

i.MX Applications Processors

ARM Cortex-A9	Four Cores, Video Encode/Decode, 2D/3D Graphics, LCDx4, HDMI, MIPI, LP-DDR2/DDR3, LVDS, IEEE® 1588 Ethernet, PCIe, SATA	i.MX 6Quad Up to 1.2 GHz
	Two Cores, Video Encode/Decode, 2D/3D Graphics, LCDx4, HDMI, MIPI, LP-DDR2/DDR3, LVDS, IEEE 1588 Ethernet, PCIe, SATA	i.MX 6Dual Up to 1.2 GHz
	Two Cores, Video Encode/Decode, 2D/3D Graphics, LCDx2, HDMI, MIPI, LP-DDR2/DDR3, LVDS, IEEE 1588 Ethernet, PCIe, E-Ink EPDC	i.MX 6DualLite Up to 1 GHz
	One Core, Video Encode/Decode, 2D/3D Graphics, LCDx2, HDMI, MIPI, LP-DDR2/DDR3, LVDS, IEEE 1588 Ethernet, PCIe, E-Ink EPDC	i.MX 6Solo Up to 1 GHz
	One Core, 2D Graphics, LCDx2, LP-DDR2/DDR3, IEEE 1588 Ethernet, E-Ink EPDC	i.MX 6SoloLite 1 GHz
Note: Secure boot, PMU, audio, dual USB w/HS PHY and LCD available on all Cortex-A9-based i.MX applications processors		
ARM Cortex-A8	One Core, Video Encode/Decode, 2D/3D Graphics, DDR3, IEEE 1588 Ethernet, SATA, CAN	i.MX53 Up to 1 GHz
	One Core, 2D Graphics, DDR2, Ethernet, E Ink EPD	i.MX50 800 MHz
ARM11	One Core, 2D Graphics, DDR2, Ethernet, CAN	i.MX35 532 MHz
ARM9™	One Core, DDR2, IEEE 1588 Dual Ethernet, CAN, L2 Switch, PMU	i.MX28 454 MHz
	One Core, DDR2/SDRAM, Ethernet, CAN, PATA, Camera, Tamper Detect	i.MX25 400 MHz
	One Core, PMU, Analog Audio	i.MX233 450 MHz

Vybrid Controller Solutions

ARM Cortex-A5 and Cortex-M4	VF6xx ARM Cortex-A5 (500 MHz) + Cortex-M4 (167 MHz)	Dual SVGA LCD, Camera Interface with Video ADC, Stereo Audio, DDR, Secure Boot, Tamper Detect, Dual USB OTG w/HS PHY, Dual Ethernet, L2 Switch, Dual Quad-SPI, NAND Flash Controller
ARM Cortex-A5	VF5xx Up to 500 MHz	SVGA LCD, Camera Interface, Stereo Audio, DDR, Secure Boot, Tamper Detect, Dual USB OTG w/HS PHY, Dual Ethernet, L2 Switch, Dual Quad-SPI, NAND Flash
	VF3xx Up to 266 MHz	WQVGA LCD, Audio, Secure Boot, Tamper Detect, USB OTG w/HS PHY, Dual Ethernet, L2 Switch, Dual Quad-SPI, NAND Flash Controller, 176LQFP
ARM Cortex-A5 and Cortex-M4	VF5xxR Up to 400 MHz	Dual Heterogeneous Cores, DDR3 Interface, 400 MHz, WVGA LCD x 2 or XGA, USB x 2, Dual Quad SPI, MLB 50, CAN x 2
	VF3xxR Up to 266 MHz	Dual Heterogeneous Cores, 266 MHz, WQVGA LCD x 2, USB, Dual Quad SPI, MLB 50, CAN x 2
	VF1xxR Up to 266 MHz	Dual Heterogeneous Cores, 266 MHz, WQVGA LCD, USB, Dual Quad SPI, CAN x 2

Kinetis MCUs

ARM Cortex-M4

	Kinetis KV4x 150 MHz		4.1 Msps ADC, Picosecond PWM, CAN, Digital Power Conversion and Motor Control
	Kinetis K7x 120–150 MHz		Graphics LCD, IEEE 1588 Ethernet, Encryption, Tamper Detect, USB OTG (FS/HS), FPU, DRAM Controller, 512 KB–1 MB Flash
	Kinetis K6x 100–180 MHz		IEEE 1588 Ethernet, Encryption, Tamper Detect, USB OTG (FS/HS), FPU, DRAM Controller, 256 KB–2 MB Flash
	Kinetis K0x 100 MHz		Entry Level, FPU, up to 64–128 KB Flash
	Kinetis KV3x 100–120 MHz		PMSM Motor Control, Multiple Timers, FPU, 64–512 KB Flash
	Kinetis K5x 72–100 MHz		Analog Measurement Engine, IEEE 1588 Ethernet, Encryption, USB OTG (FS), Segment LCD, 128–512 KB Flash
	Kinetis K4x 72–100 MHz		USB OTG (FS), Segment LCD, 64–512 KB Flash
	Kinetis K3x 72–100 MHz		Segment LCD, 64–512 KB Flash
	Kinetis K2x 50–120 MHz		USB OTG (FS/HS), FPU, 32 KB–1 MB Flash
	Kinetis K1x 50–120 MHz		Mixed Signal, FPU, 32 KB–1 MB Flash
	Kinetis KW2x 50 MHz		2.4 GHz IEEE 802.15.4 Compliant Radio Transceiver, 256–512 KB Flash

ARM Cortex-M0+

	Kinetis KV1x 75 MHz		BLDC Motor Control, 1.2 Msps ADC, 16–32 KB Flash
	Kinetis KM3x 50 MHz		Segment LCD, Serial Wire Debug, MCG, BME, CRC, Vref, 64–128 KB Flash
	Kinetis KM1x 50 MHz		Serial Wire Debug, MCG, BME, CRC, Vref, 64–128 KB Flash
	Kinetis KW0x 48 MHz		Sub-1 GHz Radio Transceiver, 128 KB Flash
	Kinetis KL4x 48 MHz		USB OTG, Segment LCD, DMA, 16-bit ADC, 12-bit DAC, 128–256 KB Flash
	Kinetis KL3x 48 MHz		Segment LCD, DMA, 12/16-bit ADC, 12-bit DAC, 64–256 KB Flash
	Kinetis KL2x 48 MHz		USB OTG, DMA, 12/16-bit ADC, 12-bit DAC, 4–32 KB Flash
	Kinetis KL1x 48 MHz		DMA, 16-bit ADC, 12-bit DAC, 32–256 KB Flash
	Kinetis KL0x 48 MHz		DMA, 12-bit ADC, 12-bit DAC, 8–32 KB Flash
	Kinetis KEA 48 MHz		32-bit Automotive MCUs, Voltage range: 2.7 to 5.5 V, Flash write voltage range: 2.7 to 5.5 V, Temperature range (ambient): –40 °C to +125 °C
	Kinetis KE0x 20–48 MHz		5 V, ESD/EMC, ADC, Robust Timers, High Current Outputs, 8–128 KB Flash

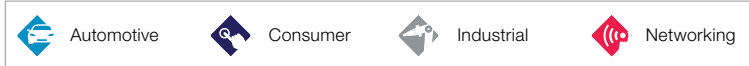



Kinetis Microcontrollers

Scalable, ultra-low-power, mixed-signal MCUs

The Kinetis portfolio consists of multiple hardware- and software- compatible MCUs based on ARM Cortex-M0+ and Cortex-M4 cores with the choice of general purpose or application-specific features. Each Kinetis series combines excellent low-power performance with feature, memory and package scalability. All Kinetis MCUs are supported by a comprehensive Freescale and third-party hardware and software enablement system that reduces development costs and time to market.

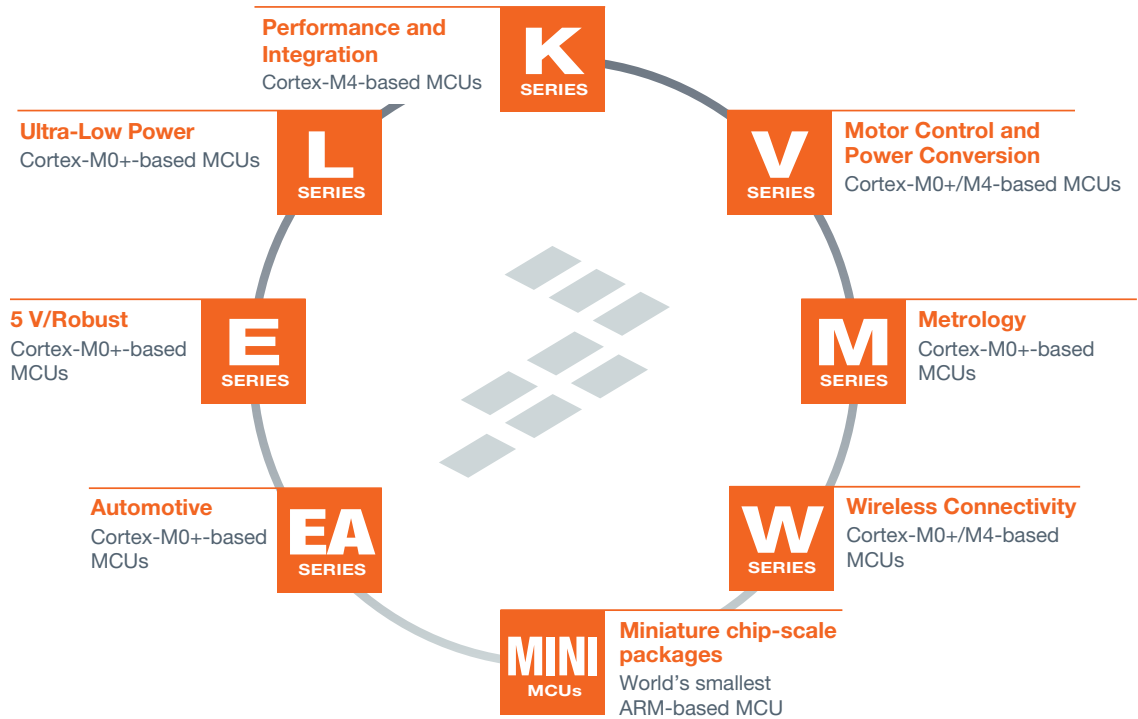

Kinetis K Series MCUs

Built on the ARM Cortex-M4 Core

Performance and Integration

Kinetis K Series MCUs

The 32-bit Kinetis K series MCUs are based on the high performance ARM Cortex-M4 core. The K series includes hundreds of products, spanning from 32 KB of flash up to 2 MB, along with a broad range of peripheral combinations for measurement and control, connectivity and security. Design teams looking for an MCU to provide the right ratio of price, performance and features are sure to find what they're looking for within this broad family.

K2: The Next Generation of Kinetis Solutions

The next generation of Kinetis solutions builds on the portfolio's strong history of scalability and innovation paired with an even more expansive enablement toolset.

K2—the next generation of Kinetis solutions brings you a comprehensive set of software and development tools with next-generation devices offering optimized performance and power efficiency with industry-leading low dynamic power consumption and best-in-class flexible low-power modes.

To learn more, visit

freescale.com/Kinetis/Kseries.

Kinetis K Series MCUs

Memory	<ul style="list-style-type: none"> • Up to 2 MB of flash memory • Up to 256 KB SRAM • Single cycle access to flash • Optional EEPROM • MPU and flash swap controller to enable robust firmware updates • CRC module • DRAM and NAND flash I/F
Power Efficiency	<ul style="list-style-type: none"> • Cortex-M4 core with FPU, MAC and SIMD • 1.71–3.6 V voltage supply with full access to analog and memory across full range • Powerful DMA and X-bar switch enabling parallel processing • Less than 150 μA/MHz in run modes, fast wake-up times, lowest power mode down to 150 nA and 10 modes of operation to balance performance and power
Rich Mixed Signal	<ul style="list-style-type: none"> • Up to 4x configurable 16-bit ADCs supporting on-chip PGAs • High-speed analog comparators with integrated 6-bit DAC • Up to 2x 12-bit DAC • FlexTimers for ICAP, OCOMP and PWM
Connectivity	<ul style="list-style-type: none"> • 10/100 BaseT Ethernet MAC with stacks supporting IPv6 • Multiple USB options, including full- and high-speed USB 2.0 On-the-Go, device charge detect capability, and crystal-less USB functionality • Up to 2x FlexCAN, 2.0B compliant • Up to 6 UART, support available for smart card plus Manchester encoding • Up to 3 SPI with chip selects • Up to 2 I²S or serial audio I/F • Up to 3 I²C with support for up to 1 Mbit/s operation • SDIO I/F
Security	<ul style="list-style-type: none"> • Hardware encryption accelerator • Random number generator • Anti-tamper circuitry to monitor and help prevent application tampering and protect your IP
HMI	<ul style="list-style-type: none"> • Graphics controller supporting SVGA resolution • Parallel bus for camera I/F • Capacitive touch-sensing module

Kinetis K Series MCUs

Common Features

System
ARM Cortex-M4 Core
Multiple Low-Power Operation Modes, Clock Gating, 1.71–3.6 V, 5 V Tolerant I/O
DMA, Memory Protection Unit, Crossbar Switch
Operating Temp: –40 °C to +105 °C
Memory
90 nm TFS Flash Memory (High Reliability, Fast Access)
FlexMemory (EEPROM)
SRAM
Internal Memory Security/Protection
Analog Peripherals
16-bit ADC
Programmable Gain Amplifiers
12-bit DAC
High-Speed Comparators
Low-Power Touch-Sensing Interface
Serial Interfaces
UART, SPI, I ² C
SAI (I ² S)
Timers
RTC
Motor Control Timers
Low-Power Timers
Programmable Delay Block
System Timers
Other Peripherals
CRC
eSDHC
External Bus Interface

Feature Options

CPU		Internal Memory		Communication			HMI	Security		Memory/Expansion		Analog
K7x Family: Graphics LCD MCUs												
120 to 150 MHz	Floating-Point Unit	512 KB to 1 MB Flash	128 KB SRAM	USB OTG (FS and HS)	CAN	Ethernet (IEEE® 1588)	Graphics LCD	Hardware Encryption	Tamper Detection	NAND Flash Controller	DRAM Controller	–
K6x Family: Ethernet MCUs												
100 to 180 MHz	Floating-Point Unit	256 KB to 2 MB Flash	64 KB to 256 KB SRAM	USB OTG (FS and HS)	CAN	Ethernet (IEEE 1588)	–	Hardware Encryption	Tamper Detection	NAND Flash Controller	DRAM Controller	–
K5x Family: Measurement MCUs												
72 to 100 MHz	–	128 KB to 512 KB Flash	32 KB to 128 KB SRAM	USB OTG (FS)	–	Ethernet (IEEE 1588)	Segment LCD	Hardware Encryption	–	–	–	Measurement Engine
K4x Family: USB & Segment LCD MCUs												
72 to 100 MHz	–	64 KB to 512 KB Flash	16 KB to 128 KB SRAM	USB OTG (FS)	CAN	–	Segment LCD	–	–	–	–	–
K3x Family: Segment LCD MCUs												
72 to 100 MHz	–	64 KB to 512 KB Flash	16 KB to 128 KB SRAM	–	CAN	–	Segment LCD	–	–	–	–	–
K2x Family: USB MCUs												
50 to 120 MHz	Floating-Point Unit	32 KB to 1 MB Flash	8 KB to 256 KB SRAM	USB OTG (FS and HS)	CAN	–	–	Hardware Encryption	Tamper Detection	NAND Flash Controller	–	–
K1x Family: Baseline MCUs												
50 to 120 MHz	Floating-Point Unit	32 KB to 1 MB Flash	8 KB to 128 KB SRAM	–	CAN	–	–	Hardware Encryption	Tamper Detection	NAND Flash Controller	–	–
K0x Family: Entry-Level MCUs												
100 MHz	Floating-Point Unit	64 KB to 128 KB Flash	16 KB SRAM	–	–	–	–	–	–	–	–	–

Note: Not all features are available on all product variants.

Freescal Development Tools for the Kinetis K Series MCUs

Development Tool Part Number	Kinetis MCU Family Support	Extended Hardware Support Options
FRDM-K20D50M ^[1]	50 MHz MK10 and MK20	Arduino™ footprint-compatible with support for a rich set of third-party expansion boards (“shields”)
FRDM-K22F ^[1,2]	100/120 MHz MK22	
FRDM-K64F ^[1,2]	120 MHz MK24, MK63, MK64	
TWR-K20D50M	50 MHz MK10 and MK20	
TWR-K20D72M	72 MHz MK10 and MK20	
TWR-K21D50M	50 MHz MK11, MK12, MK21 and MK22	
TWR-K21F120M	120 MHz MK21 and MK22	
TWR-K22F120M ^[2]	100/120 MHz MK22	
TWR-K24F120M ^[2]	120 MHz MK24	
TWR-K40D100M	100 MHz MK30 and MK40	
TWR-K53N512	MK50, MK51, MK52 and MK53	
TWR-K60D100M	100 MHz MK10, MK20 and MK60	
TWR-K60F120M	120/150 MHz MK10, MK20 and MK60	
TWR-K64F120M ^[2]	120 MHz MK24, MK63, MK64	
TWR-K70F120M	120/150 MHz MK61 and MK70	

[1] ARM mbed™ enabled [2] Kinetis SDK enabled

Bundled kits with peripheral modules are available. For more information, visit freescal.com/Tower and freescal.com/Freedom.

Kinetis L Series MCUs

Built on the ARM Cortex-M0+ Core

Ultra-Low Power

Kinetis L Series MCUs

Kinetis L series MCUs, based on ARM technology, are the world's most energy efficient, bringing new design possibilities to entry-level applications that have previously been limited by 8-/16-bit MCU capabilities.

Kinetis L series MCUs combine the enhanced energy efficiency, performance and debug features of the new 32-bit ARM Cortex-M0+ core with the scalability, feature integration and enablement of the Kinetis MCU portfolio. Available with multiple flash memory options and a rich selection of analog, connectivity and HMI peripherals, Kinetis L series MCUs are also hardware and software compatible with Kinetis K series MCUs based on the ARM Cortex-M4 core.

Energy Efficiency

Kinetis L series MCUs supplement the low-power ARM Cortex-M0+ core with low-power 90 nm process technology, platform design, operating modes and energy-saving peripherals. Combined, they increase the time spent in deep sleep modes, minimizing CPU activity and extending battery life.

ARM Cortex-M0+ Core

The World's Most Energy-Efficient Processor

- Kinetis L series MCUs based on the ARM Cortex-M0+ core deliver up to 2.42 CoreMark®/MHz*: 2x–40x more than 8- and 16-bit competitors and approximately 10 percent more than the ARM Cortex-M0
- Single-cycle access to I/O: Up to 50 percent faster than standard I/O for improved reaction time to external events
- Two-stage pipeline: Reduced cycles per instruction enables faster branch instruction and ISR entry
- Excellent code density vs. 8-bit and 16-bit MCUs: Reduced flash size, system cost and power consumption

Kinetis KL03 CSP: The World's Smallest ARM Powered MCU

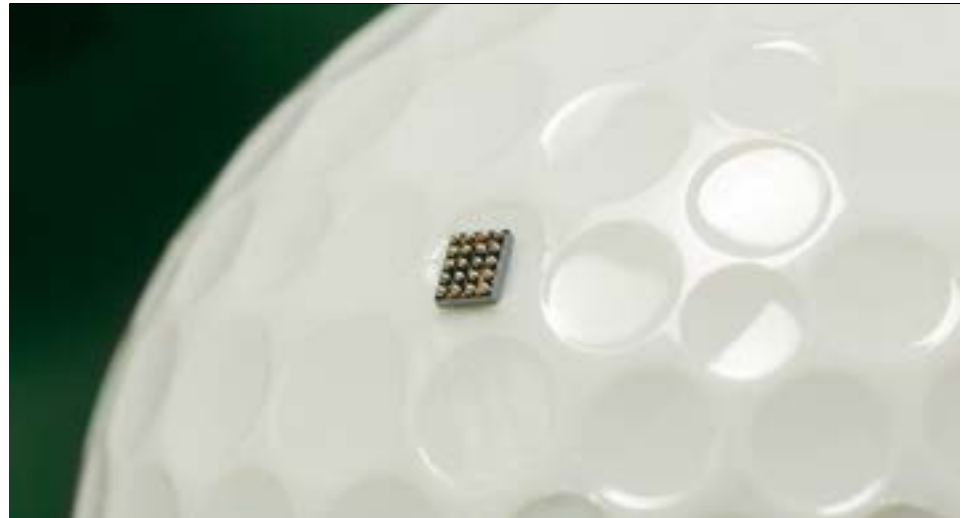

Kinetis L Series MCUs: The Evolution of the Entry-Level MCU

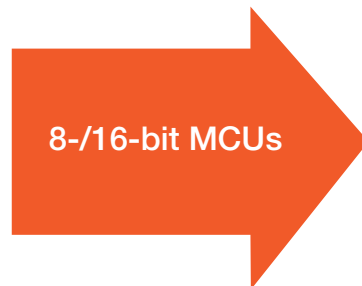

Kinetis L Series 32-bit MCUs

- **Energy Efficiency**
Class-leading CoreMark/mW
- **Scalability and Integration**
Kinetis L to K Series (ARM Cortex-M0+ to ARM Cortex-M4)
- **Enablement**
Freescale Bundle + ARM Ecosystem
- **Ultra-Low Static Current**
<1 µA
- **Low Cost**
From <\$0.50
- **Ease of Use**
Freescale Freedom Development Platform, Processor Expert and MCU Solution Advisor

- 56 instructions: Easy programming and efficient packaging of 8-/16-/32-bit data in memory. One hundred percent instruction set compatible with the ARM Cortex-M0 processor
- Linear 4 GB address space: No complex paging, simpler software
- Micro trace buffer: Lightweight trace solution for fast bug identification

To learn more visit

freescale.com/Kinetis/Lseries.

***NOTE:** CoreMark: 1.0 : IAR Compiler 6.60, --endian=little --cpu=Cortex-M0+ -e --fpu=None -Ohs --use_c++_inline --no_size_constraints, Code in internal Flash - Data in internal RAM

Kinetis Mini MCUs

Freescale is providing industry-leading developments within chip-scale package technology to enable smaller packages with greater functionality than previously seen in the market. Kinetis mini MCUs span multiple cores and different Kinetis series and include the ultra-thin, 'world's smallest ARM Powered® MCU,' the Kinetis KL03 CSP, at just 1.6 mm x 2.0 mm.

To learn more visit freescale.com/KinetisMinis.

Kinetis L Series MCUs

Common Features

Feature Options

System	Family	Flash	SRAM	Pin Count	Key Features											
					USB	SLCD	DMA	RTC	ADC	DAC	I ² S	TSI	Boot ROM	VREF	FLEXIO	
ARM Cortex-M0+ Core, 48 MHz																
Multi-Low-Power Modes and Peripherals, Low-Power Boot, Clock Gating	KL46	128–256 KB	16–32 KB	64–121	OTG	√	√	√	16-bit	12-bit	√	√				
1.71–3.6 V, –40° C to +105° C ^[1]	KL43	128–256 KB	16–32 KB	64	Slave	√	√	√	16-bit	12-bit	√		√	√	√	
Memory																
90 nm TFS Flash, SRAM	KL36	64–256 KB	8–32 KB	64–121		√	√	√	16-bit	12-bit	√	√				
Internal Memory Security/Protection	KL34	64 KB	8 KB	64–100		√	√	√	12-bit							
Analog Peripherals																
12-/16-bit ADC, 12-bit DAC	KL33	128–256 KB	16–32 KB	64		√	√	√	16-bit	12-bit	√		√	√	√	
High-Speed Comparator	KL27	128–256 KB	32 KB	32–64	Slave		√	√	16-bit	12-bit	√		√	√	√	
Serial Interfaces																
UART (including 1 LPUART)	KL26	32–256 KB	4–32 KB	32–121	OTG		√	√	16-bit	12-bit	√	√				
SPI, I ² C	KL25	32–128 KB	4–16 KB	32–80	OTG		√	√	16-bit	12-bit		√				
Timers																
Real-Time Clock ^[2]	KL24	32–64 KB	4–8 KB	32–80	OTG		√	√	12-bit							
16-bit Low-Power TPMs (GP Timer/PWM)	KL17	128–256 KB	32 KB	32–64			√	√	16-bit	12-bit	√		√	√	√	
Low-Power Timers	KL16	32–256 KB	4–32 KB	32–64			√	√	16-bit	12-bit	√	√				
32-bit Periodic Interrupt Timer	KL15	32–128 KB	4–16 KB	32–80			√	√	16-bit	12-bit		√				
	KL14	32–64 KB	4–8 KB	32–80			√	√	12-bit							
	KL05	8–32 KB	1–4 KB	24–48			√	√	12-bit	12-bit		√				
	KL04	8–32 KB	1–4 KB	24–48			√	√	12-bit							
	KL03	8–32 KB	2 KB	16–24				√	12-bit				√	√		
	KL02	8–32 KB	1–4 KB	16–32					12-bit							

[1] Feature not available on CSP packages
 [2] For KL02, use software to support

Freescal Development Tools for the Kinetis L Series MCUs

Development Tool Part Number	Kinetis MCU Family Support	Extended Hardware Support Options
FRDM-KL02Z	48 MHz KL02Z	Arduino footprint-compatible with support for a rich set of third-party expansion boards ("shields")
FRDM-KL03Z ^[2]	48 MHz KL03Z	
FRDM-KL05Z ^[1]	48 MHz KL04Z and KL05Z	
FRDM-KL25Z ^[1]	48 MHz KL14Z, KL15Z, KL24Z and KL25Z	
FRDM-KL26Z	48 MHz KL16Z and KL26Z	
FRDM-KL43Z ^[2]	48 MHz KL43, KL33, KL27 and KL17	
FRDM-KL46Z ^[1]	48 MHz KL16Z, KL26Z, KL34Z, KL36Z and KL46Z	
TWR-KL25Z48M	48 MHz KL14Z, KL15Z, KL24Z and KL25Z	Tower System peripheral modules can be added for enhanced functionality, including 802.11.x, serial connectivity, analog, sensors, graphics LCD, audio, MFi interface (iPad, iPhone, iPod), general I/O, 2.4 GHz and sub-1 GHz RF, motor control, memory, etc.
TWR-KL43Z48M ^[2]	48 MHz KL43, KL33, KL27 and KL17	
TWR-KL46Z48M	48 MHz KL16Z, KL26Z, KL34Z, KL36Z and KL46Z	

[1] ARM mbed enabled [2] Kinetis SDK enabled

Bundled kits with peripheral modules are available. For more information, visit freescale.com/Tower and freescale.com/Freedom.

Kinetis E Series MCUs

Built on the ARM Cortex-M0+ Core

5 V and Robust

Kinetis E series MCUs are designed for high-electrical noise environments and high-reliability applications that require 5 V operation and robust EMC performance. Kinetis E series MCUs include powerful analog, timing and control peripherals with a broad range of flash memory and package options. Parts within the Kinetis E series share common peripherals and packages, allowing developers to migrate easily within an MCU family or between MCU families to take advantage of more memory or feature integration. This scalability allows developers to standardize on the Kinetis E series MCUs for their end-product platforms, maximizing hardware and software reuse and reducing time to market.

Features

- 32-bit ARM Cortex-M0+ core
- Scalable memory footprints from 8 KB flash/1 KB SRAM to 128 KB flash/16 KB SRAM
- Precision mixed-signal capability with on-chip analog comparator and 12-bit ADC
- Powerful timers for a broad range of applications, including motor control
- Serial communication interfaces such as UART, SPI, I²C, etc.
- High security and safety with internal watchdog and programmable CRC module
- Single power supply (2.7–5.5 V) with full functional flash program/erase/read operations
- Ambient operation temperature range: –40 °C to +105 °C
- Robust 5 V MCU with 8-bit S08 compatibility

Overview

Kinetis KE0x MCUs are the entry point into the E series and are pin-compatible with other E devices, as well as with the 8-bit S08P family. This family includes a powerful array of analog, communication, timing and control peripherals with varying flash

Kinetis E Series MCUs

Common Features		Feature Options							
System		CPU	Flash	SRAM	Key Features				
ARM Cortex-M0+ Core Multiple Power Modes, Clock Gating 2.7–5.5 V, –40° C to +105° C					CAN	Flex Timer	PWT	Fast Timer	ADC
Clock Management		KE06							
External OSC, 4–20 MHz, 32 KHz		48 MHz	64–128 KB	8–16 KB	√	3	√	√	12-bit
Analog Peripherals		KE04							
Internal OSC, 32 KHz, 1 KHz		48 MHz	8–128 KB	1–16 KB		Up to 3	√	√	12-bit
Serial Interfaces		KE02							
12-bit ADC Analog Comparators		20 MHz/ 40 MHz	16–64 KB	2–4 KB		3			12-bit
Timers									
Real-Time Clock 16-bit Flex Timers 32-bit Periodic Interrupt Timer									

Freescale Development Tools for the Kinetis E Series MCUs

Development Tool Part Number	Kinetis MCU Family Support	Extended Hardware Support Options
FRDM-KE02Z	20 MHz KE02Z	Arduino footprint-compatible with support for a rich set of third-party expansion boards (“shields”)
FRDM-KE02Z40M	40 MHz KE02	
FRDM-KE04Z	48 MHz KE04	
FRDM-KE06Z	48 MHz KE06 and KE04	

For more information, visit freescale.com/Freedom.

memory size and pin count. Additionally, the series offers highly robust, cost-effective and energy-efficient MCUs that provide the appropriate entry-level solution. Ultimately, this product group is the next-generation MCU solution, offering enhanced ESD/EMC performance for cost-sensitive, high-reliability device applications used in high electrical noise environments.

To learn more, visit freescale.com/Kinetis/Eseries.

Kinetis V Series MCUs

Built on ARM Cortex-M0+/M4 Cores

Motor Control and Power Conversion

Kinetis V Series MCUs are based upon the ARM Cortex-M0+ and M4 cores and are designed for BLDC, PMSM and ACIM motor control, as well as digital power conversion applications. The Kinetis KV1x MCU family is the entry point and features a 75 MHz ARM Cortex-M0+ core with a hardware square root and divide block giving it a 27% increase in performance vs. comparable 32-bit MCUs in sensorless PMSM control.

With an ARM Cortex-M4 core, floating point unit and clock frequencies of up to 150 MHz, the Kinetis KV3x and Kinetis KV4x MCU families extend the V series to higher dynamic control systems including those with multiple motors. Kinetis V series MCU features include dual 16-bit analog-to-digital converters (ADCs) sampling at up to 1.2 mega samples per second (MS/s) in 12-bit mode, multiple motor control timers and 16-512 KB of flash memory. The Kinetis KV4x MCU family includes advanced analog and timing peripherals from Freescale's digital signal controller (DSC) portfolio to address the requirements of digital power conversion applications. All families are supported by a full enablement suite from Freescale and third-party resources, including reference designs, software libraries and motor configuration tools.

To learn more, visit freescale.com/Kinetis/Vseries.

Kinetis V Series MCU Family Block Diagram

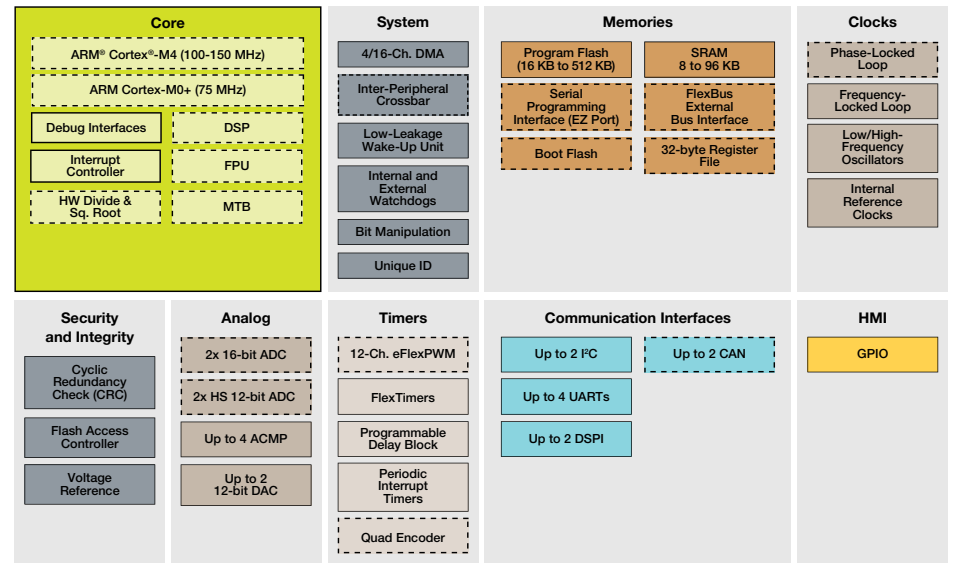

Standard Feature Optional Feature

Kinetis V Series MCU Selector Guide

Family	Core/ Frequency	Flash Range	ADC	FlexTimers/ eFlexPWM	DAC	ACMP
KV1x	Cortex-M0+ 75 MHz	16–32 KB	2x 16-bit 1.2 MSps	Up to 10-ch. FlexTimers	1x 12-bit	2x ACMP with 6-bit DAC
KV3x	Cortex-M4 100/120 MHz	64–512 KB	2x 16-bit 1.2 MSps	Up to 20-ch. FlexTimers	Up to 2x 12-bit	2x ACMP with 6-bit DAC
KV4x	Cortex-M4 150 MHz	64–256 KB	2x 12-bit 4.1 MSps/1.9 MSps	Up to 2x 8-ch. + 1x 2-ch. FlexTimers/ 12-ch eFlexPWM + Nano-Edge	1x 12-bit	4x ACMP with 6-bit DAC

Freescale Development Tools for the Kinetis V Series MCUs

Development Tool Part Number	Kinetis MCU Family Support	Extended Hardware Support Options
TWR-KV10Z32	MKV10	Tower System peripheral modules can be added for enhanced functionality, including 802.11.x, serial connectivity, analog, sensors, graphics LCD, audio, MFi interface (iPad, iPhone, iPod), general I/O, 2.4 GHz and sub-1 GHz RF, motor control, memory, etc.
TWR-KV31F120M	MKV3x	
TWR-KV46F150M	MKV4x	

Bundled Tower System kits with peripheral boards are available.

For more information, visit freescale.com/Tower.

Kinetis M Series MCUs

Built on the ARM Cortex-M0+ Core

Metrology

Kinetis M series MCUs are based on the 32-bit ARM Cortex-M0+ core and provide a low-cost, highly integrated solution for one-, two- and three-phase electricity meters that require powerful 32-bit processing capability, precision analog, security and HMI functionality.

Each MCU includes a powerful analog front end that is configurable for different regions and enables power calculations with 0.1% measurement accuracy and satisfies all ESD requirements. A high-accuracy real-time clock delivers less than 5 ppm drift over temperature. Metrology firmware for calculating active, reactive and apparent power using a variety of algorithms is provided free of charge by Freescale. Pre-certified reference designs for Europe, China, India, the U.S. and Japan are available for customer evaluation. The Kinetis M series is supported by the Tower System hardware development platform.

Features

- High-performance ultra-low-power ARM Cortex-M0+ core
- 24-bit sigma-delta ADC and PGA achieving 92 dB SNR
- High-accuracy RTC with +5 PPM overtemperature
- Rich set of security: MPU, active tamper, RNGA, CRC for WELMEC-compliant meters
- Pre-certified metrology software

To learn more, visit freescale.com/Kinetis/Mseries.

Kinetis M Series MCU Family Block Diagram

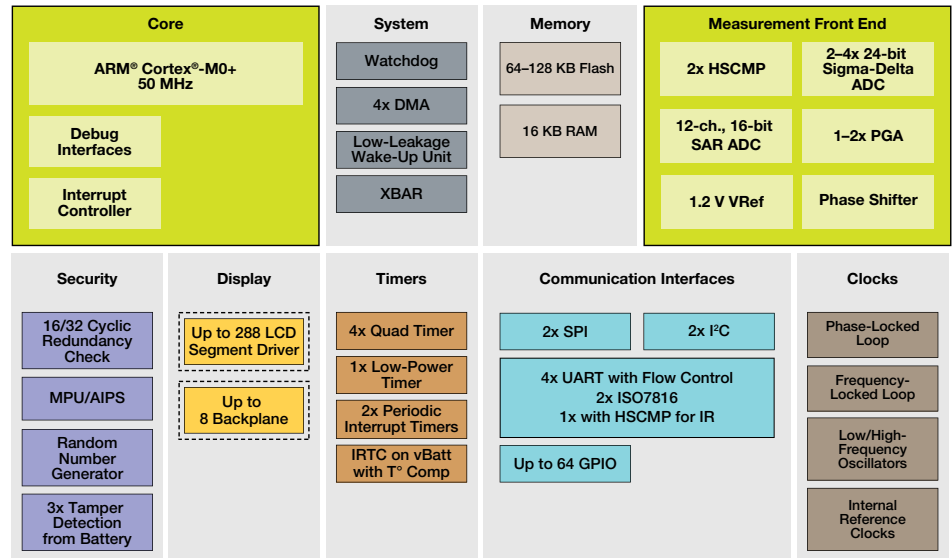

Optional

Kinetis M Series MCU Selector Guide

Part Number	Meter Type	Package	Sigma Delta ADCs	Segment LCD	Memory	
					Flash	RAM
MKM14Z64CHH5	1-/2-/3- Phase	LGA 44	4	no	64 KB	16 KB
MKM14Z128CHH5	1-/2-/3- Phase	LGA 44	4	no	128 KB	16 KB
MKM33Z64CLH5	Single Phase	LQFP 64	3	8 x 20	64 KB	16 KB
MKM33Z128CLH5	Single Phase	LQFP 64	3	8 x 20	128 KB	16 KB
MKM33Z64CLL5	Single Phase	LQFP 100	3	8 x 36	64 KB	16 KB
MKM33Z128CLL5	Single Phase	LQFP 100	3	8 x 36	128 KB	16 KB
MKM34Z128CLL5	1-/2-/3- Phase	LQFP 100	4	8 x 36	128 KB	16 KB

Freescale Development Tools for the Kinetis M Series MCUs

Development Tool Part Number	Kinetis MCU Family Support	Extended Hardware Support Options
TWR-KM34Z50M	50 MHz KM14Z, KM33Z, and KM34Z	Tower System peripheral modules can be added for enhanced functionality, including 802.11.x, serial connectivity, analog, sensors, graphics LCD, audio, MFi interface (iPad, iPhone, iPod), general I/O, 2.4 GHz and sub-1 GHz RF, motor control, memory, etc.

Bundled Tower System kits with peripheral boards are available.

For more information, visit freescale.com/Tower.

Kinetis W Series MCUs

Built on ARM Cortex-M0+/M4 Cores

Connectivity

Kinetis W series MCUs integrate class-leading sub-1 GHz and 2.4 GHz RF transceivers with ARM Cortex cores, providing robust feature sets for reliable, secure and low-power embedded wireless solutions. Kinetis W series MCUs are optimized for wireless, providing the right mix of performance, integration, connectivity and security. The enablement packages include Freescale's Tower System development platforms and MQX™ RTOS support, as well as support from IAR Systems and other partners. Whether you need sub-1 GHz or 2.4 GHz wireless, simple point-to-point or full mesh networking, the Kinetis W series has the solution to fit your needs.

The Kinetis KW0x Family of Sub-1 GHz MCUs

Overview

The Kinetis KW01 smart radio is an ARM Cortex-M0+-based solution designed for wireless connectivity applications. The KW01 MCU embeds a rich set of peripherals such as a high-performance bidirectional sub-1 GHz radio, capable of operating over a wide frequency range in the license-free industrial, scientific and medical (ISM) frequency bands. The KW01 smart radio supports OOK, FSK, GFSK and MSK signal modulation to transmit and receive information from 1.2 to 600 Kb/s for addressing the different types of communications required in the industrial market. An embedded front-end radio integrates high-performance, low-noise amplifiers and power amplifiers to reach a sensitivity of -120 dBm at 1.2 Kb/s and an output power adjustable from -18 to +17 dBm. The KW01 smart radio has 128 KB of on-chip, non-volatile flash memory and 16 KB of RAM for running various types of communication protocols, from proprietary protocols (simple media access controller (SMAC) to globally standardized protocols (IEEE 802.15.4). The Freescale platform approach includes hardware, software, tools and reference designs to help simplify development.

Kinetis KW0x Wireless MCU Block Diagram

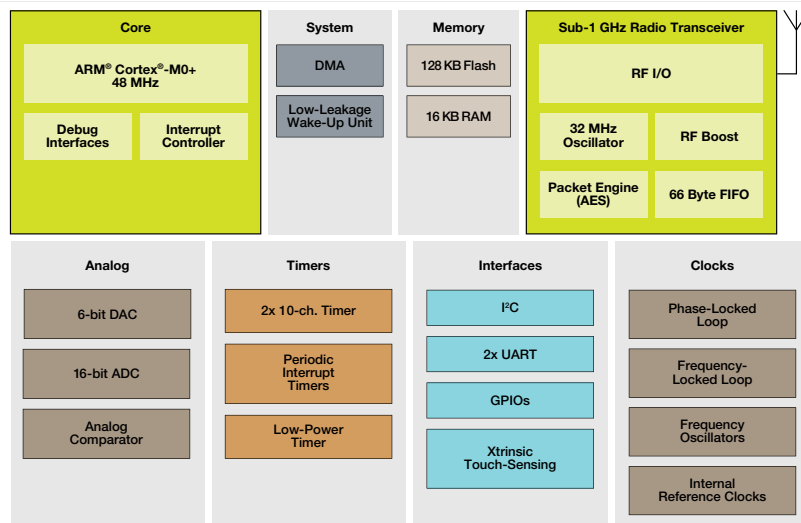

Kinetis KW2x Wireless MCU Block Diagram

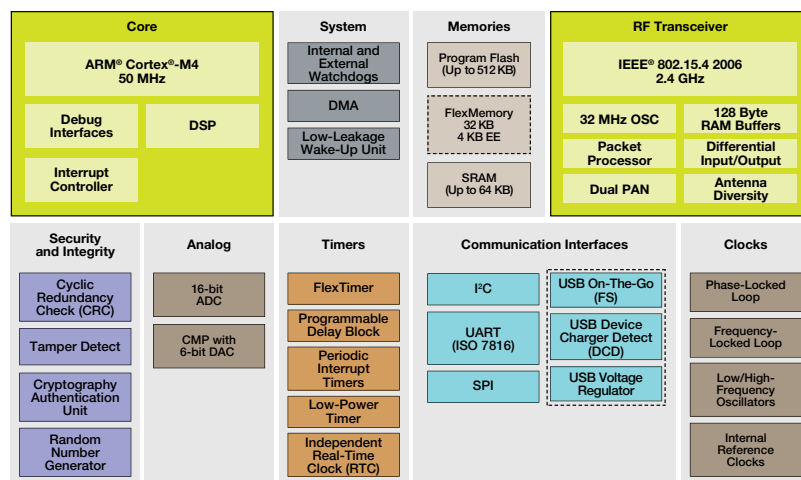

■ Freescale Technology □ Optional

Kinetis KW2x Family of 2.4 GHz RF MCUs

Overview

The Kinetis KW2x MCU integrates a class-leading 2.4 GHz RF transceiver, ARM Cortex-M4 core and a robust feature set for a reliable, secure and low-power IEEE 802.15.4 wireless solution. These wireless MCUs offer up to 512 KB of flash, 64 KB of RAM and up to 64 KB of FlexMemory.

Dual PAN support allows the system to simultaneously participate in two ZigBee® networks, eliminating the need for multiple radios. Software protocol stacks, tools, and IDEs are compatible with Kinetis MCUs. Also available are Tower System development platforms for rapid creation of embedded connectivity solutions.

To learn more, visit freescale.com/Kinetis/Wseries.

Kinetis EA Series MCUs

Built on the ARM Cortex-M0+ Core

Automotive

Kinetis EA series MCUs for automotive provide cost-effective ARM-based solutions for a wide range of automotive applications and are pin-compatible across the Kinetis EA series and with future Kinetis automotive families.

This series includes a set of analog, communication, timing and control peripherals with varying flash memory size and pin count. These scalable devices are highly robust, and offer an enhanced ESD/EMC performance solution for cost-sensitive automotive applications. This series is supported by development tools, software and hardware references to help you quickly start designing.

Features

Operating Characteristics

- Voltage range: 2.7 to 5.5 V
- Flash write voltage range: 2.7 to 5.5 V
- Temperature range (ambient): -40 °C to +125 °C

Performance

- Up to 48 MHz ARM Cortex-M0+ core
- Single-cycle 32-bit x 32-bit multiplier
- Single-cycle I/O access port

Memories and Memory Interfaces

- Up to 128 KB flash
- Up to 256 B EEPROM
- Up to 16 KB RAM

Clocks

- Oscillator (OSC)—loop-controlled Pierce oscillator, crystal or ceramic resonator range of 31.25 kHz to 39.0625 kHz or 4 MHz to 24 MHz
- Internal clock source (ICS)—internal FLL with internal or external reference, precision trimming of internal reference allowing 1% deviation across temperature range of -30 °C to 85 °C and 1.5% deviation across temperature range of -40 °C to 125 °C, up to 48 MHz
- Internal 1 kHz low-power oscillator (LPO)

Kinetis EA Series MCUs Block Diagram

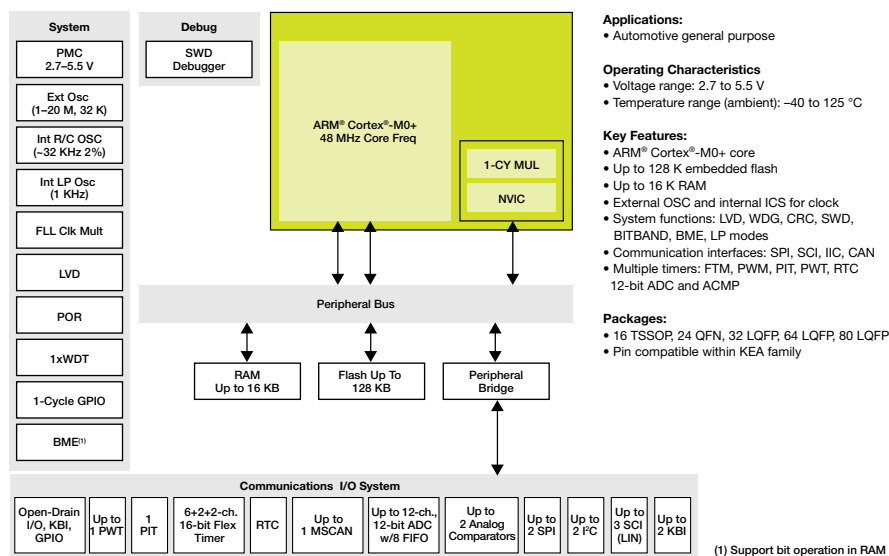

System Peripherals

- Power management module (PMC) with three power modes: run, wait, stop
- Low-voltage detection (LVD) with reset or interrupt, selectable trip points
- Watchdog with independent clock source (WDOG)
- Programmable cyclic redundancy check module (CRC)
- Serial wire debug interface (SWD)
- Bit manipulation engine (BME)

Security and Integrity Modules

- 80-bit unique identification (ID) number per chip

Human-machine interface (HMI)

- Up to 71 general-purpose input/output (GPIO)
- Up to two 32-bit keyboard interrupt modules (KBI)
- External interrupt (IRQ)

Analog Modules

- One 12 bit with up to 16 channel SAR ADC with internal band gap reference channel, operation in stop mode, optional hardware trigger (ADC)

- Two analog comparators containing a 6-bit DAC and programmable reference input (ACMP)

Timers

- One 6-channel FlexTimer/PWM (FTM)
- Up to two 2-channel FlexTimer/PWM (FTM)
- One 2-channel periodic interrupt timer (PIT)
- One real-time clock (RTC)
- Up to one 16-bit pulse width timer

Evaluation and Development Tools

- TRK-KEA8, TRK-KEA64 and TRK-KEA128 are fully featured with LIN and CAN interface (TRK-KEA128), access to all pins of the MCU, four high-efficiency LEDs, two push buttons and OpenSDA interface Reference Designs:
 - KEA128BLDCRD: 3-phase sensorless BLDC motor control
 - KEA128LEDLIGHTRD: Lighting Control Module Reference Design
 - KEA128AUTONETRD: KEAZ128 MCU implemented as a central gateway with energy saving capabilities

To learn more, visit

freescale.com/Kinetis/EAseries.

MAC5xxxx Automotive MCUs

32-bit MCUs built on ARM Cortex cores

Freescale aims to make automotive development easier with the introduction of the MAC5xxxx 32-bit ARM-based family of MCUs. Leveraging the Kinetis and i.MX portfolios, our MAC5xxxx automotive MCUs integrate Cortex-A and Cortex-M cores to deliver the right balance of real-time processing and application performance. This family of MCUs includes a broad set of documentation, hardware and software tools, as well as application notes to help speed development and reduce design costs.



MAC57D5xx DIS MCUs for Automotive Instrument Clusters

32-bit ARM-Based MCUs

Overview

The MAC57D5xx family is the next-generation platform of instrument cluster devices specifically targeted to the cluster market using single and dual high-resolution displays. Leveraging a highly successful MPC56xxS product family, Freescale is introducing a multi-core architecture powered by ARM Cortex-M (for real-time applications) and ARM Cortex-A processors (for applications and HMI), coupled with 2D graphics accelerators, a head-up display (HUD) warping engine, dual TFT display drive, integrated stepper motor drivers and a powerful I/O processor that will offer leading-edge performance and scalability for cost-effective applications.

This family supports up to two WVGA resolution displays, including one with in-line HUD hardware warping. Graphics content is generated using a powerful Vivante 2D graphics processing unit (GPU) supporting OpenVG1.1, and the 2D animation and composition engine (2D-ACE), which significantly reduces memory footprint for content creation. Embedded memories include up to 4 MB flash, 1 MB SRAM with ECC and up to 1.3 MB of graphics SRAM without ECC. Memory expansion is available through DDR2 and SDR DRAM interfaces while two flexible QuadSPI modules provide SDR and DDR serial flash expansion. In response to the growing desire for security and functional safety, the MAC57D5xx family integrates Freescale's latest SHE-compliant Cryptographic Services Engine (CSE2) engine and delivers support for ISO 26262 ASIL-B functional safety compliance.

To learn more, visit freescale.com/MAC57D5xx.

MAC57D5xx Block Diagram

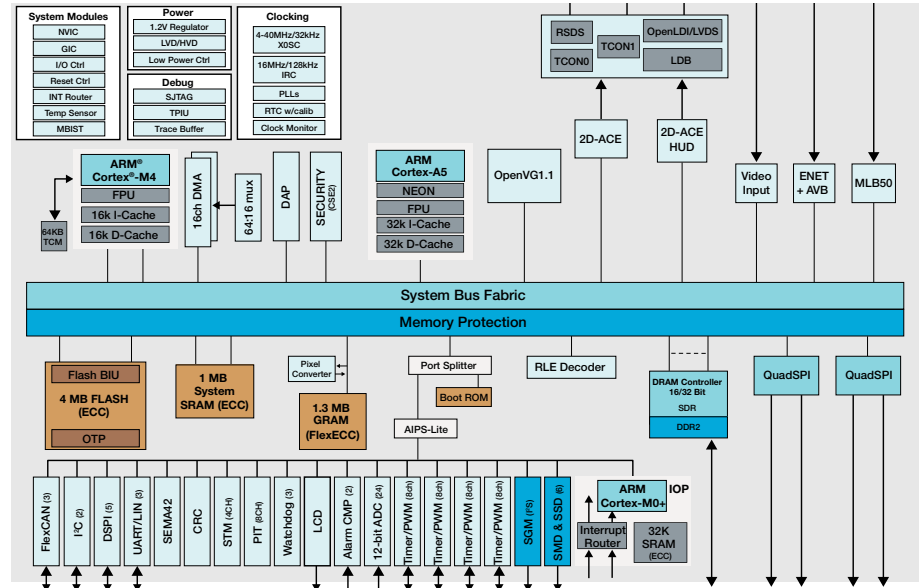

MAC57D5xx Family Matrix

FLASH	SRAM	Package Options	SDR	DDR2	Quad SPI	GPU
MAC57D54H						
4 MB	1.3 MB (non ECC)/ 2x 512 kB (with ECC)	176 LQFP	None	None	1x Dual SDR/DDR QuadSPI, 100 MHz (200 MB/s)	GC355 (OpenVG)
		208 LQFP	16-bit, 160 MHz	None	2x Dual SDR/DDR QuadSPI, 100 MHz (200 MB/s)	
		516 MAPBGA	16-bit, 160 MHz	16 or 32-bit, 320 MHz		
MAC57D53M						
3 MB	1.3 MB (non ECC)/ 2x 512 kB (with ECC)	176 LQFP	None	None	2x Dual SDR/ DDR QuadSPI, 100 MHz (200 MB/s)	GC355 (OpenVG)
		208 LQFP	16-bit, 160 MHz	None		
		516 MAPBGA	16-bit, 160 MHz	16 or 32-bit, 320 MHz		
MAC57D52L						
2 MB	1.3 MB (non ECC)/ 1x 512 kB (with ECC)	176 LQFP	None	None	1x Dual SDR/DDR QuadSPI, 100 MHz (200 MB/s)	GC355 (OpenVG)
		208 LQFP	16-bit, 160 MHz	None	2x Dual SDR/DDR QuadSPI, 100 MHz (200 MB/s)	

*Not all feature differences shown in table above, refer to data sheet for specific feature details

i.MX Applications Processors



Scalable multi-core platform with single-, dual- and quad-core families

The most versatile platform for multimedia and display applications, Freescale ARM-based i.MX processors deliver an optimal balance of power, performance and integration to enable next-generation smart devices. i.MX solutions include processors based on ARM9, ARM11, Cortex-A8 and Cortex-A9 core technologies and are powering applications across a rapidly growing number of consumer, automotive and industrial markets. Our solutions bring interactivity to a whole new world of products.

Multimedia Powerhouse

i.MX application processors have been implementing leading-edge multimedia capabilities for almost a decade by providing direct interfaces to high-end LCDs and cameras and integrating hardware acceleration for a number of advanced video codecs and graphics standards, enabling up to full HD 1080p video playback and an amazing user interface experience. Combine that with on-chip features such as the image processing unit (IPU), camera interfaces, connectivity ports and performance-enhancing capabilities such as the ARM NEON™ SIMD accelerometer and vector floating point coprocessors and i.MX applications processors become the ideal choice for customers seeking a balanced multimedia solution that offers best-in-class performance for power.

Advanced HMI

Display-centric devices across all market segments require an increasingly advanced and intuitive user interface in order to deliver the richest customer experience. The i.MX applications processor portfolio enables this experience by integrating separate graphics accelerators to support both 2D and 3D

graphics to create and deliver stunning, realistic images to LCD panels ranging from QVGA up to WUXGA resolution. By using on-chip acceleration, customers can easily add rich graphics, font rendering and enhanced web browsing with the provided device drivers and partner application software.

Energy Efficiency

i.MX applications processors deliver an optimal balance of performance and long battery life for rich multimedia experiences on the go. Plugged or unplugged, applications designed today must consider the total cost of using energy and the impact any excess

i.MX Processor Markets

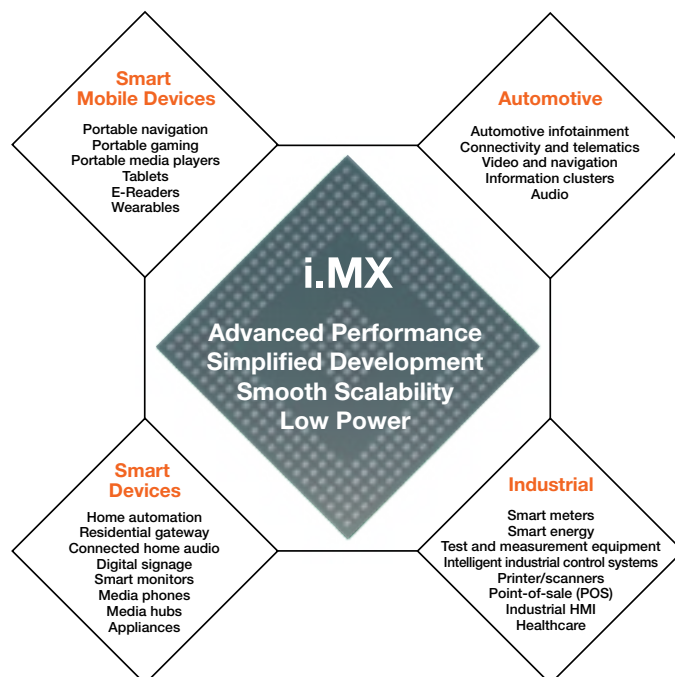

power will have on the environment. A mix of integrated power management, power optimizations such as dynamic voltage and frequency scaling, and companion PMIC solutions from Freescale ensure that the overall solution is optimized for energy efficiency and simplified implementation.

Future i.MX devices may also include a Cortex-M class processor sub-system that, combined with the main processor, will provide additional low-power modes to enable new categories of energy-efficient system awareness.

Smart Processing Solutions for the Connected World

The i.MX applications processor portfolio provides solutions across multiple market segments. With long product longevity and automotive qualification, i.MX processors are used for infotainment, gateways, connected radio and telematics systems.

The i.MX portfolio also has broad traction in the embedded market by enabling multimedia and connectivity everywhere. Example applications include medical systems for patient monitoring and diagnostics and imaging, smart energy solutions to support the global smart grid transition with smart thermostats, appliances and home energy management systems, industrial factory automation for HMI and industrial control, scanners/printers, building control, education devices and in-flight infotainment.

Connectivity and Communication

The i.MX portfolio features a number of options to support the continuously connected world. These include Ethernet with IEEE 1588 hardware time stamping for real-time control, PCIe for connecting to external FPGAs or Wi-Fi®-based modules, SD/SDIO/MMC ports for external portable data storage and connectivity to wireless modules supporting protocols such as ZigBee, Wi-Fi and Bluetooth®, USB modules with PHY for field upgradability, portable data storage and multiple serial ports to provide support for various network interfaces such as RS-232 and RS485. Additional connectivity features include I²S serial interfaces for connectivity to audio peripherals, dual CAN modules to enable industrial and automotive network bridging and interfaces for external mass storage, such as SATA.

Reliability, Safety and Security

The i.MX portfolio includes a variety of security features such as high-assurance boot, run-time integrity check, secure JTAG, secure storage, secure real-time clock and physical tamper detection. High-assurance boot with authenticity checking is used to ensure the correct software is on the correct device and is run every time the chip is reset. When it comes to security, a hardware encryption unit supports several encryption and hashing algorithms for program validation as well as authentication and securing data for transfer and storage. The tamper detection system has integrated sensors for voltage, frequency, temperature and external sensing for physical attack detection. For fail-safe applications, an independently clocked watchdog offers protection against code runaway.

Support for External Memory

i.MX application processors can interface to a variety of memories for program and data storage. Depending on the specific processor, external memory support for DRAMs includes 16-bit and/or 32-bit SDRAM, DDR1, DDR2, DDR3 and DDR3L, mDDR, LP-DDR2 and LV-DDR2 for flexibility in cost vs. performance and power.

For external flash support, i.MX processors can support a variety of NAND flash memories such as SLC, MLC or managed NANDs, as well as NOR memories. i.MX processors also provide error-correction functionality to improve the reliability of raw NAND. A parallel bus is supported for interfacing to external memory mapped peripherals such as FPGAs and ASICs.

Intelligent Integration

i.MX processors offer extensive peripheral integration, including display, cameras, connectivity, analog and security along with standard system features such as timers, pulse-width modulators, DMA and debug support. Through this intelligent integration of optimized peripherals, along with exceptional product scalability, i.MX processors reduce system-level discrete components, power consumption, board size, development effort and system cost.

i.MX 6 Series Application Processors

Scalable multi-core platform with single-, dual- and quad-core families

The i.MX 6 series features a scalable multi-core platform that includes single-, dual- and quad-core families based on the ARM Cortex-A9 architecture for next-generation consumer, industrial and automotive applications. By combining the power-efficient processing capabilities of the ARM Cortex-A9 architecture with bleeding-edge 3D and 2D graphics, as well as high-definition video, the i.MX 6 series provides a new level of multimedia performance to enable an unbounded next-generation user experience.

Complementing the industry-leading scalability of the i.MX 6 single-, dual- and quad-core offering is Freescale's PF series of power management ICs. Combined with the simplified power requirements of the i.MX 6 platforms, the PF series is capable of supplying all the voltage rails required by numerous applications, significantly reducing the bill of materials and simplifying the system design.

Target Applications

- Home automation
- Residential gateway
- Connected home audio
- E-Readers
- Wearables
- Media tablets
- Education tablets
- Digital signage
- Smart monitors
- Thin clients
- IPTV
- IP phones
- Automotive infotainment
- Aero infotainment
- Digital clusters
- Vehicle telematics
- Portable healthcare
- Test and measurement equipment
- Intelligent industrial control systems

i.MX 6 Series at a Glance

Red indicates change from column to the left

i.MX6SoloLite	i.MX6Solo	i.MX6DualLite	i.MX6Dual	i.MX6Quad
<ul style="list-style-type: none"> • Single ARM Cortex-A9 up to 1 GHz • 256 KB L2 cache, ARM NEON™, VFPv16 ARM TrustZone® • 2D graphics • 32-bit DDR3 and LPDDR2 at 400 MHz • Integrated EPD controller 	<ul style="list-style-type: none"> • Single ARM Cortex-A9 up to 1.0 GHz • 512 KB L2 cache, ARM NEON, VFPv16 ARM TrustZone • 3D graphics with one shader • 2D graphics • 32-bit DDR3 and LPDDR2 at 400 MHz • Integrated EPD controller • HDMIv1.4 controller plus PHY • LVDS controller plus PHY • PCIe controller plus PHY • MLB and FlexCAN controllers 	<ul style="list-style-type: none"> • Dual ARM Cortex-A9 up to 1.0 GHz • 512 KB L2 cache, ARM NEON, VFPv16 ARM TrustZone • 3D graphics with one shader • 2D graphics • 64-bit DDR3 and 2-channel 32-bit LPDDR2 at 400 MHz • Integrated EPD controller • HDMIv1.4 controller plus PHY • LVDS controller plus PHY • PCIe controller plus PHY • MLB and FlexCAN controllers 	<ul style="list-style-type: none"> • Dual ARM Cortex-A9 up to 1.2 GHz • 1 MB L2 cache, ARM NEON, VFPv16 ARM TrustZone • 3D graphics with four shaders • Two 2D graphics engines • 64-bit DDR3 and 2-channel 32-bit LPDDR2 at 533 MHz • Integrated SATA-II • HDMIv1.4 controller plus PHY • LVDS controller plus PHY • PCIe controller plus PHY • MLB and FlexCAN controllers 	<ul style="list-style-type: none"> • Quad ARM Cortex-A9 up to 1.2 GHz • 1 MB L2 cache, ARM NEON, VFPv16 ARM TrustZone • 3D graphics with four shaders • Two 2D graphics engines • 64-bit DDR3 and 2-channel 32-bit LPDDR2 at 533 MHz • Integrated SATA-II • HDMIv1.4 controller plus PHY • LVDS controller plus PHY • PCIe controller plus PHY • MLB and FlexCAN controllers



The market for intelligent, multimedia-centric, touch-based devices is increasing exponentially. Tomorrow's battery-powered smart devices, auto infotainment and aero infotainment systems, medical systems, personal and enterprise-class intelligent control and data systems and new classes of devices never before seen need to present data and user interface choices to the end user primarily through rich sound, video, voice, pictures and touch—rather than keyboards and mice. And the need for manufacturers to quickly provide multiple devices to fit specific market segments or niches and provide their customers with a broader range of choices is increasing just as quickly.

The i.MX 6 series was designed specifically to enable this new market by bringing together high-performance, scalable multimedia processing, a software-

compatible family of five processors and pin-compatible processor solutions with integrated power management so that a manufacturer can deploy a full portfolio of products with a single hardware design.

Scalable Multi-core Solutions

The i.MX 6 series reaches a new level of power versus performance by providing a scalable family of single-, dual- and quad-core processor families based on the ARM Cortex-A9 architecture. Single- and dual-core designs provide cost-effective performance scalability while the flagship i.MX 6Quad processor provides more performance at lower power for the most demanding applications with constrained power budgets. The pin*- and software-compatible i.MX 6 series allows designers to create a broad portfolio of products based on a

*i.MX 6SoloLite not pin compatible

i.MX 6 Series Applications Processors Block Diagram

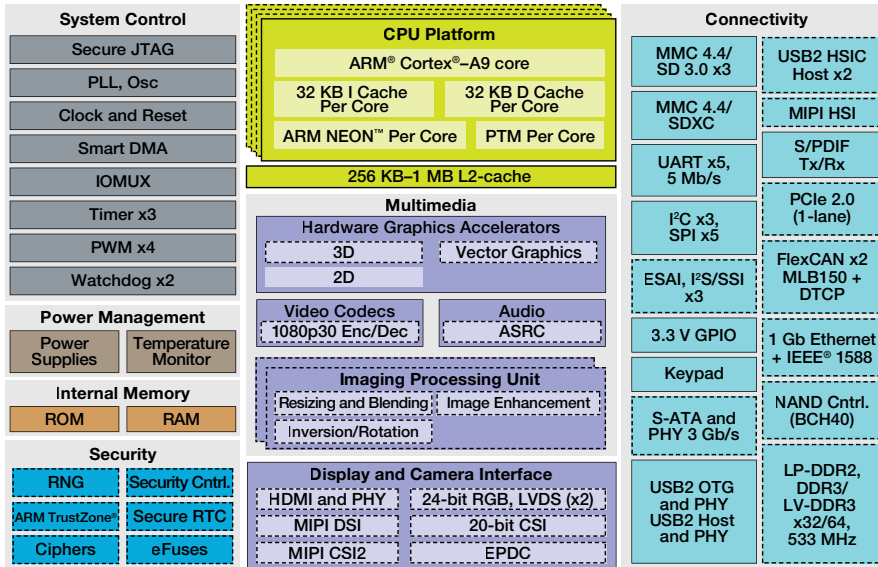

Available on certain product families

common platform while providing compelling performance advantages for systems with constrained power budgets.

Five Scalable Families

The i.MX 6Quad family encompasses a quad-core platform running up to 1.2 GHz with 1 MB of L2 cache and 64-bit DDR3/LV-DDR3 or 2-ch., 32-bit LPDDR2 support. Integrated FlexCAN, MLB busses, PCIe and SATA-2 provide broad connectivity options, while integration of LVDS, MIPI display port, MIPI camera port and HDMI v1.4 makes it an ideal platform for consumer, automotive and industrial multimedia applications.

The i.MX 6Dual family provides dual cores running up to 1.2 GHz with 1 MB of L2 cache, and 64-bit DDR3 or 2-ch., 32-bit LPDDR2 support. Leveraging the same integration of the i.MX 6Quad family, the i.MX 6Dual provides a scalable solution for consumer, automotive and industrial applications.

The i.MX 6DualLite family introduces dual cores running up to 1 GHz with 512 KB of L2 cache, and 64-bit DDR3 or 2-ch., 32-bit LPDDR2 support. With integrated FlexCAN and MLB busses, PCI Express®, LVDS, and support for MIPI cameras and displays, as well as HDMI v1.4, the device is a great fit for consumer, automotive and industrial multimedia-centric applications.

The i.MX 6Solo family provides a single core running up to 1 GHz with 512 KB of L2 cache and 32-bit DDR3/LPDDR2 support. Integrated LVDS, MIPI display, MIPI camera port, HDMI v1.4, FlexCAN and MLB enables the i.MX 6Solo to be a flexible platform for consumer, automotive and industrial applications.

The i.MX 6SoloLite family introduces a single core running up to 1 GHz with 256 KB of L2 cache and 32-bit DDR3/LPDDR2 support. Targeted integration of an electronic paper display (EPD) controller makes it an ideal solution for next-generation e-readers and other emerging consumer and embedded devices using EPD technology.

Unbound User Experience

Next-generation graphics and high-definition video are central to the i.MX 6 series.

The i.MX 6 series supports up to 1080p60 video playback, enabling exceptionally high-quality video with long battery life for devices playing high-definition content.

The 3D graphics engine in the top-of-the-line i.MX 6Quad and i.MX 6Dual processors are capable of providing up to 200 Mt/s and enables ultra-vivid, realistic graphics critical for gaming, applications that combine the power of the main cores with the until-now-untapped potential of the 3D engine to perform computational tasks. The combined multimedia processing power of the i.MX 6 series enables a new generation of smart

devices, digital displays, industrial instrumentation panels and auto and aero infotainment with compelling features such as augmented reality applications, content creation capabilities and multichannel HD video processing for a new level of user experience.

Features

- Scalable single-, dual- and quad-core offerings based on ARM Cortex-A9 up to 1.2 GHz, with ARMv7™, ARM NEON, VFPv3 and ARM TrustZone® support
- 32 KB instruction and data L1 caches and 256 KB to 1 MB of L2 cache
- Multi-stream-capable HD video engine delivering 1080p60 decode, 1080p30 encode and 3D video playback in HD in high-performance families
- Superior 3D graphics performance with up to quad shaders performing 200 MT/s
- Separate 2D and/or Vertex acceleration engines for an optimal user interface experience
- Stereoscopic image sensor support for 3D imaging
- Integrated market-specific I/Os, which may include HDMI v1.4 with integrated PHY, SD3.0, multiple USB 2.0 ports, Gigabit Ethernet, SATA-II with integrated PHY, PCI Express with integrated PHY, MIPI CSI, MIPI DSI, MIPI HSI, MLB and FlexCAN for automotive applications
- Comprehensive security features
- Optional integration of an EPD display controller for e-reader and similar applications

Software and Tools

- i.MX 6 series Freescale supported
 - SABRE for automotive infotainment
 - SABRE platform for smart devices
 - SABRE board for smart devices
 - i.MX 6SoloLite EVK
 - Google® Android™ OS
 - Linux® OS
- i.MX 6 series partner supported
 - Microsoft® Windows® Embedded CE
 - Various RTOS, embedded boards, development tools, UI tools and software and middleware offerings (See Partner Enablement Solutions.)

i.MX28 Applications Processors

Intelligent integration, unmatched

The i.MX28 family of applications processors is part of our ARM9 product portfolio. The i.MX28 family integrates display, power management and connectivity features unmatched in ARM9-based devices, reducing system cost and complexity for cost-sensitive applications. With optimized performance and power consumption, the i.MX28 is an ideal fit for battery-operated or fanless equipment. Additionally, the LCD controller with touchscreen capability makes it possible to design creative and intuitive user interfaces. The i.MX28 family reaches new levels of integration in ARM9 devices and provides the enablement needed to help design differentiated industrial, automotive and consumer products in less time.

Target Applications

- Smart appliances
- Human-machine interface for appliances, building control, factory automation, printers and security panels
- Industrial control
- Media gateways/accessories
- Portable medical
- Smart energy gateways/meters
- Automotive audio systems
- Automotive connectivity modules

Industrial Needs

Like the rest of the i.MX portfolio, the i.MX28 family provides key environmental differentiators for the industrial market. These include 3.3 V I/O support, a 0.8 mm pitch package to reduce PCB and manufacturing costs, extended temperature coverage for harsh environments, industrial qualification for extended reliability, a formal long product supply guarantee to support product life spans and a strong ecosystem, including module manufacturers, software integrators and development tools.

i.MX28 Family Block Diagram

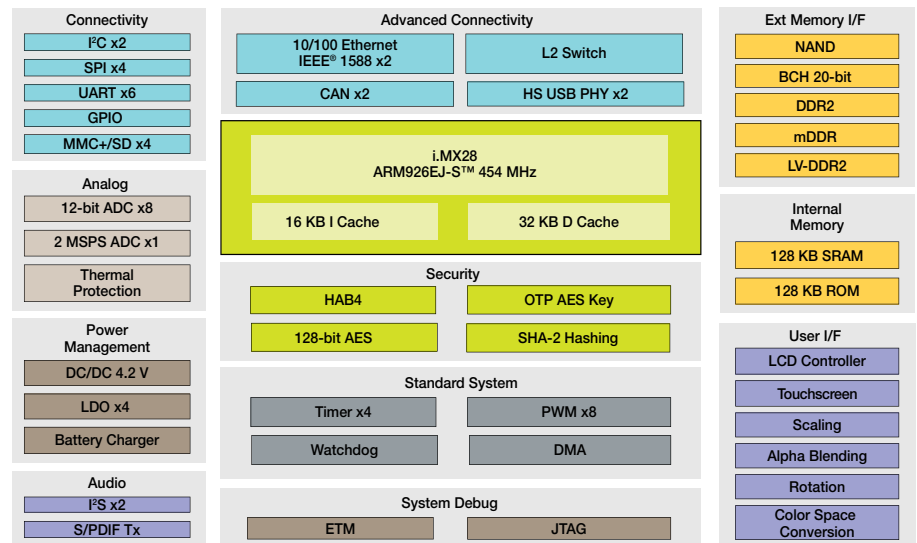

Features

- 454 MHz ARM926EJ-S™-core with 16 KB/32 KB I and D cache
- PMU to power the device and drive external components supports li-ion batteries and direct connection to 5 V supplies
- Dual IEEE 1588 10/100 Ethernet with RMIII support and L2 switch
- Dual CAN interfaces
- NAND support: SLC/MLC and eMMC 4.4 (managed NAND)
- Hardware BCH (up to 20-bit correction)
- 200 MHz 16-bit DDR2, LV-DDR2, mDDR external memory support
- Dual High-Speed USB with PHY
- Up to eight general-purpose 12-bit ADC channels and single 2 Ms/s ADC channel
- Temperature sensor for thermal protection
- Multiple connectivity ports (UARTs, SSP, SDIO, SPI, I²C and I²S)
- Product family supports various feature sets

Benefits

- Industrial-strength integration
- Reduces system cost and complexity and provides greater flexibility in system design
- Industry-leading power management eliminates external components
- High level of peripheral integration, including display, connectivity, real-time control, security and networking
- Industrial qualification and product longevity
- Supports the full life of the product in the field
- Optimized performance and power consumption
- Increased battery life for portable equipment
- Improved energy efficiency for wall-powered or fanless systems

Software and Tools

- Linux and Windows Embedded CE BSPs
- Multimedia codecs: Proven codecs enable faster time to market
- Various RTOS, embedded boards, development tools, UI tools and software and middleware offerings (See Partner Enablement Solutions.)

i.MX and QorIQ Processor Comparison



The leader in communications processors continues to accelerate the network's IQ – now with products built on the industry's first networking system architecture that supports Power Architecture® cores or ARM cores. In addition, i.MX applications processors, the most versatile platform for multimedia and display applications, offer scalability from ARM9 to Cortex-A9 cores with market-leading power, performance and integration. The QorIQ and i.MX product families have a right-sized ARM-based solution for you – from high-performance, “packet-centric” networking applications to efficient and scalable “pixel-centric” controllers.

Key Features	i.MX Applications Processors		QorIQ Communications Processors		
	i.MX 6Dual/6Quad	i.MX 6DualLite	QorIQ LS1020A	QorIQ LS1021A	QorIQ LS1022A
Core	Dual and Quad Core ARM Cortex-A9 + NEON Up to 1.2 GHz	Dual Core ARM Cortex-A9 + NEON Up to 1 GHz	Dual Core ARM Cortex-A7 MPCore + NEON Up to 1 GHz	Dual Core ARM Cortex-A7 MPCore+ NEON Up to 1 GHz	Dual Core ARM Cortex-A7 MPCore + NEON Up to 600 MHz
External Memory Interface	2x (32 B) LP-DDR2, 1x (64 B) DDR3/ Up to 533 MHz	2x (32 B) LP-DDR2, 1x (64 B) DDR3 Up to 400 MHz	1x (16/32 B + ECC) DDR3L/4 Up to 1.6 GT/s	1x (16/32 B + ECC) DDR3L/4 Up to 1.6 GT/s	1x (8/16 B) DDR3L Up to 1.3 GT/s
Graphics/ Video/ Display	LCD: Quad Display (Parallel x2, LVDS x2, MIPI-DSI, HDMI v1.4)	LCD: Dual Display (Parallel x2, LVDS x2, MIPI-DSI, HDMI 1.4)	-	2D-ACE LCD Controller Up to SXGA + 2D Graphics	-
	Graphics: 3D, 2D, OpenVG, Open GL ES 3.0, OpenCL™	Graphics: 3D, 2D, OpenVG OpenGL ES 2.0			
	Video: 1080p60 Decode, 1080p30 Encode	Video: 1080p30 Decode, 1080p30 Encode			
Ethernet MAC	1x 1 Gb IEEE 1588 Performance limited to 480 Mbps	1x 1 Gb IEEE 1588 Performance limited to 480 Mbps	3x 1 GbE, IEEE 1588 Up to 2x SGMII or 3x RGMII	3x 1GbE, IEEE 1588 Up to 2x SGMII or 3x RGMII	2x 1 GbE, IEEE 1588 2x RGMII
SATA/PCI Express	1 SATA 2.0 1 Gen-2.0 PCIe controller with one lane	1 Gen-2.0 PCIe controller with one lane	1 SATA3 2 Gen-2.0 PCIe controllers with four lane 6 GHz multi-protocol SerDes	1 SATA3 2 Gen-2.0 PCIe controllers with four lane 6 GHz multi-protocol SerDes	1 Gen. 2.0 PCIe controller with one 5 GHz SerDes lane
USB	USB 2.0 x4 1xHS OTG + PHY 1xHS Host + PHY 2x Host USB HSIC	USB 2.0 x4 1xHS OTG + PHY 1xHS Host + PHY 2x Host USB HSIC	1x USB 3.0 with PHY 1x USB 2.0 ULPI	1x USB 3.0 with PHY 1x USB 2.0 ULPI	1x USB 2.0 ULPI
Non-Multimedia Accelerators	-	-	QUICC Engine for RS485 protocol offload incl. TDM/HDLC	QUICC Engine for RS485 protocol offload incl. TDM/HDLC	-
Security/ Secure Boot/Trust Architecture	Secure Boot, Encryption/Decryption RSA, AES, ARM TrustZone, PCI v3 ready		Security Engine with IPsec acceleration Secure Boot, Trust Architecture, ARM TrustZone, Tamper Detection		

QorIQ Communications Processors



Industry's broadest portfolio, delivering unprecedented efficiency and scale for smarter, more capable networks

The QorIQ communications processor portfolio is unmatched in depth and breadth. With the addition of the next-generation QorIQ LS1 and LS2 product families built on Layerscape architecture, the portfolio extends performance from the smallest form factor, power-constrained networking applications to software-defined networking applications requiring an advanced datapath and network peripheral interfaces. These families offer optimized performance and power efficiency, plus pin compatibility, enabling customers to simply and smoothly migrate applications between these next-generation QorIQ devices. Additionally, QorIQ LS series processors deliver a unique combination of our unmatched networking expertise with ARM's extensive ecosystem.

Layerscape Architecture

Layerscape is the underlying network system architecture of the QorIQ LS series processors. The architecture enables next-generation networks with up to 100 Gb/s performance and enhanced packet-processing capabilities. Design effort is simplified with a standard, open programming model and a software-aware architecture framework that enables customers to fully exploit the underlying hardware for maximum optimization, with the capability to easily adapt to network changes for real-time "soft" control over the network. A uniform hardware and software model provides the compatibility and scalability required for customers designing end-to-end networking equipment from home- to carrier-class products. The unique, core-agnostic architecture incorporates the optimum core for the given application—ARM or Power Architecture cores.

CodeWarrior Development Studio for QorIQ LS series

CodeWarrior Development Studio for QorIQ LS series featuring ARMv7 is a development software tool created by Freescale and is based on award-winning CodeWarrior IDE technology. This software is one of the first

software tools both used and developed in lockstep with the QorIQ LS series of communications processors.

LS Tower Suite Level: This suite was created to give you an economic, yet complete full-featured development tool for when a QorIQ LS part is part of an assembled Tower System. The tools in this suite have no limitations other than they will only work with the Tower System module or kit.

Developer Suite Level: This suite is for customers who develop with multi-core processors built on ARM and Power Architecture technologies including QorIQ LS series devices and QorIQ Converge SoCs as well as DSPs based on StarCore technology. It is for designers with full system responsibility but no need for the extra costs of the specialist and architect features.

Specialists Suite Level: This suite is designed so you can do more than just compile and debug. Tools in this suite are useful for customers creating products for every market. Get all the software included in the Developer Suite plus additional board-analysis tools.

Architect Suite Level: This suite is for personnel who have a need to dig deep into the networking aspects of a development project. You will get all the software in the Specialist Suite plus software tools designed to give networking experts the extra capability to find out how their system is really working.

For more information please visit freescale.com/CWARM7.

Layerscape Architecture Elements

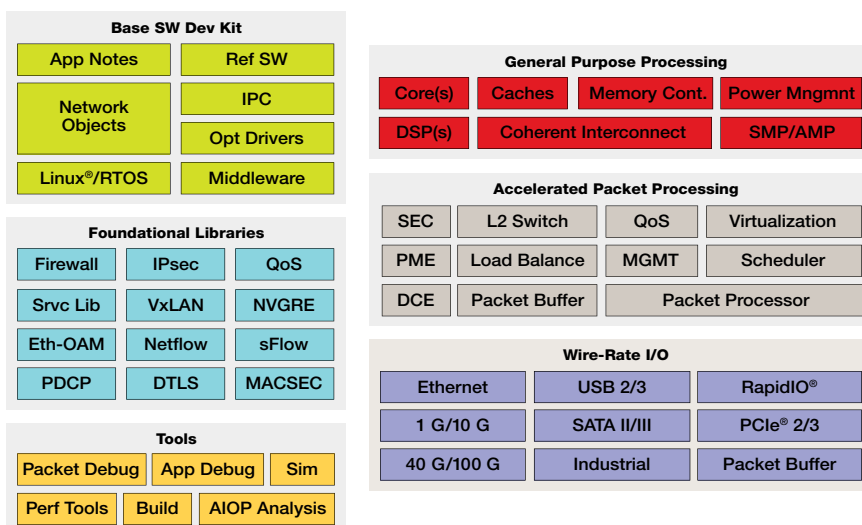

QorIQ LS1 Family

LS1020A, LS1021A and LS1022A Processors

Incorporating dual ARM Cortex-A7 cores running up to 1 GHz, the QorIQ LS1020A, LS1021A and LS1022A processors deliver extensive integration and power efficiency for fanless, small form factor networked applications. This family of processors is engineered to deliver pre-silicon CoreMark performance of over 5,000, as well as virtualization support, advanced security features and the broadest array of high-speed interconnects and optimized peripheral features ever offered in a sub-3 W processor.

LS1021A Target Applications

- Enterprise AP routers for 802.11ac/n
- Multi-protocol IoT gateways
- Industrial and factory automation
- Mobile wireless routers
- Printing
- Building automation
- Smart energy

LS1020A and LS1022A Target Applications

- Enterprise AP routers for 802.11ac/n
- I/O line cards
- Controllers
- Security appliances
- IoT gateways
- Building automation
- Smart energy

Core Complex

These processors integrate dual ARM Cortex-A7 cores running up to 1 GHz (600 MHz on the QorIQ LS1022A) with ECC-protected L1 and L2 caches, and share virtualization support and pin and software compatibility. Both ARM Cortex-A7 cores feature 32 KB of L1 instruction and data cache, share up to 512 KB of coherent L2 cache and feature the NEON SimD module and dual precision floating-point unit (FPU). The DDR memory controller supports 8-, 16- or 32-bit type 3L and 4 memory devices at up to 1600 MHz (QorIQ LS1022A limited to DDR3L at up to 1033 MHz).

QorIQ LS1020A, LS1021A and LS1022A Family Features

Dual ARM Cortex-A7 cores with frequencies up to 1 GHz	Extreme power efficiency, delivering pre-silicon performance at over 5,000 CoreMarks. Typical Total System Power of 3 W for improved performance without increased power utilization
ECC-protected L1 and L2 cache memories	Only processor family in its class with ECC-protected caches and coherent 512 KB L2, adding performance and meeting networking requirements for high reliability
Support for hardware-based virtualization	Enables partitioning of CPU resources on low-power parts for increased system productivity
Integrated security engine, supporting Secure Boot and Trust Architecture	Based on the QorIQ SEC 5.5 hardware accelerated security engine, to provide in depth defense for customer applications
Rich connectivity and peripheral features including PCI Express Gen2, USB 3.0, SATA3, IFC, QuadSPI, CAN	High versatility that enables support for 802.11ac modules and high bandwidth connectivity for ASICs, 4G/LTE, SATA, low-cost NAND/NOR flash
LCD controller (DCU5)	Touchscreen support adds integrated HMI features for enhanced ease of use and BOM savings. Similar IP as Freescale Vybrid controller solutions and i.MX applications processors to allow for simple software migration.
QUICC Engine technology	Proven support for required industrial, building and factory protocols such as PROFIBUS, HDLC, TDM
DDR3L/4 memory	First in its class to offer support for DDR4 memory, ensuring continued performance efficiency

QorIQ LS1021A Processor Block Diagram

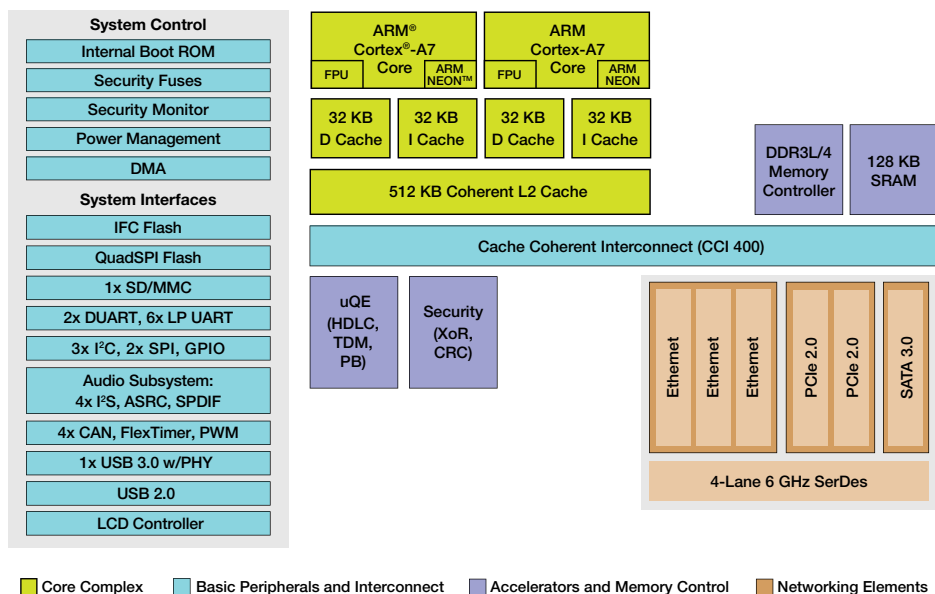

System Interfaces and Networking

QorIQ LS1021A processors feature a four-lane, 6 GHz multi-protocol SerDes that provides support for high-speed interfaces, including up to three Gigabit Ethernet ports with IEEE 1588 support, dual DMA-controlled PCI Express generation 2.0 ports and a single SATA 3.0 port. The QorIQ LS1021A processors also feature dual USB controllers—one supporting SuperSpeed USB 3.0 with integrated PHY, the other supporting USB 2.0 functions. Additional interfaces include QuadSPI, IFC and support for SD/MMC. For network audio applications, the QorIQ LS1021A processors include support for both ASRC and SPDF. For industrial and power-constrained applications, the processors provide four CAN ports and up to 10 UARTS to support industrial protocols. In addition, Serial I/O includes three I²C and two SPI interfaces.

Complete Enablement

For customer evaluation, the QorIQ LS1 family is supported by the TWR-LS1021A development module for rapid prototyping for industrial control and IoT applications. Based on the modular Freescale Tower System, the TWR-LS1021A enables compatibility and interoperability with the growing list of Tower System peripheral modules, providing an easily accessible and interchangeable suite of capabilities and features to support rapid prototyping as well as software development programs.

In addition to high efficiency, integration and reliability delivered by the LS1021A processor, the TWR-LS1021A platform provides a comprehensive level of security which includes support for secure boot, Trust Architecture and tamper detection, in both standby and active power modes. Together, these features safeguard the device from the point of manufacture to the point of deployment.

The TWR-LS1021A kit includes a Linux 3.12 SDK with optimized drivers and a free 90-day evaluation license for CodeWarrior development tools for ARM.

Learn more at freescale.com/Tower.

TWR-LS1021A: Tower System Processor Module

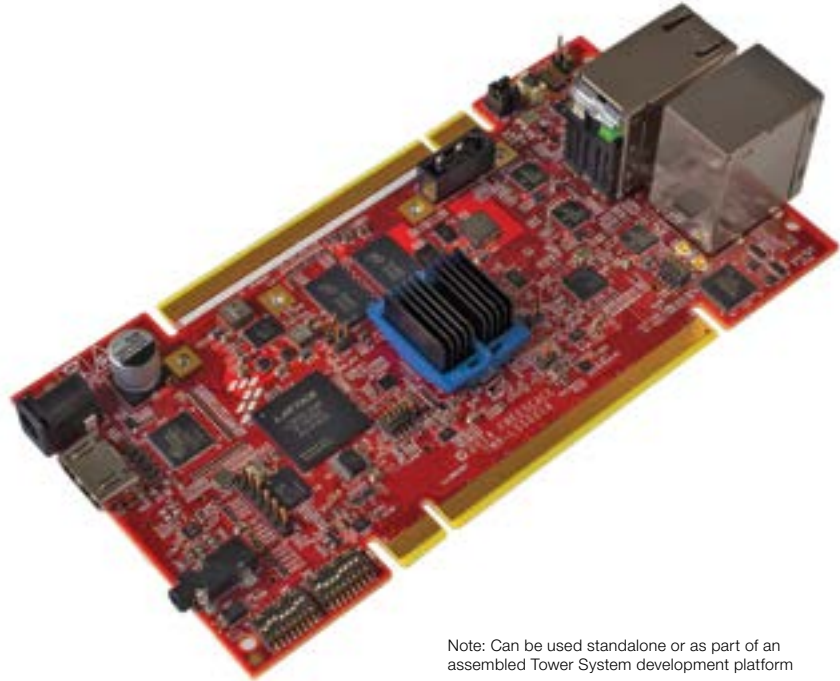

Note: Can be used standalone or as part of an assembled Tower System development platform

QorIQ LS1 Family

LS1024A and LS102MA Processors

The QorIQ LS1024A and LS102MA system-on-chip (SoC) communications processors deliver vastly increased processing power and VoIP density, wire speed handling of small packets, DRM-compliant security and enterprise-grade VPN and SSL throughput. Specifically optimized for low-end applications that require enterprise-class performance in a cost-effective envelope, these processors allow considerable system cost savings due to the integration of new features that are emerging in the CPE market.

In addition to providing high throughput IPsec and SSL CPU offload, the QorIQ LS1024A communications processor includes an onboard security engine with a powerful Deep Packet Inspection engine and GZIP decompression capability. The LS102MA device's optimized packet and QoS coprocessor provide needed Layer 2/3/4 acceleration with hardware assist for queuing, classification, marking, scheduling and rate limiting. Together, these processors target a wide variety of applications including high-end VoIP-enabled home gateways, IoT gateways and network attached storage appliances.

LS1024A and LS102MA Target Applications

- High-end VoIP and video-enabled home gateways
- Small- to mid-sized business (SMB) high-performance security appliances
- Ethernet-powered 802.11n enterprise access points
- Consumer networked storage products
- Secure payment terminals
- Smart energy (LS102MA)

Core Complex

The QorIQ LS1024A and LS102MA communications processors leverage the energy efficiency of ARM technology and a low-power design process to achieve the lowest power consumption in its class (<2 W typical at 900 MHz for LS1024A; <1.5 W typical @ 650 MHz for LS102MA). In order to provide performance scalability

QorIQ LS1024A Communications Processor Block Diagram

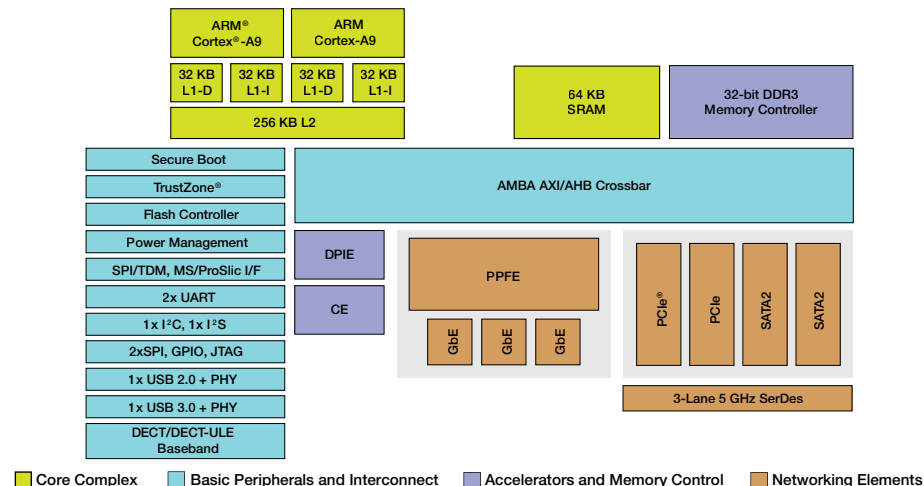

QorIQ LS102MA Communications Processor Block Diagram

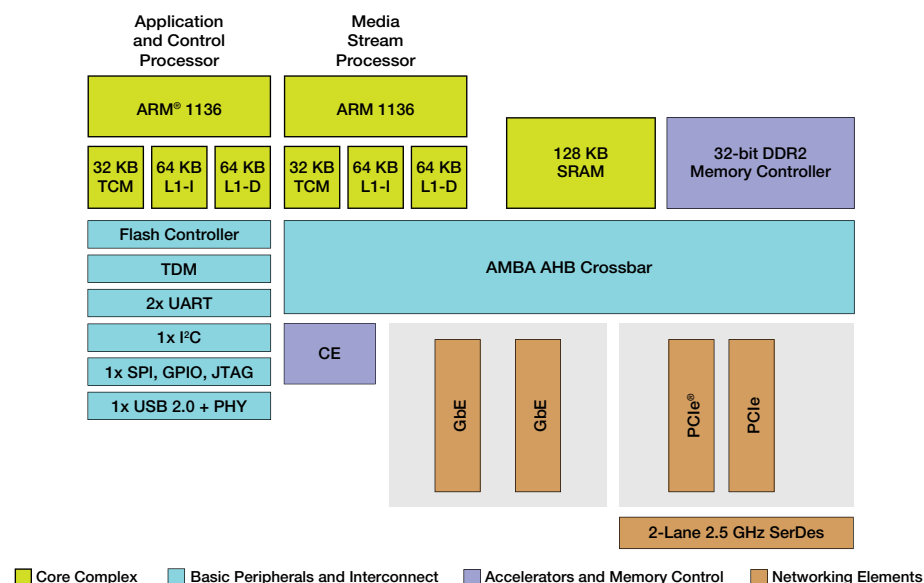

and maximum flexibility, the LS1024A communications processor includes dual ARM Cortex-A9 cores ranging from 650 MHz to 1.2 GHz delivering up to 6000 DMIPS; the LS102MA processor includes single and dual ARM11 core devices from 450 MHz to 650 MHz delivering up to 1600 DMIPS.

System Interfaces and Networking

The QorIQ LS1024A communications processor includes I/O interfaces in conjunction with the innovative multilayer

bus architecture that allows non-blocking concurrent transactions across all data interfaces, thus minimizing on-chip packet processing latency. The SATA-2 interfaces, along with the powerful processing engine and integrated RAID controller, provide an ideal solution for network attached storage application. The LS102MA processor provides Ethernet, PCIe, TDM, USB 2.0 interfaces for a complete set of data interfaces which deliver a system BOM cost reduction by simplifying and thus minimizing PC board design requirements.

QorIQ LS2 Family

LS2045A and LS2085A Processors

The QorIQ LS2 family of processors delivers unprecedented performance and integration for the smarter, more capable networks of tomorrow. The QorIQ LS2045A and LS2085A multi-core processors combine four and eight ARM Cortex-A57 cores respectively with the advanced, high-performance datapath and network peripheral interfaces required for networking, telecom/datacom, wireless infrastructure, military and aerospace applications.

The next-generation datapath architecture combined with a powerful software toolkit provides a higher level of hardware abstraction and makes software development quick, easy and simple. This combination balances ease-of-use with high performance processing in a Linux environment that is familiar to any software programmer. Design effort is simplified with a standard, open programming model and a software-aware architecture that enables customers to fully exploit the underlying hardware and easily adapt to network changes for real-time 'soft' control over the network.

Target Applications

- SDN/OpenFlow™ switching
- NFV solutions
- Wireless access
- Enterprise routing
- Datacenter processing
- Military and aerospace

Unparalleled Integration

QorIQ LS2 family processors integrate up to eight 10 Gb/s and eight 1 Gb/s Ethernet interfaces with L2 switching capability for PCIe® controllers (supporting SR-IOV) and next-generation SATAIII and USB3 controllers. The next-generation datapath is complimented with high-performance acceleration, including security and trust, pattern matching and data compression.

QorIQ LS2 Family Features

Up to 8 Cores Built on ARM Architecture	<ul style="list-style-type: none"> • 8x ARM Cortex-A57 CPUs, 64-bit, 2 GHz, clusters of two cores sharing 1 MB L2 cache • 1 MB L3 cache and 4 MB of cache component memory
Hierarchical Interconnect Fabric	<ul style="list-style-type: none"> • Coherency fabric supporting coherent and non-coherent transactions with prioritization and bandwidth allocation
DDR Controllers	<ul style="list-style-type: none"> • Two 64-bit DDR4 SDRAM memory controllers with ECC and interleaving support, up to 2.1 GT/s • One secondary 32-bit DDR4 memory controller for the accelerated packet processing layer, up to 1.6 GT/s
Accelerated Packet Processing	<ul style="list-style-type: none"> • Accelerated I/O processing, up to 40 Gb/s complex forwarding • 20 Gb/s SEC crypto acceleration • 10 Gb/s Pattern Matching Engine • 20 Gb/s Data Compression Engine
Express Packet I/O	<ul style="list-style-type: none"> • Supports 1x8, 4x4, 4x2, 4x1 PCIe Gen 3 controllers • SR-IOV support, Root Complex • 2x SATA 3.0, 2x USB 3.0 with PHY
Network I/O	<ul style="list-style-type: none"> • Wire rate I/O processor, featuring: <ul style="list-style-type: none"> ◦ Eight 1/10 GbE + eight 1 G ◦ L2 switching on the Ethernet interface ◦ XAUI/XFI/KR and SGMII ◦ MACSec on up to four 1/10 GbE
Virtualization	<ul style="list-style-type: none"> • Support for HW virtualization and partitioning enforcement

QorIQ LS2085A Processor Block Diagram

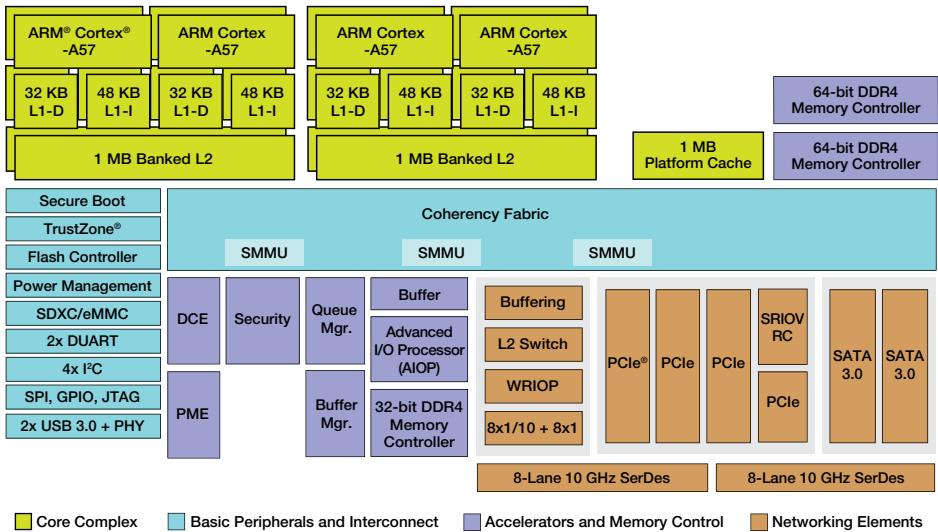



Networking Performance

QorIQ LS2 processors provide 40 Gb/s of advanced packet processing performance for Complex IP forwarding (four lookups + one ACL per packet). The next-generation datapath also provides necessary and proven acceleration such as crypto acceleration, Pattern Match/RegEx and Data Compression Engine. A new feature of the QorIQ LS series processors based on the Layerscape architecture technology is a full-feature L2 switch that works across all eight 10 Gb/s Ethernet interfaces and the eight additional 1 Gb/s Ethernet interfaces for a combined switching rate of 88 Gb/s L2 switching. A dedicated memory controller for the datapath assures that ample DDR bandwidth is available for the lookup acceleration and packet processing needs.

Complete Enablement, Rich Ecosystem

The QorIQ LS2 family includes a comprehensive ecosystem to assure that ease-of-use is first priority. The complete offering includes:

- APIs that are compliant with industry-standard consortiums
- Management software that takes care of setup, initialization and tear down of interfaces, accelerators and networking functions
- Functional datapath libraries that are performance optimized
- Freescale VortiQa software applications that are bundled for quick networking application deployment
- Tools (e.g., accelerators, debug) to make sure you spend your time creating value added software
- Powerful combination of Freescale and ARM ecosystems for best-in-class support
- Open-source software, available upstream for all customers to leverage

For more information, please visit freescale.com/QorIQ.

QorIQ LS2 Family Features

Up to 8 Cores Built on ARM Architecture	<ul style="list-style-type: none"> • 8x ARM Cortex-A57 CPUs, 64-bit, 2 GHz, clusters of two cores sharing 1 MB L2 cache • 1 MB L3 cache and 4 MB of cache component memory
Hierarchical Interconnect Fabric	<ul style="list-style-type: none"> • Coherency fabric supporting coherent and non-coherent transactions with prioritization and bandwidth allocation
DDR Controllers	<ul style="list-style-type: none"> • Two 64-bit DDR4 SDRAM memory controllers with ECC and interleaving support, up to 2.1 GT/s • One secondary 32-bit DDR4 memory controller for the accelerated packet processing layer, up to 1.6 GT/s
Accelerated Packet Processing	<ul style="list-style-type: none"> • Accelerated I/O processing, up to 40 Gb/s complex forwarding • 20 Gb/s SEC crypto acceleration • 10 Gb/s Pattern Matching Engine • 20 Gb/s Data Compression Engine
Express Packet I/O	<ul style="list-style-type: none"> • Supports 1x8, 4x4, 4x2, 4x1 PCIe Gen 3 controllers • SR-IOV support, Root Complex • 2x SATA 3.0, 2x USB 3.0 with PHY
Network I/O	<ul style="list-style-type: none"> • Wire rate I/O processor, featuring: <ul style="list-style-type: none"> ◦ Eight 1/10 GbE + eight 1 G ◦ L2 switching on the Ethernet interface ◦ XAU/XFI/KR and SGMII ◦ MACSec on up to four 1/10 GbE
Virtualization	<ul style="list-style-type: none"> • Support for HW virtualization and partitioning enforcement

Vybrid Controller Solutions



A multi-core platform for industrial applications

The increasing complexity and demands of embedded systems create greater need for sophisticated human-machine interfaces (HMI) and multiple connectivity options with safe, secure and predictable operation. To concurrently provide rich HMI and real-time control means bringing together two very different system paradigms. For example, HMI computation focuses on efficiently processing pixels and displaying them on a screen, while guaranteed determinism requires highly predictable response times for tasks.

A traditional systems-level solution for such divergent needs would combine different pieces of silicon, such as an applications MPU and a real-time MCU, on a board. It would also require developing software and a protocol to enable simultaneous communication between real-time control and rich HMI. Application developers face the tremendous challenge of seamlessly integrating these diverse technologies in a single system.

Our Vybrid portfolio brings to market a unique, low-power system solution that provides customers a way to combine rich applications requiring high-resolution graphical displays and connectivity with real-time determinism. The Vybrid portfolio enables customers to create systems that concurrently run a high-level operating system such as Linux and a real-time operating system such as MQX on the same device. This, along with a communication API between the rich domain, the real-time domain and a tool chain that eases debug of such systems, dramatically shortens customer time to revenue. The families in the Vybrid portfolio span entry-level products for customers who want to upgrade from the Kinetis MCU to devices with large on-chip SRAM up to highly integrated, dual-core solutions intended to serve industrial markets.

Vybrid Families

	DDR	Camera Interface	Video ADC	USB Host w/PHY	USB OTG w/PHY	Segment LCD	TFT LCD	Ethernet Controller	L2 Switch	Security (HAB, Tamper, Det.)	External Bus
VF6xx Family [Heterogenous Dual Core] ARM Cortex-A5 up to 500 MHz ARM Cortex-M4 up to 167 MHz 364-pin MAPBGA	●	●	●	●	●	○	2	2	●	●	●
VF5xx Family ARM Cortex-A5 up to 500 MHz 364-pin MAPBGA	●	●	○	●	●	○	●	2	●	●	●
VF3xx Family ARM Cortex-A5 up to 266 MHz 176-pin LQFP	○	●	○	○	●	●	●	2	●	●	●

Common Platform, Analog and Digital		Tools
CRC and TZ Address Space Controllers	12-bit ADC	Packaged IDE
I ² C	12-bit DAC	
Programmable Delay Block	Secure JTAG	Packaged OS and Multicore Communication API
Flash Controller	Secure Fuses	
UARTs	Timers	Application Software Industrial Protocols Peripheral Drivers
Low-Voltage, Low-Power Multiple Operating Modes, Clock Gating (1.73–3.6 V)	Secure RAM	
	eSDHC	
ESAI	DMA	Third-Party Ecosystem Support
	SRAM	

Vybrid Controller Solutions Core Architecture

Vybrid devices have a dual-core architecture that combines the Cortex-A5 application processor and the Cortex-M4 for real-time control. The Vybrid portfolio is designed to be a transitional product from Kinetis MCUs featuring the Cortex-M4 core and the i.MX 6 series featuring the Cortex-A9 core, while also providing scalable devices that can address the needs of a market that demands critical safety and security, connectivity and rich HMI in the same piece of silicon. The Vybrid road map is built with this scalability and code compatibility in mind so that the performance of the device road map grows with the customer's needs long into the future.

One of the key benefits of combining the Cortex-A5 core with the Cortex-M4 core is the partitioning of tasks based on their characteristics. For example, for tasks that need predictable interrupt management—a typical need for real-time applications—the Vybrid platform has the Cortex-M4 core with a Nested Vector Interrupt Controller (NVIC). This allows graphical applications and connectivity stacks to be run on the Cortex-A5 applications processor.

Software can be segmented so that tasks that need predictable latencies can be run on the Cortex-M4 core and computer-intensive processes run on the Cortex-A5 core.

Cortex-A5 Core

The Cortex-A5 processor is a high-performance, low-power core with an L1 and L2 cache subsystem that provides full virtual memory capabilities, a double-precision floating-point unit (FPU) and the ARM NEON media processing engine. It is intended as an upgrade for the ARM9 and ARM11 cores and is architecturally compatible with Cortex-A9. The Cortex-A5 also has ARM TrustZone technology for creating secure applications.

Cortex-M4 Core

The Cortex-M4 core retains all the advantages of the Cortex-M3 core with an NVIC, which gives the deterministic interrupt handling capability demanded by real-time applications along with tightly coupled memory (TCM). Determinism is a factor of NVIC plus TCM. The Cortex-M4 adds digital signal processing (DSP) capability in the form of DSP and SIMD instruction extensions, a single-cycle MAC unit and single-precision FPU. In addition, Freescale

Tower System Development Platforms for Vybrid Controllers

Part Number	Features
TWR-VF65GS10	<ul style="list-style-type: none"> TWR-VF65GS10 module, USB cable, quick start guide Complimentary one-year, nonrenewable license to ARM Development Studio 5 (DS-5™) starter kit for Vybrid controller Tower System module (256 KB code size limitation)
TWR-VF65GS10-KIT	<ul style="list-style-type: none"> TWR-VF65GS10 module, USB cable, quick start guide Complimentary one-year, nonrenewable license to ARM Development Studio 5 (DS-5) starter kit for Vybrid controller Tower System module (256 KB code size limitation) TWR-ELEV elevator modules TWR-SER serial module
TWR-VF65GS10-PRO	<ul style="list-style-type: none"> TWR-VF65GS10 module, USB cable, quick start guide Complimentary one-year, nonrenewable license to ARM Development Studio 5 (DS-5) starter kit for Vybrid controller Tower System module (256 KB code size limitation) TWR-ELEV elevator modules TWR-SER2 enhanced serial module TWR-LCD-RGB graphical LCD module
TWR-VF65GS10-DS5	<ul style="list-style-type: none"> Same as TWR-VF65GS10-PRO, except it includes one-year, renewable license for ARM Development Studio 5 (DS-5) Vybrid controllers edition (hardware platform independent, 1 MB code size limitation)

Note: These Tower System modules and kits support all Vybrid family controllers (VF3xx, VF5xx, and VF6xx)

has added a direct memory access (DMA) controller, crossbar switch and L1 on-chip cache memories, maximizing processor performance and bus bandwidth.

Reliability, Safety and Security

Vybrid devices include a variety of data integrity and security hardware features for safeguarding memory, communication and system data. A cyclic redundancy check module is available for validating memory contents and communication data, while a memory protection unit provides data protection and increased software reliability. For fail-safe applications, an independently clocked watchdog offers protection against runaway code. When it comes to security, a hardware encryption unit supports several encryption and hashing algorithms for program validation as well as authentication and securing data for transfer and storage. The system security module includes a unique chip identifier, secure key storage and a hardware tamper detection system. The tamper detection system has integrated sensors for voltage, frequency, temperature and external sensing for physical attack detection.

Optimal System Performance

Vybrid devices are ideal for modern industrial applications that require higher integration of communication and connectivity interfaces, as well as HMI and UI acceleration. Customers can easily take full advantage of all the integrated Vybrid features to create differentiated products by leveraging the

provided reference board support packages (BSP) for high-level operating systems (such as Linux) and real-time operating systems (such as MQX) that include libraries and media frameworks tuned to the silicon architecture. The combination of high-efficiency silicon design, low-leakage process technology and software tuned for the silicon architecture results in low power consumption, eliminating the need for a fan or heat sink and helping to lower overall system BOM cost. As an example, because the platform architecture partitions tasks between the applications processor and the deterministic MCU, the Cortex-M4 core helps to improve efficiency in industrial motor control applications that can result in a reduced carbon footprint.

Get Started Today

The Freescale Tower System provides a modular and expandable development platform for evaluating and prototyping with Vybrid controller solutions. The TWR-VF65GS10 module is a development tool for the Vybrid family of controllers that operates as a standalone debug tool or as part of an assembled Tower System development platform. With full support from MQX Software Solutions, Timesys Linux BSP and the ARM DS-5 toolchain, your next application-rich design is at your fingertips. For more information, visit freescale.com/TWR-VF65GS10 and freescale.com/TWR-VF65GS10-DS5.

Vybrid VF3xx Family

Single-core solution with dual XiP quad SPI, dual Ethernet and L2 switch for appliances and energy control

The VF3xx family is the entry point into the Vybrid portfolio and features the Cortex-A5 core. It provides an efficient solution for an applications processor with up to 1.5 MB of on-chip SRAM and a rich suite of communication, connectivity and human-machine interfaces (HMI).

Target Applications

- Industrial automation
 - Applications requiring simple 2D graphics (HMI)
- Industrial scanners and printers
- Large or high-quality small appliances
- Portable patient monitors
- Simple vending machines

Mixed-Signal Capability

- Two 12-bit ADCs with configurable resolution. Single or differential output mode operation for improved noise rejection. 500 ns conversion time achievable with programmable delay block triggering.
- Two 12-bit DACs for analog waveform generation for audio applications or sensor manipulation

Memory

- Dual quad SPI supporting a double data rate interface, an enhanced read data buffering scheme, execute-in-place (XiP) and support for dual-die flashes
- Boot ROM with optional high-assurance boot for secure booting capability
- 1.5 MB on-chip SRAM with ECC support on 512 KB

Vybrid VF3xx Family Block Diagram

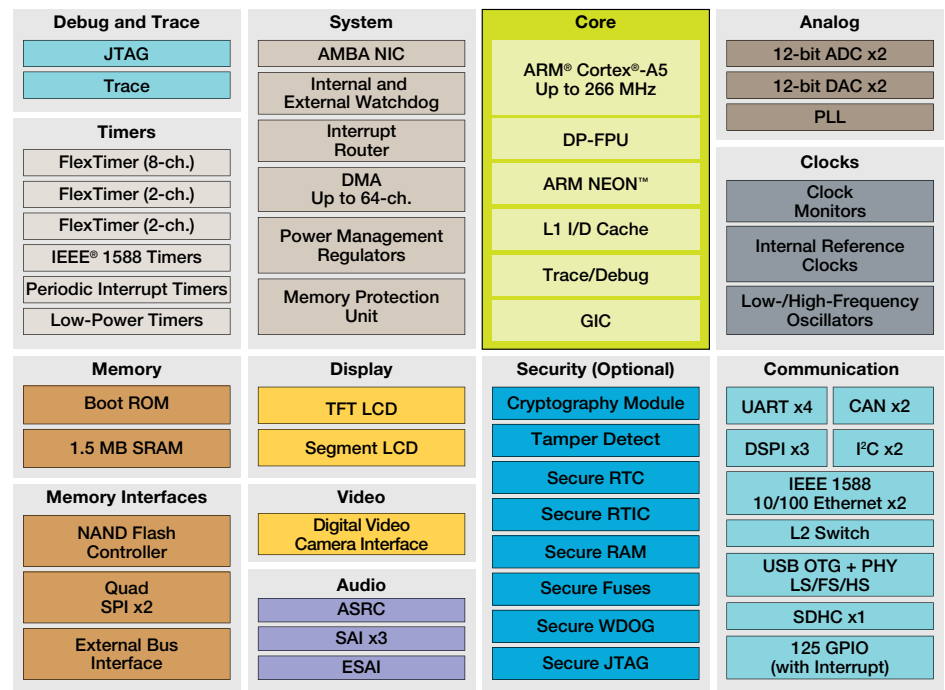

Performance

- Cortex-A5 core running at 266 MHz, with double-precision floating-point, ARM NEON media processing engine for acceleration of media and signal processing, and ARM TrustZone security extensions. 32 KB each of instruction and data L1 cache and 512 KB L2 cache for optimized bus bandwidth and on-chip SRAM execution performance.
- Up to 64-channel DMA for peripheral and memory servicing with reduced CPU loading and faster system throughput
- Crossbar switch enables concurrent multi-master bus accesses, increasing bus bandwidth

Timing and Control

- Three FlexTimers with a total of 12 channels. Hardware dead-time insertion and quadrature decoding for motor control
- Four-channel 32-bit periodic interrupt timer provides time base for RTOS task scheduler or trigger source for ADC conversion and programmable delay block

HMI

- TFT LCD display capable of WQVGA resolution
- 288 segment LCD controller

For more information, please visit freescale.com/VF3xx.

Hybrid VF5xx Family

Single-core solution with dual Ethernet and L2 switch for automation and control

The VF5xx family features the Cortex-A5 core with speeds up to 500 MHz with 512 KB L2 cache, dual USB 2.0 OTG controllers with integrated PHY, dual 10/100 Ethernet controllers with L2 switch, up to 1.5 MB of on-chip SRAM and a rich suite of communication, connectivity and human-machine interfaces (HMI). The VF5xx family is pin and software compatible with the VF6xx family.

Target Applications

- Industrial automation
 - Applications requiring simple 2D graphics (HMI)
- Industrial scanners and printers
- Industrial vehicle control with HMI
- Large or high-quality small appliances
- Metering
 - Data concentrator
- Portable patient monitors
- Simple vending machines

Mixed-Signal Capability

- Two 12-bit ADCs with configurable resolution. Single or differential output mode operation for improved noise rejection. 500 ns conversion time achievable with programmable delay block triggering.
- Two 12-bit DACs for analog waveform generation for audio applications or sensor manipulation

Memory

- Dual quad SPI supporting a double data rate interface, an enhanced read data buffering scheme, execute-in-place (XiP) and support for dual-die flashes
- Boot ROM with optional high-assurance boot for secure booting capability
- Up to 1.5 MB on-chip SRAM with ECC support on 512 KB

Hybrid VF5xx Family Block Diagram

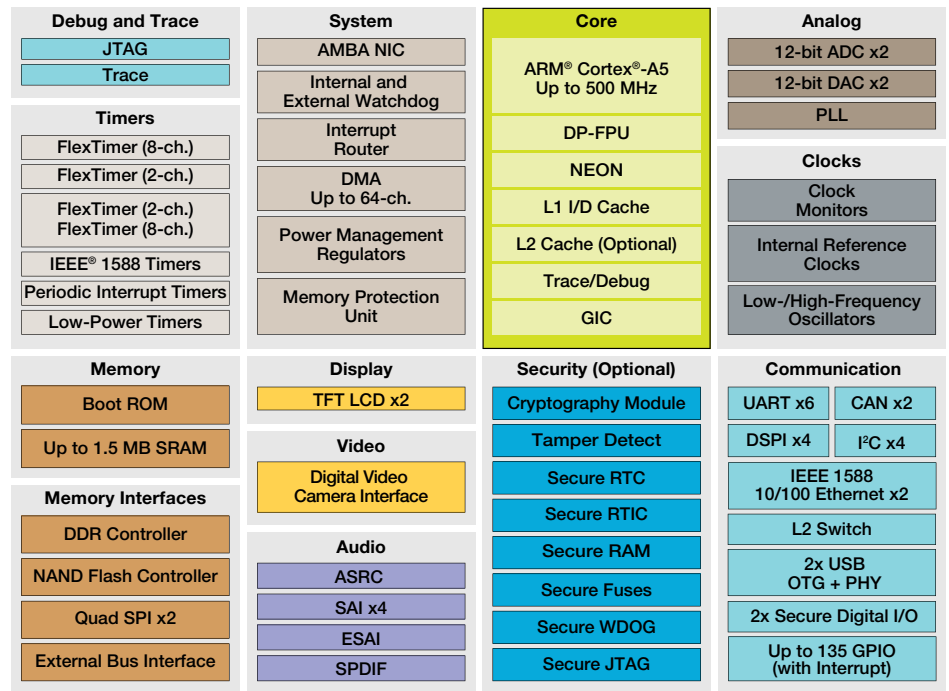

- 16-bit DDR controller with PHY and ECC support capable of DDR3/LPDDR2 800 MHz data rate

Performance

- Cortex-A5 core with frequency up to 500 MHz, with double-precision floating-point, ARM NEON media processing engine for acceleration of media and signal processing, and ARM TrustZone security extension. 32 KB each of instruction and data L1 cache and 512 KB L2 cache for optimized bus bandwidth and on-chip SRAM execution performance.
- Up to 64-channel DMA for peripheral and memory servicing with reduced CPU loading and faster system throughput

- Crossbar switch enables concurrent multi-master bus accesses, increasing bus bandwidth

Timing and Control

- Four FlexTimers with a total of 20 channels. Hardware dead-time insertion and quadrature decoding for motor control.
- Four-channel 32-bit periodic interrupt timer provides time base for RTOS task scheduler or trigger source for ADC conversion and programmable delay block

HMI

- TFT LCD displays capable of XGA resolution

For more information, please visit freescale.com/VF5xx.

Vybrid VF6xx Family

Dual heterogeneous core solution with XGA display, dual USB, dual Ethernet and L2 switch for automation and HMI

The VF6xx is the heterogeneous dual-core family combining the Cortex-A5 and Cortex-M4 cores. It includes dual USB 2.0 OTG controllers with integrated PHY, dual 10/100 Ethernet controllers with L2 switch, up to 1.5 MB of on-chip SRAM and a rich suite of communication, connectivity and human-machine interfaces (HMI).

Target Applications

- Motor drives
- Industrial pumps and fans
- Power inverters
- Mobile patient care
 - Infusion pumps and respirators
- Energy grid protection
 - Circuit breakers, monitors and hubs
- Infrastructure control
 - Water treatment and gas pipelines
- Building control
 - Elevator and automated doors
- Kiosks with 2D displays
- Service robots

Mixed-Signal Capability

- Two 12-bit ADCs with configurable resolution. Single or differential output mode operation for improved noise rejection. 500 ns conversion time achievable with programmable delay block triggering.
- Two 12-bit DACs for analog waveform generation for audio applications or sensor manipulation

Memory

- Dual quad SPI supporting a double data rate interface, an enhanced read data buffering scheme, execute-in-place (XiP) and support for dual-die flashes
- Boot ROM with optional high assurance boot for secure booting capability
- Up to 1.5 MB on-chip SRAM with ECC support on 512 KB

Vybrid VF6xx Family Block Diagram

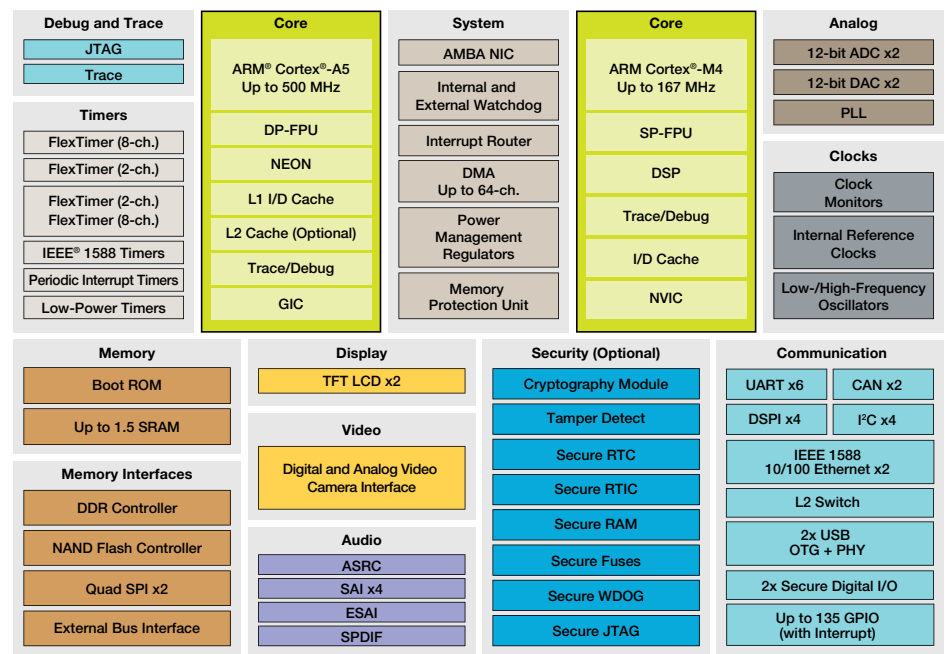

- 16-bit DDR controller with PHY and ECC support capable of DDR3/LPDDR2 800 MHz data rate

Performance

- Cortex-A5 core with frequency up to 500 MHz, with 32 KB each instruction and data L1 cache and 512 KB L2 cache double-precision floating-point, ARM NEON media processing engine for acceleration of media and signal processing, and ARM TrustZone security extension
- Cortex-M4 core running up to 167 MHz, with 16 KB of instruction/data L1 cache plus 64 KB of tightly coupled memory, DSP support for single cycle 32-bit MAC, single instruction multiple data extensions and single-precision floating-point unit
- Up to 64-channel DMA for peripheral and memory servicing with reduced CPU loading and faster system throughput
- Crossbar switch enables concurrent multi-master bus accesses, increasing bus bandwidth

Timing and Control

- Four FlexTimers with a total of 20 channels. Hardware dead-time insertion and quadrature decoding for motor control.
- Four-channel 32-bit periodic interrupt timer provides time base for RTOS task scheduler or trigger source for ADC conversion and programmable delay block

HMI

- TFT LCD displays capable of up to XGA resolution

For more information, please visit freescale.com/VF6xx.



Design Resources

Freescale Enablement Solutions

Tower System development platform	37	i.MX applications processor software solutions	48
Freedom development platform	39	Kinetis development tools	49
MQX software solutions	40	Kinetis Design Studio IDE	50
Processor Expert software	44	Embedded Board Solutions.	80
PEG graphics software	45		
i.MX development tools	47		



Freescale Connect Partner Enablement Solutions

<i>Premier Partner</i> ARM	51	Embest	64	Motomic Software	72
<i>Premier Partner</i> Adeneo Embedded.	52	Emcraft Systems	64	MSC Technologies GmbH	72
<i>Premier Partner</i> Enea	53	Emtrion	65	NetModule	72
<i>Premier Partner</i> Green Hills Software	54	Engicam	65	Nexcom	72
<i>Premier Partner</i> IAR Systems	55	eSOL Co., Ltd.	65	NovTech	73
<i>Premier Partner</i> Mentor Graphics	56	F&S Elektronik	65	Open Synergy	73
<i>Premier Partner</i> QNX Software Systems	57	FirstView	66	O.S. Systems	73
<i>Premier Partner</i> Wind River	58	FreeRTOS	66	P&E Microcomputer Systems	73
Ac6	59	FriskyDSP Technology Ltd.	66	Pelagicore	74
Advantech	59	G5 Engineering Solutions	66	PHYTEC	74
AllGo Embedded Systems	59	GainSpan	67	Prevas Technologies	74
Altia Incorporated	59	Garz & Fricke	67	ProMik	74
Analogue & Micro Ltd.	60	Gateworks Corp.	67	RealVNC	75
Arcturus	60	HandsOn-Training	67	rt-labs	75
Asset Intertech	60	HILFI GmbH	68	Rightware	75
Atollic	60	Infobank Corporation	68	San Juan Software	75
Au-Zone Technologies, Inc.	61	iSYSTEM	68	SECO	76
BCM Advanced Research	61	iWave Systems	68	SEGGGER	76
Bluetechnix	61	Ka-Ro	69	Silex Technology	76
Borea	61	Kontron	69	Sohwa & Sophia Technologies	76
Boundary Devices	62	Kozio	69	Symphony Teleca Corporation	77
CompuLab	62	Lauterbach	69	SYSGO	77
Cosmic	62	Linear Technology	70	TechNexion	77
Crank Software	62	Linux4biz	70	Timesys	77
Cybercom	63	Logic PD	70	Toradex	78
Develco A/S	63	M2CoreTech	70	TQ-Components	78
Digi International	63	Micrium	71	Ubiquitous Corporation	78
Elektrobit	63	Microgenios	71	Variscite	78
Embedded Access, Inc.	64	Micron Technology	71	Vector Informatik	79
Embedded Labworks	64	MicroSys	71	(Guangzhou) ZLG MCU Technology Co, Ltd.	79

Freescale Enablement Solutions

Software and development solutions

Freescale Tower System

The Freescale Tower System is a modular development platform for 8-, 16- and 32-bit MCUs and MPUs that enables advanced development through rapid prototyping. Featuring multiple development boards or modules, the Tower System provides designers with building blocks for entry-level to advanced development.

Modular and Expandable

- Controller modules provide easy-to-use, reconfigurable hardware
- Interchangeable peripheral modules (including communications, memory and graphical LCD) make customization easy
- Open-source hardware and standardized specifications promote the development of additional modules for added functionality and customization

Speeds Development Time

- Open source hardware and software allows quick development with proven designs
- Integrated debugging interface allows for easy programming and run control via standard USB cable

Cost Effective

- Interchangeable peripheral modules can be reused with all Tower System controller modules, eliminating the need to purchase redundant hardware for future designs
- Enabling technologies like LCD, Wi-Fi, motor control, serial and memory interfacing are offered off-the-shelf at a low cost to provide a customized enablement solution

Take Your Design to the Next Level

For a complete list of development kits and modules offered as part of the Freescale Tower System, please visit freescale.com/Tower.

The Freescale Tower System development platform

Controller/Processor Module (MCU/MPU)

- Tower MCU/MPU board
- Works stand-alone or in Tower System
- Features integrated debugging interface for easy programming and run control via standard USB cable

Secondary Elevator

- Additional and secondary serial and expansion bus signals
- Standardized signal assignments
- Mounting holes and expansion connectors for side-mounting peripheral

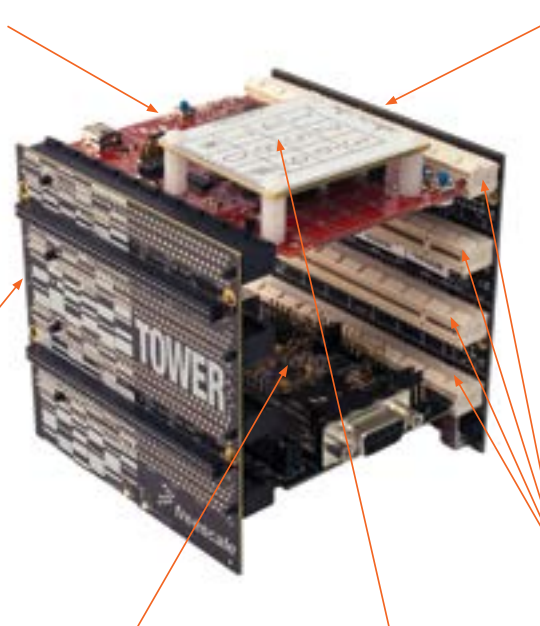

Primary Elevator

- Common serial and expansion bus signals
- Two 2 x 80 connectors on back side for easy signal access and side-mounting board (LCD module)
- Power regulation circuitry
- Standardized signal assignments
- Mounting holes

Size

- Fully assembled Tower System is approx. 3.5" H x 3.5" W x 3.5" D

Board Connectors

- Four card-edge connectors
- Uses PCI Express connectors (x16, 90 mm/3.5" long, 164 pins)

Peripheral Module

- Adds features and functionality to your designs
- Interchangeable with other peripheral modules and compatible with all controller/processor modules
- Examples include serial interface, memory, Wi-Fi, graphical LCD, motor control, audio, Xtrinsic-sensing and high-precision analog modules

Tower Plug-In (TWRPI)

- Designed to attach to modules that have a TWRPI socket(s)
- Adds features and functionality
- Swappable with other TWRPIs
- Examples include accelerometers, key pads, touchpads, sliders and rotary touchpads

Tower System Boards

Controller/Processor Modules (8-, 16-, 32-bit)		freescale.com/TowerController
Works standalone or as part of Tower System		Allows rapid prototyping
Features open source debugging interface		Provides easy programming and run control via standard USB cable
Peripheral Modules		freescale.com/TowerPeripheral
Can be reused with all Tower System controller modules		Eliminates the need to buy/develop redundant hardware
Interchangeable peripheral modules: Serial, memory, graphical LCD, prototyping, sensor		Enables advanced development and broad functionality
Tower Plug-Ins		freescale.com/TWRPI
Designed to attach to any Tower System module with a TWRPI socket(s)		Adds features and functionality with little investment
Swappable components		Allows for design flexibility
Elevator Modules		freescale.com/TowerELEV
Two 2 x 80 connectors		Provides easy signal access and side-mounting board (i.e., LCD module)
Power regulation circuitry		Provides power to all boards
Standardized signal assignments		Allows for customized peripheral module development
Four card-edge connectors available		Allows easy expansion using PCI Express connectors (x16, 90 mm/3.5" long, 164 pins)

Partner Modules

Tap into a powerful ecosystem of Freescale technology alliances for building smarter, better connected solutions. Designed to help you shorten your design cycle and get your products to market faster, these technology alliances provide you with access to rich design tools, peripherals and world-class support and training. To learn more, visit freescale.com/partners.

Interested in designing your own Tower System compatible module? Visit freescale.com/tower/specialist to learn more.



Tower Geeks Online Community

TowerGeeks.org is an online design engineer community that allows members to interact, develop designs and share ideas. Offering a direct path to explore and interact with other engineers designing with the Tower System, **TowerGeeks.org** is a great way to discuss your projects, post videos of your progress, ask questions through the forum and upload software. With updates through Twitter and Facebook, it's easy to get involved.



Follow Tower Geeks on Twitter
twitter.com/towergeeks



Visit Freescale on Facebook
facebook.com/freescale

Freescale Freedom Development Platform

Overview

The Freescale Freedom development platform offers small, low-power, cost-effective evaluation and development boards for quick application prototyping and demonstration of Kinetis MCU families.

Each board offers an easy-to-use mass-storage device mode flash programmer, virtual serial port and classic programming and run-control capabilities.

It's easy to get started. Simply choose your preferred Freescale Freedom development hardware, select compatible software, connect with the community and go.

Features

- Small size (approximately 3.25" x 2"), fits within a mint tin
- Arduino footprint-compatible with support for a rich set of third-party expansion boards ("shields")
- Easy access to the MCU I/O pins
- Integrated open-standard serial and debug adapter (OpenSDA) with support for several industry-standard debug interfaces

Software Enablement and Support

- Rich ARM ecosystem includes Keil, IAR, SEGGER, CodeWarrior, mbed and more
- Freescale MQX Lite RTOS: Very light MQX kernel for resource-limited MCUs that allows applications to run with less than 4 KB RAM
- Processor Expert software and embedded components
- A number of Freedom development boards are mbed-enabled through the built-in USB flash programming interface (OpenSDA). Simply plug it in, drop on an "mbed interface" program binary and it's up and running

Example: FRDM-KL25Z Freedom Development Platform

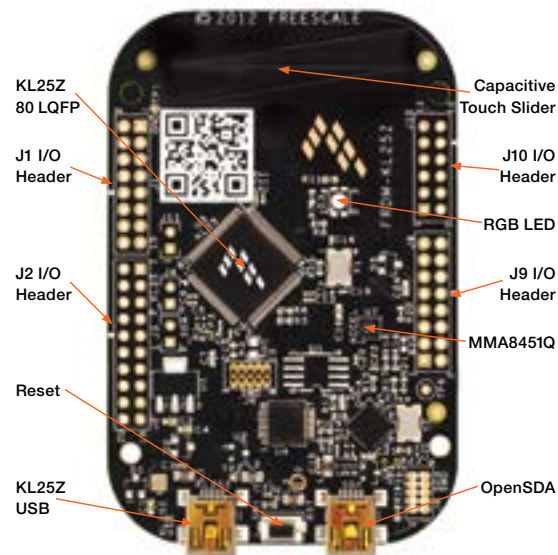

OpenSDA: Open-Standard Serial and Debug Adapter

The integrated debug circuit, OpenSDA, bridges serial and debug communications between a USB host and an embedded target processor. OpenSDA features a mass storage device bootloader that provides a quick and easy mechanism for loading different OpenSDA applications such as flash programmers, run-control debug interfaces, serial-to-USB converters and more, including:

- Freescale mass storage device flash programming interface eliminates tool installation for quick evaluation of demonstration applications
- P&E Multilink interface provides run-control debugging and compatibility with IDE tools
- SEGGER OpenSDA firmware makes OpenSDA compatible to J-Link Lite
- mbed interface application provides connection to mbed online tools and supports a virtual serial port, CMSIS-DAP, and a mass-storage programming interface
- CMSIS-DAP interface (standalone): New ARM standard for embedded debug interface

Get Started

Learn more at freescale.com/freedom.

Get your Freedom hardware mbed-enabled from mbed.org.

Enable your OpenSDA as a SEGGER J-Link Lite at segger.com/opensda.html.

For a complete list of boards offered as part of the Freescale Freedom development platform, please visit freescale.com/Freedom.



Freescale MQX Software Solutions

Overview

The increasing complexity of industrial applications and expanding functionality of semiconductors are driving embedded developers toward solutions that combine proven hardware and software platforms. To help accelerate time to market and improve application development success, we offer the MQX real-time operating system (RTOS) with TCP/IP (IPv4) and USB software stacks and peripheral drivers to Kinetis, Vybrid, select ColdFire, and select Power Architecture MCUs customers at no additional charge. The combination of Freescale MQX software solutions with our silicon portfolio creates a comprehensive source for hardware, software, tools and services.

Reducing Cost, Accelerating Success

Providing complimentary Freescale MQX software solutions with our silicon products helps to alleviate much of the initial software investment hurdle faced by embedded developers. Comparable full-featured software offerings may cost developers as much as \$95,000 (USD) in licensing fees.

Freescale MQX is deployed as production-ready source code, including communications software stacks and peripheral drivers, at no additional cost. Freescale MQX is provided with a commercial-friendly software licensing model, enabling developers to keep their source modifications while being able to distribute the required binary code.

Full Featured, Proven and Scalable

The Freescale MQX RTOS offers powerful, preemptive real-time performance with optimized context switch and interrupt time to enable fast, highly predictable response times. Its small, configurable size conserves memory space for embedded applications and it can be configured to take as little as 6 KB of ROM, including kernel, interrupts, semaphores, queues and memory manager. The Freescale MQX RTOS offers a straightforward application programming interface with a modular, component-based architecture that makes it very scalable. Components are linked in only if needed, preventing unused functions from bloating the memory footprint. Plug-ins, such as security, industrial protocols and graphical interfaces from our strong network of partners, can also be added.

Comprehensive Freescale Solution

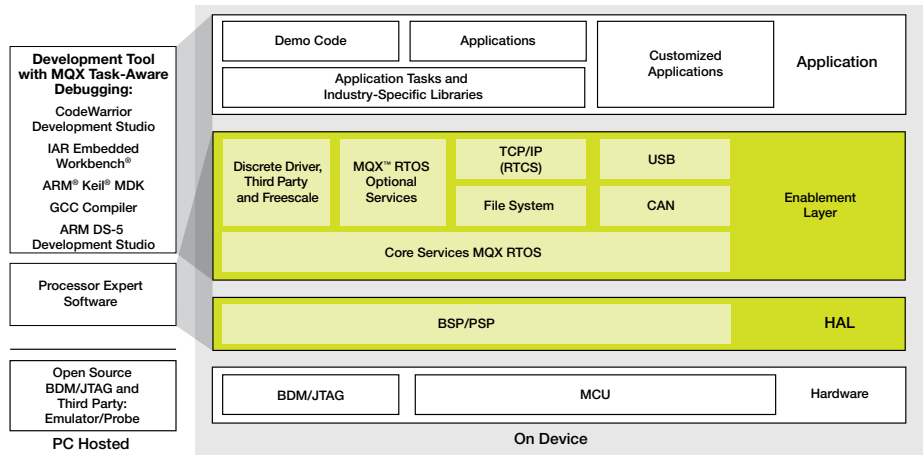

■ Freescale MQX Software Solutions

MQX RTOS: Customizable Component Set

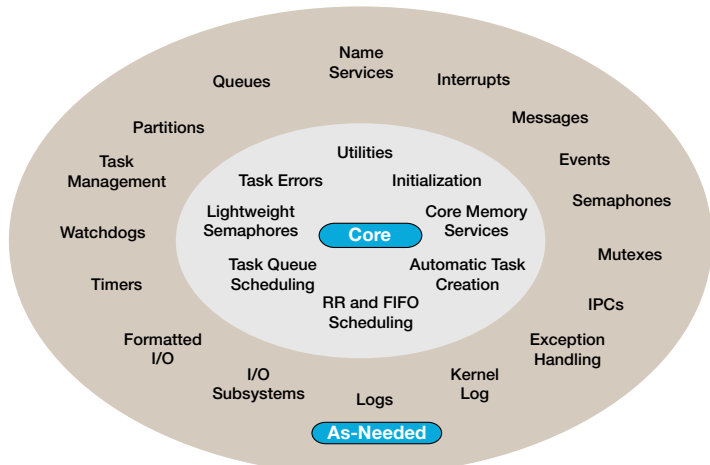

MQX Real-Time TCP/IP Communication Suite

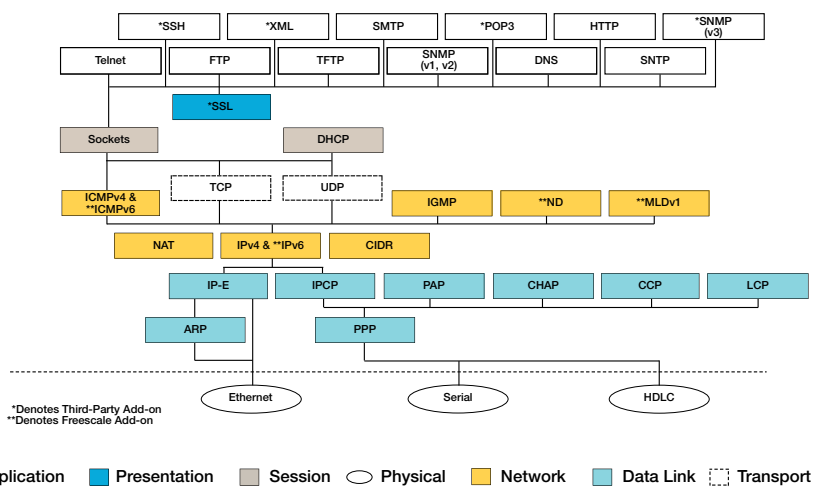

Freescale MQX Real-Time TCP/IP Communication Suite

The Freescale MQX real-time communication suite (RTCS) is a fast, efficient and low-footprint embedded Internet stack that supports a rich set of standard TCP/IP protocols. It comes complete with a number of application layer protocols such as Telnet, FTP, SNMP v1 and SNMP v2. A number of optional protocols and products are also available from Freescale or third parties. The scalability of the Freescale MQX RTCS allows developers to easily define the feature set needed to accommodate a variety of ROM and RAM memory budgets.

IPv6 Ready

Get ready for IPv6 with the IPv6 protocol add-on for MQX RTCS. With this new optional add-on available for purchase from Freescale, the network stack can be configured for IPv4 only, IPv6 only, or dual (IPv4 + IPv6) operation. With dual IPv4 + IPv6 operation, embedded products will be ready for the worldwide transition to the next generation of the Internet (IPv6), but retain support for the Internet of today (IPv4).

Features and Benefits

Freescale MQX RTOS

Small code density	<ul style="list-style-type: none"> Context switch and low-level interrupt routines hand-optimized in assembly Can be configured to a memory footprint of 8 KB ROM and 2.5 K RAM on ARM Cortex-M4, including kernel, task applications, LW semaphore, interrupt stack, queues and memory manager
Component-based architecture	<ul style="list-style-type: none"> 25 components—eight core, 17 optional Components are linked in only if needed, preventing unused functions from bloating the memory footprint
Full and lite services	<ul style="list-style-type: none"> Further control of size, RAM/ROM utilization and performance options
Real-time, priority-based preemptive multithreading	<ul style="list-style-type: none"> Threads execute in order of priority Allows high-priority threads to meet their deadlines consistently, no matter how many other threads are competing for CPU time
Optimized for Freescale	<ul style="list-style-type: none"> Optimized assembly code to accelerate key real-time portions of the RTOS such as context switching
Faster development	<ul style="list-style-type: none"> Allows for faster development time by relieving engineers from creating an efficient scheduling system and interrupt handling Use of multiple communication protocols such as USB or TCP/IP
Code reuse	<ul style="list-style-type: none"> Provides a framework with a simple API to build and organize the features across our broad portfolio of embedded processors
Intuitive API	<ul style="list-style-type: none"> Writing code for MQX is straightforward with a complete API and available reference documentation
Fast boot sequence	<ul style="list-style-type: none"> Ensures the application is running fast after the hardware has been reset
Simple message passing between processors	<ul style="list-style-type: none"> Messages can be either from a system/private pool and sent with either an urgent status or a user-defined priority and can be broadcast or task specific For maximum flexibility, a receiving task can be operating on either the same CPU as the sending task or on a different CPU within the same system

Freescale MQX RTCS

Designed for embedded applications	<ul style="list-style-type: none"> Specifically designed for embedded systems Provides fully compliant feature set of networking stacks and configurable enough to fit into the small memory confines of an embedded devices Tightly integrated with Freescale MQX RTOS device drivers for Ethernet and other access layers
Small configurable memory footprint	<ul style="list-style-type: none"> Implemented as a C library Allows only the features and protocols used by the application to be included in the image Can be configured to take as little as 30 KB of ROM
RTCS protocol support	<ul style="list-style-type: none"> Provided with a large number of standard protocols One product allows real TCP/IP applications without the need to acquire other application-level protocols
IPv6 Ready	<ul style="list-style-type: none"> Optional add-on for IPv6 protocol support Can operate as a Dual IPv4 + IPv6 network stack, or IPv4 only, or IPv6 only IPv6 support can be added with as little as 21 KB of additional ROM code
Advanced networking protocols for RTCS	<ul style="list-style-type: none"> RTCS can be extended to support additional industry-standard protocols, including security, advanced routing/network access, embedded Web server/ email support and network management protocols
Very scalable	<ul style="list-style-type: none"> Customizable suite can meet a wide range of application RAM and ROM requirements by selectively choosing only the necessary protocols for your design
Full featured	<ul style="list-style-type: none"> Great flexibility in the way you provide connectivity to your device, ranging from simple application such as Ethernet-Serial to complex gateway systems
Support for standard protocols and sockets	<ul style="list-style-type: none"> RTCS not only provides application layer protocols but is a complete OSI model solution that spans data link to application layer standard protocols

Freescale MQX File System

Designed for embedded applications	<ul style="list-style-type: none"> Provides full MS-DOS compatible file system that is configurable to fit into small memory footprint Brings support for desktop PC features such as long file names, multiple disk volumes and directory handling to embedded systems
Portability and modularity	<ul style="list-style-type: none"> The MFS FAT file system provides a portable, compatible implementation of the MS-DOS file system and library of file system functions File system functions are separated from the device driver functions, allowing for increased modularity Supports different types of storage media Trivial file system is a simple read only file system used to avoid the need of MFS in HTTP

Freescale MQX USB Host/Device Stack

Designed for embedded applications	<ul style="list-style-type: none"> Specifically designed for adding USB functionality to embedded systems Provides fully compliant USB 1.1 and 2.0 feature set of stacks and drivers
Small configurable memory footprint	<ul style="list-style-type: none"> Designed to fit in a small (<10 KB RAM) and with code size of <32 KB
Supports a variety of class functionality	<ul style="list-style-type: none"> Supports personal health care device class (PHDC), human-interface device (HID), mass storage device (MSD), communications device class (CDC), audio class, On-The-Go USB 2.0 standard supplement and PHDC USB.org standard classes

MQX Lite RTOS

Freescale MQX Lite RTOS is a very light MQX kernel for resource-limited MCUs. Initially targeted at the Kinetis L family, applications can run with less than 4 KB RAM. It is a true subset of the proven and professionally developed MQX RTOS, allowing for easy upward code migration. It is easily configurable within the Processor Expert software MCU driver suite to be used with the tool chain of your choice. In addition, you can take advantage of all of the drivers supported in Processor Expert software to ease scalability from one MCU to another.

Availability

MQX Lite RTOS is available as a component within the following Freescale software offerings:

- Processor Expert software, MCU driver suite: Supports IAR, Keil and GCC compilers/build chains
- CodeWarrior Development Studio V10.3 and later

MQX Lite RTOS Functionality

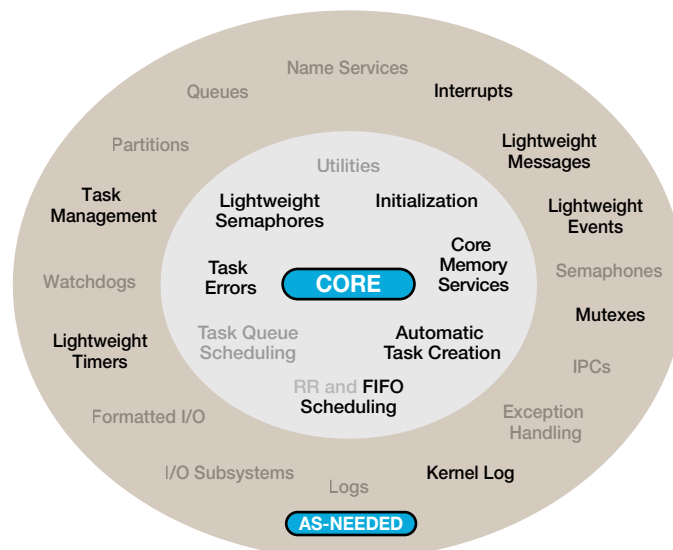

MQX Lite RTOS Features and Benefits

Easy to configure	<ul style="list-style-type: none"> • Packaged as a Processor Expert component • Configurable options: Set name of task function, priority, stack size (all the same parameters as an MQX task)
Easy to add to existing application	<ul style="list-style-type: none"> • Just drop in the MQX Lite RTOS component • Get started in minutes
Very lightweight	<ul style="list-style-type: none"> • Minimal app ("Hello" task, idle task, interrupt stack), less than 4 KB RAM • Optimized for resource-limited MCUs like Kinetis L family
I/O capability provided by Processor Expert software	<ul style="list-style-type: none"> • Take advantage of the broad spectrum of MCU logical device drivers • Access libraries/stacks such as the USB Processor Expert component
Real-time, priority-based preemptive task switching	<ul style="list-style-type: none"> • Threads execute in order of priority • Allows high-priority threads to meet their deadlines consistently, no matter how many other threads are competing for CPU time
Programming model allows upward code migration	<ul style="list-style-type: none"> • MQX Lite RTOS is a true subset of the full MQX RTOS • Code built with MQX Lite RTOS will easily move to the full MQX RTOS

Freescal MQX RTOS for Kinetis SDK

Built on top of the software development kit (SDK) for Kinetis MCUs, the Freescale MQX RTOS for Kinetis SDK provides the essential extensions of the Kinetis SDK framework for connected and intelligent embedded products.

Freescal MQX RTOS for Kinetis SDK leverages the flexible and extendable peripheral drivers found within the Kinetis SDK. Application developers can use standard MQX RTOS components such as the multi-tasking scheduler, communication stacks, and file system with Kinetis SDK libraries and peripheral drivers.

Features

- All the components of MQX Software Solutions available pre-integrated and tested with the Kinetis Software Development Kit (SDK):
 - MQX RTOS
 - MQX Real-Time TCP/IP Communication Suite
 - MQX File System
 - MQX USB Host/Device Stack
- Same API as traditional MQX RTOS kernel and services
- I/O capability provided by Kinetis SDK peripheral drivers
- Builds on common software framework for Kinetis MCUs to enhance flexibility and extendibility
- Publically available beta software with planned updates coming in Q4 of 2014.

Learn more at freescale.com/mqx/ksdk.

MQX Version Comparison

	MQX RTOS 4.0	MQX Lite RTOS	MQX RTOS for Kinetis SDK
Delivery Mechanism	Traditional installer with full source	Processor Expert (PEX) component	Archive file with full source and PEX components
I/O Drivers	MQX peripheral drivers; PEX driver optional	PEX drivers only	Kinetis SDK drivers
Configurability	User selects needed services from full or lightweight versions	Reduced services available, lightweight options only	User selects needed services from full or lightweight versions
Components	Kernel, TCP/IP stack, USB stack, file system, middleware. Includes own peripheral drivers.	Kernel only. Peripheral drivers provided by PEX.	Kernel, TCP/IP stack, USB stack, file system, middleware. Peripheral drivers provided by Kinetis SDK.
Availability	Kinetis K Series, Vybrid, select ColdFire, select Power Architecture	Kinetis L Series, Kinetis K Series, select Kinetis E Series	All Kinetis MCUs supported by Kinetis SDK

MQX Support Options

MQX RTOS Support

Freescal offers a range of MQX RTOS support options based on your design needs. Whether you are just getting started with MQX RTOS or are deep into your development project, it's easy to get the support you need, when you need it.

Learn more at freescale.com/

MQX/support.

Professional Engineering Services

Engineering services are also available through Freescal and include software development services and on-site support and training services. Engineering service requests are individually evaluated on a first-come-first-served and project scope basis. To request Freescal MQX engineering services, please contact your local Freescal sales or FAE resources.

Learn more at freescale.com/engservices.

Processor Expert Software

Processor Expert is a rapid application design tool that combines easy-to-use component-based application creation with an expert knowledge system.

- CPU, on-chip peripherals, external peripherals and software functionality are encapsulated into embedded components.
- Each component's functionality can be tailored to fit application requirements by modifying the component's properties, methods and events.
- When the project is built, Processor Expert automatically generates highly optimized embedded C code.

Processor Expert software is integrated in Eclipse and can be used both with Eclipse or with non-Eclipse users for all the supported platforms. It nicely integrates into the Eclipse or external IDEs and takes advantage of the Eclipse framework and ecosystem with version control, automatic documentation and advanced editing functionality.

The Processor Expert Knowledge Base incorporates all the information from the data sheets: It knows everything about pin muxing, clock and interrupt configuration, hardware and peripheral capabilities, and offers a convenient graphical user interface to configure it. Processor Expert checks the consistency of the MCU configuration settings and flags errors that otherwise are hard to find. Using Processor Expert helps get you started with a new design in minutes, and there is no need to read thousands of reference manual pages first.

Processor Expert includes the Component Development Environment (CDE). With this, you do not have to accept generic one-size-fits-all drivers. You can design custom peripheral drivers ideally suited to your needs, without having to know everything about the hardware. A wizard guides you through creating software components that you can use and distribute to bring software development and engineering to the next level.

Features	Benefits
Graphical User Interface	<ul style="list-style-type: none"> • Allows an application to be specified by the functionality needed • Eclipse framework with multiple detachable views, multimonitor support and highly configurable look and feel
Embedded Components	<ul style="list-style-type: none"> • Components and drivers for on-chip peripherals (BitIO, SCI, CAN, USB, Timers, LCD, etc.) • Bare metal (no RTOS) and RTOS aware, including MQX • Additional components can be created or downloaded and added to the system, e.g. FreeRTOS or off-chip devices (EEPROM, transceivers, LCD displays, etc.)
Automatic Code and Documentation Generator	<ul style="list-style-type: none"> • Creates tested, optimized C code tuned to application needs and the selected Freescale device • Automatically generates text and open source doxygen documentation for HTML or PDF formats • Static code generation so generated drivers can be used without the need for Processor Expert in projects
Built-In Knowledge Base	<ul style="list-style-type: none"> • No need to read the data sheet: Processor Expert knows the pins available, which pins can be used in which mode and what settings are possible • Generates tested and working code sequences for the most complicated peripheral usage: configuring the MCU clocks is just a matter of a few clicks • Direct access to low-level MCU registers and functionality using highly optimized PDD macros • Immediately flags resource conflicts and incorrect settings so errors are caught early in the design cycle
Component Development Environment	<ul style="list-style-type: none"> • Allows user-specific hardware-independent embedded components to be created • Graphical user interface with wizard to assist software driver code and component generation • Components and driver code sharable with other developers

Processor Expert Software: Microcontroller Driver Suite

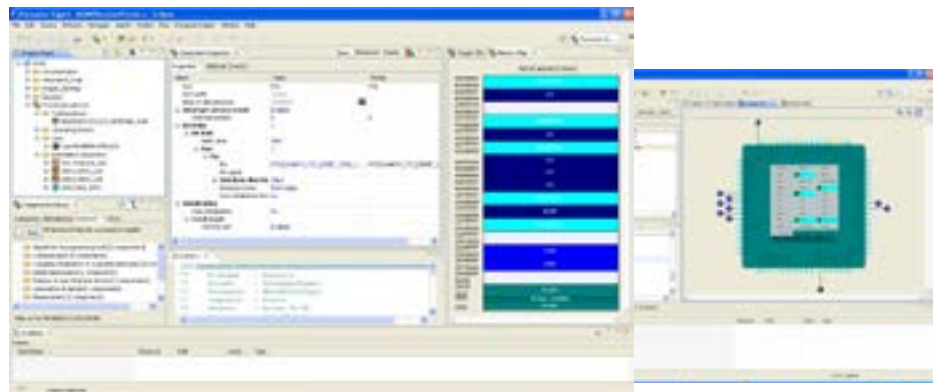

PEG Graphics Software

Freescale provides graphical user interface (GUI) solutions for embedded devices.

Freescale's PEG Pro, PEG Plus and PEG Lite product offering includes a GUI library for embedded development that works elegantly with real-time operating systems. The graphical development solution tool allows developers to lay out user interface screens and controls using the PEG library and external resources to generate C++ code.

The PEG product family is designed to meet widely varying power, performance and memory requirements, helping to:

- Reduce product development risk
- Lower in-house development costs
- Accelerate time to market

PEG software accelerates GUI design for embedded devices by allowing developers to create prototypes on a Windows- or Linux-based PC by providing a complete visual layout and design tool to enable GUI design to take place in parallel to the embedded software/hardware development.

The PEG WindowBuilder automatically generates C++ source code that is ready to be compiled and linked into any application, further accelerating the deployment of the final product.

Freescale's PEG graphic solutions work hand in hand with real-time operating systems to incorporate LCD screens and display interfaces into future products. The GUI development tools address a variety of embedded systems, including consumer electronics, industrial, medical and communications markets.

PEG Graphics Software

PEG Lite	PEG Plus	PEG Pro
<ul style="list-style-type: none"> • Free source-code license on Freescale silicon • Up to 16-bit color • Very small footprint • Basic widgets • Dual-language capable 	<ul style="list-style-type: none"> • Multiple window updates • Alpha-blended images • Runtime image decoders and language resources • Custom widget integration • Dynamic themes • Multi-language capable 	<ul style="list-style-type: none"> • Screen transitions • Blending of transparent images and windows • True anti-aliasing • Gradient manager • Transparent text with drop shadow effects
One of the smallest footprints and most efficient code bases available		
Starting at 42 KB Typical 42–52 KB	Starting at 48 KB Typical 48–72 KB	Starting at 64 KB Typical 64–96 KB
The Professional Services Team provides custom consulting and software development: driver development, UI development and graphic design.		

GUI Interface—Three Basic Drivers

LCD Driver

- The LCD driver interfaces between the PEG Library and the LCD panel either through an onboard or external controller.

RTOS Driver

- The driver interfaces between the PEG library and the RTOS installed on the MPU. If an RTOS has not been selected, use the standalone driver to jump-start your development process.

Input Drivers

- Inputs drivers available in multiple forms, including, but not limited to, a touchscreen, keypad or from other sources within the system, including support of Freescale touch solutions.

PEG software also provides custom drivers for most LCD panels and controllers, RTOS systems, touch screens and other input devices.

PEG's modular form enables a rapid development process.

- The core library interfaces to different RTOSes, input devices and LCD controllers by replacing the underlying drivers.

PEG Window Builder for Rapid Development

WindowBuilder allows a designer to layout each of the screens for a project through a simple-to-use interface, providing a “What You See is What You Get (WYSIWYG)” display.

- Full WYSIWYG development
 - Simulation environment for PEG Lite, PEG Plus and PEG Pro
 - Runs on PC/Linux/X11 to allow proof of concept development
 - Enables hardware/software development to happen in parallel
 - Made available for free evaluation

Benefits

- Reduce development time and costs
- Rapid user interface development
- Resolve product usability issues before committing to a physical design
- Standardize on graphics software solutions across products
- Differentiate your product with a sophisticated user experience
- Flexibility in selecting the processor/graphics controller

Features

- Highly customizable, small footprint for cost-sensitive applications
- Multilingual support, including Unicode
- High color, including true anti-alias line and font drawing support and per-pixel alpha blending
- Designed for cross platform application development, highly portable across OS and CPUs
- Screen transition effects: slide-in, wipe and fade
- Touchscreen support
- Support for multiple graphics layers
- Runtime “theme” support
- Button, sliders, scrolling text, dials, progress bars, multiline text box and spreadsheet
- Integrated font creation and image conversion utilities

Target Applications

Appliance	Consumer	General Purpose	Medical	Factory Automation
<ul style="list-style-type: none"> • Human-machine interface • Small home appliances • Large appliances 	<ul style="list-style-type: none"> • Digital TV and set-top box applications • Handheld GPS units • Printers • Smart phones • Digital cameras 	<ul style="list-style-type: none"> • Connected multimedia devices • Automotive infotainment • Home security systems • Test and measurement devices • POS kiosks 	<ul style="list-style-type: none"> • Blood glucose monitors • Electro-cardiogram • Ventilators • Patient monitors • Defibrillators 	<ul style="list-style-type: none"> • Industrial automation • Human-machine interface

PEG Graphics Software: Runtime for flexible GUI Framework

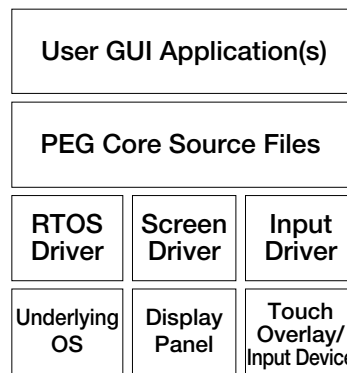

- Portable GUI application layer
- Full access to PEG source code
- RTOS Integration Driver
- Bare metal
- MQX or other RTOS
- Linux
- Configurable Screen Driver
- Integrated LCD Controllers and Smart Display Panels
- Range of color depth options
- Flexible Input Driver
- Analog and Digital interfaces to input devices
- Polling or message driven communication

Supported Ecosystem and Partners

RTOS

- Freescale MQX
- Mentor Graphics® Nucleus®
- Express Logic ThreadX®
- Green Hills INTEGRITY
- Keil RTX, ARTX
- Micrium µC/OS-II
- Micro Digital SMX®
- Can be integrated with any RTOS

Hardware

- Freescale ColdFire and Kinetis MCUs, i.MX processors and Power Architecture processors
- All ARM cores, including NXP and Samsung
- Can be supported for any vendor silicon

Free Evaluation—freescale.com/peg

For other licensing options, please contact pegsales@freescale.com or 1-810-385-2893.

Pricing subject to change. For current pricing contact a sales representative.

i.MX Development Tools

i.MX Community

Take your designs to the next level, reduce your design complexity and accelerate your time to market with i.MX development boards and solutions. Our i.MX development boards support a broad portfolio of products, include readily available design files and are supported by a rich ecosystem and community of developers at imxcommunity.org.

SABRE: Smart Application Blueprint for Rapid Engineering

Accelerate your time to market with the Smart Application Blueprint for Rapid Engineering (SABRE) series of market-focused development systems based on the i.MX family of multimedia applications processors. SABRE platforms deliver the advanced technology features required for your market's next-generation applications, including tablets, e-readers and automotive infotainment systems. From hardware accelerators and multimedia codecs to an expansive portfolio of software development tools including board support packages (BSPs), SABRE platforms come highly optimized with the best offerings from Freescale and our technology partners so you can maximize the performance and power savings features of the processor in your design.

SABRE Reference Designs SABRE Board for Smart Devices

The SABRE board for smart devices introduces developers to quad-core processing and bleeding-edge multimedia and graphics applications on the i.MX 6Quad processor. Developers are able to work with the majority of the i.MX 6Quad processor's primary features while remaining schematically compatible with their i.MX 6Quad, i.MX 6Dual, i.MX 6DualLite and i.MX 6Solo designs. The SABRE board for smart devices includes complete hardware design files, BSP for Android, Linux and Windows Embedded (via third party) and a bootable SD card containing an Android BSP image. More information is available at freescale.com/SABRESDB.

SABRE Board and Platform for Smart Devices Based on the i.MX 6 Series—Features

SABRE Board for Smart Devices

- i.MX 6Quad 1 GHz CPU
- Memory
 - 1 GB DDR3
 - 8 GB eMMC flash
- Display options
 - HDMI connector
 - 2x LVDS connectors
 - LCD expansion port connector (parallel, 24-bit)
- Audio features
 - Stereo audio codec
 - 2x 3.5 mm audio ports (stereo headphone and microphone)
- Connectivity and storage
 - 2x full-size SD/MMC card slots
 - mPCIe connector
 - SATA 22-pin connector
 - 10/100/1000 Ethernet connector
 - USB OTG connector
 - 1x micro USB connector
- Other
 - 20-pin JTAG connector
 - Sensors: accelerometer, compass
 - Expansion connector: MIPI CSI, I²C, SSI, SPI
 - Power management IC: Freescale PF Series 101

Red indicates change from column to the left

SABRE Platform for Smart Devices

The SABRE platform for smart devices is based on the i.MX 6Quad and i.MX 6DualLite processor families and can be targeted toward any device requiring an intelligent display, connectivity, low power and amazing user experience. It provides a foundation for enabling new product designs in markets such as portable computing, education, industrial, digital displays, medical and home automation. The SABRE platform for smart devices includes complete hardware design files, BSP for Android and Linux, and a bootable SD card containing an Android BSP image. BSP configuration options allow for the evaluation of the pin compatible i.MX 6Dual and i.MX 6Solo processor families. More information is available at freescale.com/SABRESDB.

SABRE Platform for Smart Devices

- i.MX 6Quad 1 GHz or i.MX 6DualLite 1 GHz CPU
- Memory
 - 1 GB DDR3
 - 8 GB eMMC flash
 - 4 MB SPI Nor flash
- Display options
 - HDMI connector
 - 10" WXGA LVDS panel with capacitive touch
 - 1x LVDS connector
 - LCD expansion port connector (parallel, 24-bit)
 - EPDC expansion port connector (i.MX 6DualLite)
- Audio features
 - Stereo audio codec
 - 2x 3.5 mm audio ports (stereo headphone and microphone)
 - 2x board mounted digital microphones
- Connectivity and storage
 - 2x full-size SD/MMC card slots
 - mPCIe connector
 - SATA 22-pin connector (i.MX 6Quad)
 - 10/100/1000 Ethernet connector
 - USB OTG connector
 - 1x micro USB connector
 - GPS module with antenna
- Other
 - 20-pin JTAG connector
 - 2x 5 MP cameras
 - Sensors: accelerometer, compass, ambient light sensor
 - Expansion Connector: MIPI CSI, I²C, SSI, SPI
 - Power management IC: Freescale PF Series 101

i.MX Evaluation Kits (EVKs)

Our EVKs offer developers a cost-effective platform to develop, debug and demonstrate their next great product without compromising performance. EVKs support the features of the device in a small, single-board design with optional add-on modules to enable developers with a complete development platform. A range of peripheral and connectivity options makes the EVK suitable for developing a wide range of consumer, industrial and automotive applications.

i.MX28 evaluation kit:

freescale.com/iMX28evk

i.MX50 evaluation kit:

freescale.com/iMX50evk

i.MX53 quick start board:

freescale.com/iMX53QSB

i.MX 6SoloLite evaluation kit:

freescale.com/6SLevk

i.MX Applications Processor Software Solutions

Our i.MX portfolio is provided with highly optimized BSPs, multimedia codecs and middleware to shorten product development and speed time to market all while maximizing the capabilities of the i.MX series feature sets.

Android

Freescale supports the Android OS through BSPs for the i.MX range of application processors and featured tools such as the SABRE platform for smart devices, based on the i.MX 6Quad and i.MX 6DualLite processor families.

Using a layered approach with the right selection of components to interface into the Android stack results in a more complete and ready solution. Designers can directly develop applications on this integrated solution or easily modify their own drivers based on our reference code.

The i.MX family of applications processors running Android OS is an excellent platform for building a high-performance, low-power and cost-effective mobile device.

Features

- Integrated and tested Android framework with optimized codecs, graphics and a development and debug environment
- Common code base across i.MX SoCs to greatly reduce porting effort to next-generation i.MX processors
- Source code for selected drivers and middleware
- Source code for unit tests
- Toolchain included with the BSP
- Documentation (e.g., reference manual, user guide, release notes)



For more information, visit freescale.com/iMXAndroid.

Linux

Quickly get your Linux-based designs started with the i.MX family of processors by using our Linux development tools. Our goal is to provide you with a comprehensive Linux environment that is easy to develop your designs and reduce your time to market.

Linux board support packages (BSPs) are tested and certified ensuring a fully operational toolchain, kernel and board-specific modules that are ready to use together within a fixed configuration for i.MX hardware development tools. These BSPs provide the foundation you need to begin your project quickly.

Features

- Linux kernel and device drivers
- Applications/services
- Libraries
- GNU tools (e.g., compilers, linkers, etc.)
- Deployment mechanisms



For more information, visit freescale.com/iMXLinux.

Microsoft

Windows Embedded Compact BSPs for i.MX applications processors are available through Freescale's wide ecosystem of partners and include offerings such as Windows Compact 7 and Windows Compact 2013.



For more information, visit freescale.com/iMXWindowsEmbedded.

i.MX High-Performance Multimedia Codecs

These high-performance multimedia codecs enable a series of popular audio, video and image applications using i.MX applications processors. The multimedia codecs are provided as a standalone software package to support various use cases, such as audio playback, video record and image display, with codecs for H.264, H.263, MPEG-4, Windows Media Video (WMV), Windows Media Audio (WMA), Advanced Audio Encoding (AAC) and Enhanced aacPlus. Also available are imaging codecs such as JPEG, GIF, PNG and BMP. The multimedia codecs support the GStreamer multimedia framework running on the Linux operating system and OpenMAX™ framework for Android.

For more information, visit freescale.com/iMXtools.

Kinetis Software Development Kit

Overview

The Kinetis software development kit (SDK) is an extensive suite of robust peripheral drivers, stacks and middleware designed to simplify and accelerate application development on any Kinetis MCU. The addition of Processor Expert technology for software and board-support configuration provides unmatched ease of use and flexibility. The Kinetis SDK is complimentary and includes full source code under a permissive open source license for all hardware abstraction and peripheral driver software.

Features

The Kinetis SDK consists of the following runtime software components written in C:

- ARM CMSIS Core and DSP standard libraries and CMSIS-compliant device header files
- An open source hardware abstraction layer (HAL) that provides simple, stateless drivers with an API encapsulating the functions of Kinetis peripherals
- System services for centralized resources, including a clock manager, interrupt manager, low-power manager and a unified hardware timer interface
- Open source, high-level peripheral drivers
- An operating system abstraction (OSA) layer for adapting applications for use with a real-time operating system (RTOS) or baremetal (no RTOS) applications. OSAs are provided for:
 - Freescale MQX RTOS
 - FreeRTOS
 - Micrium® μ C/OS-II®
 - Micrium μ C/OS-III®
 - Bare-metal (no RTOS)

Kinetis SDK Block Diagram

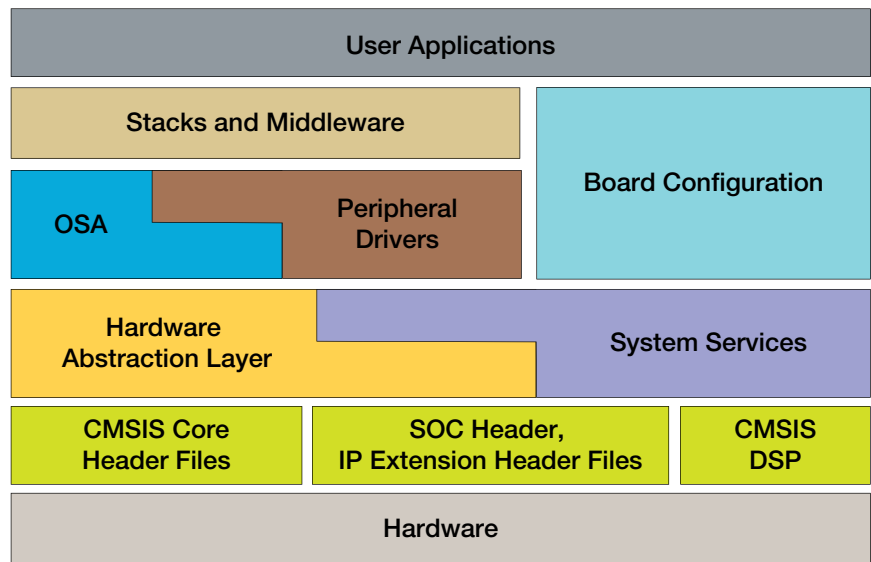

- Stacks and middleware, including:
 - A comprehensive device and host USB stack with comprehensive USB class support
 - CMSIS DSP, a suite of common signal processing functions
 - lwIP open source lightweight TCP/IP stack
 - FatFs, a FAT file system for small embedded systems
 - Encryption software utilizing the mmCAU hardware acceleration unit

The Kinetis SDK comes complete with software examples demonstrating the usage of the HAL, peripheral drivers, middleware, and RTOSes. All examples are provided with projects for the following toolchains:

- IAR Embedded Workbench®
- ARM Keil® Microcontroller Development Kit
- Kinetis Design Studio (KDS) IDE
- GNU toolchain for Cortex-M with makefile system

In addition to the software source, Processor Expert software configuration tool is provided as a time-saving option for software configuration. Processor Expert software configuration tool is a complimentary PC-hosted software configuration tool (Eclipse plug-in) with complete knowledge of all Kinetis MCUs. It provides a graphical user interface to handle MCU-specific board configuration and driver tuning tasks, including:

- Optional generation of low-level device initialization code for post-reset configuration
- Package IO allocation and pin initialization source code generation
- Creation and management of HAL and peripheral driver C source code configuration structures

For more information, visit freescale.com/KSDK.

Kinetis Design Studio IDE

Overview

The Kinetis Design Studio is a complimentary integrated development environment for Kinetis MCUs that enables robust editing, compiling and debugging of your designs. Based on free, open-source software including Eclipse, GNU Compiler Collection (GCC), GNU Debugger (GDB), and others, the Kinetis Design Studio offers designers a straightforward development tool with no code-size limitations. Processor Expert software saves time and effort with its knowledge base helping start application development with a few mouse clicks.

Features

- Eclipse Kepler 4.3
- Host operating systems:
 - Windows 7/8
 - Linux (Ubuntu, Redhat, Centos)
- GDB debugger interface can be used in Eclipse or driven from Command Line with support for the following debug interface hardware:
 - SEGGER J-Link (with SEGGER GDB Server)
 - P&E Multilink (with P&E GDB Server)
 - CMSIS-DAP (with OpenOCD GDB and OpenSDA embedded circuit)
- Support for additional downloadable Eclipse plug-ins including RTOS-awareness (such as MQX and FreeRTOS)
- Processor Expert software with support for Kinetis SDK
- Project wizard to create bare metal, Kinetis SDK and Processor Expert projects
- Languages supported:
 - Assembly, C and C++ (all with no code size restrictions)

Kinetis Design Studio IDE Block Diagram

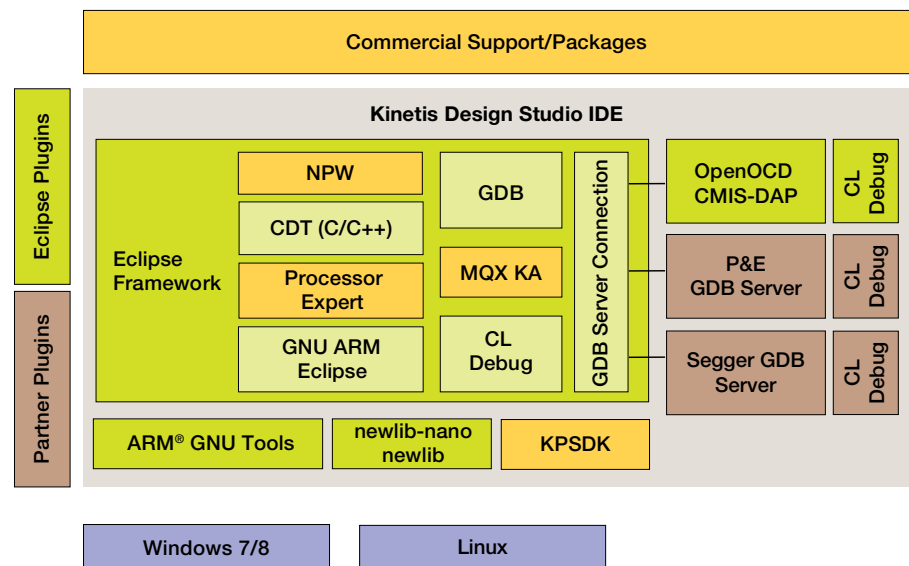

- Libraries included:
 - newlib 1.19 and newlib-nano 1.0
- Industry standard Eclipse Framework with CDT for C/C++
- Kinetis SDK peripheral drivers and CMSIS compliant startup code
- GNU ARM Eclipse plugins for managed make projects
- ARM GNU gcc build tools (4.8)
- Support for MQX project creation and MQX Kernel Awareness (available as MQX download)
- Supports Eclipse plugins either from the Eclipse ecosystem or from partners
- Optional commercial support packages

For more information, visit freescale.com/kds.

Partner Enablement Solutions

Design and support ecosystem for embedded solutions

ARM Ltd.

Software Development Tools

Keil MCU Development Kit

The Keil MCU Development Kit (MDK-ARM) supports all ARM Cortex-M MCUs, including our Kinetis MCU family. It combines the μ Vision™ IDE/debugger with ARM Compiler toolchain to provide developers with an easy-to-use, feature-rich environment.

MDK provides many unique features designed to help you quickly develop your project including:

- Device database
- Trace and analysis tools
- Fully functional RTX real-time operating system
- Extensive middleware

Additionally, MDK-ARM consists of several powerful components for debugging and analysis:

- ARM compilation tools
- Debugger
- System viewer
- Analysis tools
- Configurable logic analyzer
- Performance analyzer
- Execution profiler



Development Studio 5 (DS-5)

The ARM Development Studio 5 (DS-5) is a complete suite of software development tools for ARM processor-based cores, including Vybrid controller solutions, i.MX applications processor, and QorIQ LS1 processor families. DS-5 accelerates software development by providing an easy-to-use, integrated toolchain.

Key Features and Benefits

- Integration with the industry standard Eclipse IDE, which provides a large ecosystem of third-party plug-ins

- Powerful C/C++ compilation tools
- Debugger supports all phases of development from bootloader to Linux/RTOS kernel and applications
- System-wide performance and power analysis for Linux and Android
- Correlation of performance bottlenecks (e.g., cache misses, interrupts) and software execution
- Fast simulator for ARM software development on the host computer with typical speeds above 250 MHz
- Support and maintenance contract
- Flexible C/C++ editor and project manager

Hardware Development Tools

Keil ULINK and ULINKpro

All ARM Cortex-M-based devices feature ARM CoreSight™ technology with advanced debug and trace capabilities. With a ULINK adapter it allows the user to control the CPU, single step one source or assembler line, set breakpoints while the processor is running, and read/write memory and peripheral registers on the fly. All ARM Cortex-M3 and Cortex-M4 devices provide data and event trace. MDK provides a number of ways to analyze this information while your system is running, including a trace window, debug viewer, exceptions window, event counters and a logic analyzer.

All Cortex-M devices with ETM provide instruction trace. The Keil ULINKpro is the only trace adapter that streams instruction trace directly to your PC. This enables debugging of historical sequences, execution profiling and code coverage analysis. The virtually unlimited stream of trace information enables MDK to provide complete code coverage of your program. Code coverage identifies every instruction that has been executed, ensuring thorough testing of your application. This is an essential requirement for complete software verification and certification.

DS-5 Debugger and DSTREAM



DSTREAM™

The ARM DSTREAM high-performance debug and trace unit enables software debug and optimization on any ARM processor-based hardware target. DSTREAM enables the connection of DS-5 debugger and third-party debuggers to ARM processor-based devices via JTAG or serial-wire debug. DSTREAM uses FPGA acceleration to deliver high download speeds and fast stepping through code on single- and multi-processor devices.

Energy Probe

The ARM Energy Probe is an easily deployable Streamline accessory that collects voltage, current and power from up to three probe points in the system to allow software developers to optimize system energy consumption.

For more information, please visit freescale.com/ARM.



Adeneo Embedded

Runtime Software: Application Specific, Middleware and Operating Systems

BSP Reference Solutions

Adeneo Embedded is a leading system integrator focused on complete embedded systems development and provides reference board support package solutions for Freescale's products including i.MX microprocessor, Vybrid controller, Kinetis MCUs and QorIQ LS processor families. We specialize in and provide BSP reference solutions on the following operating systems: Android, embedded Linux, QNX and Windows Embedded Compact.

Multimedia and Graphics Solutions

Our multimedia and graphical solutions are based on Qt and Silverlight technologies. Enabling customer to design their applications quickly is our focus as we optimize the Qt environment to match customer application requirements including low level h/w acceleration libraries. We currently offer Qt enabled BSPs for the i.MX 6 series of microprocessors.

SSI Services

Software Solutions Integrator

Our service offering are designed to cater to the various stages of the customer project. We provide early design consulting and support for customers in evaluation phase, reference BSP maintenance and support during prototyping, customized BSP development and optimization for final product implementation. Product specific testing and market specific certification services are also offered as customers move to production phase.

Along with the reference BSP solutions, we also provide complementary technology integration services that include: Qt-enabled BSPs, advanced Power management solutions, Fast boot implementations, optimization for graphics performance (Vivante IP, etc.) and third party stack integration for connectivity and cloud related services.

10 YEARS Of strong collaboration with Freescale and many OS providers

70+ Engineering team experts in system integration on complex Embedded devices

300 OEMs Supported each year on OS and Software integration

END 2 END OS and Software expertise Multi-OS Support to provide the most adequate solution

QA Testing and Validation Drivers
 Graphical User Interface Performance Optimization Boot Time Optimization **BSP** Real-Time Performances
 Middleware Wireless Connectivity Stacks Power Management

Vertical Market Expertise

With BSPs as a fundamental starting point we also provide services addressing several vertical markets. Combining our expertise with an ecosystem of industry leading partners we bring these complementary market specific technologies to you.

Internet of Things (IoT)

- Sensor integration using Kinetis (MQX/FreeRTOS)
- Supervision devices development and integration with sensors using i.MX (Linux, WEC, Android, QNX)
- Gateway solutions using QorIQ LS1 (Linux, Android)

Medical

- Complete BSP adaptation to suite medical devices
- Graphics/video imaging optimizations
- Connectivity solutions with Wi-Fi/Bluetooth/NFC
- Medical industry certification and validation support to device makers

Industrial/Automation

- Real-time enabled solutions
- Industrial protocols/stacks integration
- Remote device management implementation

Automotive

- Fast boot implementation (<600ms)
- Real-time enabled solutions for control modules
- Special algorithm development for safety features
- Infotainment optimizations on video and audio
- Modern intuitive UI development

Handheld/Mobile

- Customized BSP solutions for different mobile devices
- Full power management implementation
- Connectivity solutions (Wi-Fi/Bluetooth/NFC)
- Security and device management

Training Services

As a chosen training partner of Freescale, Adeneo, has developed training sessions jointly with Freescale on the major operating systems. Training sessions range from one day to one week in-depth sessions and are available as "public" multi-customer events, ideal for initial technology ramp-up and as "private" on-site sessions to cover customer specific requirements.

For more information, please visit freescale.com/Adeneo-Embedded.



ENEAA

Runtime Software: Application Specific, Middleware and Operating Systems

Enea is a global supplier of Linux and real-time operating system solutions, including middleware, tools, databases, and world class services, with a vision to enable communication everywhere. As a trusted and respected player in the embedded software ecosystem, Enea has, for more than four decades, delivered value and helped customers develop and maintain ground-breaking products. Every day, more than three billion people around the globe rely on Enea's technologies in a wide range of applications in multiple verticals – from Telecom and Automotive, to Medical and Avionics. Enea sustains strategic partnerships with selected key customers, and a long-term co-operation with Freescale as a leading hardware supplier. Consequently, Enea's solutions are readily available for a wide range of Freescale products.

Enea Linux

Enea Linux is a Yocto compatible distribution designed to support communication centric applications with real time, virtualization and networking demands. Enea Linux is highly customizable: different kernel set-ups to provide different real-time behaviors, as well as a tailored set of packages, provides flexibility and real value to customers.

Enea Linux includes a complete set of exclusively open source industry standard tools that are verified and hardened to support all phases of software development.

Enea Linux Offering



ARM and Linaro Commitment

Enea's expertise around ARM started in the 90's, when it was already providing software solutions for ARM based architectures.

Linaro is the place where the world's leading technology companies define the future of Linux on ARM. Enea's membership in the Linaro Networking Group (LNG) and its support of the OpenDataPlane (ODP) initiative reinforces Enea's commitment to ARM and the networking space.

Embedded and Systems Management Middleware

Enea middleware solutions deliver the robustness, scalability, efficiency and portability needed to realize the potential of next generation network applications, whether completely embedded or in the Cloud.

Element

Enea Element provides a suite of embedded application development services for mission critical applications requiring event-driven real-time response, fault tolerance, and the highest levels of performance and scalability as per the Service Availability Forum (SAF) High Availability (HA) standards. Element is also ideal for many emerging Cloud based solutions for enterprise, especially when telecom style HA is required.

Polyhedra

The Polyhedra family of products are relational database systems designed for high-performance, high-availability embedded systems widely used in sectors such as communications, military and industrial automation.

For more information about Enea, please visit freescale.com/Enea.



Green Hills Software

Runtime Software: Application Specific, Middleware and Operating Systems

INTEGRITY® Multivisor™ Secure Virtualization

INTEGRITY Multivisor technology is the industry's most secure, reliable and flexible embedded virtualization solution. Leveraging hardware virtualization features found on the ARM architecture core, INTEGRITY Multivisor virtualization guarantees the safe and secure execution of open guest operating systems such as Linux, Android and GENIVI® running alongside system-critical applications and services found in automotive, networking and industrial applications.

INTEGRITY Real-Time Operating System (RTOS)

The flagship of the Green Hills Software family of operating systems, the INTEGRITY RTOS provides an advanced partitioning architecture for embedded systems that requires guaranteed reliability, absolute security and optimum deterministic real-time response. On Freescale processors with an MMU, the INTEGRITY RTOS guarantees applications the necessary CPU and memory resources while fully protecting the operating system, device drivers and other applications from errant and malicious code. Unlike other memory-protected operating systems, the INTEGRITY RTOS never sacrifices real-time performance for security and protection.

μ-velOSity™ Real-Time Microkernel

The royalty-free μ-velOSity microkernel is the smallest of the Green Hills Software RTOS family. Its frugal memory footprint of 2.6 KB and simple programming interface are perfect for lightweight applications running on Freescale MCUs without an MMU.

Software Development Tools

MULTI® IDE, TimeMachine™ and Optimizing Compilers

The MULTI IDE is a complete integrated development environment for embedded applications written in C/C++, and Embedded C++. It includes optimizing compilers, advanced multi-core debugger, profiler, run-time memory checking, MISRA C quality checker, project builder, editor, instruction set simulator and more.

The TimeMachine debugging suite extends the MULTI environment by leveraging trace data from Freescale processors, enabling embedded software developers to execute their application in reverse and find and fix bugs faster.



Device Lifecycle Management and Cryptographic Toolkit

Device Lifecycle Management (DLM)

A bundled product/service that protects and manages hardware and software IP during all facets of the manufacturing process against counterfeiting, cloning and other tampering.

High-Assurance Embedded Cryptographic Toolkit

A complete set of C- language cryptographic algorithms validated to FIPS 140-2 level 1 and meeting the NSA Suite B Standard.

Hardware Development Tools

Green Hills Processor Probes

The Green Hills Probe is an advanced multi-core, multi-user hardware device that connects through the JTAG or BDM. It enables deep visibility into the processor during board bring-up and, when used with the MULTI debugger, brings ultra-fast program download and run-control for multi-core application debugging.

Green Hills Software's SuperTrace™ Probe adds trace capability to the Green Hills Probe and can capture up to 8 GB of trace data on multi-core ARM architecture cores. With its exceptionally large storage capability, the SuperTrace Probe can collect billions of trace frames, radically extending program visibility to help find more bugs faster and with more precision.

SSI Services

Custom Engineering Services

Green Hills Software's Custom Engineering Services offer system architecture guidance and software development services, such as adding special features, customizing existing products and inventing new technologies.

Services include custom development for new architectures, DSP specialization, Frozen Branch, MULTI IDE customization, advanced debugging, third-party extension/porting, hardware solutions, customer services and instruction set simulators.

Supported ARM families

- i.MX, Kinetis, Vybrid
- MAC57
- QorIQ LS1
- Cortex A53/A57, A15, A9, A8, A5, M4, M0+ cores

For more information, please visit freescale.com/GreenHills.

IAR Systems

Software Development Tools

IAR Embedded Workbench for ARM

The complete C/C++ compiler and debugger toolchain IAR Embedded Workbench for ARM generates very efficient and reliable code for ARM devices. It is complemented by a range of in-circuit debugging and trace probes and integrated RTOS and middleware solutions from our partners. Multi-core debugging functionality, automatic NEON vectorization to support development and the runtime analysis add-on C-RUN is available fully integrated with the toolchain. In addition to this solid technology, IAR Systems offers training and extensive worldwide technical support.

Broadest Device Support

IAR Embedded Workbench is available for nearly the entire line-up of Freescale MCUs, including ARM Cortex-M4 and ARM Cortex-M0+ families, Vybrid controller solutions, i.MX processor families. It is integrated with Freescale MQX Software Solutions and Freescale Processor Expert. Regardless of which Freescale device is chosen, customers will experience the same intuitive user interface coupled with target-specific support for each device. IAR Systems also supports the Freescale Tower System development platform for Kinetis MCUs and Vybrid controllers, as well as the Freedom development platform.

State Machine Tools

IAR visualSTATE is a set of highly sophisticated and easy-to-use development tools for designing, testing and implementing embedded applications based on state machines.

Integrated Development Environment and Optimizing C/C++ Compiler

IAR Embedded Workbench

Offers the **broadest Freescale ARM/Cortex MCU coverage**
Simplifies Development
 Improves code quality
 Highly optimized

Kinetis Featured IDE

IAR Embedded Workbench for ARM was selected by Freescale as a featured IDE for future generations of Freescale's Kinetis MCUs. IAR Embedded Workbench and the Kinetis MCU portfolio are high-performance and feature-rich and let you create exceptional low-power applications and reduce development costs and time to market.

IAR Systems is offering a global competitive upgrade campaign to qualified CodeWarrior Developer Studio users. Get a head start with a powerful, reliable, user-friendly, tool chain here: iar.com/Freescale/migrate.

Runtime Analysis Tools

C-RUN is a high-performance runtime analysis add-on product, fully integrated with IAR Embedded Workbench for ARM version 7.20 and forward. C-RUN performs runtime analysis by monitoring application execution directly within the development environment. The tight integration with the toolchain improves development workflow and provides each developer with access to runtime analysis that is easy-to-use.

Hardware Development Tools

In-Circuit Debugging Probes

I-jet™ is a high-performance debugging probe that enables power debugging by measuring target power consumption with a high degree of accuracy. IAR Systems' innovative power debugging technology is a methodology that provides developers with information about how the software implementation of an embedded system affects the system's power consumption and allows optimizations for lower power consumption. This technology can be extended with I-scope™, which adds in-circuit current and voltage measurement capabilities to I-jet.

The real-time, in-circuit debugging probe JTAGjet™-Trace offers advanced trace functionality, such as full instruction trace and function profiling, for ARM and ARM Cortex-based applications.

For more information about IAR Systems, please visit freescale.com/iar.



Mentor Graphics

Runtime Software: Application Specific, Middleware and Operating Systems

Mentor Embedded Nucleus® RTOS, Embedded Linux and Hypervisor

Use the Nucleus RTOS, a scalable 3 Kb micro-kernel based RTOS deployed on over three billion devices, to develop high performance, reliable, graphically demanding and connected systems that consume minimal power. The safety certifiable Nucleus RTOS enables you to meet the needs of the most demanding medical, industrial and Internet of Things devices.

Mentor Embedded Linux enables you to address demanding requirements of embedded systems such as booting under one second. The instrumented kernel and middleware are complemented with graphical debugging and performance analysis tools to speed system optimization.

Mentor Embedded Hypervisor is Type 1 hypervisor ideal for producing high performance applications on multi-core processors. Take advantage of support for ARM TrustZone® for system security partitioning and boot multiple operating systems efficiently while using standards-based inter-processor communication features.

Automotive Solutions Mentor Graphics

Mentor Embedded Automotive Solutions

Mentor Embedded provides advanced embedded electronics engineering solutions for AUTOSAR based ECUs, automotive networks, ADAS, Infotainment and Instrument Clusters.

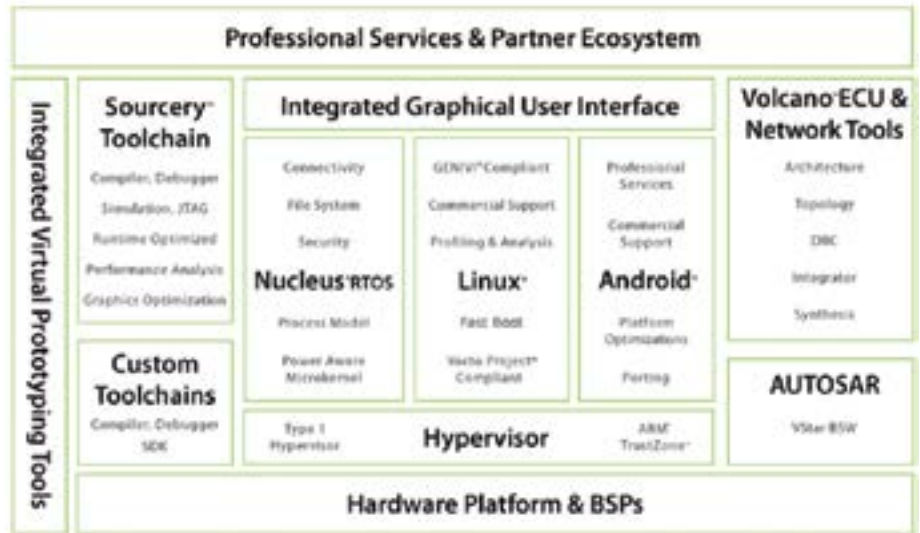

The Volcano™ family of AUTOSAR products includes system design, network design tools, virtual validation tools, test tools, and embedded software for automotive electronic and software systems using multiplexed communication networks.

Deliver differentiated automotive infotainment (IVI) systems with the Linux based XSe automotive hardware platforms from Mentor Embedded. Incorporate advanced audio noise control, surround view based ADAS capabilities and connected applications with software, hardware design and architecture technology and services from Mentor.

Produce rich digital clusters and augment analogue instruments with automotive graphics and video solutions from Mentor. From low-end single displays to integrated rich graphics that composite multiple displays, Mentor provides unique video synchronization technology and services to deliver differentiated user experiences in the vehicle.

Software Development Tools

Mentor Embedded Sourcery™ CodeBench

Sourcery CodeBench provides developers with an array of C/C++ development tools to create, debug, optimize, and analyze software systems on ARM and Power based devices. Take full advantage of single, multi-core and heterogeneous devices from Freescale for configuration, deployment and debugging features that scale from a microcontroller to multi-operating system based implementations. Sourcery CodeBench includes:

- Eclipse-based integrated development environment (IDE)
- Debugging support and tools that scale from bare-metal to multi-OS devices
- Profiling and analysis engines with advanced data visualization
- Performance optimized GNU compiler (GCC)
- Performance optimized libraries
- Graphics performance optimization
- Simulators and additional utilities

For more information on Mentor Graphics, please visit freescale.com/MentorGraphics.

QNX Software Systems

QNX™ Software Systems Limited, a subsidiary of BlackBerry® Limited, was founded in 1980 and is a leading vendor of operating systems, development tools, and professional services for connected embedded systems. Global leaders depend on QNX technology for their in-car electronics, medical devices, industrial automation systems, network routers, and other mission- or life-critical applications.

Runtime Software: Application Specific, Middleware and Operating Systems

QNX Neutrino® RTOS

The QNX Neutrino RTOS is a full-featured, multi-core operating system with advanced security and fault containment mechanisms built directly into the OS and kernel. The QNX Neutrino RTOS is complemented by a graphics architecture that enables the creation of next generation HMI's using open standard technologies such as HTML5 and Qt.

The QNX Neutrino RTOS has been qualified to various safety and security standards for use in products with high criticality and low tolerance for failure, and it has several certified variants:

- QNX OS for Automotive Safety
- QNX OS for Medical
- QNX OS for Safety and Security
- QNX OS for Security
- QNX OS for Safety

QNX SDK for Apps and Media

The QNX SDK for Apps and Media allows device manufacturers to build mobile-like UIs with full multimedia capabilities. It offers optimized browser performance, cutting-edge HTML5 features, consumer electronics device connectivity, and audio and video playback.

QNX CAR™ Platform

The QNX CAR Platform for Infotainment is a unique set of pre-integrated and optimized technologies from QNX Software Systems and automotive ecosystem partners. It provides a variety of options for building reliable, world-class infotainment systems.

QNX Powers What Matters



Software Development Tools

QNX Momentics® Tool Suite

The QNX Momentics Tool Suite is a comprehensive, Eclipse-based integrated development environment with innovative tools that give developers at-a-glance views of real-time interactions, memory profiles and more, enabling shorter debug times and faster time to market. Multi-core-specific tools help developers migrate code cleanly from single-core to multi-core systems, and help safely optimize performance.

QNX Acoustics for Active Noise Control

QNX Acoustics for Active Noise Control is a software solution used to dramatically reduce unwanted engine noise inside the cabin of a vehicle. The high performance, flexible library integrates with existing vehicle hardware.

QNX Acoustic for Voice

QNX Acoustics for Voice is a modular library of field-proven echo cancellation and noise reduction algorithms that improve the clarity and quality of hands-free calls and the accuracy of voice recognition, in challenging acoustic in-car environments.

SSI Services

QNX Professional Services

QNX professional services provides cost-effective assistance and expertise throughout the development cycle, including flexible support programs, professional training, expert consulting, and custom engineering. QNX services complement and enhance an organization's strengths to help meet their time to market goals within budget and on spec for high quality end products.

QNX Automotive Services

QNX automotive services provides quality engineering support to help tier one system integrators and OEMs eliminate program delays and meet or exceed project milestones and start of production (SOP) commitments. QNX automotive services has dedicated automotive engineers with first-hand experience in hundreds of production models, and the team uses this expertise to deliver successful results.

For more information about QNX, please visit freescale.com/QNX.



Wind River

Run-Time Software: Application Specific, Middleware and Operating Systems

VxWorks and Wind River Linux

Wind River® proudly supports Freescale i.MX and QorIQ LS processors with both its VxWorks® real-time operating system (RTOS) and its Linux offerings.

VxWorks is the industry's most widely deployed RTOS, powering over 1.5 billion devices. Its breakthrough new release, VxWorks 7, is a modular, expandable, future-proof platform for connected devices, engineered to help manufacturers of embedded systems harness the opportunities of the Internet of Things. Industry-specific add-on profiles enrich VxWorks 7 with relevant middleware, transforming it into a purpose-built RTOS platform for the industrial, medical, networking, and consumer electronics industries.

Wind River Linux is the best-in-class commercial embedded Linux, based on Yocto Project 1.5 open source development infrastructure. Wind River Linux delivers all the advantages of open source, plus the vision, innovation, risk mitigation, and support that only a technology leader can provide.

Software Development Tools

Wind River Workbench and Wind River Simics

The pressures to develop more efficiently are real. You're building complex products with shrinking budgets and distributed teams, and your competition is moving at a dizzying pace. Wind River has designed a collection of technologies and professional services to help you power through critical activities in every phase of your development lifecycle.

Wind River Workbench is an Eclipse-based integrated development environment that features a comprehensive suite of

A Foundation for Your Innovation



configuration, analysis, and debugging tools. Its new state-of-the-art System Analysis package provides instant access to code and system behavior, allowing developers to simultaneously optimize code and detect bugs, memory leaks, and interlocks.

Wind River Simics® is a full-system simulation tool compatible with both VxWorks and Wind River Linux. Simics enables continuous system integration; faster prototyping using virtual prototypes; and efficient what-if architectural analysis. Simics delivers a shared platform for software development so multiple developers can share a complete virtual system and its entire state, accelerating software development and testing.

SSI Services

Wind River Professional Services

Wind River Professional Services enables companies to reduce risk and gain a competitive advantage. Professional Services offers a variety of services around VxWorks platforms, including board support package (BSP) development and customization, boot optimization for selected hardware, and

secure boot services, in addition to solution assessments, consulting, and design.

Furthermore, Professional Services offers deep embedded Linux expertise across many processor architectures to expedite Linux platform delivery. Our offerings span across the entire project lifecycle, including architecture, design, development, porting, integration, and maintenance services; and we leverage our state-of-the-art platform simulation and test tools to accelerate deliverables and provide valuable reporting and documentation.

For more information about Wind River, please visit freescale.com/WindRiver.

WIND RIVER

Ac6

Ac6-training is a leading provider of training services on embedded systems, from the deepest hardware elements to the most advanced software components, including programming languages and their use for embedded systems. Freescale processors and MCUs are described with detailed hardware courses on CPU cores, peripherals and busses. Application-oriented courses with hands-on labs help you build industrial and embedded systems.

Ac6-training also covers low-end, bare-metal or RTOS-enabled MCU-based deeply embedded systems rather than high-end, Android, Linux or Windows-based systems; in all cases Ac6 covers both system-level or application-level subjects.

Ac6 has also developed innovative programming tools for building, programming and managing Linux embedded systems—the Ac6 System Workbench for Linux—that are provided free of charge to all Linux courses attendees.

To learn more, visit freescale.com/Ac6.



Advantech

Founded in 1983, Advantech delivers visionary and trustworthy network computing solutions that empower businesses. By embedding its innovative mission-critical hardware, leading telecom and networking equipment, manufacturers are able to power the world communications infrastructure. With an extensive deployed base, Advantech Networks & Telecom Group designs both standard and custom products for ATCA, MicroTCA and

OEM-ready network appliances. In partnership with major CPU, NPU and DSP manufacturers, the company partners locally with customers to evaluate project requirements, share design knowledge and develop optimized solutions together—all backed up by its global deployment expertise.

To learn more, visit freescale.com/Advantech.



AllGo Embedded Systems

AllGo Embedded Systems is a leading product design company focused on providing embedded multimedia solutions for automotive, consumer and general embedded market segments. Our solutions are used in over 50 products, deployed in more than 6 million cars and consumer products.

AllGo licenses its multimedia / Smartphone Connectivity software and ADAS solutions to automotive customers worldwide as well as provides associated services for software development and integration.

AllGo provides turnkey product design services and multimedia codecs for general

embedded customers.

AllGo RACE IVI software suite provides media and smartphone connectivity solution for the Automotive Infotainment systems.

AllGo Android Fastboot solution offers full availability of applications of Android in seven seconds from cold boot.

AllGoVision is an enterprise grade advanced video analytics solution which serves both as a server as well as an embedded based solution and is deployed worldwide in video surveillance markets.

To learn more, visit freescale.com/AllGo.



Altia Incorporated

Altia offers a concept-to-code tool suite for embedded display development. Altia Design is a GUI editor that provides the capability to create custom graphical user interfaces – without hand coding – and perfect user experience early in development. Altia's graphics code generator, Altia DeepScreen, generates pure C code for a wide array of low- to high-power Freescale processors, including Freescale MPC5645S, Freescale MPC5606S, i.MX 6, Vybrid and more.

Companies in the automotive, medical, home appliance, building automation and consumer electronics industries use Altia to get market-winning embedded GUIs into production devices.

Altia's Advantages

- Generates efficient C source code to minimize RAM and save BOM cost
- Can work with any OS or no OS at all
- Reduces development time by an average of 50%

- Advanced features for support of global languages
- Services team available to design best user interface and user experience

To learn more, visit freescale.com/altia.



Analogue & Micro Ltd

Analogue & Micro are a provider of electronic design services, COTS systems and modules, specializing in 32-bit embedded processor systems. Design experience for Freescale ARM architecture based platforms includes the QorIQ LS1 series and the i.MX processor family. Their platforms have been proven successfully in specialist solutions for high end industries including military, aerospace, oil and gas, utilities, data communications and audio/video

applications. Our platforms range from module and bespoke single board computers, to fully qualified products.

Services include analog and digital design, PSUs, PCB design, VHDL and software development, qualification, project management and logistics. A&M has extensive software experience in Linux, U-Boot and eCos operating systems and BSP and tool chain development using Yocto and Poky.

They offer rapid prototype build and manufacturing capability in house and are ISO 9001 certified.

To learn more, visit freescale.com/AM.



Arcturus

RUNTIME SOFTWARE: APPLICATION SPECIFIC, MIDDLEWARE, OPERATING SYSTEMS

IP Voice Communication, Management, IoT/M2M Middleware and System Solutions

Arcturus Networks, Inc., is a leading provider of embedded solutions for communication and industrial applications. Recognized as a pioneer, Arcturus has contributed to the innovation of thousands of products and helped establish embedded Linux as a defacto global standard. Since 2002, Arcturus has focused on developing middleware to enable device management, IoT/M2M, IP audio distribution and IP voice

communication, including audio intelligibility and psychoacoustics. Arcturus middleware, reference designs and modular hardware systems reduce time-to-market and risk by combining proven solutions with direct support.

Arcturus has partnered with Freescale for over a decade, recently developing specialized hardware designs with bundled middleware packages targeting buildings, transportation and healthcare markets. Arcturus is a member of the ARM Connected Community and supports a full

range of Freescale architectures from Freescale Kinetis and Cortex-M4 microcontrollers to i.MX application processors—using Linux, Android, MQX or bare-metal software.

To learn more, visit freescale.com/Arcturus.



Asset Intertech

HW DEV TOOLS

Asset Intertech is a leading supplier of hardware-assisted debug tools, providing probes and trace port analyzers with flexible debug connectivity for Freescale devices with ARM cores. With the daily tasks of the software developer in mind, SourcePoint™, ASSET's flagship debugger, is rich in firmware development attributes necessary for SoC development and powerful enough for applications development. Using SourcePoint, the software developer is provided maximum visibility into the complex hardware-software and software-software interactions, like firmware reset

issues, OS aware thread interactions and provides trace with post trace data mining. It includes address translation, dynamic page translation, multiple code formats, and a self-diagnostic test suite. It operates in multi-processor and multi-cluster environments and runs on either MS Windows or Linux hosts. SourcePoint offers UEFI and Linux OS-aware features.

The Arium LX-1000 Trace Port Analyzer (TPA) and the Arium LC-500Se are the most popular probe configurations. The LX-1000 is modular

and supports either parallel ETM trace or serial trace. The LC-500Se offers reliable run control and intuitive stepping features. It's designed for speed with fast file and image downloads and quick stepping through code.

To learn more, visit freescale.com/AssetIntertech.



Atollic

SW DEV TOOLS | SSI SERVICES

Atollic® is committed to helping engineers create better embedded systems with C/C++ development and testing tools that provide unique features for improving software quality. Unlike traditional C/C++ development tools, the Atollic TrueSTUDIO® IDE guides users through the process of developing high-quality embedded software. Atollic TrueSTUDIO brings the best principles from the automotive and aerospace industries to all embedded developers.

Atollic TrueSTUDIO is a world-class compiler and debugger IDE with integrated features for source code reviews, MISRA C checking, code complexity analysis and team collaboration.

The debugger includes a crash analyzer and RTOS kernel awareness, as well as dual-core and multiprocessor support.

Atollic TrueVERIFIER® adds in-target software test automation with auto-generated and auto-executed unit tests, enabling better-tested products.

Atollic TrueANALYZER® adds system-level test quality measurement, performing in-target execution flow analysis (up to MC/DC coverage) and providing test and quality confidence.

Atollic's development services complement their development and testing tools: Atollic TrueSTUDIO, TrueVERIFIER and TrueANALYZER.

Focused on Kinetis, Vybrid and i.MX processor families, development services deliver lower development costs, shorter time to market, lower risk of field upgrades and fewer field returns. Typical services include customized software platforms, application development, integration of middleware, wireless connectivity, software testing, code compliance, and metrics and source code review.

To learn more, visit freescale.com/Atollic.



Au-Zone Technologies, Inc.

The Au-Zone Vision Tool Kit enables developers with a solution to solve complex and demanding Embedded Computer Vision and real time Video Analytics problems they face. The product has been optimized for the Freescale i.MX 6 processor family which supports a unique, feature rich library of GPU accelerated embedded computer vision primitives.

Standard OpenCV functions are implemented for rapid development and algorithm porting from Matlab or PC-based implementations. The architecture is based on a modular GStreamer plugin Architecture with DMA based

zero copy buffers for real time video rates. By leveraging our Embedded Computer Vision Acceleration Library, we are able to help our clients to achieve significant and immediate performance improvements for complex algorithms while reducing the CPU loading for other applications. The SDK supports efficient algorithm development using workstations before targeting embedded devices.

Au-Zone supports the Toolkit with professional services including turnkey product development.

To learn more, visit freescale.com/AuZone.



BCM Advanced Research

BCM Advanced Research is a global supplier of embedded CPU boards and systems for the industrial, OEM/ODM, and embedded computing industries. They provide both standard off-the-shelf products as well as custom ODM design and manufacturing services for qualifying OEMs. Of these products BCM offers ARM based CPU boards and development kits based on the i.MX 6 series applications processor family.

Their strength lies in their strong engineering and project management presence in the USA complementing their core R&D and manufacturing capabilities in Asia. Established in 1990, BCM is one of the top embedded motherboard and system manufacturers. Their focus is providing value-oriented computing platforms with extended lifecycles that appeal to volume driven OEMs.

To learn more, visit freescale.com/BCM.



Bluetechnix

Optimized embedded systems and sensor solutions of highest quality—experts in 3D time-of-flight sensor technology

In business since 2004, Bluetechnix is well known for being a manufacturer of high-quality embedded systems such as time-of-flight (ToF)-based depth sensors, 2D smart cameras and system on modules (SoM) for Blackfin® DSPs and i.MX applications processors using ARM technology. More than 20 developers continuously expand the Bluetechnix broad product and service portfolio. Their R&D department is tightly connected to the Vienna University of Technology

(TU Vienna), UAS Technikum Wien and the Austrian Academy of Science to incorporate the latest technological advancements in their applications. Bluetechnix provides an ISO-accredited test center for electromagnetic compatibility (EMC) measurements at its development headquarters in Vienna, allowing them to provide product certification services in-house. State-of-the-art products, flexibility and personal support are the cornerstones of their long-term success.

To learn more, visit freescale.com/Bluetechnix.



BLUETECHNIX
Embedding Ideas

Borea

Borea is an independent design house based in Slovenia, Europe specializing in the development of complex high-performance embedded systems in the area of communications and beyond. We are a creative and innovative team whose dynamics allows us out of box solutions while at the same time keeping our services reliable and professional. Our core competence is built around high performance embedded

computing using QorIQ communications processors, Kinetis Microcontrollers and i.MX application processors. Borea focuses on special hardware and software implementations of systems where ultimate performance is expected. To fully unveil the maximum potential of Freescale chips we do multi-core programming at bare metal level.

To learn more, visit freescale.com/Borea.



Boundary Devices

Boundary Devices is a complete hardware and software solutions provider specializing in network-connected, fanless, low-power multimedia devices. With decades of experience designing ARM-based boards and numerous i.MX processor designs completed based on the i.MX51, i.MX53, and i.MX 6 processors, Boundary Devices is uniquely positioned to provide customers the perfect solution for i.MX processor-based designs. In the i.MX 6 family, Boundary Devices has released a wide variety of

products, including the BD-SL-i.MX 6 series low-cost development platform, the Nitrogen6X single board computer, and the Nitrogen6X-SOM.

These products were designed to allow customers to get to market quickly and with a reasonable price. In situations where the standard product is not quite right, Boundary Devices can design custom hardware platforms with associated BSPs. The key to any embedded project is software support, and the i.MX 6 platform from Boundary Devices supports many

different operating systems including QNX, Android 4.1 Jelly Bean, Windows Embedded Compact 7 and various flavors of Linux.

To learn more, visit freescale.com/BoundaryDevices.



CompuLab

CompuLab, established in 1992 is a leading manufacturer of computer boards for embedded systems and has been manufacturing system-on-modules of its own design since 1997. Producing over 100,000 computer boards a year, CompuLab system-on-modules can be found in over 1,500 products of some of the world's leading companies. The CompuLab portfolio includes the Utilite fanless computer in a mini form factor as well as system on module boards based on the i.MX 6 series processor

family. CompuLab boards are embedded in telecommunication systems, automotive devices, gaming systems, medical devices, aerospace and marine systems, and countless other applications. All CompuLab products are manufactured and tested in CompuLab's facilities in Yokneam, Israel. CompuLab products are lead free, RoHS compliant and meet all environmental standards. CompuLab is an ISO 9001:2008 certified company.

To learn more, visit freescale.com/CompuLab.



Cosmic

Cosmic Software is a leading producer of software development tools and services for the embedded systems industry. Cosmic development tools are used in the creation of electronic systems found in a variety of products including: automobile transmissions, anti-lock brakes, air bag controllers, washing machines, pacemakers, mobile phones, fiber optic switches, heavy construction equipment, avionics, robotics and many more.

Established in 1983 and headquartered in France, Cosmic Software operates subsidiaries in the United States and Germany along with a

worldwide network of distributors to provide local support. Cosmic Software is committed to giving its customers the best available software tools and support services to enable them complete and test their projects efficiently.

Cosmic Software product portfolio includes C-language cross-compilers, assemblers, processor simulators, hardware debuggers, Unit Test and MISRA syntax checker, and an easy-to-use integrated development environment (IDE) for Freescale Kinetis Microcontrollers.

To learn more, visit freescale.com/Cosmic.



Crank Software

Crank™ Software, Inc., is an innovator in embedded user interface (UI) solutions, reducing the time, costs, and headaches that notoriously come hand-in-hand with UI development by letting designers and engineers work side-by-side. Compared to traditional electronic design automation tools, our products and services enable R&D teams to more quickly develop rich graphical displays for resource-constrained embedded devices.

Crank Storyboard™ Suite bridges the gap between UI design and embedded systems to deliver competitive advantage, because streamlining the development lifecycle enables their customers to get products to market with higher ROI and lower TCO, while delivering a superior customer experience.

Storyboard makes it easy for i.MX users to build graphical UIs and ultimately get their products to market faster. With a shorter development time

and a more collaborative process, products get to market first with a remarkable UI that builds brand loyalty.

To learn more, visit freescale.com/Crank.



Cybercom

Cybercom is Freescale's Proven partner for Bluetooth connectivity. For 15 years, Cybercom has been contributing in the evolution of Bluetooth technology, developing systems and products for automotive, medical, consumer and industrial applications. Together, Freescale and Cybercom are able to provide robust Bluetooth connectivity, meeting vehicle manufacturers' requirements on the latest Bluetooth features and device interoperability. Cybercom blueGO significantly reduces time to market and the need for device interoperability testing.

Cybercom blueGO is a professionally maintained

Bluetooth software application framework, offering tier-1 suppliers a robust, generic and portable multi-profile and multi-connection Bluetooth solution. The underlying stack, integrated in the solution delivered by Cybercom, is the market-leading Blue SDK Bluetooth stack from its partner iAnywhere.

Cybercom is a Nordic consulting company, designing and adding intelligence to products and devices, assuring efficient and manageable connectivity, providing a future connected world with meaningful solutions.

To learn more, visit [freescale.com/Cybercom](https://www.freescale.com/Cybercom).



Develco A/S

Develco provides total solutions for wireless design including the DevCom 08 ZigBee module based on the Kinetis microcontroller family. In addition, Develco provides professional design services (HW, SW, RF, product and test equipment), production (handling of 3rd party OEM), IP (ZigBee), modules (ZigBee), tools (ZigBee) and products (ZigBee and Wireless M-Bus). Develco serves most regions worldwide, from their head office in Denmark.

To learn more, visit [freescale.com/Develco](https://www.freescale.com/Develco).



Digi International

Digi provides wireless solutions for vertical M2M applications, including purpose-built products for medical devices and energy applications. Its low-cost development kits make it easy to get to market quickly. Full support is provided for Android, Linux and Microsoft Windows Embedded Compact. The Device Cloud™ by Etherios, a Digi International company, provides remote monitoring and control from anywhere in the world, and the new Device Cloud Connector

provides built-in cloud connectivity for Freescale MPUs and MCUs. Products include Systems-on-Modules (SOMs) for Freescale i.MX28 and i.MX53 applications processors with integrated 802.11a/b/g/n wireless and Bluetooth 4.0. With application and wireless design services, Digi and Etherios are true end-to-end wireless solutions experts.

To learn more, visit [freescale.com/DigiInternational](https://www.freescale.com/DigiInternational).



Elektrobit

EB's automotive software business has established itself internationally as one of the most important suppliers of embedded software solutions for the automotive industry. In addition to the development of innovative products, EB also specializes in services and consulting supplying implementations of serial software solutions for a broad range of infotainment, navigation, HMI, driver assistance and AUTOSAR systems. Based on more than a decade of expertise in developing software for automotive ECUs, EB offers industry-leading basic software

and corresponding configuration and analyzing tools. As a full-service provider, EB's global and knowledgeable ECU service teams take over responsibility for specific parts or even for the whole project when introducing the latest technologies like Ethernet, multi-core systems, or ISO 26262-compliant functional safety products and solutions. Thanks to the close partnership with Freescale, EB's ECU software runs smoothly on several Freescale MCUs.

To learn more, visit [freescale.com/Elektrobit](https://www.freescale.com/Elektrobit).



Embedded Access, Inc.

The developers at Embedded Access are the world experts in the MQX RTOS Platform. They provide a full MQX based reference design, customized board support packages (BSPs), boot loader, legacy code integration, full application development, driver development and communication protocols. For a project quick start, a shell of your application can be created with all components customized to your specification ready for high level application code.

Embedded Access can provide a customized release of the MQX platform for just about any Freescale 32-bit MCU or MPU including the Freescale MQX RTOS, RTCS TCP/IP stack, MFS file system, USB host, USB device, web server and more. Add-on packages are available, including GUI development, flash file system, XML Parser & Framer, SNMPv3 and the LUA scripting language.

RUNTIME SOFTWARE: APPLICATION SPECIFIC, MIDDLEWARE AND OPERATING SYSTEMS | SSI SERVICES | SW DEV TOOLS

Embedded Access also provides training for MQX Platform to help you minimize costs and development time.

To learn more, visit freescale.com/EmbeddedAccess.



Embedded Labworks

TRAINING

Embedded Labworks is focused on helping you develop embedded software with quality and on-time delivery. Through consulting and training services, we can help you in all embedded software development stages.

Our consulting services can help you define the technical characteristics of the product (hardware and software), operating system selection and development tools. Our experience

in the open source community enables us to help our customers in selecting open source software components.

Relying on professionals with over 15 years of experience in the area, our trainings are very well know in Brazil and Latin America. Our experience in operating systems, including GNU/Linux and Android, enables us to help and prepare our customers to work with new technologies.

Our experience with real-time kernels, including MQX, FreeRTOS and Micrium uC-OS/III, enables us to train and help our customers to work with real-time systems.

To learn more, visit freescale.com/EmbeddedLabworks.



Embest

EMBEDDED BOARD SOLUTIONS | IDH SERVICES

Embest is a global provider of embedded hardware and software. Formed in 2000, it's now part of element14 and Premier Farnell, global electronic components distributors with more than 70 years in the business. Embest offers professional development tools, evaluation boards, single-board computers (SBC) and hardware and software development services and applications. It also is an authorized distributor of ARM, Parasoft®, Hewlett Packard® and Cadsoft™ in China. They provide embedded

development tools, single-board computers and core modules, as well as OEM/ODM services for embedded products. Its vision is to use its technology and services to help customers develop and produce embedded products faster, more efficiently and with a high level of quality. The company works closely with ARM and leading ARM-based MCU and MPU suppliers and is also an ARM-approved training center (ARM ATC). Customers are sure to receive high efficiency tools, mature embedded solutions,

design and production services and complete support from Embest.

To learn more, visit freescale.com/Embest.



Emcraft Systems

EMBEDDED BOARD SOLUTIONS | HW DEV TOOLS | IDH SERVICES
RUNTIME SOFTWARE: APPLICATION SPECIFIC, MIDDLEWARE AND OPERATING SYSTEMS

Emcraft Systems provides system on modules (SoMs) for the Freescale Kinetis K70/K61 and Vybrid VF6/VF5 devices. The SoMs are specifically designed to make it easy, quick and cost-effective for embedded system designers to start using the Freescale devices in their applications. Emcraft Systems' starter kits provide a low-cost hardware platform, enabling development of embedded applications using the Kinetis K70/K61 and Vybrid VF6 devices. The starter kits are based on SoMs, include a breadboard area and come with the schematics of the baseboard. This allows for

quick custom development and easy transition from prototyping to building an end product. The kits can be used either standalone or in the Freescale Tower System.

Emcraft Systems offers hardware design, embedded software development and turn-key contract manufacturing services for customers that use Emcraft SoMs.

Prerenegotiated prices and close relationships with our contract manufacturing partners allow Emcraft to quote custom baseboard turn-key projects. Thus, customers can leverage volume purchasing power to save money and time.

Emcraft Systems provides embedded Linux BSPs and cross-development environments for the Kinetis K61/K70 and Vybrid processor families. The cross-development environments for both Kinetis and Vybrid include the GCC cross-compiler and GDB debugger, as well as a number of preconfigured, ready-to-build and run sample projects to serve as helpful starting points for application development.

To learn more, visit freescale.com/Emcraft.



Emtrion

When it comes to high-quality and reliable high-end embedded systems design with a long-term useful life, Emtrion is the partner of choice. Emtrion produces hardware and software that helps drive smart companies forward. Its engineers, with more than 10 years of experience, provide customers with new and inventive embedded solutions again and again.

In keeping with its philosophy, Emtrion fosters partner networks that help it remain one step ahead in innovation. Its team is highly motivated

and specializes in partnering closely with clients to complete projects. Headquartered in Karlsruhe, Germany, Emtrion supplies companies around the world, the majority of which operate in the fields of automation engineering, medical engineering, measurement and control, as well as railway engineering.

Emtrion offers the following services: project management/coaching, technical seminars and workshops.

To learn more, visit freescale.com/Emtrion.



Engicam

Engicam was established in 2009 in order to simplify the development of innovative and technologically advanced products. Engicam merchandises several type of CPU modules based on the latest generation of Freescale processors.

Engicam has a full range of system-on-modules with the Freescale i.MX application processor family including i.MX25, i.MX28, i.MX51, i.MX53,

i.MX 6 series as well as the Vybrid VF600 processor. Engicam is providing their solutions for markets ranging from train, electrical car, vending machine, kiosk, and point-of-interest. Dedication, innovation and flexibility are some of the key strengths Engicam offers their customers when deliver a full turnkey solution.

To learn more, visit freescale.com/Engicam.



eSOL Co., Ltd.

As a leading embedded software developer, eSOL provides eSOL's real-time OS-based software platform for single-core, multi-core, and many-core embedded processors, automotive ECU development tools, and engineering services to accelerate development of applications requiring real-time capability and reliability. eSOL's embedded products and services are used worldwide in competitive vertical markets such as automotive, consumer electronics, industrial and medical equipment, and aerospace.

The multi-core-ready eT-Kernel Platform is built upon eSOL's scalable eT-Kernel real-time OS,

which is tightly integrated with the eBinder IDE including the ARM genuine compiler and a wide selection of middleware components. eT-Kernel Platform helps developers quickly create flexible development platforms for their software product lines and enables them to improve time to market, cost, productivity and quality. eT-Kernel and eBinder are expected to receive ISO 26262 automotive functional safety standard certification in 2014.

eSOL's products and services support the Kinetis, Vybrid and i.MX processor families.

To learn more, visit freescale.com/eSol.



F&S Elektronik

F&S Elektronik Systeme GmbH is a German electronics company located in Stuttgart. The company started in 1992 as a design office and in 1994 introduced its first product family a graphics display driven board. Today, F&S offers a wide spectrum of boards for the embedded market space including products based on the Freescale i.MX processor and Vybrid controller families. Their strategy is to offer complete solutions that included both the software and hardware components. So F&S ports the most

popular operating systems like Linux, Android and Windows Embedded Compact on its boards and offers additional software, hardware and support which makes using the boards very easy. Their goal is to offer innovative and reliable boards and devices with an excellent price/power ratio and with high quality support to our customers.

To learn more, visit freescale.com/FS.



FirstView

FirstView Consultants is an Austin, Texas-headquartered company with rapid prototyping, system architecture and software solutions expertise in the automotive, medical and industrial markets. They custom tailor solutions, such as filling in gaps all the way to developing complete designs from idea to working solution.

They can scope and lead turn-key production or augment a team for targeted modules. Their capabilities within embedded systems run the entire spectrum, from high-level planning and

system architecture to specific hardware and software duties. Their dedicated multimedia team can improve system performance by analyzing and optimizing the graphics, video, camera and image processing, and their software team can create custom BSPs or fill in the gap by providing the expertise to create specific drivers.

For more information, please visit freescale.com/FirstView.



FreeRTOS

RUNTIME SOFTWARE: APPLICATION SPECIFIC, MIDDLEWARE, OPERATING SYSTEMS

FreeRTOS is a market leading RTOS from Real Time Engineers Ltd. that supports more than 30 architectures and receives more than 100,000 downloads a year. It is professionally developed, strictly quality controlled, robust, supported and free to embed in products without any requirement to expose proprietary source code. FreeRTOS has become the de facto standard RTOS for MCUs by removing common objections to using free software, and

in so doing, providing a truly compelling free software model.

You can take a product to market using FreeRTOS without even talking to them, let alone paying any fees, and thousands of companies do just that. If, at any time, you would like to receive additional backup, written guarantees or indemnification, then there is a simple low cost commercial upgrade path. Your peace of mind comes with the knowledge that

you can opt to take the commercial route at any time you choose.

To learn more, visit freescale.com/FreeRTOS.



FriskyDSP Technology Ltd.

EMBEDDED BOARD SOLUTIONS | SSI SERVICES

FriskyDSP provides advanced embedded software engineering services and technology to customers around the globe. With a focus on Freescale based platforms, the company delivers a range of services deploying these platforms. The company's comprehensive development projects start from initial customer requirements through the delivery of verified and optimized code, and services including customization, integration, code porting across platforms, support and training.

FriskyDSP's in-depth knowledge, skill and broad system understanding help customers achieve optimal software design and implementation that deliver high-performance products to the market. This is particularly evident in customer applications with demanding processing requirements.

FriskyDSP partners with its customers to help them achieve their short and long-term development objectives. We pride ourselves in

our established and close relationships with our customers, serving as their outsourced R&D experts, providing high-performance solutions that ultimately save time, costs and resources.

To learn more, visit freescale.com/FriskyDSP.



G5 Engineering Solutions

EMBEDDED BOARD SOLUTIONS | IDH SERVICES

G5 Engineering Solutions, Inc., is a US based, full-service engineering design firm providing innovative solutions that are ready for the production line. They are committed to meeting complete product development needs by delivering quality turnkey products for commercial, industrial, medical and military use. They specialize in embedded ARM processor based motherboard design, low-level firmware design, low-level Linux/Windows driver design, high-level Android/Linux/Windows operating system board support package (BSP) integration and customization. The G5 product

portfolio includes a power sensitive as well as a performance based system on module based on the i.MX 6 series processor family. The G5 power state aware peripheral device drivers are first in class to minimize power draw when not in use to maximize battery runtimes in mobile devices. G5 is also extremely competent in designing systems to endure harsh environments (Mil-std-810/IP-57) which also require low EMI signatures (Mil-std-461/FCC).

To learn more, visit freescale.com/G5engineering.



GainSpan

GainSpan is an innovator and leader in semiconductor solutions for wireless connectivity for the rapidly emerging Internet of Things. GainSpan solutions let customers easily create connected products for the Connected Home, Smart Energy, healthcare/fitness, control/monitoring in industrial, commercial and residential markets and high-speed audio, video and security applications.

GainSpan's new ultra-low-power 802.11 b/g/n GS2000 is a highly integrated, multi-code, System-on-Chip (SoC) containing two ARM

Cortex-M3 processors. The solution is highly flexible: The IPv4/IPv6 networking stack and services usually run on the GS2000 when paired with smaller MCUs such as the Kinetis L family; however, the stack and services can run on MCUs/MPUs such as the i.MX family.

Together, GainSpan and Freescale are accelerating development and adoption of a whole new class of battery and line-powered connected devices.

To learn more, visit freescale.com/GainSpan.



Garz & Fricke

Garz & Fricke GmbH has been developing and producing intelligent embedded systems since 1992. Made in Germany, its products stand for quality and progressive technology.

With 86 engineers, computing specialists and technicians in hardware and software, Garz & Fricke GmbH is the perfect OEM supplier for industrial controllers, metering and labs electronics, intelligent displays for automotive and naval designs, as well as vending machine technology.

Their product portfolio contains application-ready products such as intelligent touch panel

computers, human-machine interface and/or control applications. Garz & Fricke provide full service from product set-up to mass production, including prototyping, hardware and software development. Their own THT and SMT production lines enable them to tune all related processes to each other.

Garz & Fricke GmbH focuses on a compact and complete touch panel series for integration into professional devices or standalone panels for the visualization and communication in industrial and home networks.

To learn more, visit freescale.com/GarzFricke.



Gateworks Corp.

Gateworks is a leading supplier of powerful ARM based network processor board level solutions for transmitting and receiving audio, video, and data in embedded wireless network systems.

The Freescale i.MX 6 series based family of network processor boards are motherboards designed specifically for embedded wireless network applications.

To learn more, visit freescale.com/Gateworks.



HandsOn-Training

HandsOn-Training is a company that specializes in providing technology courses that integrate practical work in FPGA and ARM areas. The tight relationship with the silicon vendors provides the newest courses for the newest platforms in the world, enabling engineers to acquire know-how on the newest devices without the need to travel abroad.

HandsOn-Training develops the course contents directly with silicon vendors, which leads to professional material that emphasizes and focuses on the engineer's daily work needs. Our vision is to "Establish a know-how and

excellence center in the FPGA and ARM segments." We do not provide theoretical courses – only practical ("Hands-On") training, employing the most advanced development tools, evaluation boards, operating systems and training material. In early 2013, we also began delivering courses in Europe in collaboration with our silicon partners, distributors and various training centers.

HandsOn-Training is delivering courses based on Freescale i.MX and Kinetis product families.

To learn more, visit freescale.com/HandsOn.



HILF!GmbH

As one of the leading training providers, HILF!GmbH offers more than 70 different, high-level topic centered training classes. As a global player, these courses are offered as on-site training as well. To date, HILF!GmbH has successfully trained more than 25,000 customers.

With a strong background working with Motorola, having started as an Authorized Motorola Training Partner in 1998, they provide comprehensive services for the complete Freescale portfolio.

These services include consulting and training, as well as system design and software development, successfully performed in more than over 120 projects for large customers in the automotive industry, industrial automation, avionics and telecommunication.

Their portfolio includes the i.MX5x family of processors, i.MX 6 series processors and Kinetis MCUs based on the ARM Cortex architecture.

To learn more, visit freescale.com/HILFGmbH.



Infobank Corporation

SSI SERVICES

Infobank is an automotive software company based in South Korea.

We have developed Android Infotainment/Connectivity Solution for Hyundai Motors since 2009 with Freescale. Our solution is based on the i.MX25, i.MX53 and i.MX 6 processor family.

We have four solution integrations and one hardware tool.

- Android Infotainment System Integration for Hyundai Motors (2011~)

- CarPlay Solution for Hyundai Motors (Linux/Android, 2013~)
- Android Auto Solution for Hyundai Motors (Linux/Android, 2014~)
- AUTOSAR Migration Service
- ECU Reflash Tool (i.MX25)

To learn more, visit freescale.com/Infobank.



iSYSTEM

HW DEV TOOLS | SW DEV TOOLS

iSYSTEM is a privately held company headquartered in Germany, close to Munich. Since its foundation in 1986, iSYSTEM is an independent manufacturer and provider of embedded software debugging and test tools supporting Freescale i.MX application processors and Kinetis Microcontrollers.

iSYSTEM's Blue Box Technology stands for fast and easy microcontroller access via any kind

of microcontroller debug interface. No matter whether one is developing, debugging or testing embedded software on a real target system, iSYSTEM's open and integrated Debug and Test Software enables engineers to drive a Blue Box and the corresponding development. iSYSTEM is a ISO 9001:2008 certified company.

For more information visit, freescale.com/iSystem.



iWave Systems

SSI SERVICES | EMBEDDED BOARD SOLUTIONS

iWave Systems is a design house specializing in the area of embedded hardware and software engineering services. iWave Systems is headquartered in Bangalore, India, which is considered to be one of the hottest technology centers in the world. iWave offers complete integrated solutions for product development and systems engineering.

Managed by technology professionals, iWave Systems is a registered private limited company with more than two decades of experience. iWave Systems has extensive experience in

industrial, automotive and medical domains.

iWave's products/services range from integrated real-time solutions and turnkey development, embedded software (e.g., RTOS, protocols, firmware, middleware/application, BSP, device driver development and porting services), board level hardware and FPGA design and development services, ASIC modeling, simulation and verification to DSP (audio and video codec).

To learn more, visit freescale.com/iWave.



Ka-Ro

Ka-Ro's family concept of Computer-on-Modules is unique. Ka-Ro is a full-service provider with its own reference kits, production-ready modules, Windows CE and Linux BSPs. Ka-Ro's comprehensive range of services covers customer- and application-specific development and component sourcing, and extends to individual or series manufacturing for the industrial investment product markets.

In the worldwide electronics market, Ka-Ro's Computer-on-Modules stand out with their unique characteristics, thanks to their superlatively small formats and low-power consumption. Its in-house, high-end production capabilities mean that Ka-Ro can offer aggressive, customer-oriented pricing.

To learn more, visit freescale.com/Karo.



Kontron

Kontron is a global leader in embedded computing technology. With more than 40% of its employees in research and development, Kontron creates many of the standards that drive the world's embedded computing platforms. Kontron's product longevity, local engineering and support, and value-added services help create sustainable and viable embedded solutions for OEMs and system integrators. Kontron works closely with its customers on their embedded application-ready platforms and custom solutions, enabling them to focus

on their core competencies. The result is an accelerated time to market, reduced total cost of ownership and an improved overall application with leading-edge, highly reliable embedded technology. Through an extensive portfolio, based on internationally accepted industry standards for hardware, software and connectivity, Kontron solutions range from COTS standard-based products, fully-integrated application-ready systems and platforms, as well as extended software service.

To learn more, visit freescale.com/Kontron.



Kozio

VTOS™ DDR™ is a standalone software application that runs from a processor's on-chip memory. VTOS DDR provides everything you need to quickly configure, verify, and tune DDR memory. This tool enables designers to automatically tune and verify DDR memory, and allows production test teams to test every cell of DDR memory in seconds. Support is available for Cortex-M4, Cortex-A8, Cortex-A9, and Cortex-A15 processors.

VTOS is a standalone software application that runs from a processor's memory. VTOS

provides everything you need to interrogate or validate all of the functional components of your printed circuit board design. VTOS stands for Verification and Test OS and is available for Kinetis and i.MX processors.

Kozio has provided embedded verification IP for over ten years, with expertise in ARM and Power Architecture, as well as bus interfaces, memories, and complex peripherals.

To learn more, visit freescale.com/Kozio.



Lauterbach

Debugger, real-time trace, logic analyzer

Lauterbach provides TRACE32®, an integrated debug environment for embedded designs. With its modular concept, the environment supports all ARM-based chip architectures and can be easily migrated to other processors by simply replacing the debug cable. Data—captured and traced from the core and from external signals on the PCB—provide this information, which support and accelerate the software development of embedded applications in many aspects. The major task of a debugger is root cause detection of a bug, but it also

provides Lauterbach TRACE32 with runtime measurements, code coverage tests and energy profiling dedicated functions to optimize embedded systems' safety, performance and power efficiency. The PowerView is the GUI to the developer, which analyzes and presents the traced data in alphanumeric or graphical form, even correlating it with the high-level language (HLL) source code. Lauterbach's TRACE32 tools are appreciated tools and used worldwide in the process of development, validation and certification of embedded software.

To learn more, visit freescale.com/Lauterbach.



Linear Technology

Linear Technology provides high performance analog solutions that support and are complimentary to system developers using Freescale's Kinetis, Vybrid, i.MX, and QorIQ processors/controllers. We help optimize power delivery and management for Freescale's latest products and also allow for increased robustness of systems that require high performance mixed signal ADCs and DACs to interface with Freescale ARM-based devices.

Linear Technology provides a wide array of demo boards, and proven reference designs for Freescale processors and uControllers.

To learn more, visit freescale.com/Linear.



Linux4biz

RUNTIME SOFTWARE: OPERATING SYSTEM SOFTWARE | IDH SERVICES

Linux4biz provides R&D professional services for Embedded Linux and Embedded Android platforms using Freescale i.MX application processors.

Services include:

- Device driver and BSP development
- Board Bring-up
- Android low-level development

- Android Framework and NDK Development.
- Special libraries integration
- Computer-vision development
- Turn-Key Product development based on Android & Embedded Linux.

To learn more, visit freescale.com/Linux4Biz.



Logic PD

IDH SERVICES | SSI SERVICES

Logic PD collaborates with clients to help them launch products that accelerate their growth and capture value in the Internet of Things (IoT). Logic PD helps at any stage in the product lifecycle by being the complete product innovation and product realization Company for connected devices in the world's most demanding markets. The Logic PD Catalyst M2M Engagement Kit based on the Freescale Kinetis MCU family with its "one-click" provisional patent portfolio

dramatically reduces the time and complexity of M2M development for customers. From system integration expertise to embedded and connected device offerings, Logic PD helps its clients identify opportunities, reduce risk, and control costs to deliver innovative products to market faster.

To learn more, visit freescale.com/LPD.



M2CoreTech

IDH SERVICES

M2CoreTech provides the total solutions required for various multimedia terminals such as hardware design, board-supported packages and software applications (e.g., codec and protocol).

The company's main business areas are AVN (for automatic), digital information display (DID), mobile TV, PND/portable multimedia player (PMP), smart terminal (for supporting the various functionality) and home network markets. Customers can enjoy the following benefits:

1. Easier development of their target product
2. Obtaining the best optimized performance
3. Speeding up entry into target markets

To learn more, visit freescale.com/M2CoreTech.



Micrium

Micrium is a global RTOS leader and a top choice of embedded engineers building microprocessor, microcontroller and DSP-based devices. Our μ C/OS is the number one commercial RTOS for embedded systems, featuring a wide array of connectivity, including TCP/IP, USB, CAN Bus, Bluetooth, plus file system and GUI support. Micrium is also the leading commercial RTOS vendor for ARM, in fact μ C/OS was the first RTOS kernel ported to ARM and has been ported to every ARM architecture since, through ARMv8.

Micrium's RTOS kernel and software components are recognized for their unparalleled reliability, performance, dependability, impeccable source code and extensive documentation. Our components are ideally suited to all embedded vertical markets, with some certified to meet the rigorous safety-critical standards demanded by industries such as medical electronics, avionics, and industrial products. Micrium's commercial RTOS family provides cost-effective performance and time-to-market advantages, which translates into substantial time and resource savings.

To learn more, visit freescale.com/micrium.



TRAINING

Microgenios

Microgenios is a Brazilian company founded more than 8 years ago, counting with a very qualified team it has proven experience on providing technical trainings on microcontrollers programming to local engineers. Microgenios is Freescale's training partner in Brazil region for Kinetis devices, the offered training portfolio covers microcontrollers programming aimed to

facilitate the development of new projects and reduce time-to-market.

Microgenios main focus is training their customers on Freescale Kinetis with ARM microcontrollers for both K (Cortex-M4) and L (Cortex-M0+) families.

To learn more, visit freescale.com/microgenios.



Micron Technology

Micron Technology is a global leader in advanced semiconductor systems, offering the industry's broadest portfolio of silicon-to-semiconductor solutions—starting with foundational DRAM, NAND, and NOR Flash memory, and extending to SSDs, modules, MCPs, HMC, and other semiconductor systems. This best-in-class technology powers leading-edge computing, consumer, enterprise server and storage, networking, embedded, automotive, industrial, and mobile products.

To meet Freescale's system and performance needs, Micron provides DRAM, NAND and NOR

Flash, e-MMC, embedded USBs, and SATA SSDs. These advanced memory and storage solutions are aligned to Freescale technologies and qualified on Freescale reference designs with ARM cores. This built-in compatibility reduces development costs and shortens the time to market.

Backed by more than 35 years of technology leadership, Micron has the expertise, product breadth, and packaging options to enrich the enablement and implementation of Freescale's embedded processing solutions. Platforms Supported: i.MX, Kinetis, Vybrid and QorIQ.

To learn more, visit freescale.com/micron.

COMPANION SILICON AND MODULES



MicroSys

MicroSys designs and develops embedded system solutions for VMEbus, CompactPCI and other common bus infrastructures. Since 1975, customized solutions offering longevity are trademarks of their business as well. Successfully deployed products span from systems-on-modules up to fully integrated systems.

In 2000, the miriac CPU module family expanded its product portfolio. The flexible and modular Module-Carrier-Konzept can be used for both evaluation purposes of processor technology and serial production. The miriac modules utilize

32-bit processors, such as Freescale's i.MX applications processors and other common embedded CPUs. With their low power consumption and the compact dimensions of a credit card form factor, the miriac modules can fit into any application in automotive, industrial automation, medical, railway, avionic, transportation, construction or defense. Operating systems such as VxWorks, Microware OS-9, QNX, Linux, WinCE or Micrium microC/OS are supported.

To learn more, visit freescale.com/MicroSys.

EMBEDDED BOARD SOLUTIONS



Motomic Software

Turn products into touchpoints

Motomic helps manufacturers leverage the Internet of Things to understand how their customers use their products. Once clients understand product use, Motomic helps them turn those products into touchpoints that engage customers.

Products are rapidly becoming connected. With that connectedness comes the ability to understand and interact with the customer base. Motomic opens products to analytics

and extends customer experience design to browsing, touchscreens and media on products, creating entirely new touchpoints with completely new rich customer experiences, even on tiny MCU-class processors.

End users are delighted by context-sensitive experiences that instruct, entertain and transact. By fostering such opportunities, companies can create new revenue opportunities, lower support costs and build much tighter customer relationships and loyalty.

Founded in 2009 and privately-held, Motomic is located in the Silicon Valley/San Francisco area.

To learn more, visit freescale.com/MotomicSoftware.



MSC Technologies GmbH

MSC Technologies, 25 years of business experience in embedded applications, superior design competency, specializes in the design and manufacturing of highly integrated standard board level products as well as customer specific boards and systems. All of our products can be easily tailored to satisfy requirements for volume OEM customers. The MSC portfolio offering includes modules and starter development kits based on the Freescale i.MX family of application processors.

Fully integrated R&D and manufacturing processes High volume OEM production capabilities. Excellent application and technology knowledge worldwide sales and support MSC Embedded is committed to provide the best possible solutions along with outstanding service to suit unique OEM customer requirements. MSC Technologies is an Avnet Company.

To learn more, visit freescale.com/MSCE.



NetModule

NetModule provides hardware and software engineering services and embedded systems for ARM-based CPUs (e.g., Kinetis MCUs/i.MX applications processors). NetModule supports MQX, Wind River VxWorks, Windows Embedded Compact and Embedded Linux. Apart from engineering services, NetModule offers off-the-shelf products, including the

i.MX processor-based SBCs with the related evaluation boards and SW drivers for IEC 62439 (PRP/HSR) for different platforms.

To learn more, visit freescale.com/NetModule.



Nexcom

Embedded Board Solutions Nexcom offers media appliances that interconnect to various types of media streams creating transparent end-to-end path for voice, video and data in corporations and service provider environments. Available in various functionality and sizes, these gateways may include premier bandwidth and codec optimization that reduce costs in the access and core portions of the network. Nexcom supplies a full suite of products ready to deliver video calls, text messaging and location-based services and many other high-demand

services over mobile, VoIP and traditional networks. Nexcom network appliances are suitable in SSL VPN, IDP/IPS, VoIP, IVR, Firewall, Web Filter and IMS. Additionally, Nexcom offers a full range of network security platforms designed to act as a solid foundation to host VPN as well as load balancing and in IDS/IPS. Nexcom's network security solutions provide highly secure platforms to ensure protect the operations of your business.

To learn more, visit freescale.com/Nexcom.



NovTech

NovTech was founded in 1998 to provide rapid system solutions to OEMs. Since then, NovTech has designed and provided more than 65 turn-key designs ranging from 8-bit MCUs, 32-bit MPU embedded systems and analog to ASIC development systems and FPGA-based designs. NovTech is experienced in high-speed, real-time, hardware, firmware and software design as well as PCB layout, prototyping and troubleshooting.

NovTech specializes in rapid prototyping and can deliver systems, from concept to production-grade prototypes, in as little as two-and-a-half weeks. Technology specializations: embedded computing (32-bit CPUs), microcontrollers, system-on-chip (SoC), PC peripherals, ISA, PCI, PC-Card, USB, IEEE 1394, communications, high-speed real-time control, imaging and encryption.

To learn more, visit freescale.com/NovTech.



OpenSynergy

RUNTIME SOFTWARE: APPLICATION SPECIFIC, MIDDLEWARE, OPERATING SYSTEM SOFTWARE

OpenSynergy is a specialist for embedded automotive software and the provider of COQOS, a software framework that supports Freescale i.MX application processors. COQOS contains the components necessary to efficiently create Android- and Linux-based telematics and infotainment systems that fulfill the requirements specific to automotive applications. OpenSynergy adapts its solutions to meet the specific needs of its customers by individually

assembling the modules in this flexible software kit. The most prominent components in COQOS are the certified hypervisor, the COQOS AUTOSAR environment, the shared graphics feature, the fast-booting rear-view camera, and the cross-domain Blue SDK (formerly an iAnywhere product). Our products enable the development of systems that meet the most demanding safety and security standards. OpenSynergy technology is deployed in millions

of devices and vehicles. Around the world, OpenSynergy provides its customers with fast, flexible product support and qualified engineering services.

To learn more, visit freescale.com/OpenSynergy.



O.S. Systems

SSI SERVICES | SW DEV TOOLS |
 RUNTIME SOFTWARE: APPLICATION SPECIFIC, MIDDLEWARE, OPERATING SYSTEM

The Yocto Project expertise is one of core competencies of O.S. Systems. The company is committed to providing best-in-class consultancy and services, enabling fast time-to-market for companies and partners on the development of their Linux-based projects.

O.S. Systems' objective is to provide complete satisfaction for its customers. Through experience and expertise acquired by its involvement in OpenEmbedded since 2008

and as one of the first companies to join the Yocto Project development effort in 2010, your project's requirements will be met.

Among the portfolio of services offered by O.S. Systems are development, customization and maintenance of board support packages (BSPs), Yocto Project workflow consulting and deployment, Qt project assistance, full project management and development, board farm automated test, and more.

O.S. Systems is very community-aware and is the Freescale's Yocto Project community BSP layer maintainer for the i.MX and QorIQ Layerscape architecture families.

To learn more, visit freescale.com/OSSystems.



P&E Microcomputer Systems

SW DEV TOOLS | HW DEV TOOLS

P&E Microcomputer Systems is an industry trendsetter in software and hardware development tools for Freescale microcontrollers. For Freescale Kinetis devices, P&E offers a variety of affordable, professional software. PROG for Cortex devices is in-circuit flash programming software that programs the target device in interactive or command-line modes via a P&E hardware interface.

P&E also partners with Freescale to provide drivers, applications and firmware updates for Freescale's OpenSDA debug/programming interface that helps users affordably evaluate Kinetis devices.

P&E's hardware tools are ideal for both product development and small- or large-scale production

programming. The Multilink Universal and high-speed Multilink Universal FX are all-in-one development interfaces that support many Freescale MCUs, including Kinetis. The Tracelink is a high-speed interface that, when used with Freescale CodeWarrior, can capture up to 128 MB of external trace on Kinetis and ColdFire devices. P&E's Cyclone MAX is a versatile, rugged production programmer that handles small or large production runs with ease. Control of one or more Cyclones can be completely automated, or they can be operated manually in standalone mode with no PC required. The Cyclone MAX supports several Freescale architectures, including Kinetis.

P&E hardware is supported by recent versions of CodeWarrior (10.x), current P&E software applications and toolchains from many Freescale partners, including IAR Systems, Keil, Cosmic Software, Atollic and Green Hills Software.

To learn more, visit freescale.com/PEMicro.



Pelagicore

Silicon manufacturers tell us about their frustration with products based on their hardware. Despite the latest silicon, performance is often not realized in software. We believe that a stunning user experience (UX) requires more than good hardware. It requires elaborate software architecture – from silicon to pixel.

At Pelagicore we feel great passion for design and for using Qt to develop a stunning UX. Our tools and products bridge the gap between

designers and developers. In automotive, PELUX® HeadUnit enables you to design and implement a head-unit that brings your customers closer to your brand – rock-solid and in-line with next generation mobile devices.

Open Source Software (OSS) such as Linux and Qt is at the core of everything we do. Through collaboration in communities and upstream projects we contribute to a more robust and secure code base. The Pelagicore initiated

Ethernet Audio Video Bridging (EAVB) project for example provides an OSS reference stack and enables innovative UX.

To learn more, visit freescale.com/Pelagicore.



PHYTEC

PHYTEC specializes in microprocessor-based solutions for mobile and embedded systems. For more than 25 years, it has delivered SoM subassemblies, rapid development kits, hardware and software design services, end-to-end life cycle management and systems integration expertise that have enabled development of thousands of innovative embedded products.

Its strategic alliance with Freescale enables PHYTEC to provide first-to-market SoM solutions supporting Vybrid controller solutions, i.MX 6 series processors and other processors that serve as CPU cores for embedded product development. End customers across a wide spectrum of industries, including automation and control, energy, medical and transportation, have made use of its complete portfolio of off-

the-shelf building blocks and services to shorten time to market, reduce development costs and avoid substantial design risks.

To learn more, visit freescale.com/PHYTEC.



Prevas Technologies

Prevas provides customer near development, utilizing highly specialized Centers of Excellence to solve complex niche tasks including complex carrier platforms, specialized development within EMC, audio, life science, industrial control, M2M connected devices, embedded OS or test systems. A fully supported hosted project management environment, including revision control, issue/requirement tracking and reporting is included with all projects—keeping the customer in control at all times.

Embedded Linux, Android and Windows Embedded

Prevas is an independent Embedded Linux BSP supplier for Industrial Embedded Linux and

customizes and maintains professional BSPs for all types of ARM solutions. For longevity, BSP maintenance for +10 years is a natural part of our Linux platform lifecycle.

Prevas also supplies customized Android BSPs for industrial use, including every step from BSP to application development.

Prevas' expertise in Windows Embedded ranges from boot loaders, BSPs and drivers to OS configuration, application development and testing. Prevas' experts within Windows Embedded are certified by Microsoft with access to authorized instructors.

Electronic Subsystem IP (ESIP)

Prevas' ESIP concept is a systematic breakdown of the carrier technologies into subsystems, which can be integrated into custom designs, supporting core technologies.

To learn more, visit freescale.com/PrevasTechnologies.



ProMik

ProMik is headquartered in Germany with local reach in all major regions of the globe.

Sourced by strong collaboration with the semiconductor industry, ProMik is one of the most innovative companies that offers Flash programming solutions for new devices well before its market introduction. ProMik is currently providing solutions around Freescale Kinetis MCUs.

All standardized interfaces like JTAG, SPI, BDM, I²C as well as bus protocols like LIN, CAN,

FlexRay and BroadR-Reach are supported.

Undivided attention is given to the Flash programming process that significantly determines customer's overall product quality, short-term and long-term. Results are fully recorded to track all steps of the programming process applied to the device.

To learn more, visit freescale.com/ProMik.



RealVNC

RealVNC has developed its VNC® remote access technology to create VNC Automotive, a solution that can automatically detect, access and control virtually any mobile device or desktop computer from a vehicle head unit or infotainment system either via MirrorLink™, iPod Out or VNC Automotive using USB, Wi-Fi and Bluetooth.

VNC Automotive is available as an OEM package for developers to integrate VNC technology within their own products.

The VNC Automotive SDK has been ported to all Freescale automotive chipsets and MirrorLink Certified on Freescale i.MX51 on Linux, Windows CE, QNX and Android. The SDK also supports other automotive operating systems and all leading mobile devices, including Windows Mobile, Symbian, Blackberry, iPhone and Android.

To learn more, visit freescale.com/RealVNC.



rt-labs

rt-labs is a software company specialized in embedded real-time systems for EtherCAT technology using Freescale Kinetis Microcontrollers. We provide products and solutions that enable our customers to reach the market quicker and decrease the maintenance cost over time. We help our clients develop

EtherCAT Masters and EtherCAT Slaves using our rt-labs EtherCAT SDK.

To learn more, visit freescale.com/rtlabs.

SW DEV TOOLS | IDH SERVICES | SSI SERVICES



Rightware

Automotive and mobile UI creation software

Rightware is a leading provider of high-performance, cross-platform UI technology for automotive, mobile and other embedded industries. Its Kanzi® UI solution is a complete package consisting of both PC-based, real-time UI creation software as well as a powerful 3D engine that enables immediate deployment of advanced UI on any devices that support OpenGL ES.

Kanzi UI technology has been successfully adopted by premium car manufacturers such as Audi AG and tier-1 suppliers such as Visteon. Its proven capability will continue to be validated in other markets, such as smartphones, tablets, smart TV and other embedded devices.

To learn more, visit freescale.com/Rightware.

SW DEV TOOLS



San Juan Software

San Juan Software has a proven track record of custom software development for ZigBee, RF4CE, the Internet of Things (IoT) and other Freescale wireless sensor and control networking such as MAC, SMAC and Synkro. Freescale turned to San Juan Software to collaborate on Freescale's BeeStack ZigBee stacks.

San Juan Software offers its own proprietary stack using Freescale components: PopNet is a full mesh networking stack for which it is much

easier to develop applications. A full application and the PopNet stack can fit in less than half the space and can take less than half the time to develop as compared with using ZigBee.

San Juan Software provides hands-on ZigBee technical training on the Freescale platform. We also offer custom on-site training to development teams.

To learn more, visit freescale.com/SanJuanSoftware.

SW DEV TOOLS | SSI SERVICES | TRAINING



SECO

SECO is a European designer and manufacturer of highly integrated systems and computer boards for embedded applications. Spanning its 30-plus years of experience, SECO has a proven ability to adapt its know-how to new, challenging customer needs and to provide its partners with cutting-edge solutions.

SECO's attention is focused on developing innovative products with high performance, low

power consumption and heat dissipation, low cost, increased functionality offering and a shorter time to market.

Thanks to innovative solutions, great research and design activities and to partnerships with major scientific universities and world-leading companies, SECO went international, becoming a global market leader that provides solutions to modern challenges.

To learn more, visit freescale.com/SECO.



SEGGER

RUNTIME SOFTWARE: MIDDLEWARE, OPERATING SYSTEMS | HW DEV TOOLS | SW DEV TOOLS

SEGGER Microcontroller develops hardware and software development tools specifically for embedded systems that support the Freescale i.MX application processors, Kinetis Microcontrollers and Vybrid controller solutions. We understand the needs and timelines of the modern embedded developer and mold our products around them with unparalleled performance and reliability.

SEGGER software products include embOS (RTOS), emWin (GUI), emFile (File System),

emUSB (USB Host and Device Stack), embOS/IP (TCP/IP Stack), emLib (Embedded Software Components including Encryption Algorithms) and emLoad (Boot Loader). These are all optimized for minimum memory usage, while achieving maximum performance.

SEGGER makes use of its own RTOS and middleware solutions to create highly integrated, cost effective, development and programming tools known as the industry leading J-Link/J-Trace family of debug probes

and the Flasher, a family of stand alone production flash programmers.

For more information visit, freescale.com/SEGGER.



Silex Technology

COMPANION SILICON AND MODULES | RUNTIME SOFTWARE: APPLICATION SPECIFIC, MIDDLEWARE, OPERATING SYSTEMS

Silex Technology offers single- and dual-band wireless solutions, including SDIO Modules and SDIO Systems-in-Packages (SiPs), all based on the proven Qualcomm® Atheros AR6003 chip technology.

Superior Technology

The Silex SX-SDCAN, a low-power SDIO form factor wireless radio module, was specifically designed for the Freescale i.MX 6 series. Built on the field-proven Qualcomm Atheros AR6003 802.11a/b/g/n radio, the SX-SDCAN is the only Freescale-recommended wireless connectivity solution for the i.MX 6 series.

Integrated Radio Software Support

Design engineers can easily implement Silex

Wi-Fi solutions with the Freescale i.MX 6 processor evaluation platforms, which include the Wi-Fi driver and security supplicant software. No engineering development is required to get started with your wireless evaluation.

Faster Time to Market

Silex Wi-Fi solutions are designed and validated to meet IEEE standards and have been modular certified to save regulatory costs. Silex can help customers streamline development processes and beat competitors to market.

The software is available for the following RTOS: Linux, Android, Green Hills Software INTEGRITY, Mentor Graphics Nucleus, QNX Neutrino and Windows Embedded Compact 7.

Silex Technology also provides engineering services to modify their software for customer-specific requirements. Whether it is porting to your target hardware platform or adding a custom feature, let them know your requirement and they will do their best to solve your problem.

To learn more, visit freescale.com/Silex.



Sohwa & Sophia Technologies

EMBEDDED BOARD SOLUTIONS

Sohwa & Sophia Technologies provides powerful and reliable real-time microprocessor emulation systems, reference platforms and other debug tools, enabling thousands of hardware and software engineers to complete their development projects on time and within budget. Sohwa & Sophia Technologies works closely

with semiconductor companies and other technology leaders to ensure its development and debugging solutions will overcome the most challenging embedded designs.

To learn more, visit freescale.com/SohwaSophia.



Symphony Teleca Corporation

Symphony Teleca Corporation, headquartered in Palo Alto, Calif., is the world's first services company dedicated exclusively to helping clients manage the global convergence of software, the cloud and connected devices. The company delivers innovative products combined with contemporary product development, systems integration, analytics and managed services to

hundreds of organizations around the world. Symphony Teleca's 6,100 employees support customers from 35 offices globally, including delivery centers in Asia, Australia, Europe and the Americas. With over 500 man-years of experience, Symphony Teleca is providing complete product engineering services for Mobile and Connected devices. We offer all the building blocks for quick

and cost-efficient product development from concept to product launch and beyond.

To learn more, visit freescale.com/SymphonyTeleca.



SYSGO

SYSGO provides OS technology, middleware, and software services for the real-time and embedded market. A differentiating capability of SYSGO is the SSV (Safe and Secure Virtualization) product PikeOS™, a paravirtualization OS which is built upon a small, fast, safe and secure microkernel onto Freescale i.MX application processors. It supports the co-existence of independent OS personalities on a single platform, including ELinOS, SYSGO's embedded Linux distribution.

SYSGO supports international customers with services for embedded Linux, real-time capabilities and certification for safety-critical applications. Markets include Aerospace & Defense, Industrial Automation, Automotive, Railway, Medical, Smart Energy and Security. Customers include Airbus, Thales, Continental, Raytheon, Samsung, Rheinmetall, Rockwell-Collins, B. Braun, Miele and Rohde & Schwarz. SYSGO has facilities in Germany, France, The

Czech Republic, UK and North America, and offers a global distribution and support network, including Europe and the Pacific Rim.

To learn more, visit freescale.com/sysgo.



TechNexion

As a leading embedded solution provider, TechNexion designs and manufactures cutting-edge computing systems. Backed by experienced engineers and product specialists, its expertise is focused on creating and testing embedded systems that can be applied to networking security, factory automation, medical care equipment, media streaming applications and other industrial fields. TechNexion manufactures board level, system level and fully integrated industrial computer

products for OEMs and end users who seek to automate their applications quickly and cost-effectively. They have a simple goal: to be your industrial computer solution supplier. TechNexion is dedicated to providing you with a single source for your industrial PC needs—from its chassis for harsh industrial environments to its systems integration service, engineering support, customizing of industrial PCs and customer service. TechNexion attributes its success to its business ethics,

strategy, planning and implementation, which are considered the most important piece of TechNexion's unprecedented growth.

To learn more, visit freescale.com/TechNexion.



Timesys

Timesys is an embedded Linux solution pioneer committed to providing easy-to-use embedded Linux offerings with world-class support, professional services and training to embedded developers using Linux as their go-to-market platform.

LinuxLink is a complete and flexible suite of tools for embedded Linux platform and application development teams. Available for the popular ARM-based Freescale i.MX applications processors and Vybrid controller solutions, LinuxLink combines an innovative build system, software repository, comprehensive suite of development tools for building feature-rich applications and debugging, and expert support to enable developers to

deliver high-quality, differentiated embedded Linux products in a cost-effective and timely manner.

Embedded Linux and Android Professional Services

Timesys has an international customer base and proven record of successful Professional Services projects and deployments in markets, including industrial control/process automation, medical, automotive, telecommunications, networking, consumer electronics and military/aerospace. In addition, Timesys has extensive experience with Linux kernel and subsystem development, device driver development, board bring up, industrial buses and system optimization, including fast boot and power management.

Embedded Linux Software and Solutions Integrator Services

Timesys SSI Services offer product evaluation, design and integration and include OS integration (RTOS + Linux), HMI design, development and optimization, third-party and open-source software integration (e.g., Qt, GStreamer, Java™, OpenGL, proprietary, etc.), camera integration and Android design and development.

To learn more, visit freescale.com/Timesys.



Toradex

Toradex specializes in designing and delivering ARM based computer modules for the embedded market including modules based on the Freescale i.MX processor and Vybrid controller families. Their Hardware and Software offer unmatched configurability and hence enables quick and cost-effective concepts to transform into successful products.

The small form factor and ultra-low power consumption make our modules very well suited for rugged and mobile applications, while at

the same time providing high performance computing and graphical power.

Direct customer support provided by their development engineers as well as a wealth of free reference designs, software tools and libraries massively speeds up your development time and - at the same time - reduces your development risk.

Furthermore Toradex frees up your resources: by deploying our computer modules you do not have to worry about hardware changes or

software bugs in the operating system. Their products come with free product maintenance for their entire life cycle.

For more information visit, freescale.com/Toradex.



EMBEDDED BOARD SOLUTIONS

TQ-Components

The TQ-Group is leading in 16-, 32- and 64-bit embedded systems. The TQ-Group has a wealth of experience in design and production of leading MCU/MPU systems specializing in industrial applications. TQ's product offerings supporting Freescale's ARM-based architectures are all supported with embedded modules, starter kits and complete systems like industrial terminals. This wide offering helps customers

develop a variety of system solutions and provides an excellent core for applications in entertainment, human-machine interfaces and industrial control.

To learn more, visit freescale.com/TQ.



RUNTIME SOFTWARE: APPLICATION SPECIFIC, MIDDLEWARE, OPERATING SYSTEMS

Ubiquitous Corporation

Ubiquitous was established with the aim of realizing the dream of ubiquitous networks for connecting the various devices that we constantly use today so seamlessly that we need not even think about it making connections. Compact, efficient and high-speed software is indispensable to the creation of such ubiquitous networks, and Ubiquitous is committed to contributing to this endeavor through developing the world's most compact, efficient and high-speed network, database software and Linux/Android fast boot solution.

Ubiquitous Network Framework is a software platform to develop ubiquitous network devices with a very small amount of resources.

DeviceSQL is a next-generation data management framework software (device data management) product specialized for embedded systems.

QuickBoot can deliver rapid boot times to any device - no more waiting for your device to power up. QuickBoot utilizes advanced technology to nearly instantaneously bring your device back to life from a complete power down state.

To learn more, visit freescale.com/Ubiquitous.



EMBEDDED BOARD SOLUTIONS | IDH SERVICES

Variscite

Variscite is a leading manufacturer of a variety of System-On-Modules, including modules based on the Freescale i.MX family of application processors. Variscite's SOMs are ideal for low power, high performance and cost sensitive products. Variscite's SOMs support Android, Windows CE and Embedded Linux and are ready to be integrated into any embedded solution.

Variscite services span across both hardware and software design, including custom carrier boards and software development required by the customer's specific products.

To learn more, visit freescale.com/Variscite.



Vector Informatik

Vector is the leading producer of software tools and components for networking in electronic systems based on CAN, LIN, FlexRay, Automotive Ethernet and a number of CAN-based protocols. With over 25-years of experience working with automotive OEMs and suppliers of electronic ECUs Vector expertise continues to enhance ECU software components, ECU analysis and testing, ECU calibration, Diagnostics and network architecture.

Founded in 1988, Vector Informatik is headquartered in Stuttgart, Germany. Vector also operates subsidiaries in the USA, Japan, France, Sweden, Republic of Korea, China, UK, Italy and Brasil.

Vector is actively involved in standardization activities such as AUTOSAR / CANopen and fully supports Freescale i.MX application processors and Vybrid controller solutions.

To learn more, visit freescale.com/VectorInformatik.



(Guangzhou) ZLG MCU Technology Co., Ltd

Guangzhou ZLG MCU Technology Co., Ltd. elected as one of the top eight distributors in CHINA provides MCU based embedded systems as well as professional engineering and design services. ZLG solutions and services can be found in automotive electronics, industrial application, power instruments, communication, security systems, and consumer electronics application markets. The company has a reliable and wide range of customers in all of the above markets across China.

In 2014, ZLG introduced the EasyARM-iMX283 industrial grade embedded module with support for Windows Embedded CE and Linux OS. The modules hardware and software sources open a new horizon for users of the Freescale i.MX28 processor family in the Chinese market.

To learn more, visit freescale.com/ZLG.



Embedded Board Solutions (EBS)

OEMs are faced with the increasing challenge of bringing innovative products to market quicker while balancing more complex solution requirements and limited resources. Additionally, technical device needs for many markets are continually being redefined with trends like embedding human-machine interfaces (HMI), machine-to-machine (M2M) technology and enabling portability and communication, forcing OEMs to step back and decide between “make vs. buy.”

Through a strong ecosystem of EBS-proven partners, Freescale offers a full range of embedded board solutions with a spectrum of form factors, processors, features and software enablement tools. These ready-for-production solutions help ease the make vs. buy decision, allowing OEMs to focus on full system integration and software.

EBS: Your Ready-for-Production Solution

Freescale’s EBS partners offer a range of boards with different form factors, such as Qseven, Arduino, COM Express®, SMARC, VPX and EBX. These boards—many of which feature Freescale’s Kinetis MCUs, i.MX applications processors, QorIQ communications processors and Vybrid controller solutions—help OEMs kick-start their designs, helping them speed time to market by addressing resource constraints, hardware complexity and new market challenges.

Our EBS partners’ solutions support Freescale’s product longevity standards of 10 years, 15 years and beyond. They also offer qualified consumer, industrial, medical, aerospace and defense solutions supported by development tools, technical expertise and flexible manufacturing.

Offering Standard to Custom Form Factors



Embedded Board Solutions Enablement

Freescale has long-standing relationships within the embedded board industry. We serve the same markets, including industrial, aerospace and defense, medical and consumer. However, our support for these markets is not in silicon alone. A close working relationship with OS and tool vendors is essential to ensure our customers have access to complete solutions that enable them to achieve their time-to-market goals. Our system integrators provide Linux-, WinCE®, Android OS- and QNX-matching multimarket requirements.

As a company, Freescale continues to demonstrate its commitment to the embedded market through programs such as the EBS co-selling program, focused on innovating solutions to continue to ease challenges facing OEMs.

More Information

The Freescale Connect Program highlights our ecosystem partners, including Proven Embedded Board Partners that provide a complete spectrum of solutions and supporting software.

To learn more, visit freescale.com/EBS.



For more information about Freescale ARM products and documentation, please visit freescale.com/Kinetis, freescale.com/iMX, freescale.com/QorIQ, freescale.com/Vybrid and freescale.com/ARM

Freescale, the Freescale logo, CodeWarrior, ColdFire, Kinetis, PEG, Processor Expert and QorIQ are trademarks of Freescale Semiconductor, Inc., Reg. U.S. Pat. & Tm. Off. Layerscape, QUICC Engine, Tower, Vybrid and Xtrinsic are trademarks of Freescale Semiconductor, Inc. ARM is the registered trademark of ARM Limited. ARM9, ARM11, ARM926EJS, ARMv7, Cortex-A5, Cortex-A7, Cortex-A8, Cortex-A9, Cortex-M, Cortex-M0+, Cortex-M3, Cortex-M4, DS-5, CoreSight, DSTREAM, NEON and TrustZone are trademarks of ARM Limited. Java and all other Java-based marks are trademarks or registered trademarks of Sun Microsystems, Inc. in the U.S. and other countries. The Power Architecture and **Power.org** word marks and the Power and **Power.org** logos and related marks are trademarks and service marks licensed by **Power.org**. All other product or service names are the property of their respective owners. © 2010–2014 Freescale Semiconductor, Inc.



Looking for pricing, stock, or lifecycle information?

Click below to explore more details on WIN SOURCE:

 [View MKL36Z256VLH4 on WIN SOURCE](#)

 [NXP / Nexperia Information](#)

Optimize Your Supply Chain with WIN SOURCE Solutions

-  Global Sourcing Solution
-  Obsolete Management
-  Cost Control Management
-  Shortage Management
-  Alternative Solution
-  Excess Inventory Management