



**THE DATASHEET OF
MRF5S4140HR3**



RF Power Field Effect Transistors

N-Channel Enhancement-Mode Lateral MOSFETs

Designed for broadband commercial and industrial applications with frequencies from 400 to 500 MHz. The high gain and broadband performance of these devices make them ideal for large-signal, common-source amplifier applications in 28-volt base station equipment.

- Typical Single-Carrier N-CDMA Performance @ 465 MHz: $V_{DD} = 28$ Volts, $I_{DQ} = 1250$ mA, $P_{out} = 28$ Watts Avg., IS-95 CDMA (Pilot, Sync, Paging, Traffic Codes 8 Through 13). Channel Bandwidth = 1.2288 MHz. PAR = 9.8 dB @ 0.01% Probability on CCDF.
Power Gain — 21 dB
Drain Efficiency — 30%
ACPR @ 750 kHz Offset — -47.6 dBc in 30 kHz Bandwidth
- Capable of Handling 10:1 VSWR, @ 28 Vdc, 465 MHz, 140 Watts CW Output Power

Features

- Characterized with Series Equivalent Large-Signal Impedance Parameters
- Internally Matched for Ease of Use
- Qualified Up to a Maximum of 32 V_{DD} Operation
- Integrated ESD Protection
- Lower Thermal Resistance Package
- Low Gold Plating Thickness on Leads, 40 μ ” Nominal.
- RoHS Compliant
- In Tape and Reel. R3 Suffix = 250 Units per 56 mm, 13 inch Reel.

MRF5S4140HR3
MRF5S4140HSR3

465 MHz, 28 W AVG., 28 V
SINGLE N-CDMA
LATERAL N-CHANNEL
RF POWER MOSFETs

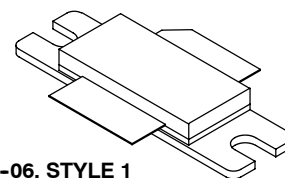

CASE 465-06, STYLE 1
NI-780
MRF5S4140HR3

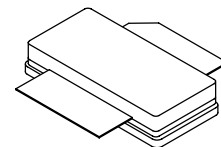

CASE 465A-06, STYLE 1
NI-780S
MRF5S4140HSR3

ARCHIVE INFORMATION

ARCHIVE INFORMATION

Table 1. Maximum Ratings

Rating	Symbol	Value	Unit
Drain-Source Voltage	V_{DSS}	-0.5, +65	Vdc
Gate-Source Voltage	V_{GS}	-0.5, +15	Vdc
Total Device Dissipation @ $T_C = 25^\circ\text{C}$ Derate above 25 $^\circ\text{C}$	P_D	427 2.4	W W/ $^\circ\text{C}$
Storage Temperature Range	T_{stg}	-65 to +150	$^\circ\text{C}$
Case Operating Temperature	T_C	150	$^\circ\text{C}$
Operating Junction Temperature	T_J	200	$^\circ\text{C}$

Table 2. Thermal Characteristics

Characteristic	Symbol	Value (1,2)	Unit
Thermal Resistance, Junction to Case Case Temperature 73 $^\circ\text{C}$, 140 W CW Case Temperature 74 $^\circ\text{C}$, 28 W CW	$R_{\theta JC}$	0.41 0.47	$^\circ\text{C}/\text{W}$

1. MTTF calculator available at <http://www.freescale.com/rf>. Select Tools/Software/Application Software/Calculators to access the MTTF calculators by product.
2. Refer to AN1955, *Thermal Measurement Methodology of RF Power Amplifiers*. Go to <http://www.freescale.com/rf>. Select Documentation/Application Notes - AN1955.

Table 3. ESD Protection Characteristics

Test Methodology	Class
Human Body Model (per JESD22-A114)	2 (Minimum)
Machine Model (per EIA/JESD22-A115)	A (Minimum)
Charge Device Model (per JESD22-C101)	IV (Minimum)

Table 4. Electrical Characteristics ($T_C = 25^\circ\text{C}$ unless otherwise noted)

Characteristic	Symbol	Min	Typ	Max	Unit
----------------	--------	-----	-----	-----	------

Off Characteristics

Zero Gate Voltage Drain Leakage Current ($V_{DS} = 65\text{ Vdc}$, $V_{GS} = 0\text{ Vdc}$)	I_{DSS}	—	—	10	μAdc
Zero Gate Voltage Drain Leakage Current ($V_{DS} = 28\text{ Vdc}$, $V_{GS} = 0\text{ Vdc}$)	I_{DSS}	—	—	1	μAdc
Gate-Source Leakage Current ($V_{GS} = 5\text{ Vdc}$, $V_{DS} = 0\text{ Vdc}$)	I_{GSS}	—	—	1	μAdc

On Characteristics

Gate Threshold Voltage ($V_{DS} = 10\text{ Vdc}$, $I_D = 400\ \mu\text{Adc}$)	$V_{GS(th)}$	2	3	4	Vdc
Gate Quiescent Voltage ($V_{DS} = 28\text{ Vdc}$, $I_D = 1250\text{ mAdc}$, Measured in Functional Test)	$V_{GS(Q)}$	3	4	5	Vdc
Drain-Source On-Voltage ($V_{GS} = 10\text{ Vdc}$, $I_D = 2.42\text{ Adc}$)	$V_{DS(on)}$	0.1	0.2	0.3	Vdc
Forward Transconductance ($V_{DS} = 10\text{ Vdc}$, $I_D = 3\text{ Adc}$)	g_{fs}	—	6.2	—	S

Dynamic Characteristics (1)

Reverse Transfer Capacitance ($V_{DS} = 28\text{ Vdc} \pm 30\text{ mV(rms)ac}$ @ 1 MHz, $V_{GS} = 0\text{ Vdc}$)	C_{rss}	—	2.3	—	pF
---	-----------	---	-----	---	----

Functional Tests (In Freescale Test Fixture, 50 ohm system) $V_{DD} = 28\text{ Vdc}$, $I_{DQ} = 1250\text{ mA}$, $P_{out} = 28\text{ W Avg. N-CDMA}$, $f = 465\text{ MHz}$, Single-Carrier N-CDMA, 1.2288 MHz Channel Bandwidth Carrier. ACPR measured in 30 kHz Channel Bandwidth @ $\pm 750\text{ kHz}$ Offset. PAR = 9.8 dB @ 0.01% Probability on CCDF.

Power Gain	G_{ps}	20	21	23	dB
Drain Efficiency	η_D	28.5	30	—	%
Adjacent Channel Power Ratio	ACPR	—	-47.6	-45	dBc
Input Return Loss	IRL	—	-14	-9	dB

1. Part internally input matched.

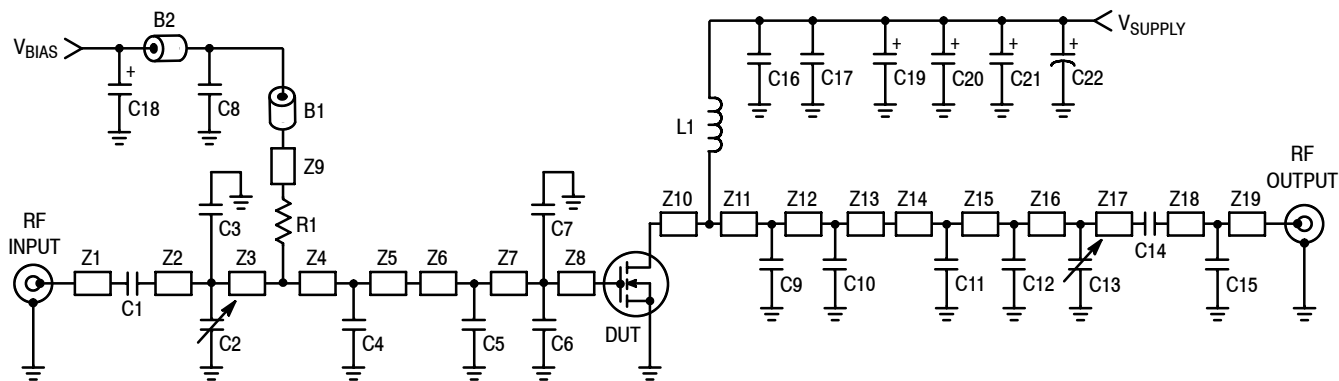

Z1	0.402" x 0.080" Microstrip	Z11	0.125" x 0.220" Microstrip
Z2	1.266" x 0.080" Microstrip	Z12	0.324" x 0.220" Microstrip
Z3	0.211" x 0.220" Microstrip	Z13	0.050" x 0.220" Microstrip
Z4	0.139" x 0.220" Microstrip	Z14	0.171" x 0.080" Microstrip
Z5	0.239" x 0.220" Microstrip	Z15	0.377" x 0.080" Microstrip
Z6	0.040" x 0.640" Microstrip	Z16	0.358" x 0.080" Microstrip
Z7	0.080" x 0.640" Microstrip	Z17	0.361" x 0.080" Microstrip
Z8	0.276" x 0.640" Microstrip	Z18	0.131" x 0.080" Microstrip
Z9	1.000" x 0.226" Microstrip	Z19	0.277" x 0.080" Microstrip
Z10	0.498" x 0.630" Microstrip	PCB	Arlon GX-0300-55-22, 0.030", $\epsilon_r = 2.55$

Figure 1. MRF5S4140HR3(SR3) Test Circuit Schematic — 460-470 MHz

Table 5. MRF5S4140HR3(SR3) Test Circuit Component Designations and Values — 460-470 MHz

Part	Description	Part Number	Manufacturer
B1, B2	Ferrite Beads, Short	2743019447	Fair-Rite
C1, C14	120 pF Chip Capacitors	100B121JP500X	ATC
C2, C13	0.8-8.0 pF Variable Capacitors, Gigatrim	27291SL	Johanson
C3	18 pF Chip Capacitor	100B180JP500X	ATC
C4	30 pF Chip Capacitor	100B300JP500X	ATC
C5	24 pF Chip Capacitor	100B240JP500X	ATC
C6, C7	13 pF Chip Capacitors	100B130JP500X	ATC
C8	0.02 μ F, 50 V Chip Capacitor	200B203MW50B	ATC
C9, C10	22 pF Chip Capacitors	100B220JP500X	ATC
C11	1.0 pF Chip Capacitor	100B1R0JP500X	ATC
C12	5.6 pF Chip Capacitor	100B5R6JP500X	ATC
C15	1.5 pF Chip Capacitor	100B1R5JP500X	ATC
C16	47 pF Chip Capacitor	100B47JP500X	ATC
C17	0.56 μ F, 50 V Chip Capacitor	C1825C564J5GAC	Kemet
C18, C19, C20, C21	10 μ F, 35 V Tantalum Chip Capacitors	T491D106K035AS	Kemet
C22	470 μ F, 63 V Electrolytic Capacitor	SME63V471M12X25LL	United Chemi-Con
L1	39 nH Inductor	1812SMS-39N	Coilcraft
R1	100 Ω , 1/4 W Chip Resistor (1210)		

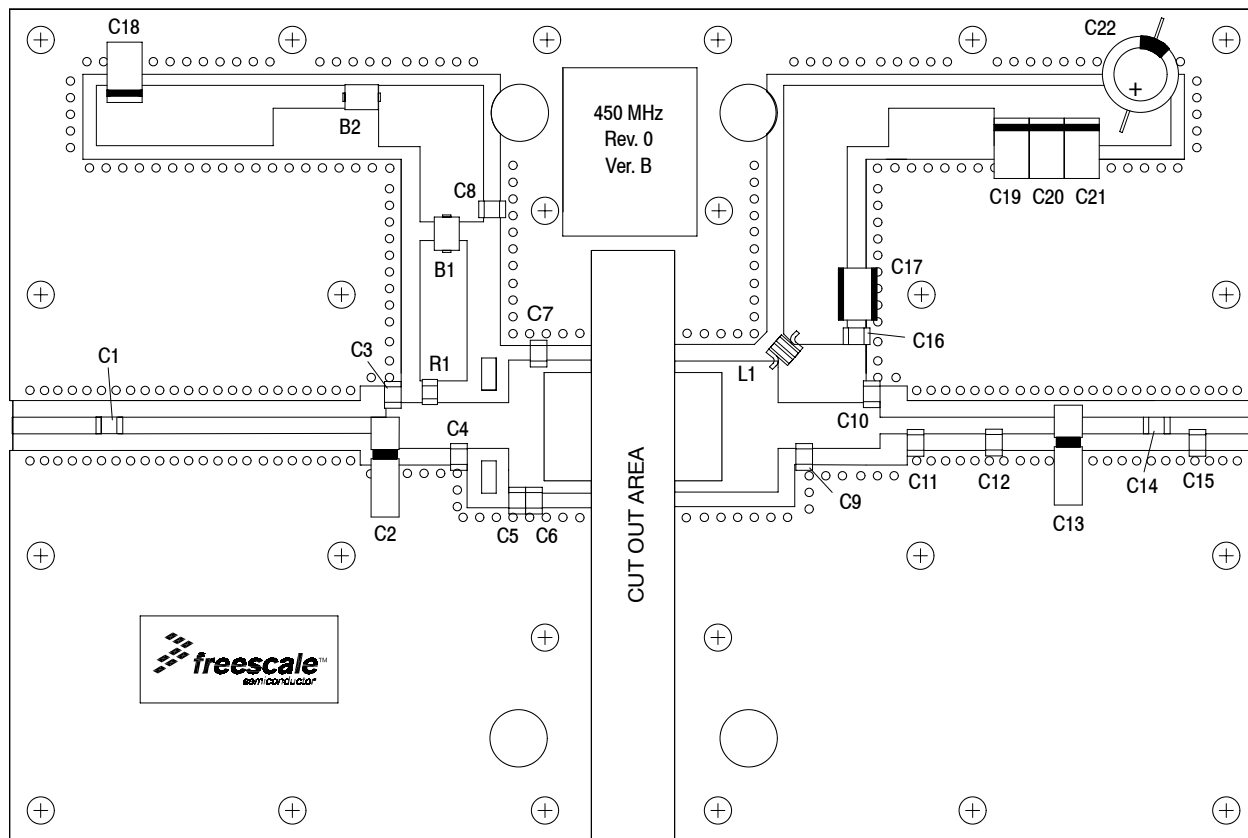

Figure 2. MRF5S4140HR3(SR3) Test Circuit Component Layout — 460-470 MHz

ARCHIVE INFORMATION

ARCHIVE INFORMATION

TYPICAL CHARACTERISTICS — 460-470 MHz

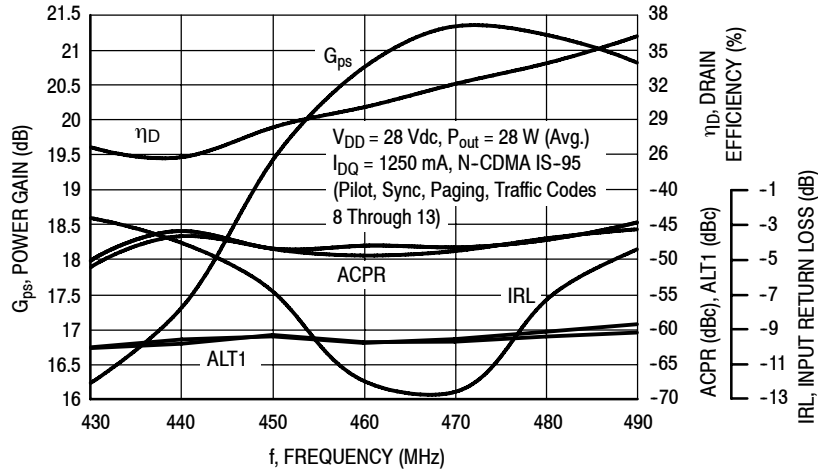

Figure 3. Single-Carrier N-CDMA Broadband Performance @ $P_{out} = 28$ Watts Avg.

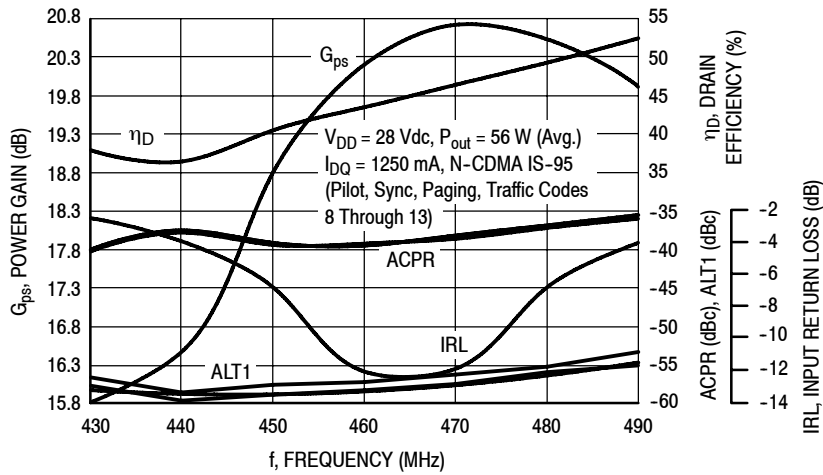

Figure 4. Single-Carrier N-CDMA Broadband Performance @ $P_{out} = 56$ Watts Avg.

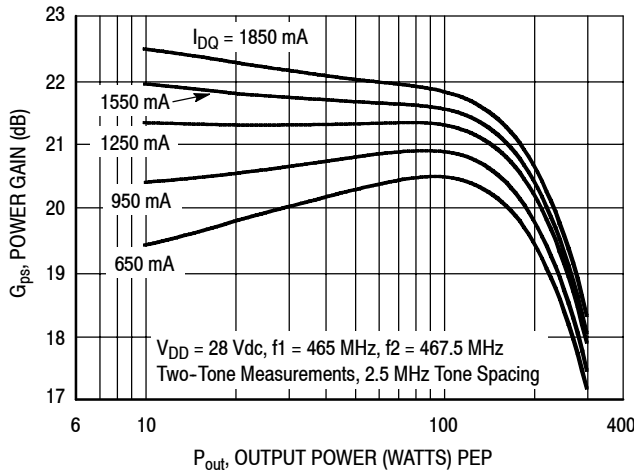

Figure 5. Two-Tone Power Gain versus Output Power

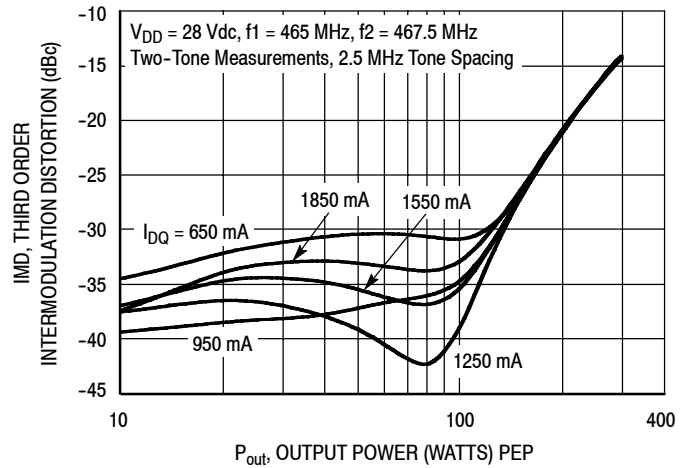

Figure 6. Third Order Intermodulation Distortion versus Output Power

TYPICAL CHARACTERISTICS — 460-470 MHz

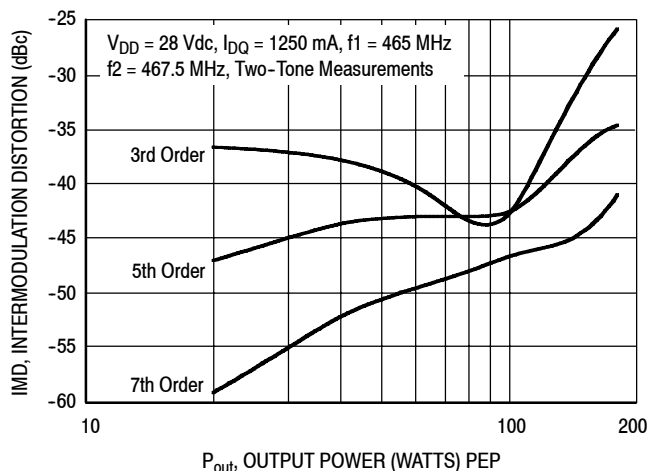

Figure 7. Intermodulation Distortion Products versus Output Power

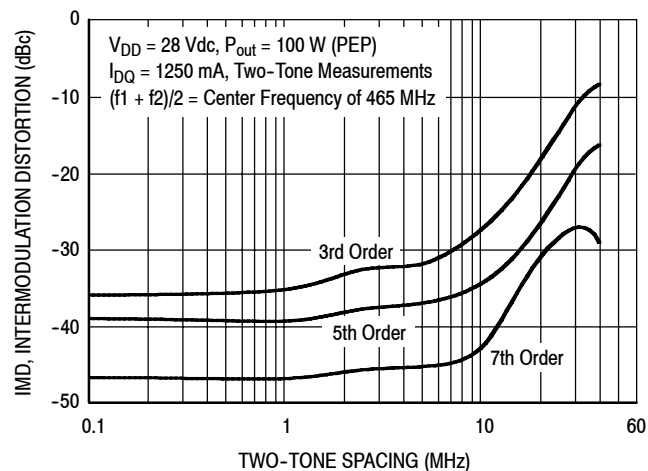

Figure 8. Intermodulation Distortion Products versus Tone Spacing

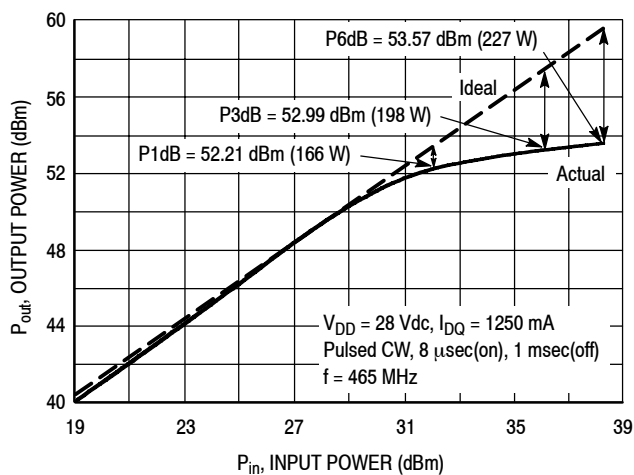

Figure 9. Pulse CW Output Power versus Input Power

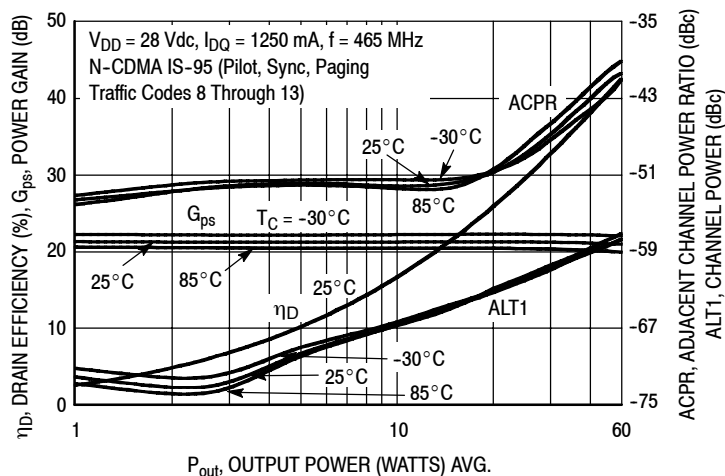

Figure 10. Single-Carrier N-CDMA ACPR, ALT1, Power Gain and Drain Efficiency versus Output Power

ARCHIVE INFORMATION

ARCHIVE INFORMATION

TYPICAL CHARACTERISTICS — 460-470 MHz

ARCHIVE INFORMATION

ARCHIVE INFORMATION

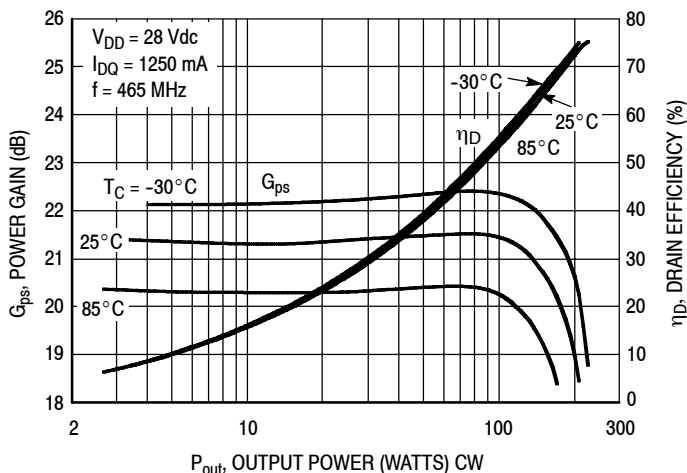

Figure 11. Power Gain and Drain Efficiency versus CW Output Power

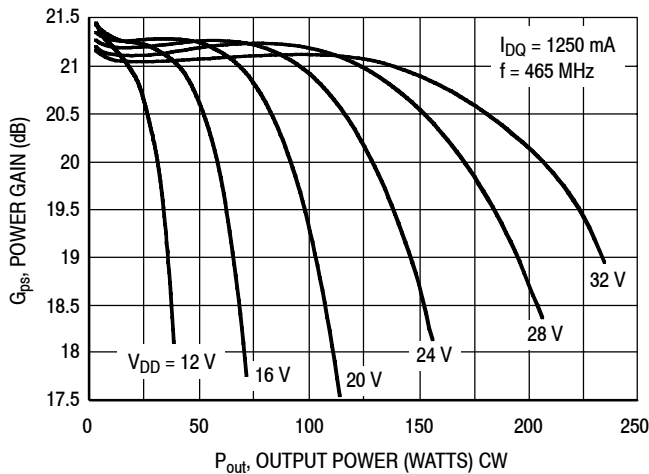
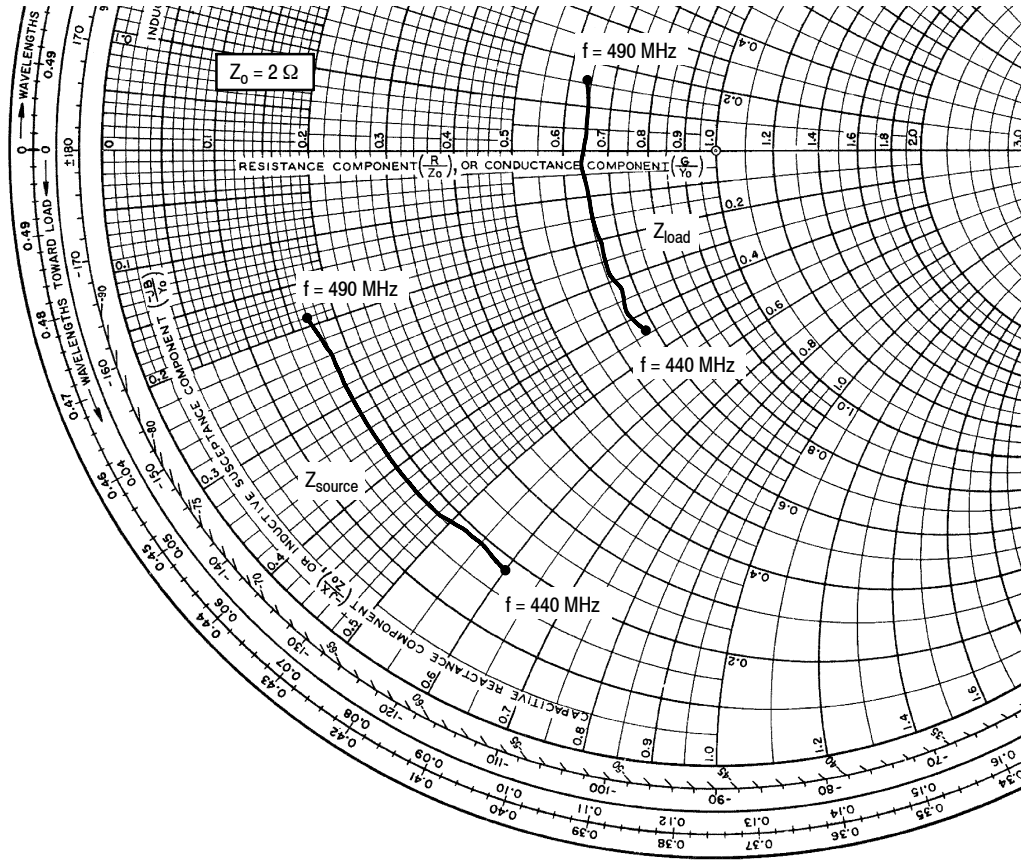

Figure 12. Power Gain versus Output Power



$V_{DD} = 28 \text{ Vdc}$, $I_{DQ} = 1250 \text{ mA}$, $P_{out} = 28 \text{ W Avg.}$

f MHz	Z_{source} Ω	Z_{load} Ω
440	$0.359 - j1.19$	$1.35 - j0.870$
445	$0.389 - j1.11$	$1.31 - j0.743$
450	$0.379 - j1.03$	$1.34 - j0.641$
455	$0.360 - j0.959$	$1.32 - j0.539$
460	$0.355 - j0.873$	$1.31 - j0.420$
465	$0.352 - j0.773$	$1.30 - j0.274$
470	$0.350 - j0.710$	$1.29 - j0.173$
475	$0.350 - j0.628$	$1.28 - j0.044$
480	$0.356 - j0.540$	$1.29 + j0.090$
485	$0.355 - j0.473$	$1.29 + j0.195$
490	$0.345 - j0.388$	$1.28 + j0.313$

Z_{source} = Test circuit impedance as measured from gate to ground.

Z_{load} = Test circuit impedance as measured from drain to ground.

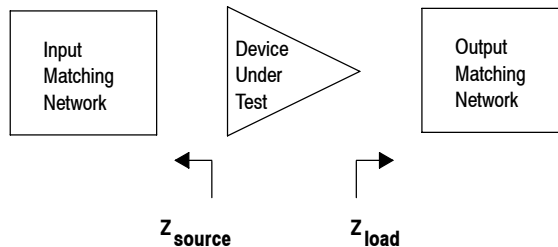
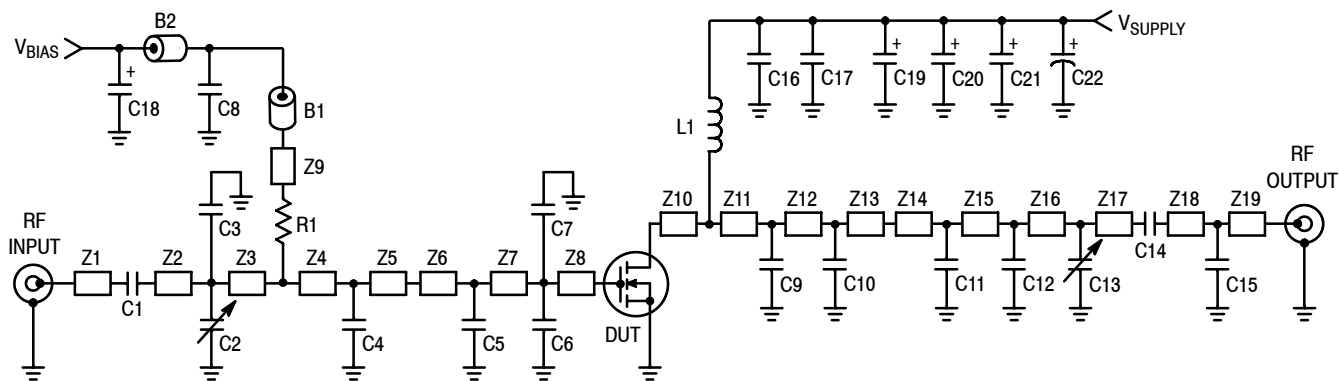

Figure 13. Series Equivalent Source and Load Impedance — 460-470 MHz



Z1	0.402" x 0.080" Microstrip	Z11	0.125" x 0.220" Microstrip
Z2	1.266" x 0.080" Microstrip	Z12	0.324" x 0.220" Microstrip
Z3	0.211" x 0.220" Microstrip	Z13	0.050" x 0.220" Microstrip
Z4	0.139" x 0.220" Microstrip	Z14	0.171" x 0.080" Microstrip
Z5	0.239" x 0.220" Microstrip	Z15	0.377" x 0.080" Microstrip
Z6	0.040" x 0.640" Microstrip	Z16	0.358" x 0.080" Microstrip
Z7	0.080" x 0.640" Microstrip	Z17	0.361" x 0.080" Microstrip
Z8	0.276" x 0.640" Microstrip	Z18	0.131" x 0.080" Microstrip
Z9	1.000" x 0.226" Microstrip	Z19	0.277" x 0.080" Microstrip
Z10	0.498" x 0.630" Microstrip	PCB	Arlon GX-0300-55-22, 0.030", $\epsilon_r = 2.55$

Figure 14. MRF5S4140HR3(SR3) Test Circuit Schematic — 420-430 MHz

Table 6. MRF5S4140HR3(SR3) Test Circuit Component Designations and Values — 420-430 MHz

Part	Description	Part Number	Manufacturer
B1, B2	Ferrite Beads, Short	2743019447	Fair-Rite
C1, C14	120 pF Chip Capacitors	100B121JP500X	ATC
C2, C13	0.8-8.0 pF Variable Capacitors, Gigatrim	27291SL	Johanson
C3	18 pF Chip Capacitor	100B180JP500X	ATC
C4	39 pF Chip Capacitor	100B390JP500X	ATC
C5	24 pF Chip Capacitor	100B240JP500X	ATC
C6, C7	13 pF Chip Capacitors	100B130JP500X	ATC
C8	0.02 μ F, 50 V Chip Capacitor	200B203MW50B	ATC
C9, C10	22 pF Chip Capacitors	100B220JP500X	ATC
C11	1.0 pF Chip Capacitor	100B1R0JP500X	ATC
C12	5.6 pF Chip Capacitor	100B5R6JP500X	ATC
C15	1.5 pF Chip Capacitor	100B1R5JP500X	ATC
C16	47 pF Chip Capacitor	100B47JP500X	ATC
C17	0.56 μ F, 50 V Chip Capacitor	C1825C564J5GAC	Kemet
C18, C19, C20, C21	10 μ F, 35 V Tantalum Chip Capacitors	T491D106K035AS	Kemet
C22	470 μ F, 63 V Electrolytic Capacitor	SME63V471M12X25LL	United Chemi-Con
L1	39 nH Inductor	1812SMS-39N	Coilcraft
R1	100 Ω , 1/4 W Chip Resistor (1210)		

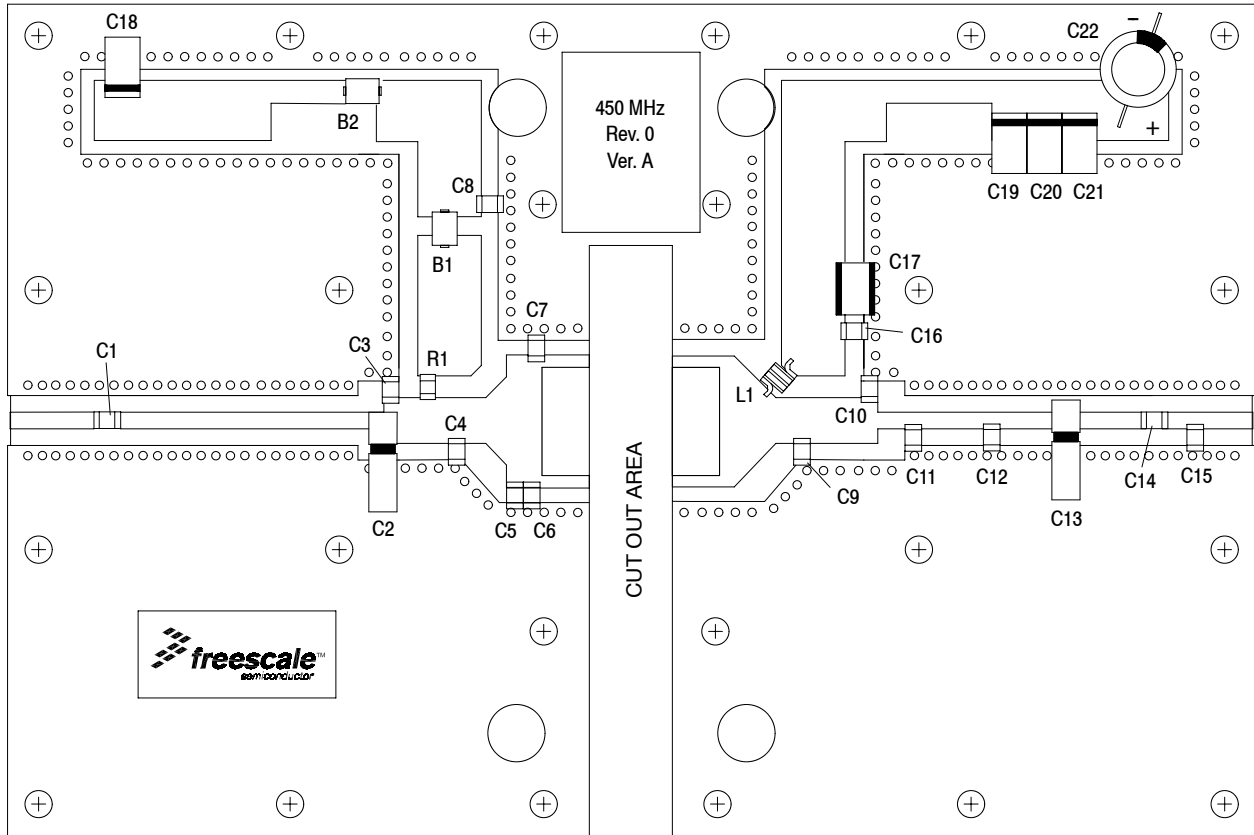

Figure 15. MRF5S4140HR3(SR3) Test Circuit Component Layout — 420-430 MHz

ARCHIVE INFORMATION

ARCHIVE INFORMATION

TYPICAL CHARACTERISTICS — 420-430 MHz

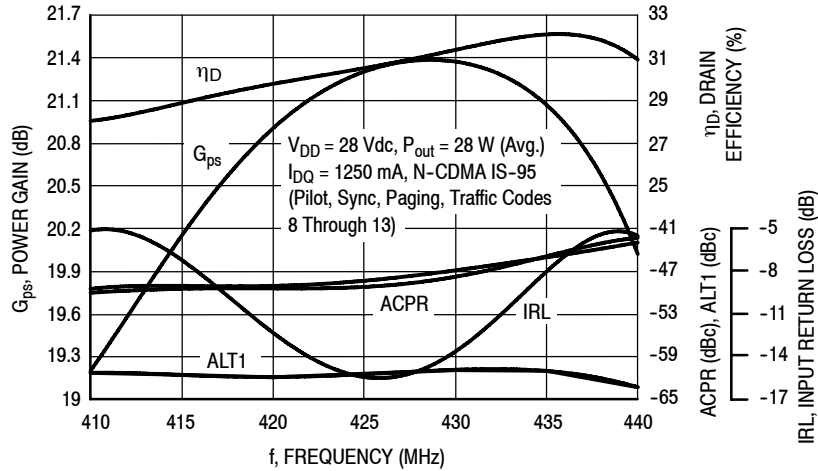

Figure 16. Single-Carrier N-CDMA Broadband Performance @ $P_{out} = 28$ Watts Avg.

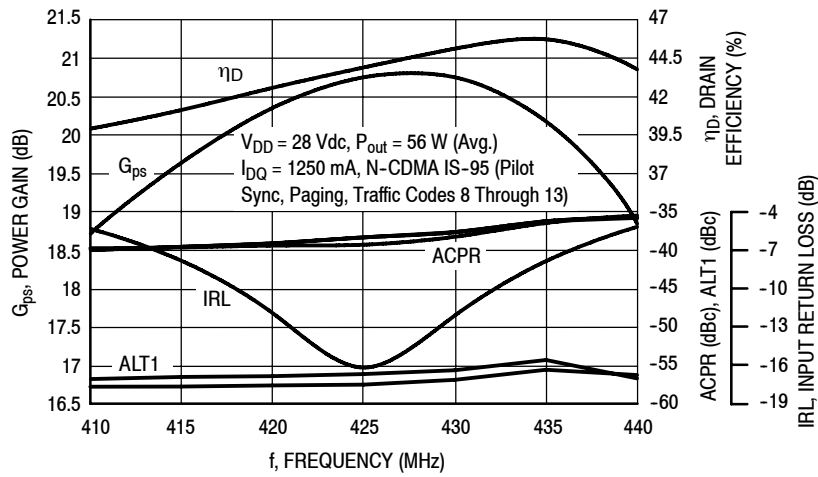
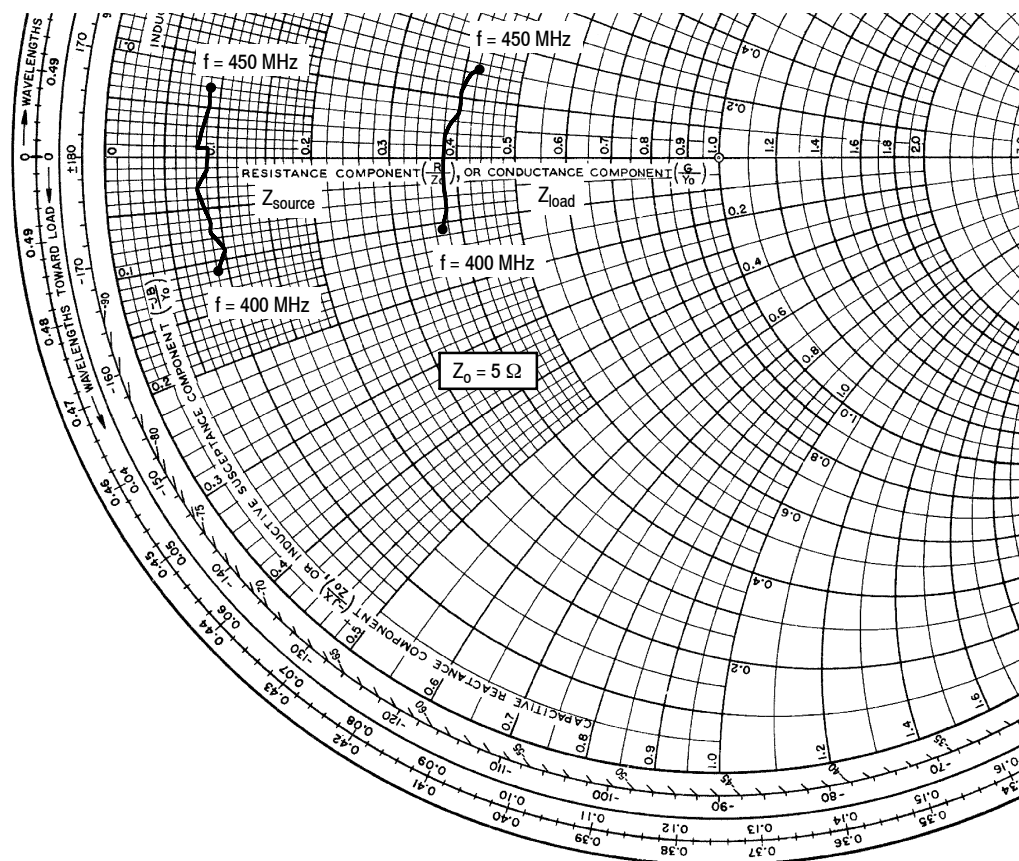

Figure 17. Single-Carrier N-CDMA Broadband Performance @ $P_{out} = 56$ Watts Avg.

ARCHIVE INFORMATION

ARCHIVE INFORMATION



$V_{DD} = 28 \text{ Vdc}$, $I_{DQ} = 1250 \text{ mA}$, $P_{out} = 28 \text{ W Avg.}$

f MHz	Z_{source} Ω	Z_{load} Ω
400	$0.454 - j0.530$	$1.87 - j0.530$
405	$0.476 - j0.435$	$1.91 - j0.376$
410	$0.430 - j0.360$	$1.88 - j0.276$
415	$0.455 - j0.281$	$1.91 - j0.046$
420	$0.419 - j0.153$	$1.89 - j0.019$
425	$0.421 - j0.135$	$1.92 + j0.128$
430	$0.435 - j0.032$	$1.97 + j0.276$
435	$0.426 + j0.048$	$1.99 + j0.392$
440	$0.407 + j0.044$	$1.99 + j0.537$
445	$0.429 + j0.262$	$2.05 + j0.675$
450	$0.452 + j0.341$	$2.10 + j0.765$

Z_{source} = Test circuit impedance as measured from gate to ground.

Z_{load} = Test circuit impedance as measured from drain to ground.

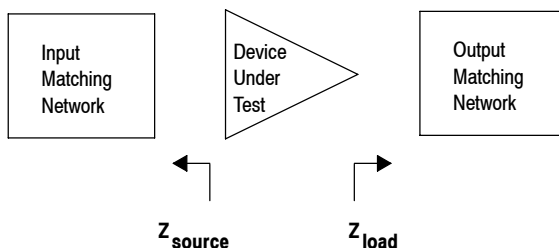
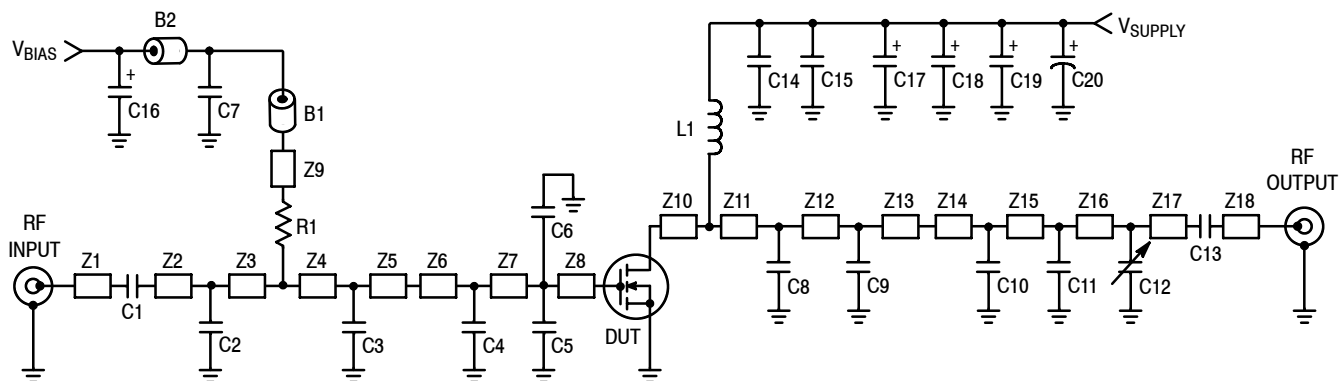

Figure 18. Series Equivalent Source and Load Impedance — 420-430 MHz



Z1	0.402" x 0.080" Microstrip	Z11	0.125" x 0.220" Microstrip
Z2	1.266" x 0.080" Microstrip	Z12	0.324" x 0.220" Microstrip
Z3	0.211" x 0.220" Microstrip	Z13	0.050" x 0.220" Microstrip
Z4	0.139" x 0.220" Microstrip	Z14	0.171" x 0.080" Microstrip
Z5	0.239" x 0.220" Microstrip	Z15	0.377" x 0.080" Microstrip
Z6	0.040" x 0.640" Microstrip	Z16	0.358" x 0.080" Microstrip
Z7	0.080" x 0.640" Microstrip	Z17	0.361" x 0.080" Microstrip
Z8	0.276" x 0.640" Microstrip	Z18	0.408" x 0.080" Microstrip
Z9	1.000" x 0.226" Microstrip	PCB	Arlon GX-0300-55-22, 0.030", $\epsilon_r = 2.55$
Z10	0.498" x 0.630" Microstrip		

Figure 19. MRF5S4140HR3(SR3) Test Circuit Schematic — 489-499 MHz

Table 7. MRF5S4140HR3(SR3) Test Circuit Component Designations and Values — 489-499 MHz

Part	Description	Part Number	Manufacturer
B1, B2	Ferrite Beads, Short	2743019447	Fair-Rite
C1, C13	120 pF Chip Capacitors	100B121JP500X	ATC
C2	18 pF Chip Capacitor	100B180JP500X	ATC
C3, C4	24 pF Chip Capacitors	100B240JP500X	ATC
C5, C6	13 pF Chip Capacitors	100B130JP500X	ATC
C7	0.02 μ F, 50 V Chip Capacitor	200B203MW50B	ATC
C8, C9	22 pF Chip Capacitors	100B220JP500X	ATC
C10	1.0 pF Chip Capacitor	100B1R0JP500X	ATC
C11	5.6 pF Chip Capacitor	100B5R6JP500X	ATC
C12	0.8-8.0 pF Variable Capacitor, Gigatrim	27291SL	Johanson
C14	47 pF Chip Capacitor	100B47JP500X	ATC
C15	0.56 μ F, 50 V Chip Capacitor	C1825C564J5GAC	Kemet
C16, C17, C18, C19	10 μ F, 35 V Tantalum Capacitors	T491D106K035AS	Kemet
C20	470 μ F, 63 V Electrolytic Capacitor	SME63V471M12X25LL	United Chemi-Con
L1	39 nH Inductor	1812SMS-39N	Coilcraft
R1	100 Ω , 1/4 W Chip Resistor (1210)		

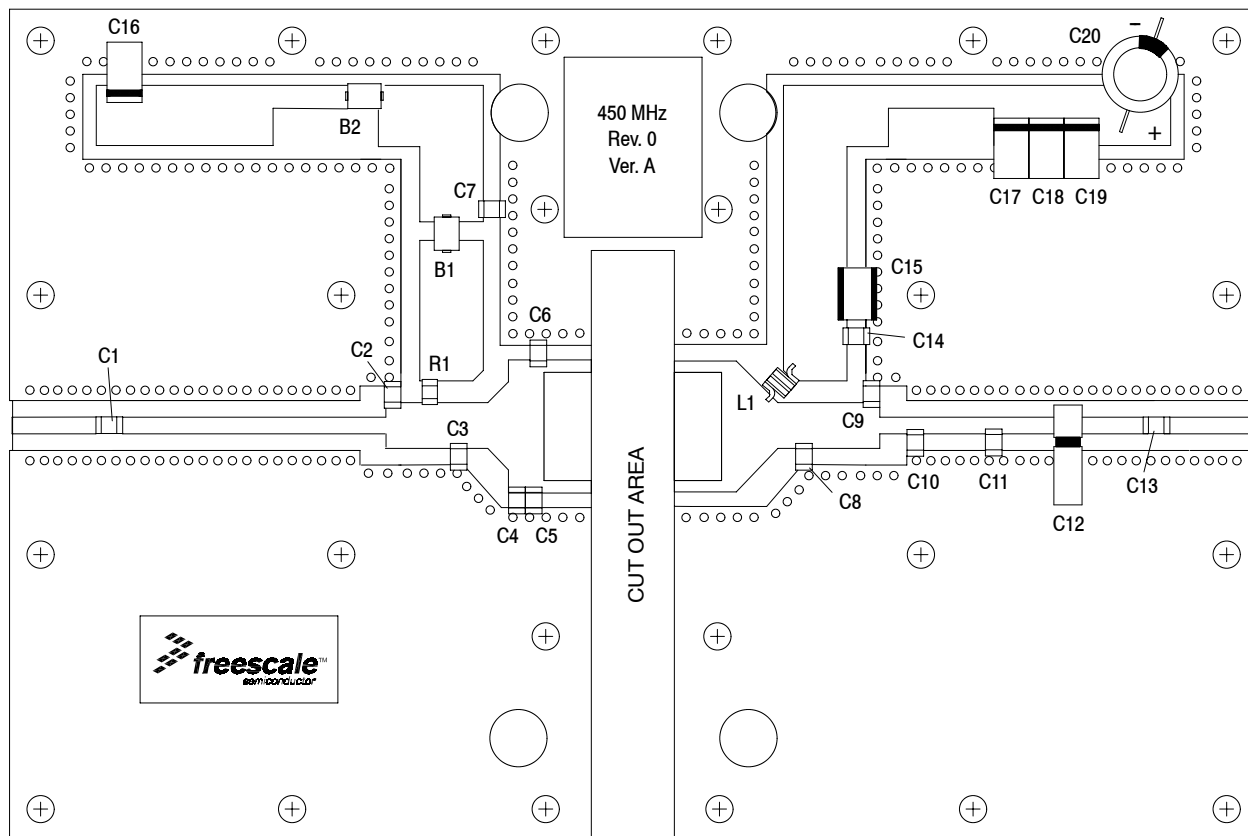

Figure 20. MRF5S4140HR3(SR3) Test Circuit Component Layout — 489-499 MHz

ARCHIVE INFORMATION

ARCHIVE INFORMATION

TYPICAL CHARACTERISTICS — 489-499 MHz

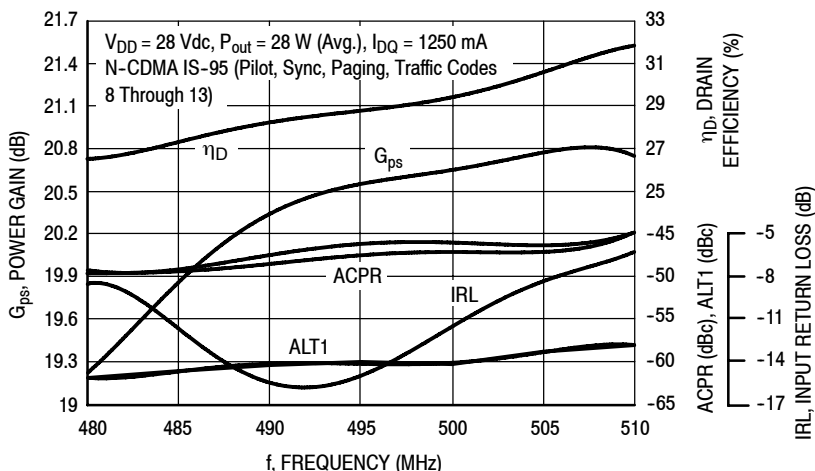

Figure 21. Single-Carrier N-CDMA Broadband Performance @ $P_{out} = 28$ Watts Avg.

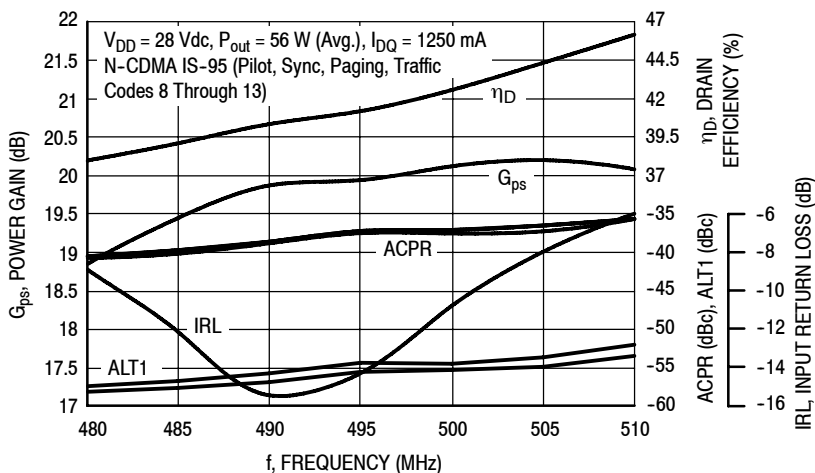
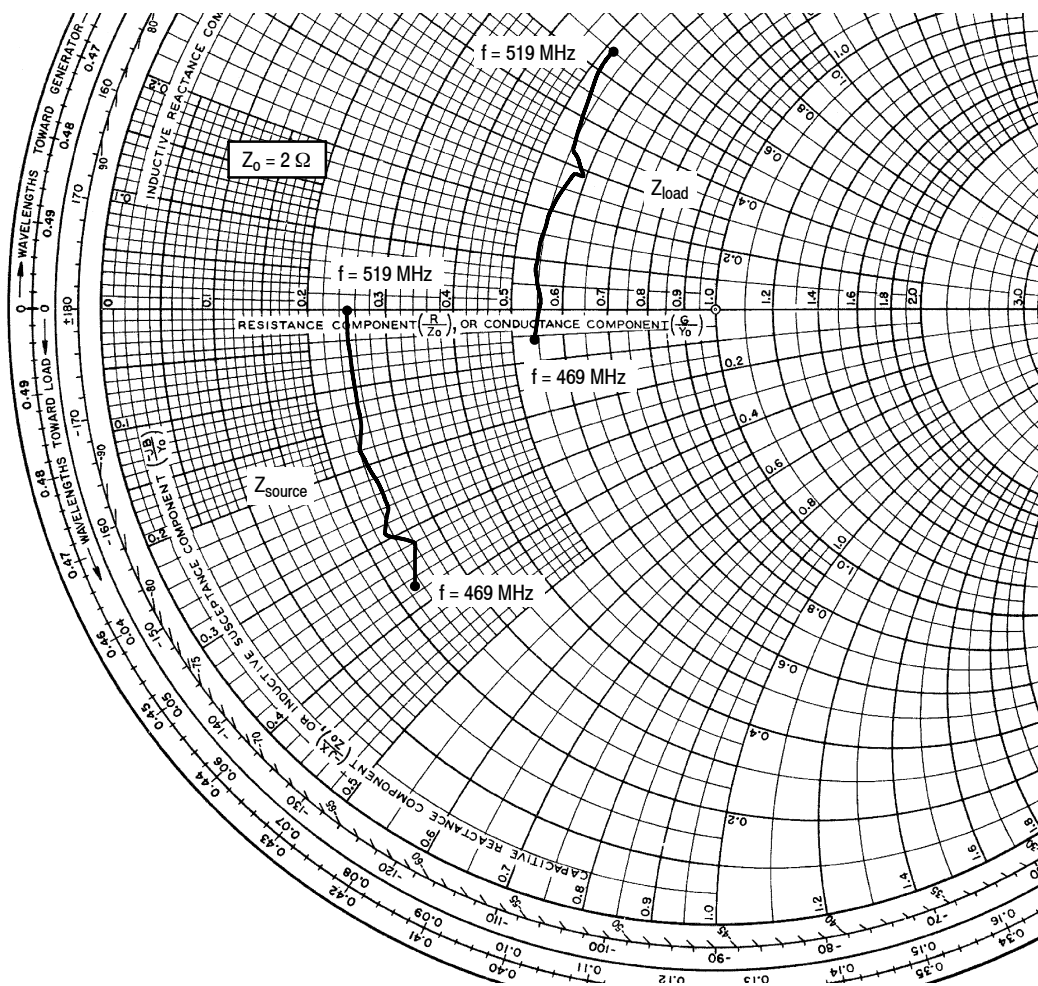

Figure 22. Single-Carrier N-CDMA Broadband Performance @ $P_{out} = 56$ Watts Avg.

ARCHIVE INFORMATION

ARCHIVE INFORMATION



$V_{DD} = 28 \text{ Vdc}$, $I_{DQ} = 1250 \text{ mA}$, $P_{out} = 28 \text{ W Avg.}$

f MHz	Z_{source} Ω	Z_{load} Ω
469	$0.454 - j0.742$	$1.08 - j0.129$
474	$0.510 - j0.637$	$1.12 + j0.043$
479	$0.467 - j0.581$	$1.07 + j0.160$
484	$0.495 - j0.513$	$1.09 + j0.294$
489	$0.495 - j0.457$	$1.12 + j0.430$
494	$0.478 - j0.360$	$1.16 + j0.573$
499	$0.505 - j0.295$	$1.18 + j0.586$
504	$0.502 - j0.249$	$1.11 + j0.653$
509	$0.502 - j0.048$	$1.07 + j0.810$
514	$0.499 + j0.002$	$1.03 + j1.01$
519	$0.502 + j0.003$	$1.03 + j1.10$

Z_{source} = Test circuit impedance as measured from gate to ground.

Z_{load} = Test circuit impedance as measured from drain to ground.

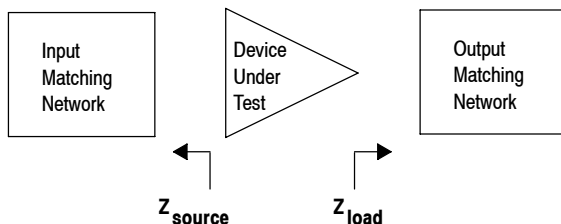
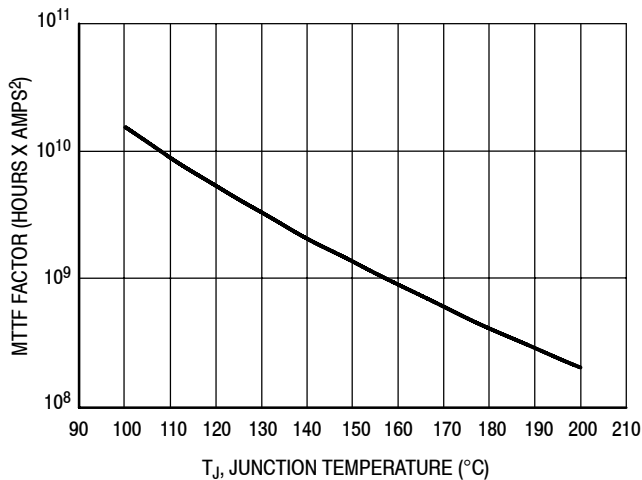

Figure 23. Series Equivalent Source and Load Impedance — 489-499 MHz

TYPICAL CHARACTERISTICS



This above graph displays calculated MTTF in hours x ampere² drain current. Life tests at elevated temperatures have correlated to better than ±10% of the theoretical prediction for metal failure. Divide MTTF factor by I_D^2 for MTTF in a particular application.

Figure 24. MTTF Factor versus Junction Temperature

N-CDMA TEST SIGNAL

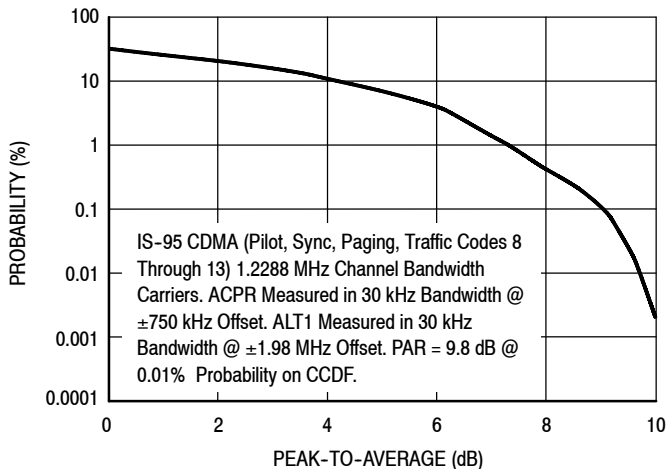

Figure 25. Single-Carrier CCDF N-CDMA

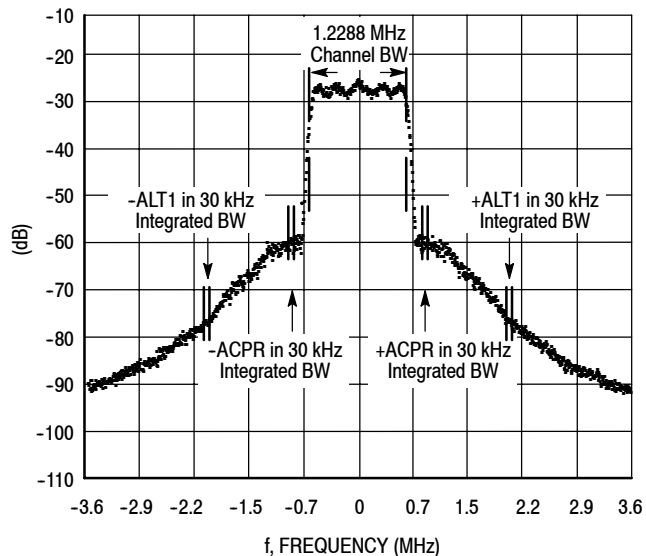
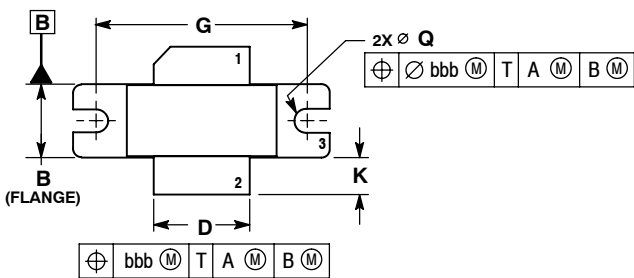

Figure 26. Single-Carrier N-CDMA Spectrum

ARCHIVE INFORMATION

ARCHIVE INFORMATION

PACKAGE DIMENSIONS



- NOTES:
1. DIMENSIONING AND TOLERANCING PER ANSI Y14.5M-1994.
 2. CONTROLLING DIMENSION: INCH.
 3. DELETED
 4. DIMENSION H IS MEASURED 0.030 (0.762) AWAY FROM PACKAGE BODY.

DIM	INCHES		MILLIMETERS	
	MIN	MAX	MIN	MAX
A	1.335	1.345	33.91	34.16
B	0.380	0.390	9.65	9.91
C	0.125	0.170	3.18	4.32
D	0.495	0.505	12.57	12.83
E	0.035	0.045	0.89	1.14
F	0.003	0.006	0.08	0.15
G	1.100	BSC	27.94	BSC
H	0.057	0.067	1.45	1.70
K	0.170	0.210	4.32	5.33
M	0.774	0.786	19.66	19.96
N	0.772	0.788	19.60	20.00
Q	∅ 0.118	∅ 0.138	∅ 3.00	∅ 3.51
R	0.365	0.375	9.27	9.53
S	0.365	0.375	9.27	9.52
aaa	0.005	REF	0.127	REF
bbb	0.010	REF	0.254	REF
ccc	0.015	REF	0.381	REF

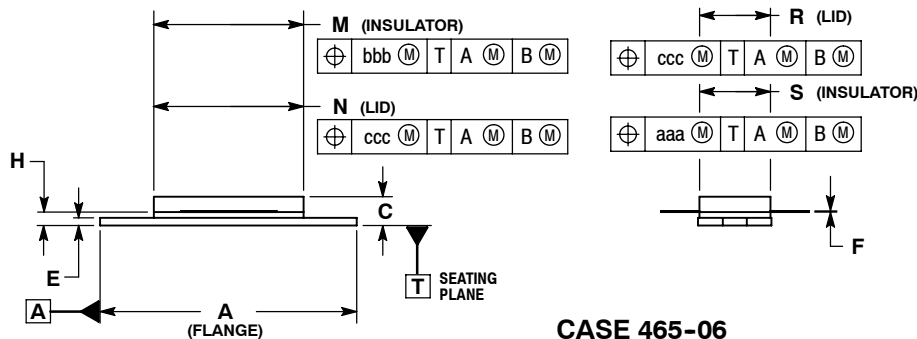

**CASE 465-06
ISSUE G
NI-780
MRF5S4140HR3**

- STYLE 1:
PIN 1. DRAIN
2. GATE
3. SOURCE

ARCHIVE INFORMATION

ARCHIVE INFORMATION

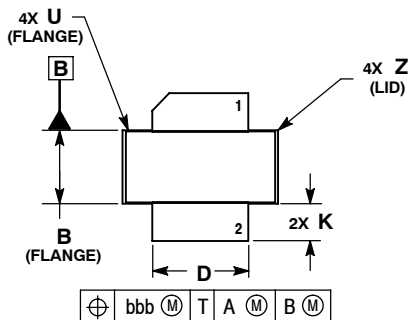

- NOTES:
1. DIMENSIONING AND TOLERANCING PER ANSI Y14.5M-1994.
 2. CONTROLLING DIMENSION: INCH.
 3. DELETED
 4. DIMENSION H IS MEASURED 0.030 (0.762) AWAY FROM PACKAGE BODY.

DIM	INCHES		MILLIMETERS	
	MIN	MAX	MIN	MAX
A	0.805	0.815	20.45	20.70
B	0.380	0.390	9.65	9.91
C	0.125	0.170	3.18	4.32
D	0.495	0.505	12.57	12.83
E	0.035	0.045	0.89	1.14
F	0.003	0.006	0.08	0.15
H	0.057	0.067	1.45	1.70
K	0.170	0.210	4.32	5.33
M	0.774	0.786	19.61	20.02
N	0.772	0.788	19.61	20.02
R	0.365	0.375	9.27	9.53
S	0.365	0.375	9.27	9.52
U	---	0.040	---	1.02
Z	---	0.030	---	0.76
aaa	0.005	REF	0.127	REF
bbb	0.010	REF	0.254	REF
ccc	0.015	REF	0.381	REF

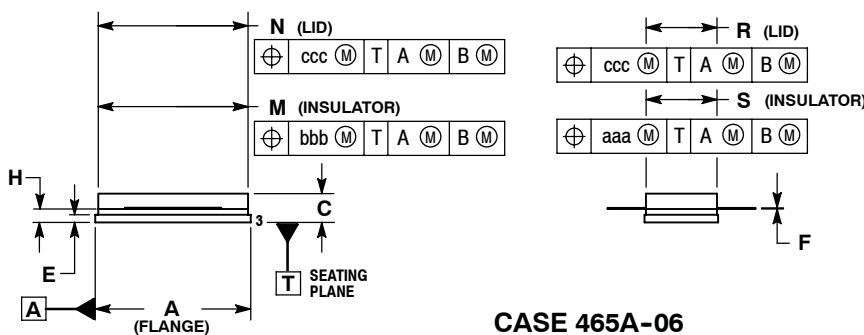

**CASE 465A-06
ISSUE H
NI-780S
MRF5S4140HSR3**

- STYLE 1:
PIN 1. DRAIN
2. GATE
5. SOURCE

How to Reach Us:

Home Page:
www.freescale.com

E-mail:
support@freescale.com

USA/Europe or Locations Not Listed:
Freescale Semiconductor
Technical Information Center, CH370
1300 N. Alma School Road
Chandler, Arizona 85224
+1-800-521-6274 or +1-480-768-2130
support@freescale.com

Europe, Middle East, and Africa:
Freescale Halbleiter Deutschland GmbH
Technical Information Center
Schatzbogen 7
81829 Muenchen, Germany
+44 1296 380 456 (English)
+46 8 52200080 (English)
+49 89 92103 559 (German)
+33 1 69 35 48 48 (French)
support@freescale.com

Japan:
Freescale Semiconductor Japan Ltd.
Headquarters
ARCO Tower 15F
1-8-1, Shimo-Meguro, Meguro-ku,
Tokyo 153-0064
Japan
0120 191014 or +81 3 5437 9125
support.japan@freescale.com

Asia/Pacific:
Freescale Semiconductor Hong Kong Ltd.
Technical Information Center
2 Dai King Street
Tai Po Industrial Estate
Tai Po, N.T., Hong Kong
+800 2666 8080
support.asia@freescale.com

For Literature Requests Only:
Freescale Semiconductor Literature Distribution Center
P.O. Box 5405
Denver, Colorado 80217
1-800-441-2447 or 303-675-2140
Fax: 303-675-2150
LDCForFreescaleSemiconductor@hibbertgroup.com

Information in this document is provided solely to enable system and software implementers to use Freescale Semiconductor products. There are no express or implied copyright licenses granted hereunder to design or fabricate any integrated circuits or integrated circuits based on the information in this document.

Freescale Semiconductor reserves the right to make changes without further notice to any products herein. Freescale Semiconductor makes no warranty, representation or guarantee regarding the suitability of its products for any particular purpose, nor does Freescale Semiconductor assume any liability arising out of the application or use of any product or circuit, and specifically disclaims any and all liability, including without limitation consequential or incidental damages. "Typical" parameters that may be provided in Freescale Semiconductor data sheets and/or specifications can and do vary in different applications and actual performance may vary over time. All operating parameters, including "Typicals", must be validated for each customer application by customer's technical experts. Freescale Semiconductor does not convey any license under its patent rights nor the rights of others. Freescale Semiconductor products are not designed, intended, or authorized for use as components in systems intended for surgical implant into the body, or other applications intended to support or sustain life, or for any other application in which the failure of the Freescale Semiconductor product could create a situation where personal injury or death may occur. Should Buyer purchase or use Freescale Semiconductor products for any such unintended or unauthorized application, Buyer shall indemnify and hold Freescale Semiconductor and its officers, employees, subsidiaries, affiliates, and distributors harmless against all claims, costs, damages, and expenses, and reasonable attorney fees arising out of, directly or indirectly, any claim of personal injury or death associated with such unintended or unauthorized use, even if such claim alleges that Freescale Semiconductor was negligent regarding the design or manufacture of the part.

Freescale™ and the Freescale logo are trademarks of Freescale Semiconductor, Inc. All other product or service names are the property of their respective owners.
© Freescale Semiconductor, Inc. 2006, 2010. All rights reserved.

Looking for pricing, stock, or lifecycle information?

Click below to explore more details on WIN SOURCE:

 [View MRF5S4140HR3 on WIN SOURCE](#)

 [NXP / Nexperia Information](#)

Optimize Your Supply Chain with WIN SOURCE Solutions

-  Global Sourcing Solution
-  Obsolete Management
-  Cost Control Management
-  Shortage Management
-  Alternative Solution
-  Excess Inventory Management