



**THE DATASHEET OF
MRF5S4140HSR3**



RF Power Field Effect Transistors

N-Channel Enhancement-Mode Lateral MOSFETs

Designed for broadband commercial and industrial applications with frequencies from 400 to 500 MHz. The high gain and broadband performance of these devices make them ideal for large-signal, common-source amplifier applications in 28-volt base station equipment.

- Typical Single-Carrier N-CDMA Performance @ 465 MHz: $V_{DD} = 28$ Volts, $I_{DQ} = 1250$ mA, $P_{out} = 28$ Watts Avg., IS-95 CDMA (Pilot, Sync, Paging, Traffic Codes 8 Through 13). Channel Bandwidth = 1.2288 MHz. PAR = 9.8 dB @ 0.01% Probability on CCDF.
Power Gain — 21 dB
Drain Efficiency — 30%
ACPR @ 750 kHz Offset — -47.6 dBc in 30 kHz Bandwidth
- Capable of Handling 10:1 VSWR, @ 28 Vdc, 465 MHz, 140 Watts CW Output Power

Features

- Characterized with Series Equivalent Large-Signal Impedance Parameters
- Internally Matched for Ease of Use
- Qualified Up to a Maximum of 32 V_{DD} Operation
- Integrated ESD Protection
- Lower Thermal Resistance Package
- Low Gold Plating Thickness on Leads, 40 μ " Nominal.
- RoHS Compliant
- In Tape and Reel. R3 Suffix = 250 Units per 56 mm, 13 inch Reel.

MRF5S4140HR3
MRF5S4140HSR3

465 MHz, 28 W AVG., 28 V
SINGLE N-CDMA
LATERAL N-CHANNEL
RF POWER MOSFETs

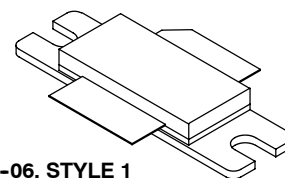

CASE 465-06, STYLE 1
NI-780
MRF5S4140HR3

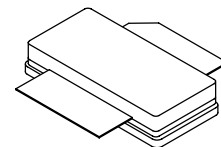

CASE 465A-06, STYLE 1
NI-780S
MRF5S4140HSR3

ARCHIVE INFORMATION

ARCHIVE INFORMATION

Table 1. Maximum Ratings

| Rating | Symbol | Value | Unit |
|---|-----------|--------------|--------------------------|
| Drain-Source Voltage | V_{DSS} | -0.5, +65 | Vdc |
| Gate-Source Voltage | V_{GS} | -0.5, +15 | Vdc |
| Total Device Dissipation @ $T_C = 25^\circ\text{C}$ Derate above 25 $^\circ\text{C}$ | P_D | 427 2.4 | W W/ $^\circ\text{C}$ |
| Storage Temperature Range | T_{stg} | - 65 to +150 | $^\circ\text{C}$ |
| Case Operating Temperature | T_C | 150 | $^\circ\text{C}$ |
| Operating Junction Temperature | T_J | 200 | $^\circ\text{C}$ |

Table 2. Thermal Characteristics

| Characteristic | Symbol | Value (1,2) | Unit |
|---|-----------------|--------------|---------------------------|
| Thermal Resistance, Junction to Case Case Temperature 73 $^\circ\text{C}$, 140 W CW Case Temperature 74 $^\circ\text{C}$, 28 W CW | $R_{\theta JC}$ | 0.41 0.47 | $^\circ\text{C}/\text{W}$ |

1. MTTF calculator available at <http://www.freescale.com/rf>. Select Tools/Software/Application Software/Calculators to access the MTTF calculators by product.
2. Refer to AN1955, *Thermal Measurement Methodology of RF Power Amplifiers*. Go to <http://www.freescale.com/rf>. Select Documentation/Application Notes - AN1955.

Table 3. ESD Protection Characteristics

| Test Methodology | Class |
|---------------------------------------|--------------|
| Human Body Model (per JESD22-A114) | 2 (Minimum) |
| Machine Model (per EIA/JESD22-A115) | A (Minimum) |
| Charge Device Model (per JESD22-C101) | IV (Minimum) |

Table 4. Electrical Characteristics ($T_C = 25^\circ\text{C}$ unless otherwise noted)

| Characteristic | Symbol | Min | Typ | Max | Unit |
|----------------|--------|-----|-----|-----|------|
|----------------|--------|-----|-----|-----|------|

Off Characteristics

| | | | | | |
|---|-----------|---|---|----|-----------------|
| Zero Gate Voltage Drain Leakage Current ($V_{DS} = 65\text{ Vdc}$, $V_{GS} = 0\text{ Vdc}$) | I_{DSS} | — | — | 10 | μAdc |
| Zero Gate Voltage Drain Leakage Current ($V_{DS} = 28\text{ Vdc}$, $V_{GS} = 0\text{ Vdc}$) | I_{DSS} | — | — | 1 | μAdc |
| Gate-Source Leakage Current ($V_{GS} = 5\text{ Vdc}$, $V_{DS} = 0\text{ Vdc}$) | I_{GSS} | — | — | 1 | μAdc |

On Characteristics

| | | | | | |
|--|--------------|-----|-----|-----|-----|
| Gate Threshold Voltage ($V_{DS} = 10\text{ Vdc}$, $I_D = 400\ \mu\text{Adc}$) | $V_{GS(th)}$ | 2 | 3 | 4 | Vdc |
| Gate Quiescent Voltage ($V_{DS} = 28\text{ Vdc}$, $I_D = 1250\text{ mAdc}$, Measured in Functional Test) | $V_{GS(Q)}$ | 3 | 4 | 5 | Vdc |
| Drain-Source On-Voltage ($V_{GS} = 10\text{ Vdc}$, $I_D = 2.42\text{ Adc}$) | $V_{DS(on)}$ | 0.1 | 0.2 | 0.3 | Vdc |
| Forward Transconductance ($V_{DS} = 10\text{ Vdc}$, $I_D = 3\text{ Adc}$) | g_{fs} | — | 6.2 | — | S |

Dynamic Characteristics (1)

| | | | | | |
|---|-----------|---|-----|---|----|
| Reverse Transfer Capacitance ($V_{DS} = 28\text{ Vdc} \pm 30\text{ mV(rms)ac}$ @ 1 MHz, $V_{GS} = 0\text{ Vdc}$) | C_{rss} | — | 2.3 | — | pF |
|---|-----------|---|-----|---|----|

Functional Tests (In Freescale Test Fixture, 50 ohm system) $V_{DD} = 28\text{ Vdc}$, $I_{DQ} = 1250\text{ mA}$, $P_{out} = 28\text{ W Avg. N-CDMA}$, $f = 465\text{ MHz}$, Single-Carrier N-CDMA, 1.2288 MHz Channel Bandwidth Carrier. ACPR measured in 30 kHz Channel Bandwidth @ $\pm 750\text{ kHz}$ Offset. PAR = 9.8 dB @ 0.01% Probability on CCDF.

| | | | | | |
|------------------------------|----------|------|-------|-----|-----|
| Power Gain | G_{ps} | 20 | 21 | 23 | dB |
| Drain Efficiency | η_D | 28.5 | 30 | — | % |
| Adjacent Channel Power Ratio | ACPR | — | -47.6 | -45 | dBc |
| Input Return Loss | IRL | — | -14 | -9 | dB |

1. Part internally input matched.

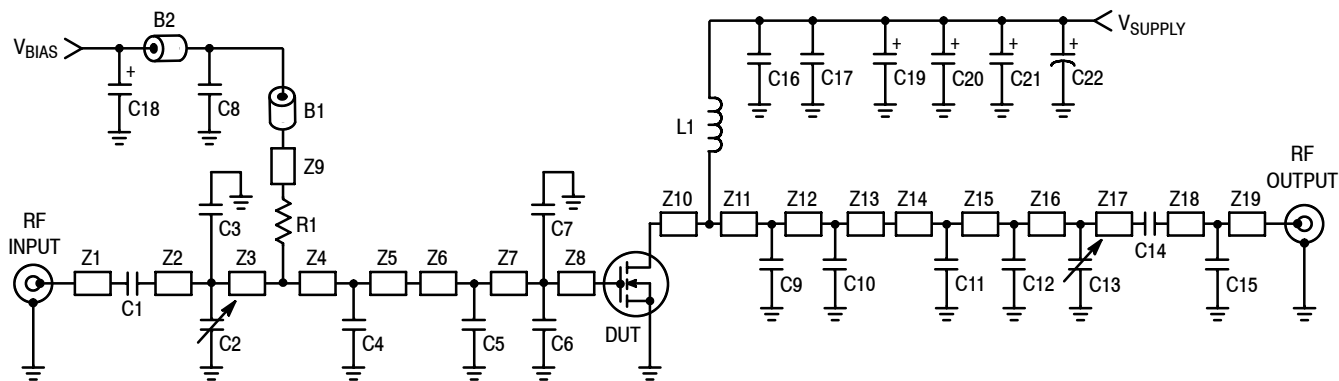

| | | | |
|-----|----------------------------|-----|--|
| Z1 | 0.402" x 0.080" Microstrip | Z11 | 0.125" x 0.220" Microstrip |
| Z2 | 1.266" x 0.080" Microstrip | Z12 | 0.324" x 0.220" Microstrip |
| Z3 | 0.211" x 0.220" Microstrip | Z13 | 0.050" x 0.220" Microstrip |
| Z4 | 0.139" x 0.220" Microstrip | Z14 | 0.171" x 0.080" Microstrip |
| Z5 | 0.239" x 0.220" Microstrip | Z15 | 0.377" x 0.080" Microstrip |
| Z6 | 0.040" x 0.640" Microstrip | Z16 | 0.358" x 0.080" Microstrip |
| Z7 | 0.080" x 0.640" Microstrip | Z17 | 0.361" x 0.080" Microstrip |
| Z8 | 0.276" x 0.640" Microstrip | Z18 | 0.131" x 0.080" Microstrip |
| Z9 | 1.000" x 0.226" Microstrip | Z19 | 0.277" x 0.080" Microstrip |
| Z10 | 0.498" x 0.630" Microstrip | PCB | Arlon GX-0300-55-22, 0.030", $\epsilon_r = 2.55$ |

Figure 1. MRF5S4140HR3(SR3) Test Circuit Schematic — 460-470 MHz

Table 5. MRF5S4140HR3(SR3) Test Circuit Component Designations and Values — 460-470 MHz

| Part | Description | Part Number | Manufacturer |
|--------------------|---|-------------------|------------------|
| B1, B2 | Ferrite Beads, Short | 2743019447 | Fair-Rite |
| C1, C14 | 120 pF Chip Capacitors | 100B121JP500X | ATC |
| C2, C13 | 0.8-8.0 pF Variable Capacitors, Gigatrim | 27291SL | Johanson |
| C3 | 18 pF Chip Capacitor | 100B180JP500X | ATC |
| C4 | 30 pF Chip Capacitor | 100B300JP500X | ATC |
| C5 | 24 pF Chip Capacitor | 100B240JP500X | ATC |
| C6, C7 | 13 pF Chip Capacitors | 100B130JP500X | ATC |
| C8 | 0.02 μ F, 50 V Chip Capacitor | 200B203MW50B | ATC |
| C9, C10 | 22 pF Chip Capacitors | 100B220JP500X | ATC |
| C11 | 1.0 pF Chip Capacitor | 100B1R0JP500X | ATC |
| C12 | 5.6 pF Chip Capacitor | 100B5R6JP500X | ATC |
| C15 | 1.5 pF Chip Capacitor | 100B1R5JP500X | ATC |
| C16 | 47 pF Chip Capacitor | 100B47JP500X | ATC |
| C17 | 0.56 μ F, 50 V Chip Capacitor | C1825C564J5GAC | Kemet |
| C18, C19, C20, C21 | 10 μ F, 35 V Tantalum Chip Capacitors | T491D106K035AS | Kemet |
| C22 | 470 μ F, 63 V Electrolytic Capacitor | SME63V471M12X25LL | United Chemi-Con |
| L1 | 39 nH Inductor | 1812SMS-39N | Coilcraft |
| R1 | 100 Ω , 1/4 W Chip Resistor (1210) | | |

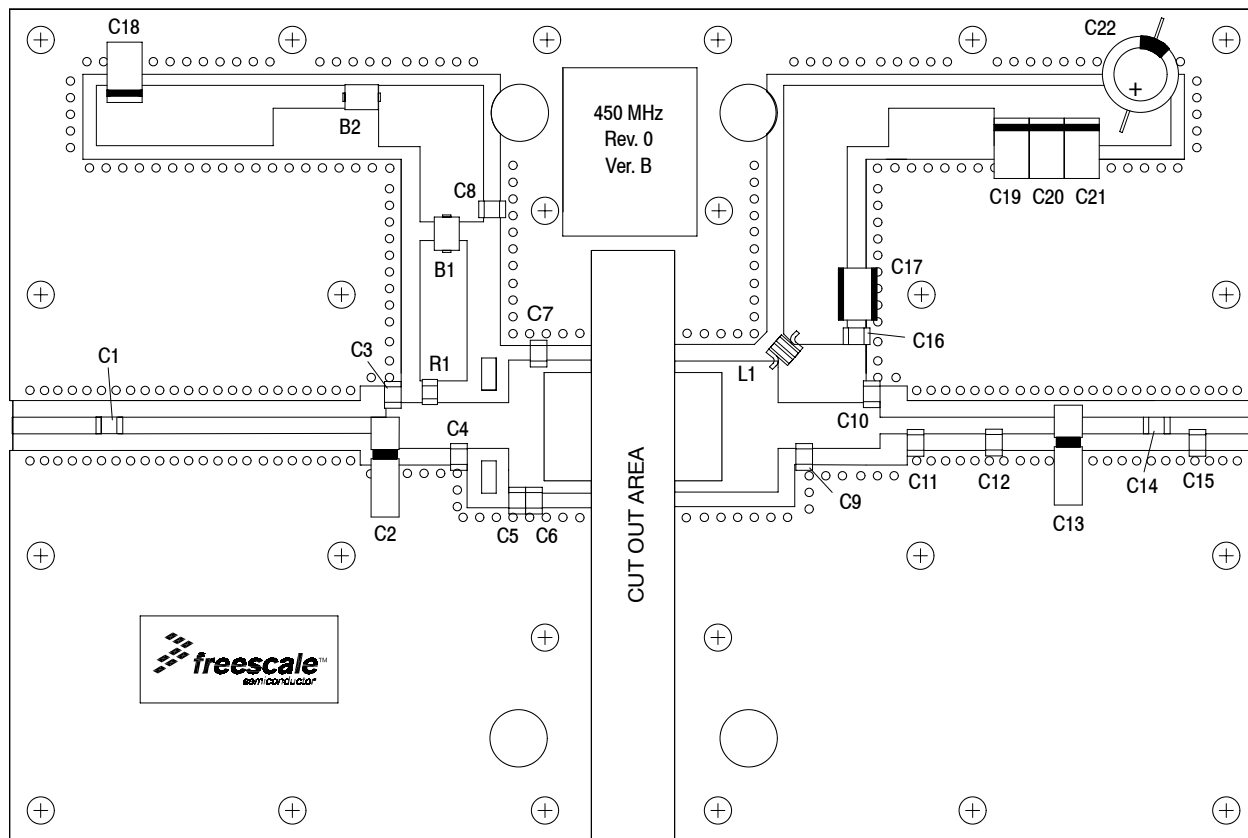

Figure 2. MRF5S4140HR3(SR3) Test Circuit Component Layout — 460-470 MHz

ARCHIVE INFORMATION

ARCHIVE INFORMATION

TYPICAL CHARACTERISTICS — 460-470 MHz

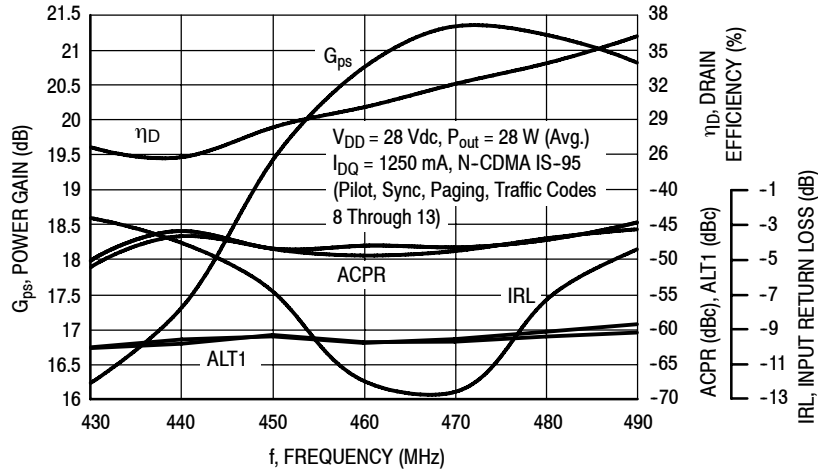

Figure 3. Single-Carrier N-CDMA Broadband Performance @ $P_{out} = 28$ Watts Avg.

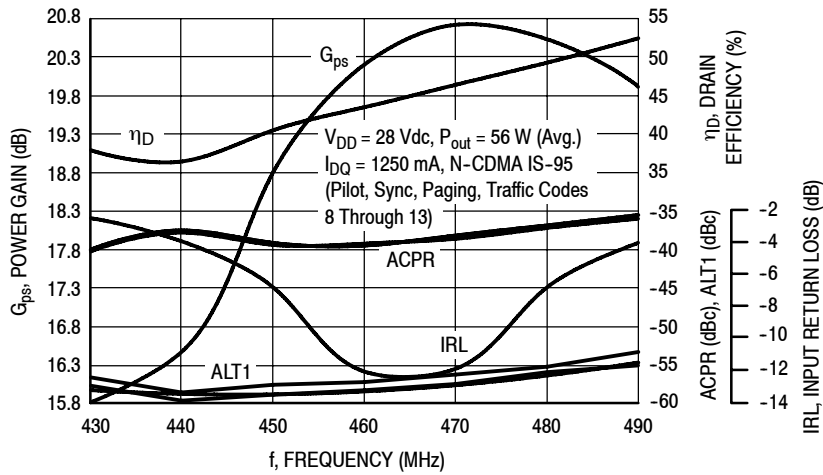

Figure 4. Single-Carrier N-CDMA Broadband Performance @ $P_{out} = 56$ Watts Avg.

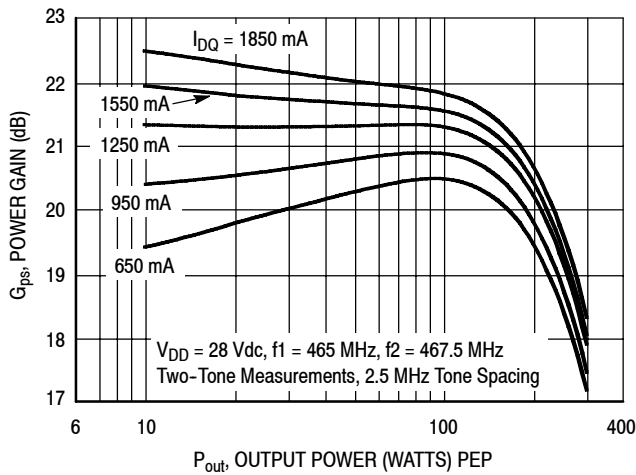

Figure 5. Two-Tone Power Gain versus Output Power

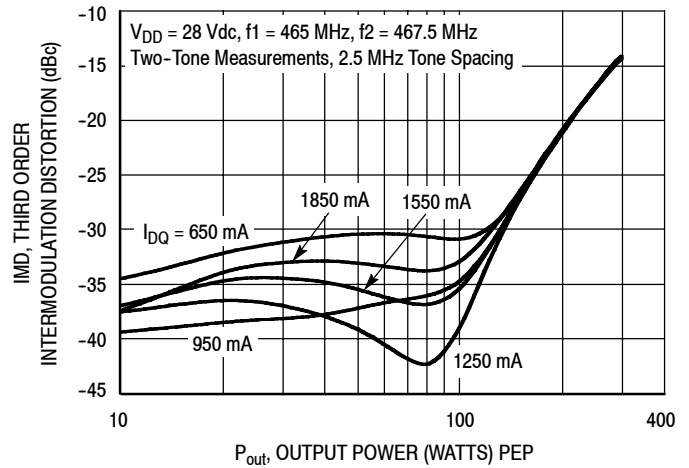

Figure 6. Third Order Intermodulation Distortion versus Output Power

ARCHIVE INFORMATION

ARCHIVE INFORMATION

TYPICAL CHARACTERISTICS — 460-470 MHz

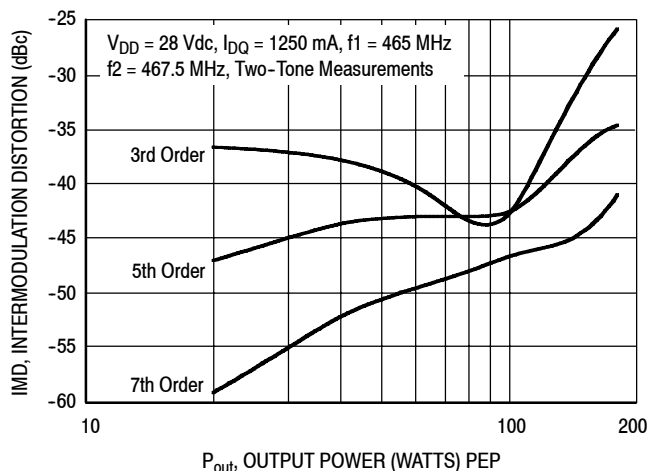

Figure 7. Intermodulation Distortion Products versus Output Power

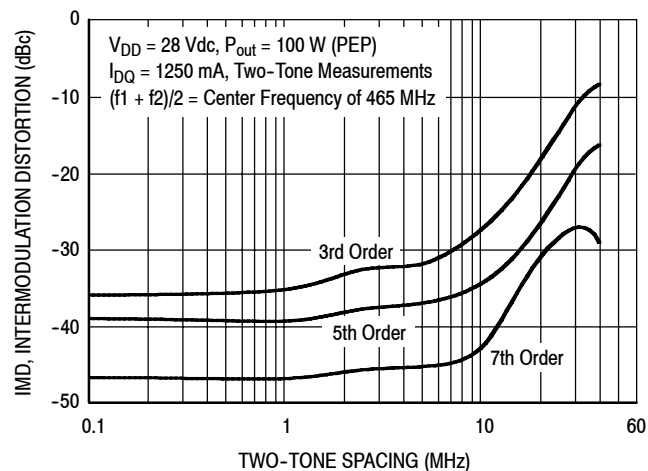

Figure 8. Intermodulation Distortion Products versus Tone Spacing

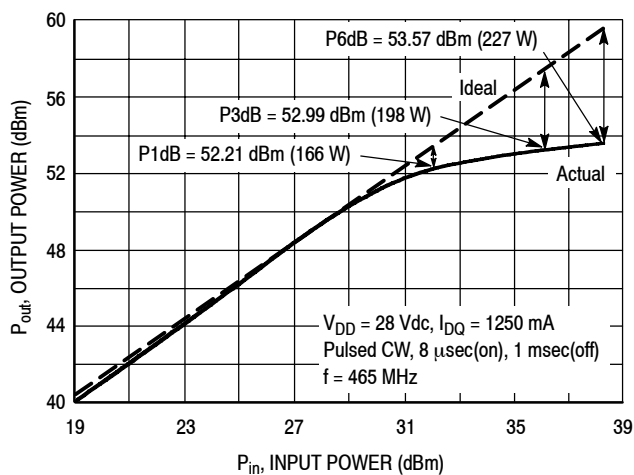

Figure 9. Pulse CW Output Power versus Input Power

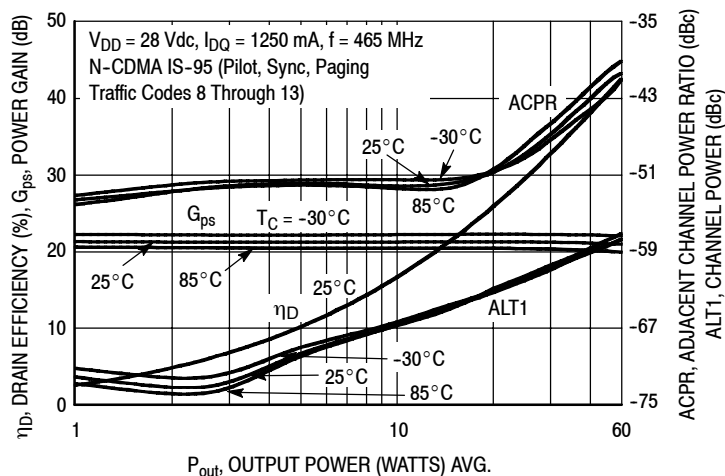

Figure 10. Single-Carrier N-CDMA ACPR, ALT1, Power Gain and Drain Efficiency versus Output Power

ARCHIVE INFORMATION

ARCHIVE INFORMATION

TYPICAL CHARACTERISTICS — 460-470 MHz

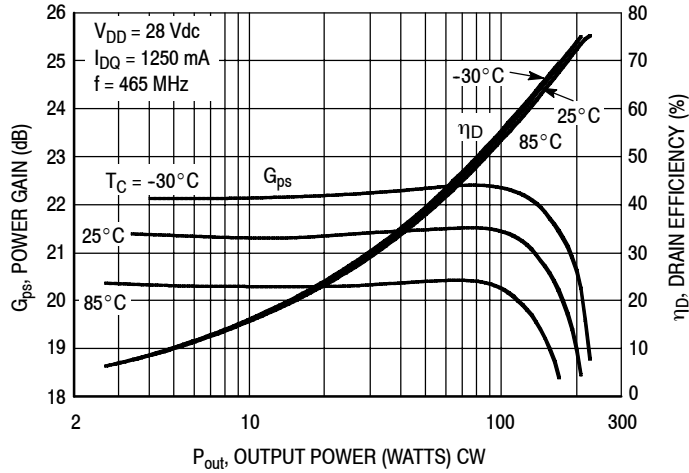

Figure 11. Power Gain and Drain Efficiency versus CW Output Power

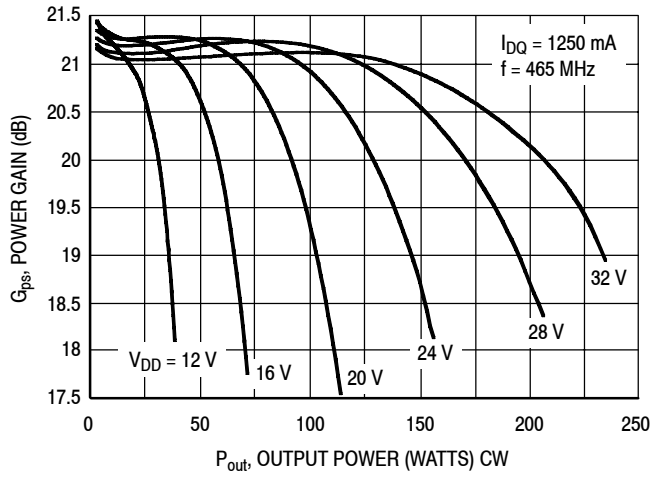
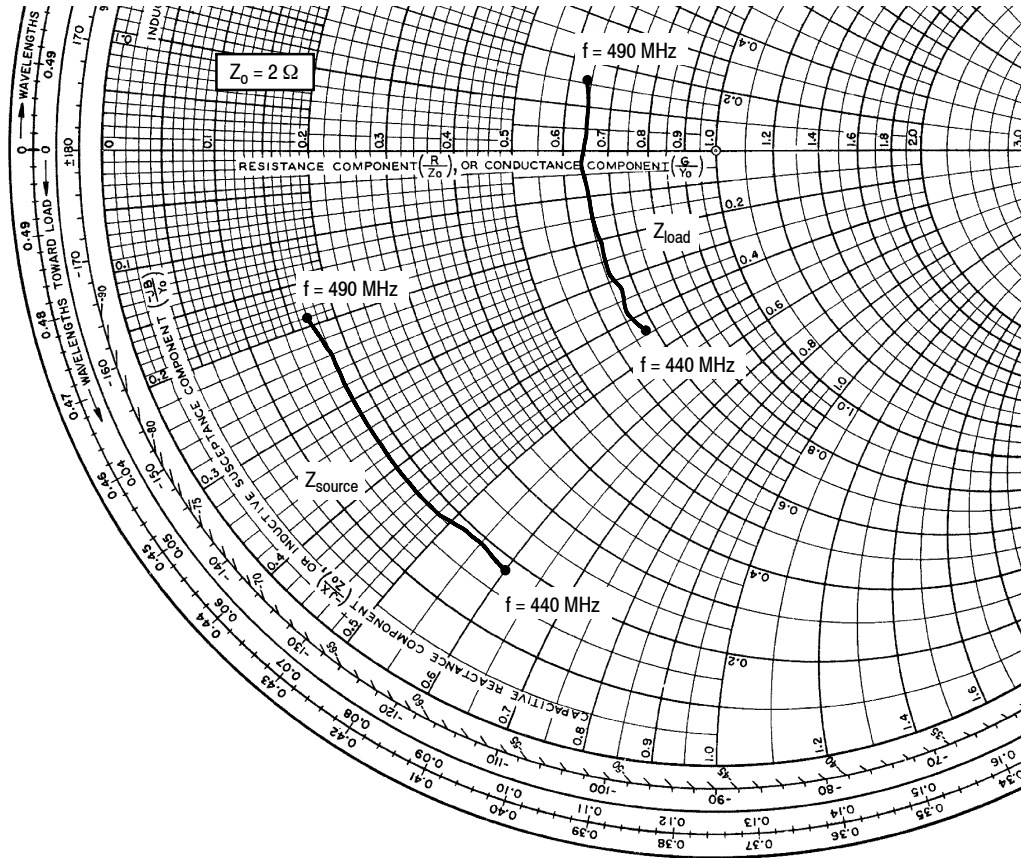

Figure 12. Power Gain versus Output Power

ARCHIVE INFORMATION

ARCHIVE INFORMATION



$V_{DD} = 28 \text{ Vdc}$, $I_{DQ} = 1250 \text{ mA}$, $P_{out} = 28 \text{ W Avg.}$

| f MHz | Z_{source} Ω | Z_{load} Ω |
|----------|--------------------------|------------------------|
| 440 | $0.359 - j1.19$ | $1.35 - j0.870$ |
| 445 | $0.389 - j1.11$ | $1.31 - j0.743$ |
| 450 | $0.379 - j1.03$ | $1.34 - j0.641$ |
| 455 | $0.360 - j0.959$ | $1.32 - j0.539$ |
| 460 | $0.355 - j0.873$ | $1.31 - j0.420$ |
| 465 | $0.352 - j0.773$ | $1.30 - j0.274$ |
| 470 | $0.350 - j0.710$ | $1.29 - j0.173$ |
| 475 | $0.350 - j0.628$ | $1.28 - j0.044$ |
| 480 | $0.356 - j0.540$ | $1.29 + j0.090$ |
| 485 | $0.355 - j0.473$ | $1.29 + j0.195$ |
| 490 | $0.345 - j0.388$ | $1.28 + j0.313$ |

Z_{source} = Test circuit impedance as measured from gate to ground.

Z_{load} = Test circuit impedance as measured from drain to ground.

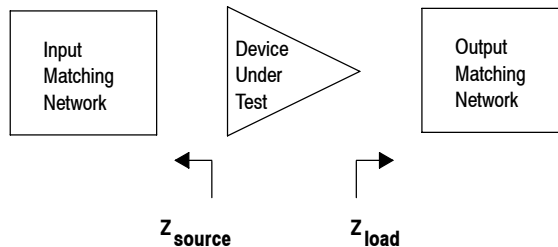
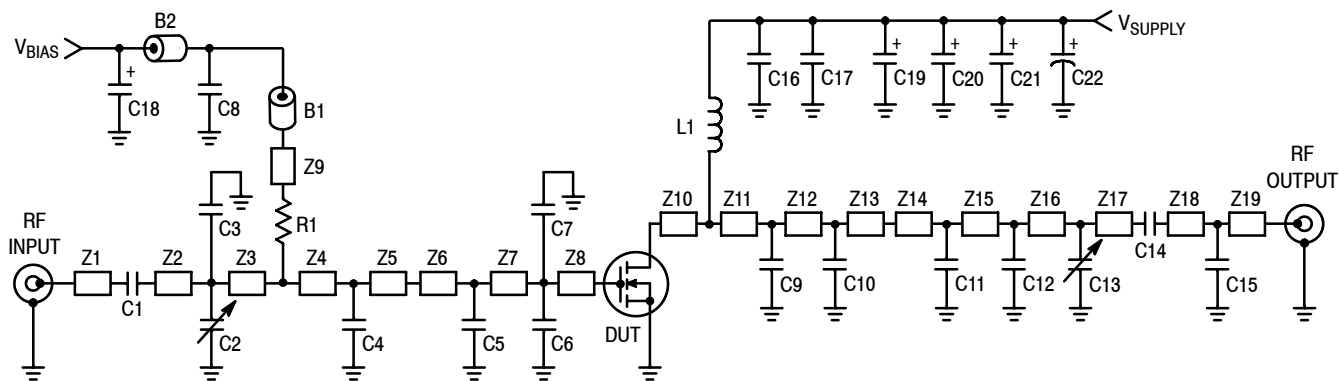

Figure 13. Series Equivalent Source and Load Impedance — 460-470 MHz



| | | | |
|-----|----------------------------|-----|--|
| Z1 | 0.402" x 0.080" Microstrip | Z11 | 0.125" x 0.220" Microstrip |
| Z2 | 1.266" x 0.080" Microstrip | Z12 | 0.324" x 0.220" Microstrip |
| Z3 | 0.211" x 0.220" Microstrip | Z13 | 0.050" x 0.220" Microstrip |
| Z4 | 0.139" x 0.220" Microstrip | Z14 | 0.171" x 0.080" Microstrip |
| Z5 | 0.239" x 0.220" Microstrip | Z15 | 0.377" x 0.080" Microstrip |
| Z6 | 0.040" x 0.640" Microstrip | Z16 | 0.358" x 0.080" Microstrip |
| Z7 | 0.080" x 0.640" Microstrip | Z17 | 0.361" x 0.080" Microstrip |
| Z8 | 0.276" x 0.640" Microstrip | Z18 | 0.131" x 0.080" Microstrip |
| Z9 | 1.000" x 0.226" Microstrip | Z19 | 0.277" x 0.080" Microstrip |
| Z10 | 0.498" x 0.630" Microstrip | PCB | Arlon GX-0300-55-22, 0.030", $\epsilon_r = 2.55$ |

Figure 14. MRF5S4140HR3(SR3) Test Circuit Schematic — 420-430 MHz

Table 6. MRF5S4140HR3(SR3) Test Circuit Component Designations and Values — 420-430 MHz

| Part | Description | Part Number | Manufacturer |
|--------------------|---|-------------------|------------------|
| B1, B2 | Ferrite Beads, Short | 2743019447 | Fair-Rite |
| C1, C14 | 120 pF Chip Capacitors | 100B121JP500X | ATC |
| C2, C13 | 0.8-8.0 pF Variable Capacitors, Gigatrim | 27291SL | Johanson |
| C3 | 18 pF Chip Capacitor | 100B180JP500X | ATC |
| C4 | 39 pF Chip Capacitor | 100B390JP500X | ATC |
| C5 | 24 pF Chip Capacitor | 100B240JP500X | ATC |
| C6, C7 | 13 pF Chip Capacitors | 100B130JP500X | ATC |
| C8 | 0.02 μ F, 50 V Chip Capacitor | 200B203MW50B | ATC |
| C9, C10 | 22 pF Chip Capacitors | 100B220JP500X | ATC |
| C11 | 1.0 pF Chip Capacitor | 100B1R0JP500X | ATC |
| C12 | 5.6 pF Chip Capacitor | 100B5R6JP500X | ATC |
| C15 | 1.5 pF Chip Capacitor | 100B1R5JP500X | ATC |
| C16 | 47 pF Chip Capacitor | 100B47JP500X | ATC |
| C17 | 0.56 μ F, 50 V Chip Capacitor | C1825C564J5GAC | Kemet |
| C18, C19, C20, C21 | 10 μ F, 35 V Tantalum Chip Capacitors | T491D106K035AS | Kemet |
| C22 | 470 μ F, 63 V Electrolytic Capacitor | SME63V471M12X25LL | United Chemi-Con |
| L1 | 39 nH Inductor | 1812SMS-39N | Coilcraft |
| R1 | 100 Ω , 1/4 W Chip Resistor (1210) | | |

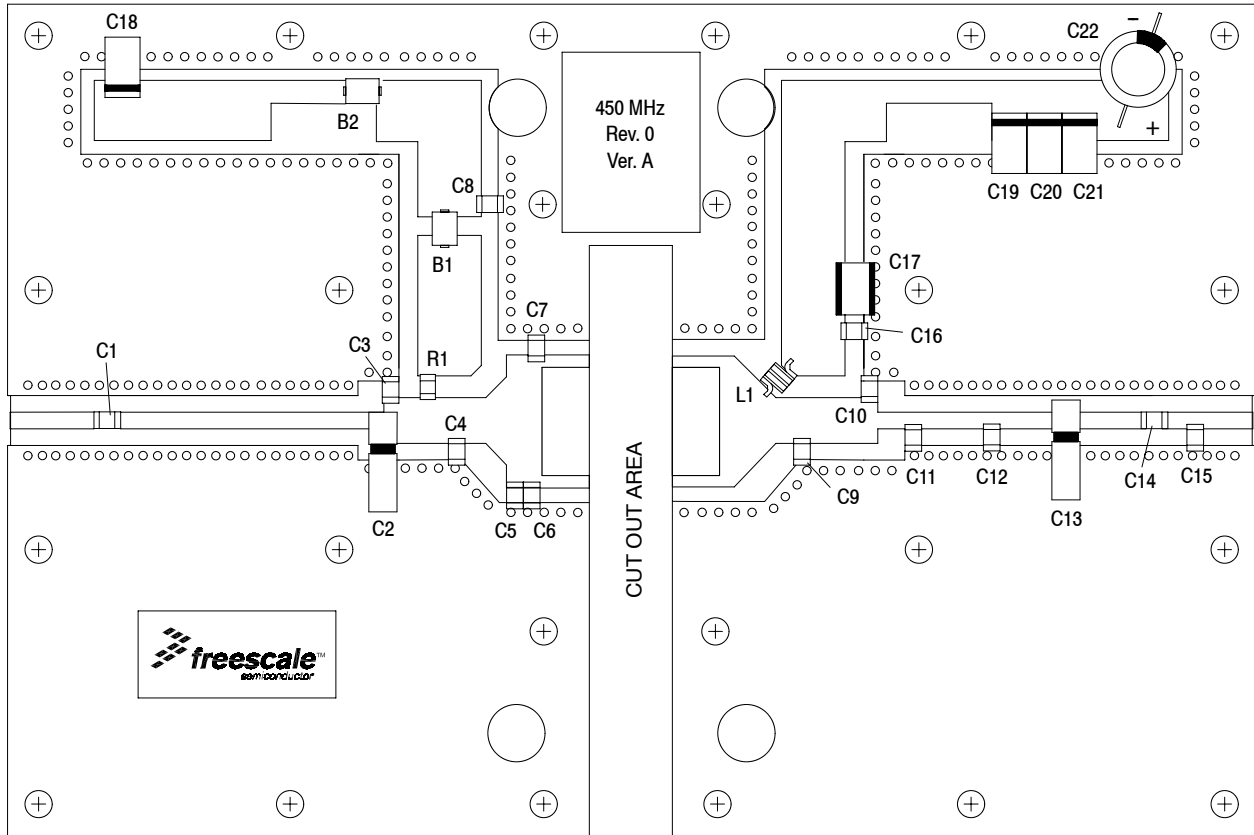

Figure 15. MRF5S4140HR3(SR3) Test Circuit Component Layout — 420-430 MHz

ARCHIVE INFORMATION

ARCHIVE INFORMATION

TYPICAL CHARACTERISTICS — 420-430 MHz

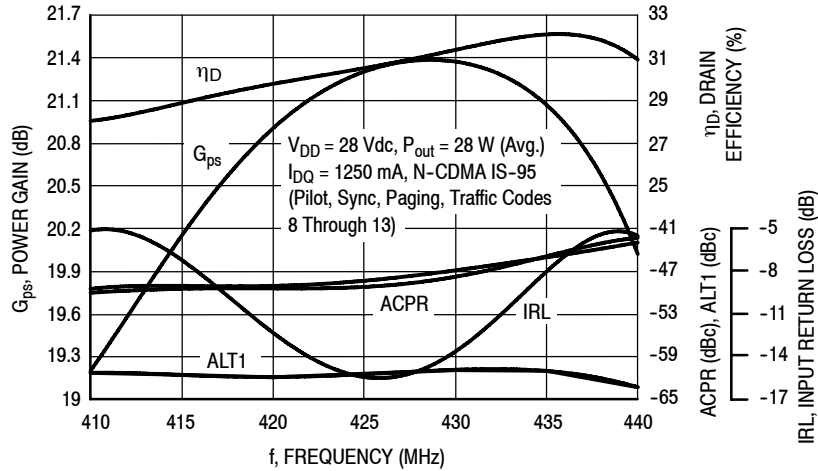

Figure 16. Single-Carrier N-CDMA Broadband Performance @ $P_{out} = 28$ Watts Avg.

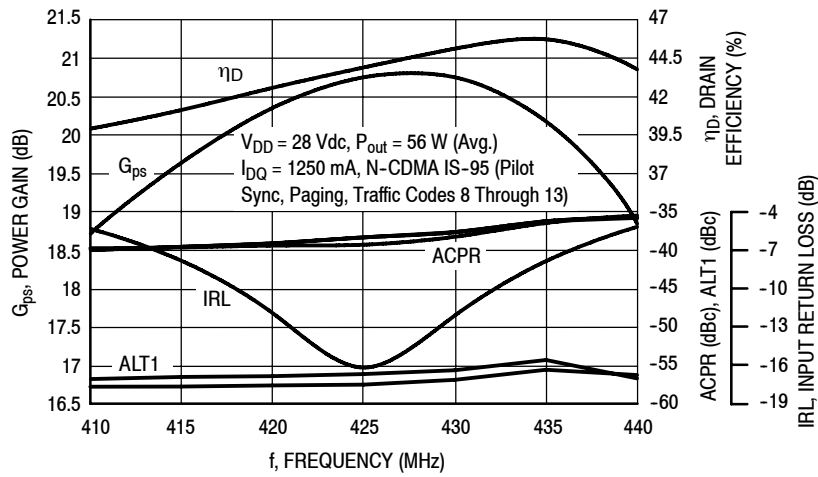
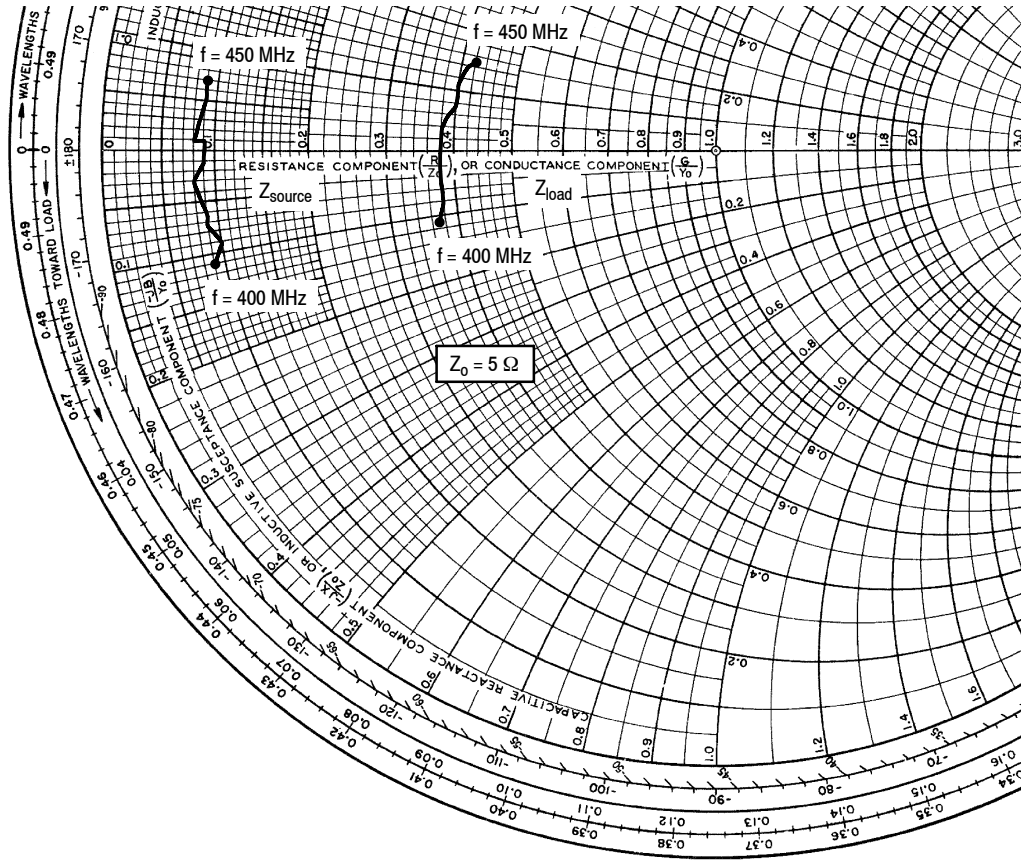

Figure 17. Single-Carrier N-CDMA Broadband Performance @ $P_{out} = 56$ Watts Avg.

ARCHIVE INFORMATION

ARCHIVE INFORMATION



$V_{DD} = 28 \text{ Vdc}$, $I_{DQ} = 1250 \text{ mA}$, $P_{out} = 28 \text{ W Avg.}$

| f MHz | Z_{source} Ω | Z_{load} Ω |
|----------|--------------------------|------------------------|
| 400 | $0.454 - j0.530$ | $1.87 - j0.530$ |
| 405 | $0.476 - j0.435$ | $1.91 - j0.376$ |
| 410 | $0.430 - j0.360$ | $1.88 - j0.276$ |
| 415 | $0.455 - j0.281$ | $1.91 - j0.046$ |
| 420 | $0.419 - j0.153$ | $1.89 - j0.019$ |
| 425 | $0.421 - j0.135$ | $1.92 + j0.128$ |
| 430 | $0.435 - j0.032$ | $1.97 + j0.276$ |
| 435 | $0.426 + j0.048$ | $1.99 + j0.392$ |
| 440 | $0.407 + j0.044$ | $1.99 + j0.537$ |
| 445 | $0.429 + j0.262$ | $2.05 + j0.675$ |
| 450 | $0.452 + j0.341$ | $2.10 + j0.765$ |

Z_{source} = Test circuit impedance as measured from gate to ground.

Z_{load} = Test circuit impedance as measured from drain to ground.

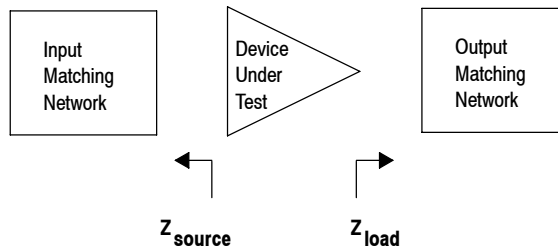
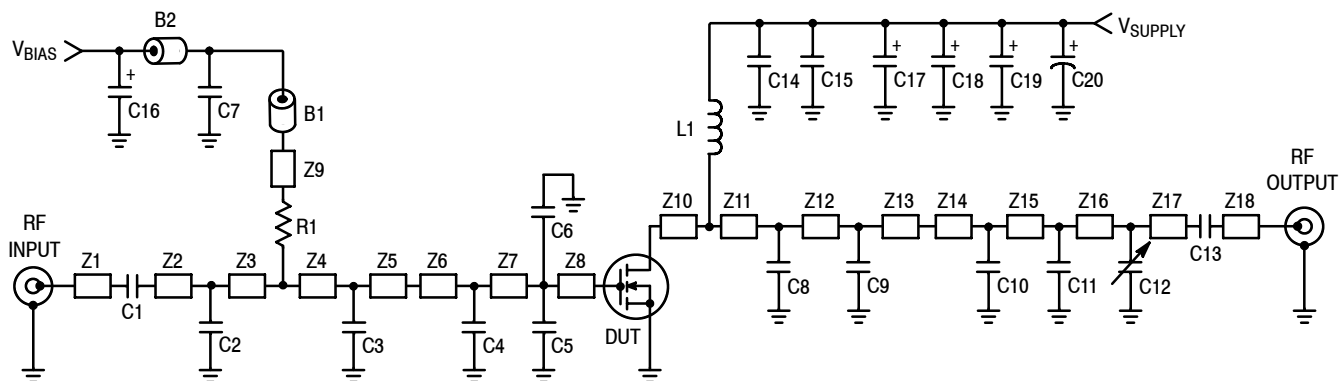

Figure 18. Series Equivalent Source and Load Impedance — 420-430 MHz



| | | | |
|-----|----------------------------|-----|--|
| Z1 | 0.402" x 0.080" Microstrip | Z11 | 0.125" x 0.220" Microstrip |
| Z2 | 1.266" x 0.080" Microstrip | Z12 | 0.324" x 0.220" Microstrip |
| Z3 | 0.211" x 0.220" Microstrip | Z13 | 0.050" x 0.220" Microstrip |
| Z4 | 0.139" x 0.220" Microstrip | Z14 | 0.171" x 0.080" Microstrip |
| Z5 | 0.239" x 0.220" Microstrip | Z15 | 0.377" x 0.080" Microstrip |
| Z6 | 0.040" x 0.640" Microstrip | Z16 | 0.358" x 0.080" Microstrip |
| Z7 | 0.080" x 0.640" Microstrip | Z17 | 0.361" x 0.080" Microstrip |
| Z8 | 0.276" x 0.640" Microstrip | Z18 | 0.408" x 0.080" Microstrip |
| Z9 | 1.000" x 0.226" Microstrip | PCB | Arlon GX-0300-55-22, 0.030", $\epsilon_r = 2.55$ |
| Z10 | 0.498" x 0.630" Microstrip | | |

Figure 19. MRF5S4140HR3(SR3) Test Circuit Schematic — 489-499 MHz

Table 7. MRF5S4140HR3(SR3) Test Circuit Component Designations and Values — 489-499 MHz

| Part | Description | Part Number | Manufacturer |
|--------------------|---|-------------------|------------------|
| B1, B2 | Ferrite Beads, Short | 2743019447 | Fair-Rite |
| C1, C13 | 120 pF Chip Capacitors | 100B121JP500X | ATC |
| C2 | 18 pF Chip Capacitor | 100B180JP500X | ATC |
| C3, C4 | 24 pF Chip Capacitors | 100B240JP500X | ATC |
| C5, C6 | 13 pF Chip Capacitors | 100B130JP500X | ATC |
| C7 | 0.02 μ F, 50 V Chip Capacitor | 200B203MW50B | ATC |
| C8, C9 | 22 pF Chip Capacitors | 100B220JP500X | ATC |
| C10 | 1.0 pF Chip Capacitor | 100B1R0JP500X | ATC |
| C11 | 5.6 pF Chip Capacitor | 100B5R6JP500X | ATC |
| C12 | 0.8-8.0 pF Variable Capacitor, Gigatrim | 27291SL | Johanson |
| C14 | 47 pF Chip Capacitor | 100B47JP500X | ATC |
| C15 | 0.56 μ F, 50 V Chip Capacitor | C1825C564J5GAC | Kemet |
| C16, C17, C18, C19 | 10 μ F, 35 V Tantalum Capacitors | T491D106K035AS | Kemet |
| C20 | 470 μ F, 63 V Electrolytic Capacitor | SME63V471M12X25LL | United Chemi-Con |
| L1 | 39 nH Inductor | 1812SMS-39N | Coilcraft |
| R1 | 100 Ω , 1/4 W Chip Resistor (1210) | | |

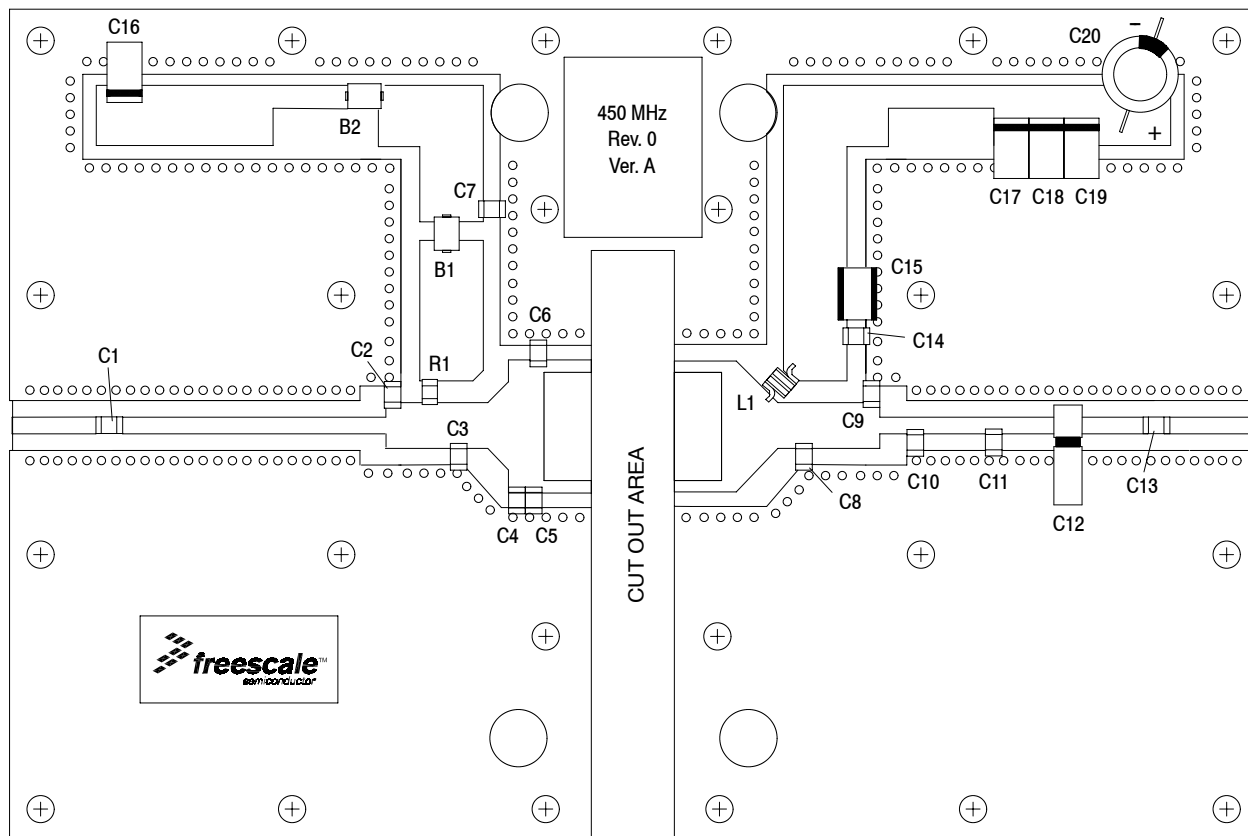

Figure 20. MRF5S4140HR3(SR3) Test Circuit Component Layout — 489-499 MHz

ARCHIVE INFORMATION

ARCHIVE INFORMATION

TYPICAL CHARACTERISTICS — 489-499 MHz

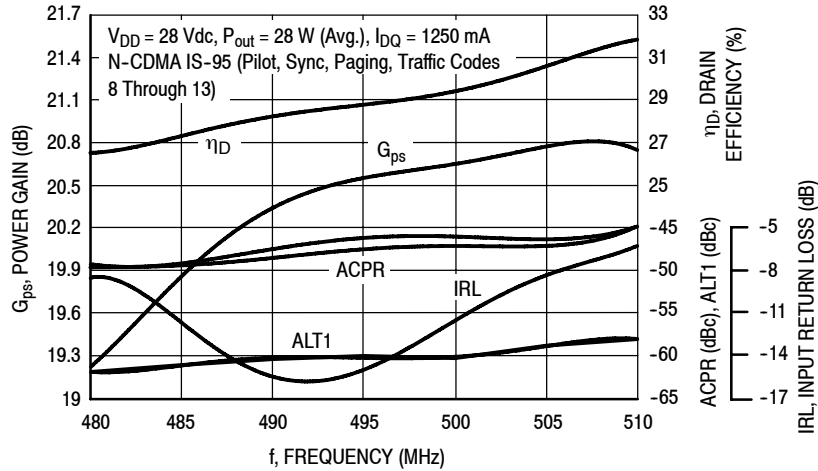

Figure 21. Single-Carrier N-CDMA Broadband Performance @ $P_{out} = 28$ Watts Avg.

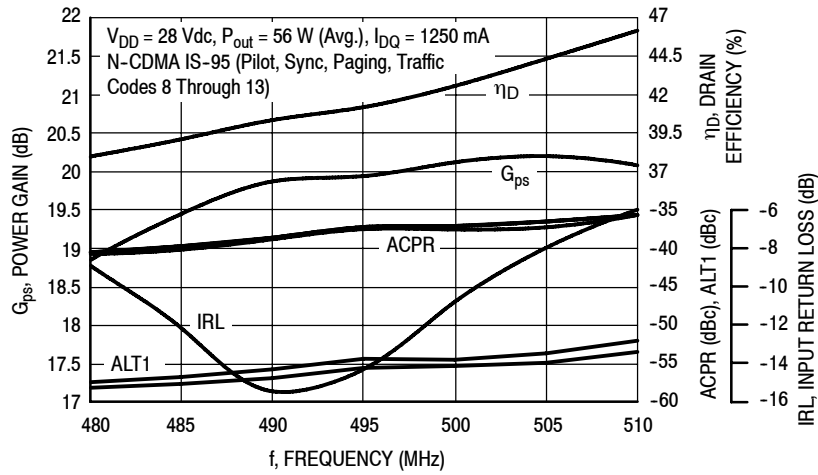
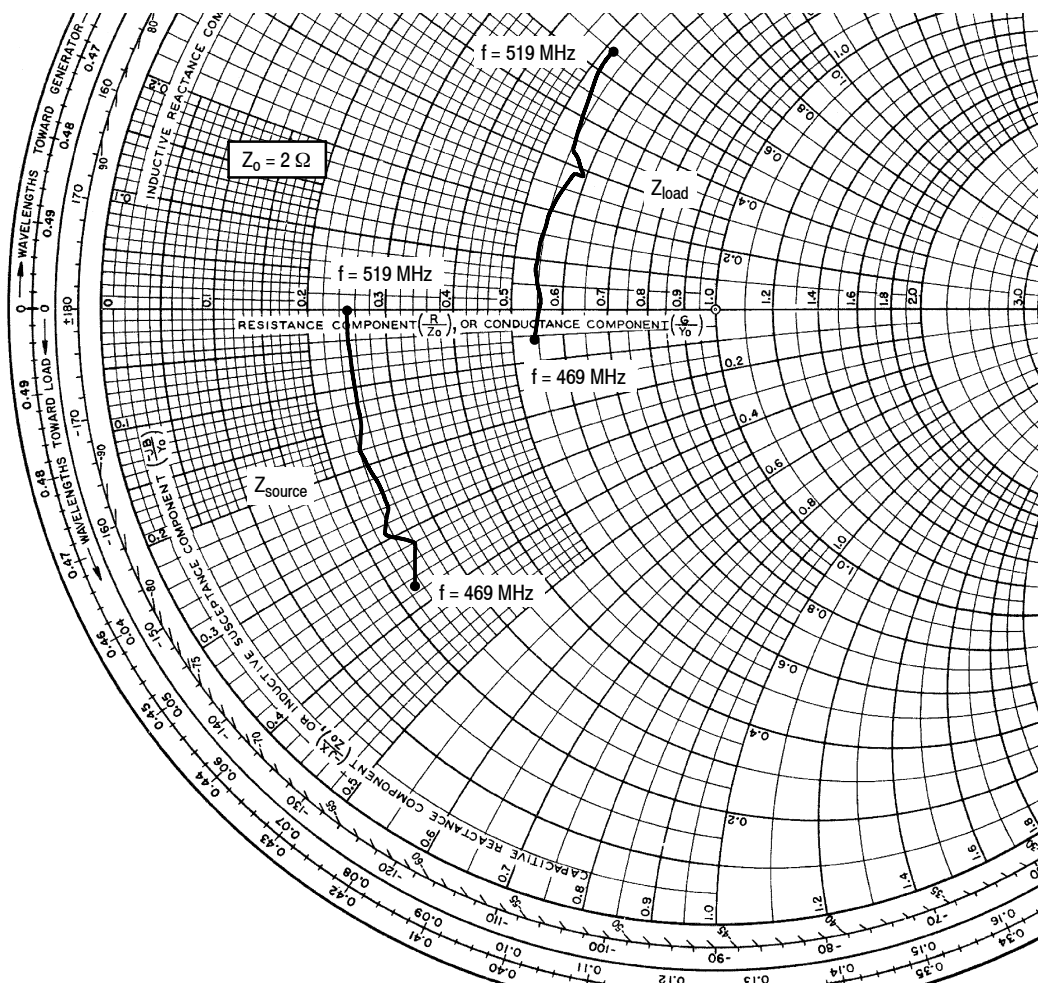

Figure 22. Single-Carrier N-CDMA Broadband Performance @ $P_{out} = 56$ Watts Avg.

ARCHIVE INFORMATION

ARCHIVE INFORMATION



$V_{DD} = 28 \text{ Vdc}$, $I_{DQ} = 1250 \text{ mA}$, $P_{out} = 28 \text{ W Avg}$.

| f MHz | Z_{source} Ω | Z_{load} Ω |
|----------|--------------------------|------------------------|
| 469 | $0.454 - j0.742$ | $1.08 - j0.129$ |
| 474 | $0.510 - j0.637$ | $1.12 + j0.043$ |
| 479 | $0.467 - j0.581$ | $1.07 + j0.160$ |
| 484 | $0.495 - j0.513$ | $1.09 + j0.294$ |
| 489 | $0.495 - j0.457$ | $1.12 + j0.430$ |
| 494 | $0.478 - j0.360$ | $1.16 + j0.573$ |
| 499 | $0.505 - j0.295$ | $1.18 + j0.586$ |
| 504 | $0.502 - j0.249$ | $1.11 + j0.653$ |
| 509 | $0.502 - j0.048$ | $1.07 + j0.810$ |
| 514 | $0.499 + j0.002$ | $1.03 + j1.01$ |
| 519 | $0.502 + j0.003$ | $1.03 + j1.10$ |

Z_{source} = Test circuit impedance as measured from gate to ground.

Z_{load} = Test circuit impedance as measured from drain to ground.

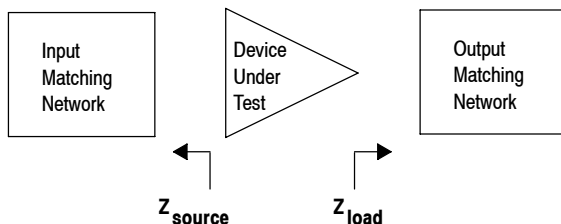
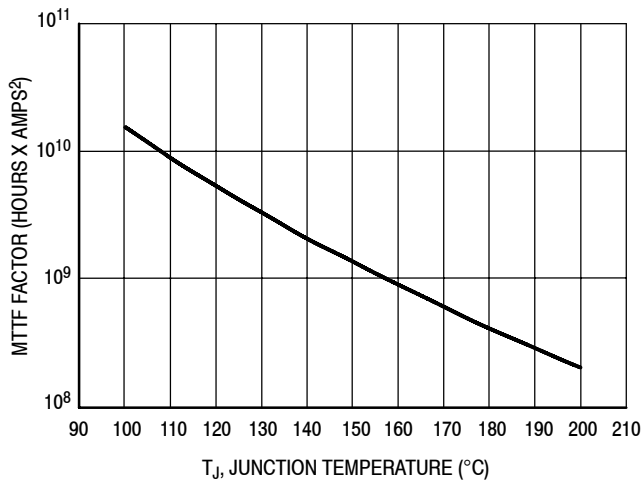

Figure 23. Series Equivalent Source and Load Impedance — 489-499 MHz

TYPICAL CHARACTERISTICS



This above graph displays calculated MTTF in hours x ampere² drain current. Life tests at elevated temperatures have correlated to better than ±10% of the theoretical prediction for metal failure. Divide MTTF factor by I_D^2 for MTTF in a particular application.

Figure 24. MTTF Factor versus Junction Temperature

ARCHIVE INFORMATION

ARCHIVE INFORMATION

N-CDMA TEST SIGNAL

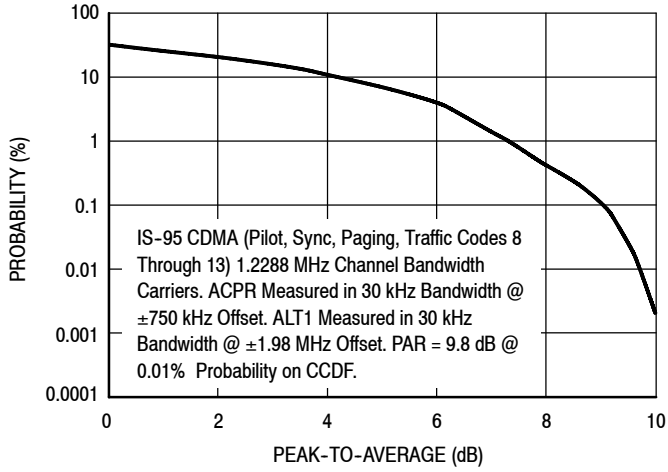

Figure 25. Single-Carrier CCDF N-CDMA

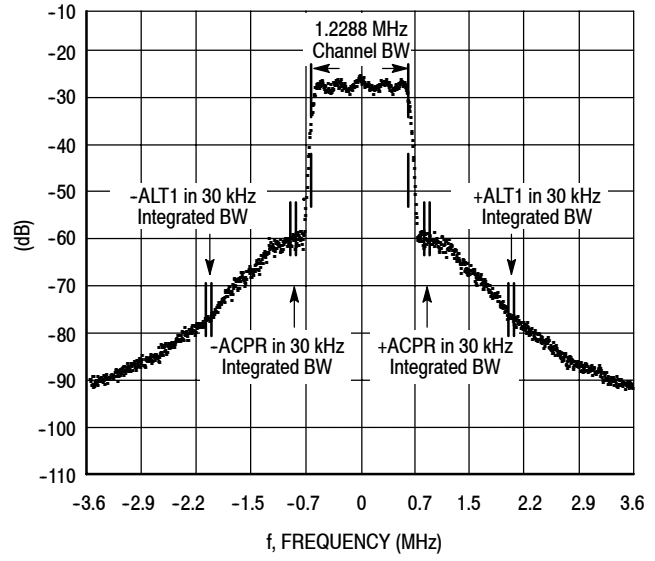
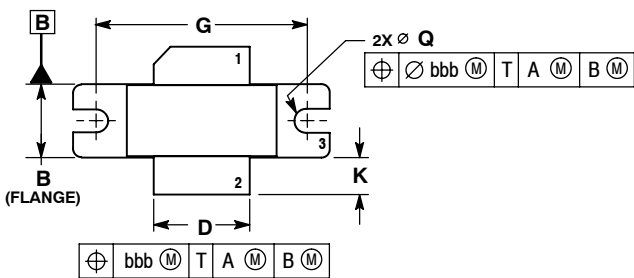

Figure 26. Single-Carrier N-CDMA Spectrum

ARCHIVE INFORMATION

ARCHIVE INFORMATION

PACKAGE DIMENSIONS



- NOTES:
1. DIMENSIONING AND TOLERANCING PER ANSI Y14.5M-1994.
 2. CONTROLLING DIMENSION: INCH.
 3. DELETED
 4. DIMENSION H IS MEASURED 0.030 (0.762) AWAY FROM PACKAGE BODY.

| DIM | INCHES | | MILLIMETERS | |
|-----|--------|-------|-------------|-------|
| | MIN | MAX | MIN | MAX |
| A | 1.335 | 1.345 | 33.91 | 34.16 |
| B | 0.380 | 0.390 | 9.65 | 9.91 |
| C | 0.125 | 0.170 | 3.18 | 4.32 |
| D | 0.495 | 0.505 | 12.57 | 12.83 |
| E | 0.035 | 0.045 | 0.89 | 1.14 |
| F | 0.003 | 0.006 | 0.08 | 0.15 |
| G | 1.100 | BSC | 27.94 | BSC |
| H | 0.057 | 0.067 | 1.45 | 1.70 |
| K | 0.170 | 0.210 | 4.32 | 5.33 |
| M | 0.774 | 0.786 | 19.66 | 19.96 |
| N | 0.772 | 0.788 | 19.60 | 20.00 |
| Q | ∅.118 | ∅.138 | ∅3.00 | ∅3.51 |
| R | 0.365 | 0.375 | 9.27 | 9.53 |
| S | 0.365 | 0.375 | 9.27 | 9.52 |
| aaa | 0.005 | REF | 0.127 | REF |
| bbb | 0.010 | REF | 0.254 | REF |
| ccc | 0.015 | REF | 0.381 | REF |

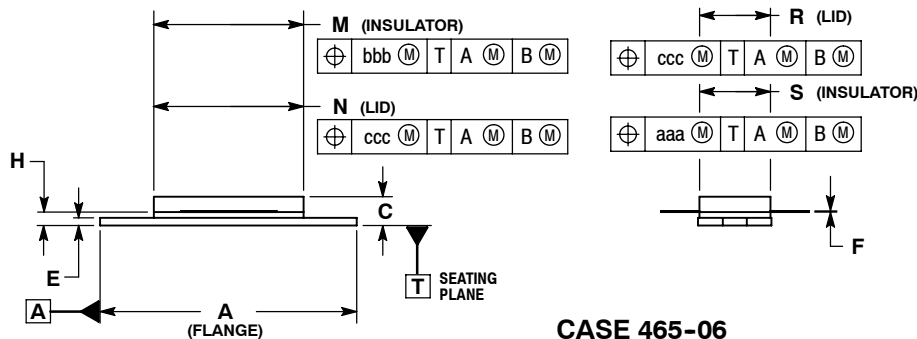

**CASE 465-06
ISSUE G
NI-780
MRF5S4140HR3**

- STYLE 1:
PIN 1. DRAIN
2. GATE
3. SOURCE

ARCHIVE INFORMATION

ARCHIVE INFORMATION

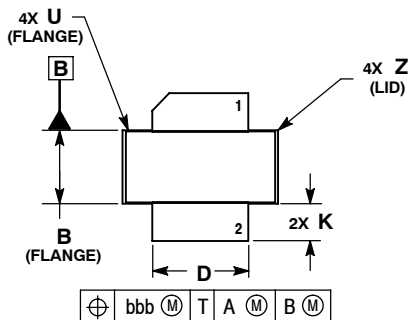

- NOTES:
1. DIMENSIONING AND TOLERANCING PER ANSI Y14.5M-1994.
 2. CONTROLLING DIMENSION: INCH.
 3. DELETED
 4. DIMENSION H IS MEASURED 0.030 (0.762) AWAY FROM PACKAGE BODY.

| DIM | INCHES | | MILLIMETERS | |
|-----|--------|-------|-------------|-------|
| | MIN | MAX | MIN | MAX |
| A | 0.805 | 0.815 | 20.45 | 20.70 |
| B | 0.380 | 0.390 | 9.65 | 9.91 |
| C | 0.125 | 0.170 | 3.18 | 4.32 |
| D | 0.495 | 0.505 | 12.57 | 12.83 |
| E | 0.035 | 0.045 | 0.89 | 1.14 |
| F | 0.003 | 0.006 | 0.08 | 0.15 |
| H | 0.057 | 0.067 | 1.45 | 1.70 |
| K | 0.170 | 0.210 | 4.32 | 5.33 |
| M | 0.774 | 0.786 | 19.61 | 20.02 |
| N | 0.772 | 0.788 | 19.61 | 20.02 |
| R | 0.365 | 0.375 | 9.27 | 9.53 |
| S | 0.365 | 0.375 | 9.27 | 9.52 |
| U | --- | 0.040 | --- | 1.02 |
| Z | --- | 0.030 | --- | 0.76 |
| aaa | 0.005 | REF | 0.127 | REF |
| bbb | 0.010 | REF | 0.254 | REF |
| ccc | 0.015 | REF | 0.381 | REF |

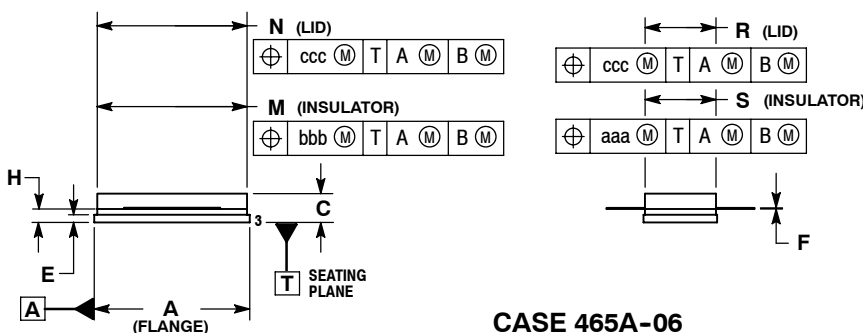

**CASE 465A-06
ISSUE H
NI-780S
MRF5S4140HSR3**

- STYLE 1:
PIN 1. DRAIN
2. GATE
5. SOURCE

How to Reach Us:

Home Page:
www.freescale.com

E-mail:
support@freescale.com

USA/Europe or Locations Not Listed:
Freescale Semiconductor
Technical Information Center, CH370
1300 N. Alma School Road
Chandler, Arizona 85224
+1-800-521-6274 or +1-480-768-2130
support@freescale.com

Europe, Middle East, and Africa:
Freescale Halbleiter Deutschland GmbH
Technical Information Center
Schatzbogen 7
81829 Muenchen, Germany
+44 1296 380 456 (English)
+46 8 52200080 (English)
+49 89 92103 559 (German)
+33 1 69 35 48 48 (French)
support@freescale.com

Japan:
Freescale Semiconductor Japan Ltd.
Headquarters
ARCO Tower 15F
1-8-1, Shimo-Meguro, Meguro-ku,
Tokyo 153-0064
Japan
0120 191014 or +81 3 5437 9125
support.japan@freescale.com

Asia/Pacific:
Freescale Semiconductor Hong Kong Ltd.
Technical Information Center
2 Dai King Street
Tai Po Industrial Estate
Tai Po, N.T., Hong Kong
+800 2666 8080
support.asia@freescale.com

For Literature Requests Only:
Freescale Semiconductor Literature Distribution Center
P.O. Box 5405
Denver, Colorado 80217
1-800-441-2447 or 303-675-2140
Fax: 303-675-2150
LDCForFreescaleSemiconductor@hibbertgroup.com

Information in this document is provided solely to enable system and software implementers to use Freescale Semiconductor products. There are no express or implied copyright licenses granted hereunder to design or fabricate any integrated circuits or integrated circuits based on the information in this document.

Freescale Semiconductor reserves the right to make changes without further notice to any products herein. Freescale Semiconductor makes no warranty, representation or guarantee regarding the suitability of its products for any particular purpose, nor does Freescale Semiconductor assume any liability arising out of the application or use of any product or circuit, and specifically disclaims any and all liability, including without limitation consequential or incidental damages. "Typical" parameters that may be provided in Freescale Semiconductor data sheets and/or specifications can and do vary in different applications and actual performance may vary over time. All operating parameters, including "Typicals", must be validated for each customer application by customer's technical experts. Freescale Semiconductor does not convey any license under its patent rights nor the rights of others. Freescale Semiconductor products are not designed, intended, or authorized for use as components in systems intended for surgical implant into the body, or other applications intended to support or sustain life, or for any other application in which the failure of the Freescale Semiconductor product could create a situation where personal injury or death may occur. Should Buyer purchase or use Freescale Semiconductor products for any such unintended or unauthorized application, Buyer shall indemnify and hold Freescale Semiconductor and its officers, employees, subsidiaries, affiliates, and distributors harmless against all claims, costs, damages, and expenses, and reasonable attorney fees arising out of, directly or indirectly, any claim of personal injury or death associated with such unintended or unauthorized use, even if such claim alleges that Freescale Semiconductor was negligent regarding the design or manufacture of the part.

Freescale™ and the Freescale logo are trademarks of Freescale Semiconductor, Inc. All other product or service names are the property of their respective owners.
© Freescale Semiconductor, Inc. 2006, 2010. All rights reserved.

Looking for pricing, stock, or lifecycle information?

Click below to explore more details on WIN SOURCE:

 [View MRF5S4140HSR3 on WIN SOURCE](#)

 [NXP / Nexperia Information](#)

Optimize Your Supply Chain with WIN SOURCE Solutions

-  Global Sourcing Solution
-  Obsolete Management
-  Cost Control Management
-  Shortage Management
-  Alternative Solution
-  Excess Inventory Management