



**THE DATASHEET OF
MRF6S23140HSR3**



RF Power Field Effect Transistors

N-Channel Enhancement-Mode Lateral MOSFETs

Designed for CDMA base station applications with frequencies from 2300 to 2400 MHz. Suitable for WiMAX, WiBro and multicarrier amplifier applications. To be used in Class AB and Class C WLL applications.

- Typical 2-Carrier W-CDMA Performance: $V_{DD} = 28$ Volts, $I_{DQ} = 1300$ mA, $P_{out} = 28$ Watts Avg., $f = 2390$ MHz, Channel Bandwidth = 3.84 MHz, PAR = 8.5 dB @ 0.01% Probability on CCDF.
 Power Gain — 15.2 dB
 Drain Efficiency — 25%
 IM3 @ 10 MHz Offset — -37 dBc in 3.84 MHz Channel Bandwidth
 ACPR @ 5 MHz Offset — -40 dBc in 3.84 MHz Channel Bandwidth
- Capable of Handling 10:1 VSWR, @ 32 Vdc, 2390 MHz, 140 Watts CW Output Power

Features

- Characterized with Series Equivalent Large-Signal Impedance Parameters
- Internally Matched for Ease of Use
- Qualified Up to a Maximum of 32 V_{DD} Operation
- Integrated ESD Protection
- Designed for Lower Memory Effects and Wide Instantaneous Bandwidth Applications
- RoHS Compliant
- In Tape and Reel. R3 Suffix = 250 Units per 56 mm, 13 inch Reel.

MRF6S23140HR3
MRF6S23140HSR3

2300-2400 MHz, 28 W AVG., 28 V
2 x W-CDMA
LATERAL N-CHANNEL
RF POWER MOSFETS

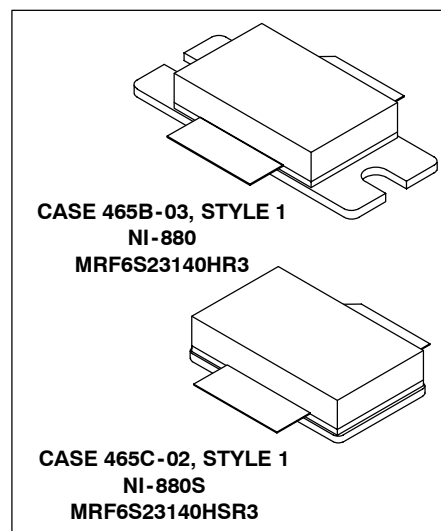

Table 1. Maximum Ratings

| Rating | Symbol | Value | Unit |
|--------------------------------------|-----------|-------------|------|
| Drain-Source Voltage | V_{DSS} | -0.5, +68 | Vdc |
| Gate-Source Voltage | V_{GS} | -0.5, +12 | Vdc |
| Storage Temperature Range | T_{stg} | -65 to +150 | °C |
| Case Operating Temperature | T_C | 150 | °C |
| Operating Junction Temperature (1,2) | T_J | 225 | °C |

Table 2. Thermal Characteristics

| Characteristic | Symbol | Value (2,3) | Unit |
|---|-----------------|--------------|------|
| Thermal Resistance, Junction to Case Case Temperature 82°C, 140 W CW Case Temperature 75°C, 28 W CW | $R_{\theta JC}$ | 0.29 0.33 | °C/W |

Table 3. ESD Protection Characteristics

| Test Methodology | Class |
|---------------------------------------|--------------|
| Human Body Model (per JESD22-A114) | 2 (Minimum) |
| Machine Model (per EIA/JESD22-A115) | A (Minimum) |
| Charge Device Model (per JESD22-C101) | IV (Minimum) |

1. Continuous use at maximum temperature will affect MTTF.
2. MTTF calculator available at <http://www.freescale.com/rf>. Select Software & Tools/Development Tools/Calculators to access MTTF calculators by product.
3. Refer to AN1955, *Thermal Measurement Methodology of RF Power Amplifiers*. Go to <http://www.freescale.com/rf>. Select Documentation/Application Notes - AN1955.

Table 4. Electrical Characteristics ($T_C = 25^\circ\text{C}$ unless otherwise noted)

| Characteristic | Symbol | Min | Typ | Max | Unit |
|--|--------------|-----|------|-----|-----------------|
| Off Characteristics | | | | | |
| Zero Gate Voltage Drain Leakage Current ($V_{DS} = 68\text{ Vdc}$, $V_{GS} = 0\text{ Vdc}$) | I_{DSS} | — | — | 10 | μAdc |
| Zero Gate Voltage Drain Leakage Current ($V_{DS} = 28\text{ Vdc}$, $V_{GS} = 0\text{ Vdc}$) | I_{DSS} | — | — | 1 | μAdc |
| Gate-Source Leakage Current ($V_{GS} = 5\text{ Vdc}$, $V_{DS} = 0\text{ Vdc}$) | I_{GSS} | — | — | 500 | nAdc |
| On Characteristics | | | | | |
| Gate Threshold Voltage ($V_{DS} = 10\text{ Vdc}$, $I_D = 300\ \mu\text{Adc}$) | $V_{GS(th)}$ | 1 | 2 | 3 | Vdc |
| Gate Quiescent Voltage ($V_{DD} = 28\text{ Vdc}$, $I_D = 1300\ \text{mAdc}$, Measured in Functional Test) | $V_{GS(Q)}$ | 2 | 2.8 | 4 | Vdc |
| Drain-Source On-Voltage ($V_{GS} = 10\text{ Vdc}$, $I_D = 3\ \text{Adc}$) | $V_{DS(on)}$ | 0.1 | 0.21 | 0.3 | Vdc |
| Dynamic Characteristics ⁽¹⁾ | | | | | |
| Reverse Transfer Capacitance ($V_{DS} = 28\text{ Vdc} \pm 30\ \text{mV(rms)ac}$ @ 1 MHz, $V_{GS} = 0\text{ Vdc}$) | C_{rss} | — | 2 | — | pF |
| Functional Tests (In Freescale Test Fixture, 50 ohm system) $V_{DD} = 28\text{ Vdc}$, $I_{DQ} = 1300\ \text{mA}$, $P_{out} = 28\ \text{W Avg.}$, $f = 2390\ \text{MHz}$, 2-Carrier W-CDMA, 3.84 MHz Channel Bandwidth Carriers. ACPR measured in 3.84 MHz Channel Bandwidth @ $\pm 5\ \text{MHz}$ Offset. IM3 measured in 3.84 MHz Bandwidth @ $\pm 10\ \text{MHz}$ Offset. PAR = 8.5 dB @ 0.01% Probability on CCDF. | | | | | |
| Power Gain | G_{ps} | 13 | 15.2 | 17 | dB |
| Drain Efficiency | η_D | 23 | 25 | — | % |
| Intermodulation Distortion | IM3 | — | -37 | -35 | dBc |
| Adjacent Channel Power Ratio | ACPR | — | -40 | -38 | dBc |
| Input Return Loss | IRL | — | -15 | — | dB |

1. Part internally matched both on input and output.

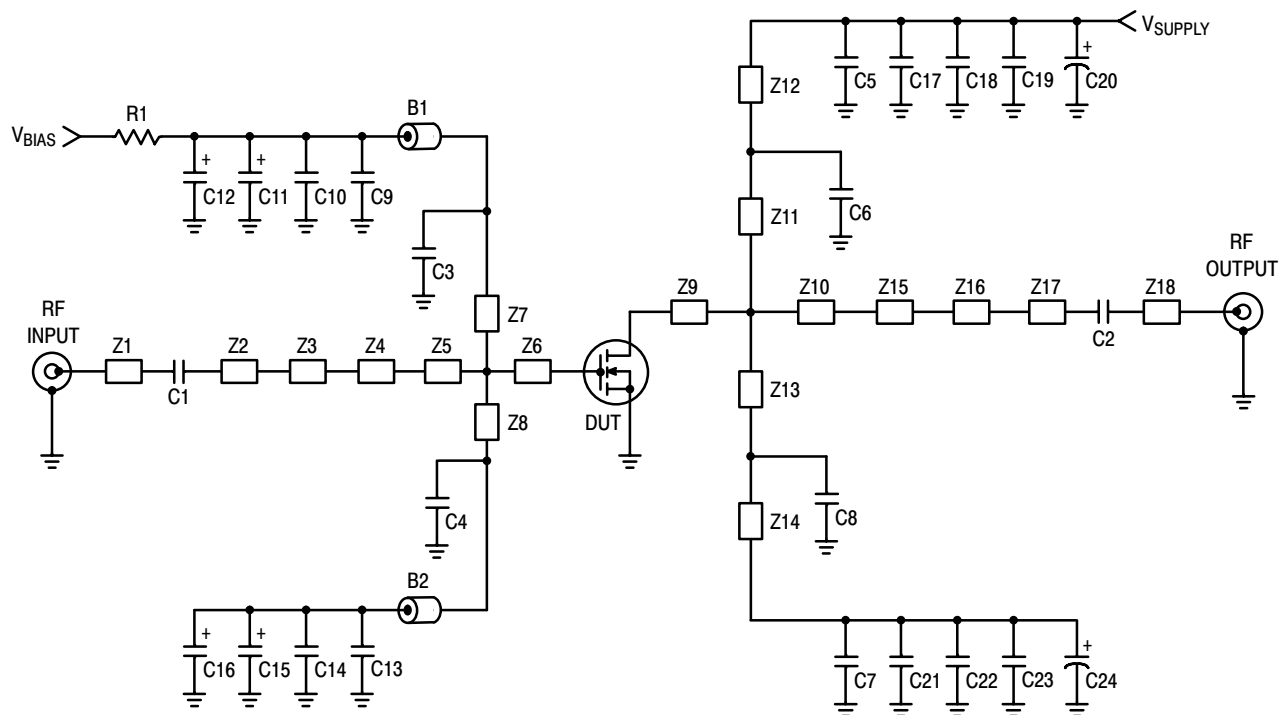

| | | | |
|--------|----------------------------|----------|---|
| Z1 | 0.678" x 0.068" Microstrip | Z10 | 0.193" x 1.170" Microstrip |
| Z2 | 0.420" x 0.068" Microstrip | Z11, Z13 | 0.712" x 0.095" Microstrip |
| Z3 | 0.845" x 0.200" Microstrip | Z12, Z14 | 0.098" x 0.095" Microstrip |
| Z4 | 0.175" x 0.530" Microstrip | Z15 | 0.115" x 0.550" Microstrip |
| Z5, Z6 | 0.025" x 0.530" Microstrip | Z16 | 0.250" x 0.110" Microstrip |
| Z7 | 0.514" x 0.050" Microstrip | Z17 | 0.539" x 0.068" Microstrip |
| Z8 | 0.507" x 0.050" Microstrip | Z18 | 0.956" x 0.068" Microstrip |
| Z9 | 0.097" x 1.170" Microstrip | PCB | Taconic RF-35, 0.030", $\epsilon_r = 3.5$ |

Figure 1. MRF6S23140HR3(SR3) Test Circuit Schematic

Table 5. MRF6S23140HR3(SR3) Test Circuit Component Designations and Values

| Part | Description | Part Number | Manufacturer |
|--------------------------------|---|--------------------|--------------|
| B1, B2 | Ferrite Beads, Short | 2743019447 | Fair-Rite |
| C1, C2, C3, C4, C5, C6, C7, C8 | 5.6 pF Chip Capacitors | ATC100B5R6CT500XT | ATC |
| C9, C13 | 0.01 μ F, 100 V Chip Capacitors | C1825C103J1RAC | Kemet |
| C10, C14, C17, C21 | 2.2 μ F, 50 V Chip Capacitors | C1825C225J5RAC | Kemet |
| C11, C15 | 22 μ F, 25 V Tantalum Chip Capacitors | T491D226K025AT | Kemet |
| C12, C16 | 47 μ F, 16 V Tantalum Chip Capacitors | T491D476K016AT | Kemet |
| C18, C19, C22, C23 | 10 μ F, 50 V Chip Capacitors | GRM55DR61H106KA88B | Murata |
| C20, C24 | 330 μ F, 63 V Electrolytic Capacitors | EMVY630GTR331MMH0S | Chemicon |
| R1 | 10 Ω , 1/4 W Chip Resistor | CRCW120610R0FKEA | Vishay |

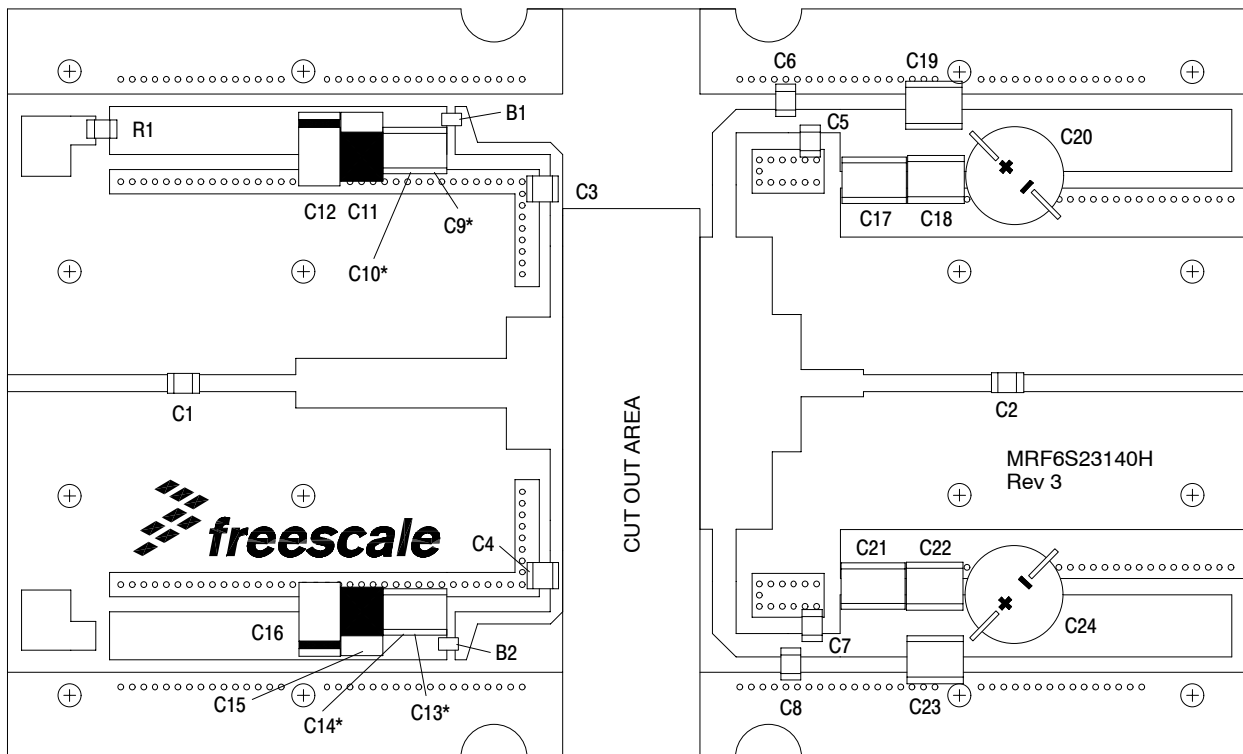

* Stacked

Figure 2. MRF6S23140HR3(SR3) Test Circuit Component Layout

TYPICAL CHARACTERISTICS

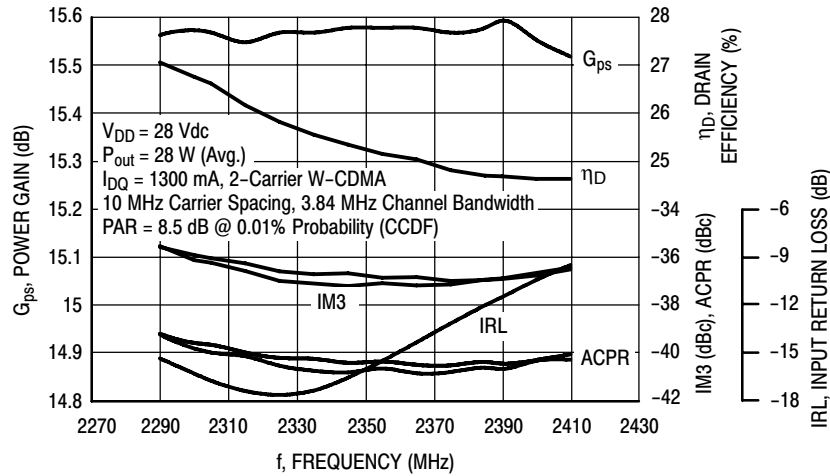

Figure 3. 2-Carrier W-CDMA Broadband Performance @ $P_{out} = 28$ Watts Avg.

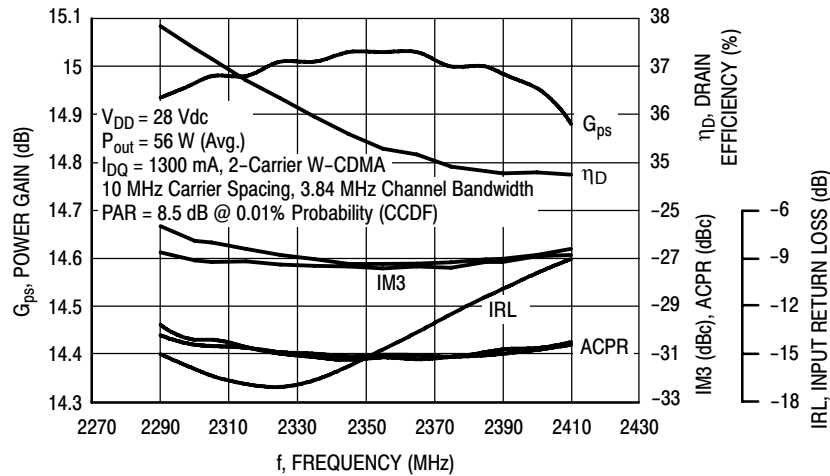

Figure 4. 2-Carrier W-CDMA Broadband Performance @ $P_{out} = 56$ Watts Avg.

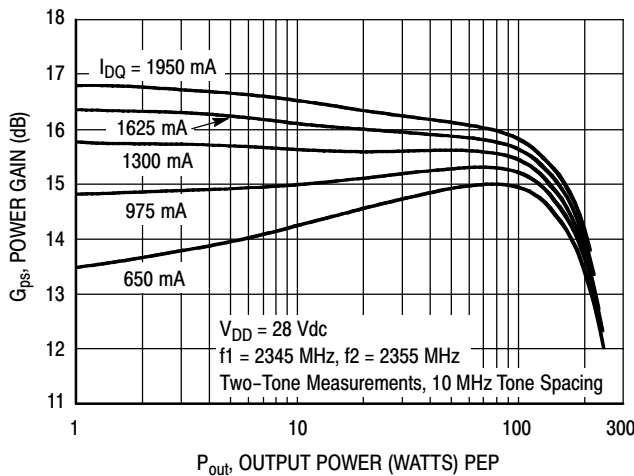

Figure 5. Two-Tone Power Gain versus Output Power

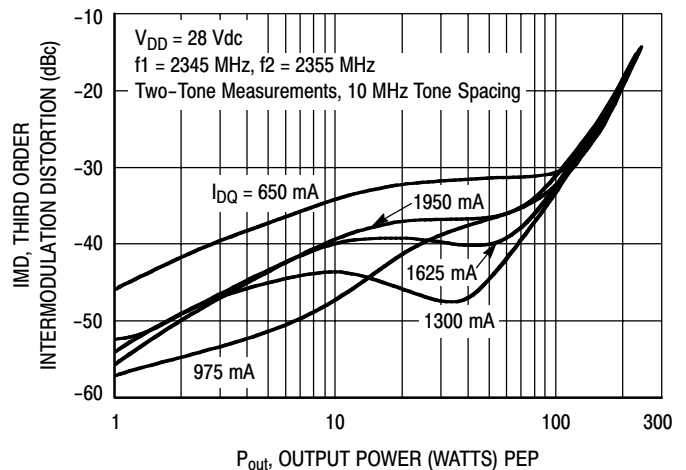

Figure 6. Third Order Intermodulation Distortion versus Output Power

TYPICAL CHARACTERISTICS

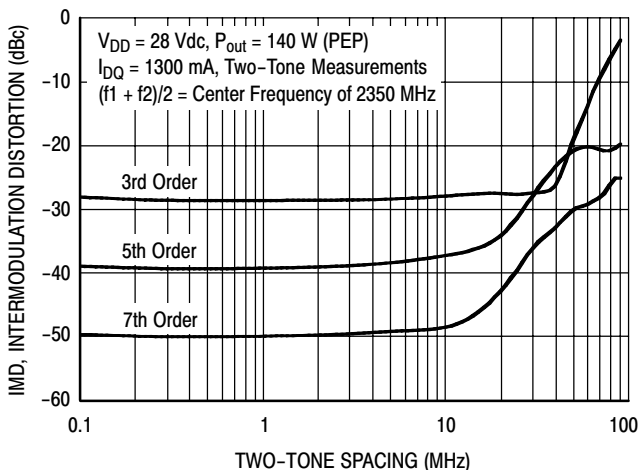

Figure 7. Intermodulation Distortion Products versus Tone Spacing

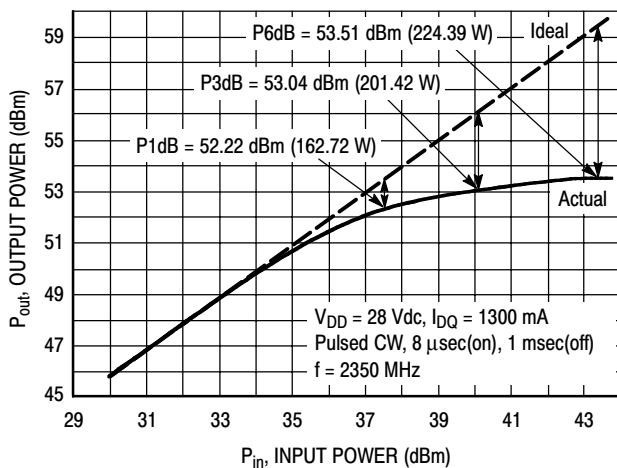

Figure 8. Pulsed CW Output Power versus Input Power

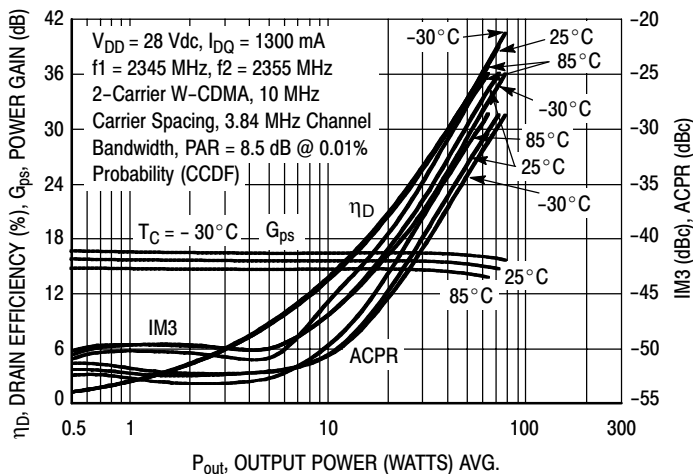

Figure 9. 2-Carrier W-CDMA ACPR, IM3, Power Gain and Drain Efficiency versus Output Power

TYPICAL CHARACTERISTICS

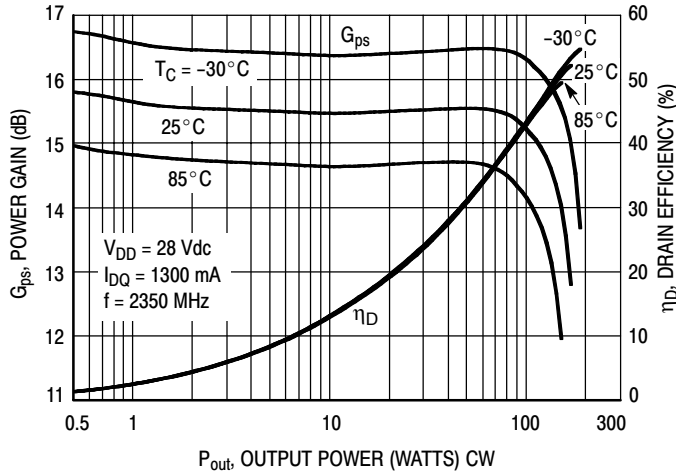

Figure 10. Power Gain and Drain Efficiency versus Output Power

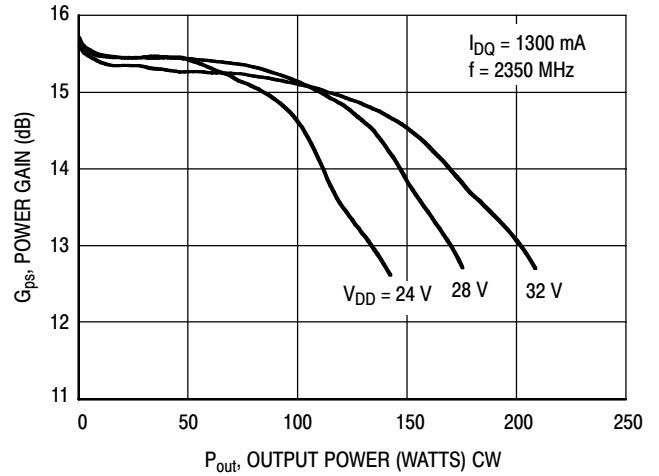
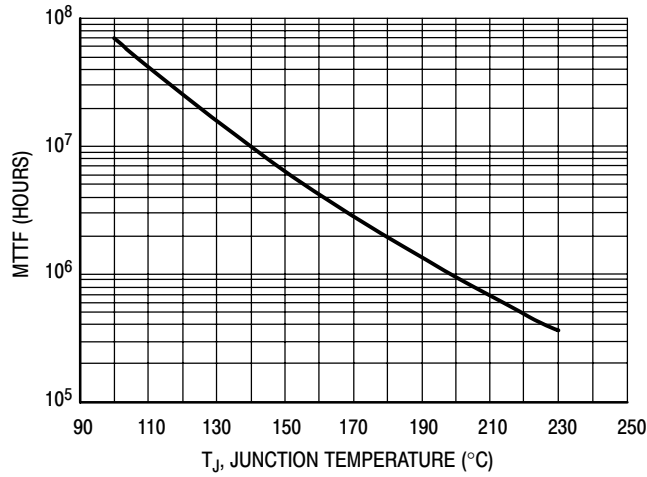

Figure 11. Power Gain versus Output Power



This above graph displays calculated MTTF in hours when the device is operated at $V_{DD} = 28$ Vdc, $P_{out} = 28$ W Avg., and $\eta_D = 25\%$.

MTTF calculator available at <http://www.freescale.com/rf>. Select Software & Tools/Development Tools/Calculators to access MTTF calculators by product.

Figure 12. MTTF Factor versus Junction Temperature

W-CDMA TEST SIGNAL

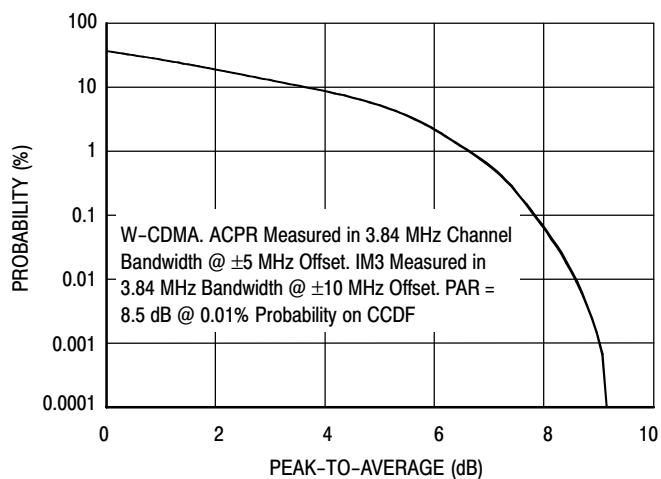

Figure 13. CCDF W-CDMA 3GPP, Test Model 1, 64 DPCH, 67% Clipping, Single-Carrier Test Signal

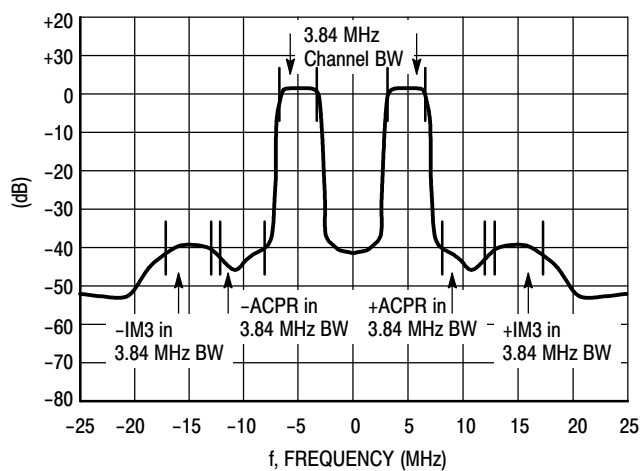
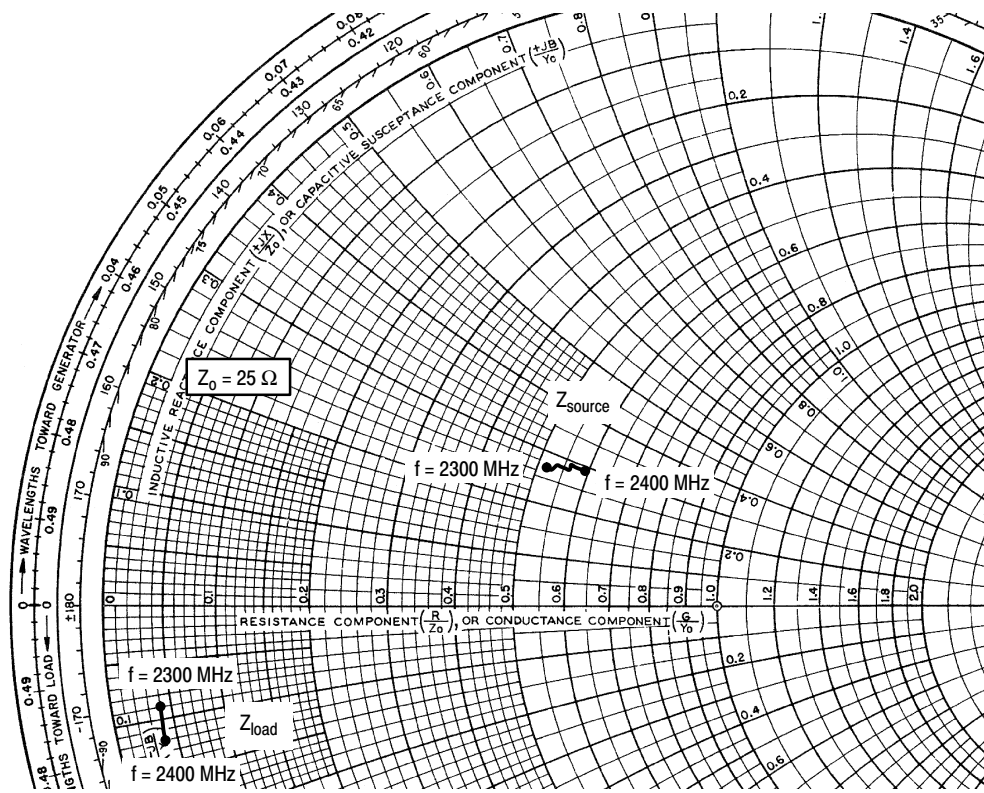

Figure 14. 2-Carrier W-CDMA Spectrum



$V_{DD} = 28 \text{ Vdc}$, $I_{DQ} = 1300 \text{ mA}$, $P_{out} = 28 \text{ W Avg.}$

| f MHz | Z_{source} Ω | Z_{load} Ω |
|----------|--------------------------|------------------------|
| 2300 | $12.92 + j6.65$ | $1.05 - j2.88$ |
| 2310 | $13.06 + j6.73$ | $1.04 - j2.82$ |
| 2320 | $13.21 + j6.80$ | $1.03 - j2.76$ |
| 2330 | $13.37 + j6.87$ | $1.01 - j2.70$ |
| 2340 | $13.53 + j6.94$ | $1.00 - j2.64$ |
| 2350 | $13.70 + j7.01$ | $0.99 - j2.58$ |
| 2360 | $13.88 + j7.08$ | $0.97 - j2.52$ |
| 2370 | $14.06 + j7.14$ | $0.96 - j2.46$ |
| 2380 | $14.25 + j7.21$ | $0.95 - j2.40$ |
| 2390 | $14.45 + j7.27$ | $0.94 - j2.34$ |
| 2400 | $14.66 + j7.33$ | $0.93 - j2.28$ |

Z_{source} = Test circuit impedance as measured from gate to ground.

Z_{load} = Test circuit impedance as measured from drain to ground.

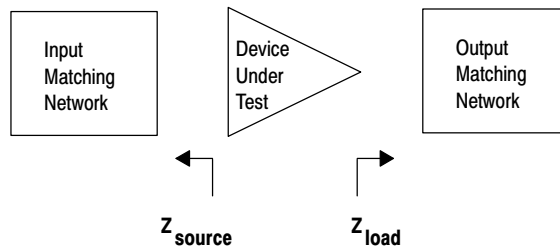

Figure 15. Series Equivalent Source and Load Impedance

PRODUCT DOCUMENTATION

Refer to the following documents to aid your design process.

Application Notes

- AN1955: Thermal Measurement Methodology of RF Power Amplifiers

Engineering Bulletins

- EB212: Using Data Sheet Impedances for RF LDMOS Devices

REVISION HISTORY

The following table summarizes revisions to this document.

| Revision | Date | Description |
|----------|-----------|---|
| 2 | Dec. 2008 | <ul style="list-style-type: none"> • Modified data sheet to reflect RF Test Reduction described in Product and Process Change Notification number, PCN13232, p. 1, 2 • Removed Lower Thermal Resistance and Low Gold Plating bullets from Features section as functionality is standard, p. 1 • Operating Junction Temperature increased from 200°C to 225°C in Maximum Ratings table and related “Continuous use at maximum temperature will affect MTTF” footnote added, p. 1 • Corrected V_{DS} to V_{DD} in the RF test condition voltage callout for $V_{GS(Q)}$, and added “Measured in Functional Test”, On Characteristics table, p. 2 • Updated Part Numbers in Table 5, Component Designations and Values, to RoHS compliant part numbers, p. 3 • Removed lower voltage tests from Fig. 11, Power Gain versus Output Power, due to fixed tuned fixture limitations, p. 7 • Replaced Fig. 12, MTTF versus Junction Temperature with updated graph. Removed Amps² and listed operating characteristics and location of MTTF calculator for device, p. 7 • Added Product Documentation and Revision History, p. 11 |

How to Reach Us:

Home Page:

www.freescale.com

Web Support:

<http://www.freescale.com/support>

USA/Europe or Locations Not Listed:

Freescale Semiconductor, Inc.
Technical Information Center, EL516
2100 East Elliot Road
Tempe, Arizona 85284
1-800-521-6274 or +1-480-768-2130
www.freescale.com/support

Europe, Middle East, and Africa:

Freescale Halbleiter Deutschland GmbH
Technical Information Center
Schatzbogen 7
81829 Muenchen, Germany
+44 1296 380 456 (English)
+46 8 52200080 (English)
+49 89 92103 559 (German)
+33 1 69 35 48 48 (French)
www.freescale.com/support

Japan:

Freescale Semiconductor Japan Ltd.
Headquarters
ARCO Tower 15F
1-8-1, Shimo-Meguro, Meguro-ku,
Tokyo 153-0064
Japan
0120 191014 or +81 3 5437 9125
support.japan@freescale.com

Asia/Pacific:

Freescale Semiconductor China Ltd.
Exchange Building 23F
No. 118 Jianguo Road
Chaoyang District
Beijing 100022
China
+86 10 5879 8000
support.asia@freescale.com

For Literature Requests Only:

Freescale Semiconductor Literature Distribution Center
P.O. Box 5405
Denver, Colorado 80217
1-800-441-2447 or +1-303-675-2140
Fax: +1-303-675-2150
LDCForFreescaleSemiconductor@hibbertgroup.com

Information in this document is provided solely to enable system and software implementers to use Freescale Semiconductor products. There are no express or implied copyright licenses granted hereunder to design or fabricate any integrated circuits or integrated circuits based on the information in this document.

Freescale Semiconductor reserves the right to make changes without further notice to any products herein. Freescale Semiconductor makes no warranty, representation or guarantee regarding the suitability of its products for any particular purpose, nor does Freescale Semiconductor assume any liability arising out of the application or use of any product or circuit, and specifically disclaims any and all liability, including without limitation consequential or incidental damages. "Typical" parameters that may be provided in Freescale Semiconductor data sheets and/or specifications can and do vary in different applications and actual performance may vary over time. All operating parameters, including "Typicals", must be validated for each customer application by customer's technical experts. Freescale Semiconductor does not convey any license under its patent rights nor the rights of others. Freescale Semiconductor products are not designed, intended, or authorized for use as components in systems intended for surgical implant into the body, or other applications intended to support or sustain life, or for any other application in which the failure of the Freescale Semiconductor product could create a situation where personal injury or death may occur. Should Buyer purchase or use Freescale Semiconductor products for any such unintended or unauthorized application, Buyer shall indemnify and hold Freescale Semiconductor and its officers, employees, subsidiaries, affiliates, and distributors harmless against all claims, costs, damages, and expenses, and reasonable attorney fees arising out of, directly or indirectly, any claim of personal injury or death associated with such unintended or unauthorized use, even if such claim alleges that Freescale Semiconductor was negligent regarding the design or manufacture of the part.

Freescale™ and the Freescale logo are trademarks of Freescale Semiconductor, Inc. All other product or service names are the property of their respective owners.

© Freescale Semiconductor, Inc. 2006, 2008. All rights reserved.

Looking for pricing, stock, or lifecycle information?

Click below to explore more details on WIN SOURCE:

 [View MRF6S23140HSR3 on WIN SOURCE](#)

 [NXP / Nexperia Information](#)

Optimize Your Supply Chain with WIN SOURCE Solutions

-  Global Sourcing Solution
-  Obsolete Management
-  Cost Control Management
-  Shortage Management
-  Alternative Solution
-  Excess Inventory Management