



**THE DATASHEET OF
MRF6S9160HR3**



MRF6S9160HR3/HSR3 replaced by MRFE6S9160HR3/HSR3. Refer to Device Migration PCN12895 for more details.

RF Power Field Effect Transistors

N-Channel Enhancement-Mode Lateral MOSFETs

Designed for N-CDMA, GSM and GSM EDGE base station applications with frequencies from 865 to 960 MHz. Suitable for multicarrier amplifier applications.

- Typical Single-Carrier N-CDMA Performance @ 880 MHz: $V_{DD} = 28$ Volts, $I_{DQ} = 1200$ mA, $P_{out} = 35$ Watts Avg., IS-95 CDMA (Pilot, Sync, Paging, Traffic Codes 8 Through 13) Channel Bandwidth = 1.2288 MHz. PAR = 9.8 dB @ 0.01% Probability on CCDF.
 Power Gain — 20.9 dB
 Drain Efficiency — 30.5%
 ACPR @ 750 kHz Offset — -46.8 dBc in 30 kHz Bandwidth

GSM EDGE Application

- Typical GSM EDGE Performance: $V_{DD} = 28$ Volts, $I_{DQ} = 1200$ mA, $P_{out} = 76$ Watts Avg., Full Frequency Band (865-895 MHz)
 Power Gain — 20 dB
 Drain Efficiency — 45%
 Spectral Regrowth @ 400 kHz Offset = -66 dBc
 Spectral Regrowth @ 600 kHz Offset = -75 dBc
 EVM — 2% rms

GSM Application

- Typical GSM Performance: $V_{DD} = 28$ Volts, $I_{DQ} = 1200$ mA, $P_{out} = 160$ Watts, Full Frequency Band (921-960 MHz)
 Power Gain — 20 dB
 Drain Efficiency — 58%
- Capable of Handling 10:1 VSWR, @ 28 Vdc, 880 MHz, 160 Watts CW Output Power

Features

- Characterized with Series Equivalent Large-Signal Impedance Parameters
- Internally Matched for Ease of Use
- Qualified Up to a Maximum of 32 V_{DD} Operation
- Integrated ESD Protection
- RoHS Compliant
- In Tape and Reel. R3 Suffix = 250 Units per 56 mm, 13 inch Reel.

Table 1. Maximum Ratings

Rating	Symbol	Value	Unit
Drain-Source Voltage	V_{DSS}	-0.5, +68	Vdc
Gate-Source Voltage	V_{GS}	-0.5, +12	Vdc
Storage Temperature Range	T_{stg}	-65 to +150	°C
Case Operating Temperature	T_C	150	°C
Operating Junction Temperature (1,2)	T_J	225	°C

Table 2. Thermal Characteristics

Characteristic	Symbol	Value (2,3)	Unit
Thermal Resistance, Junction to Case Case Temperature 81°C, 160 W CW Case Temperature 73°C, 35 W CW	$R_{\theta JC}$	0.31 0.33	°C/W

1. Continuous use at maximum temperature will affect MTTF.
2. MTTF calculator available at <http://www.freescale.com/rf>. Select Software & Tools/Development Tools/Calculators to access MTTF calculators by product.
3. Refer to AN1955, *Thermal Measurement Methodology of RF Power Amplifiers*. Go to <http://www.freescale.com/rf>. Select Documentation/Application Notes - AN1955.

MRF6S9160HR3
MRF6S9160HSR3

880 MHz, 35 W AVG., 28 V
SINGLE N-CDMA
LATERAL N-CHANNEL
RF POWER MOSFETs

CASE 465-06, STYLE 1
NI-780
MRF6S9160HR3

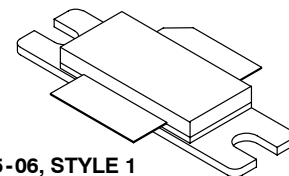

CASE 465A-06, STYLE 1
NI-780S
MRF6S9160HSR3

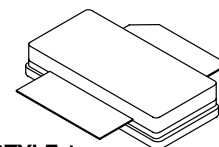

ARCHIVE INFORMATION

ARCHIVE INFORMATION

Table 3. ESD Protection Characteristics

Test Methodology	Class
Human Body Model (per JESD22-A114)	1A (Minimum)
Machine Model (per EIA/JESD22-A115)	A (Minimum)
Charge Device Model (per JESD22-C101)	IV (Minimum)

Table 4. Electrical Characteristics ($T_C = 25^\circ\text{C}$ unless otherwise noted)

Characteristic	Symbol	Min	Typ	Max	Unit
Off Characteristics					
Zero Gate Voltage Drain Leakage Current ($V_{DS} = 68\text{ Vdc}$, $V_{GS} = 0\text{ Vdc}$)	I_{DSS}	—	—	10	μAdc
Zero Gate Voltage Drain Leakage Current ($V_{DS} = 28\text{ Vdc}$, $V_{GS} = 0\text{ Vdc}$)	I_{DSS}	—	—	1	μAdc
Gate-Source Leakage Current ($V_{GS} = 5\text{ Vdc}$, $V_{DS} = 0\text{ Vdc}$)	I_{GSS}	—	—	1	μAdc
On Characteristics					
Gate Threshold Voltage ($V_{DS} = 10\text{ Vdc}$, $I_D = 525\ \mu\text{Adc}$)	$V_{GS(th)}$	1	2	3	Vdc
Gate Quiescent Voltage ($V_{DD} = 28\text{ Vdc}$, $I_D = 1200\text{ mAdc}$, Measured in Functional Test)	$V_{GS(Q)}$	2	3	4	Vdc
Drain-Source On-Voltage ($V_{GS} = 10\text{ Vdc}$, $I_D = 3.6\text{ Adc}$)	$V_{DS(on)}$	0.1	0.2	0.3	Vdc
Dynamic Characteristics (1)					
Output Capacitance ($V_{DS} = 28\text{ Vdc} \pm 30\text{ mV(rms)ac}$ @ 1 MHz, $V_{GS} = 0\text{ Vdc}$)	C_{oss}	—	80.2	—	pF
Reverse Transfer Capacitance ($V_{DS} = 28\text{ Vdc} \pm 30\text{ mV(rms)ac}$ @ 1 MHz, $V_{GS} = 0\text{ Vdc}$)	C_{rss}	—	2.2	—	pF

Functional Tests (In Freescale Test Fixture, 50 ohm system) $V_{DD} = 28\text{ Vdc}$, $I_{DQ} = 1200\text{ mA}$, $P_{out} = 35\text{ W Avg. N-CDMA}$, $f = 880\text{ MHz}$, Single-Carrier N-CDMA, 1.2288 MHz Channel Bandwidth Carrier. ACPR measured in 30 kHz Channel Bandwidth @ $\pm 750\text{ kHz}$ Offset. PAR = 9.8 dB @ 0.01% Probability on CCDF

Power Gain	G_{ps}	20	20.9	23	dB
Drain Efficiency	η_D	29	30.5	—	%
Adjacent Channel Power Ratio	ACPR	—	-46.8	-45	dBc
Input Return Loss	IRL	—	-17	-9	dB

Typical GSM EDGE Performances (In Freescale GSM EDGE Test Fixture, 50 ohm system) $V_{DD} = 28\text{ Vdc}$, $I_{DQ} = 1200\text{ mA}$, $P_{out} = 76\text{ W Avg.}$, 865 MHz < Frequency < 895 MHz

Power Gain	G_{ps}	—	20	—	dB
Drain Efficiency	η_D	—	45	—	%
Error Vector Magnitude	EVM	—	2	—	% rms
Spectral Regrowth at 400 kHz Offset	SR1	—	-66	—	dBc
Spectral Regrowth at 600 kHz Offset	SR2	—	-75	—	dBc

Typical CW Performances (In Freescale GSM Test Fixture, 50 ohm system) $V_{DD} = 28\text{ Vdc}$, $I_{DQ} = 1200\text{ mA}$, $P_{out} = 160\text{ W}$, 921 MHz < Frequency < 960 MHz

Power Gain	G_{ps}	—	20	—	dB
Drain Efficiency	η_D	—	58	—	%
Input Return Loss	IRL	—	-12	—	dB
P_{out} @ 1 dB Compression Point, CW ($f = 940\text{ MHz}$)	P1dB	—	160	—	W

1. Part is internally matched on input.

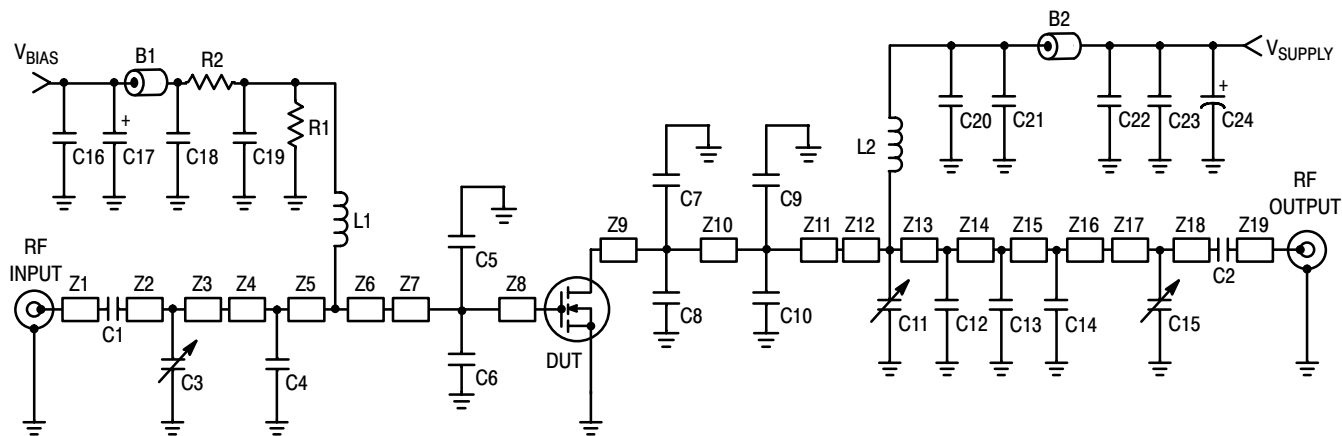

Z1	0.426" x 0.080" Microstrip	Z11	0.066" x 0.630" Microstrip
Z2	0.813" x 0.080" Microstrip	Z12	0.630" x 0.425" x 0.220" Taper
Z3	0.471" x 0.080" Microstrip	Z13	0.120" x 0.220" Microstrip
Z4	0.319" x 0.220" Microstrip	Z14	0.292" x 0.220" Microstrip
Z5	0.171" x 0.220" Microstrip	Z15	0.023" x 0.220" Microstrip
Z6	0.200" x 0.425" x 0.630" Taper	Z16	0.030" x 0.220" Microstrip
Z7	0.742" x 0.630" Microstrip	Z17	0.846" x 0.080" Microstrip
Z8	0.233" x 0.630" Microstrip	Z18	0.440" x 0.080" Microstrip
Z9	0.128" x 0.630" Microstrip	Z19	0.434" x 0.080" Microstrip
Z10	0.134" x 0.630" Microstrip	PCB	Arlon CuClad 250GX-0300-55-22, 0.030", $\epsilon_r = 2.55$

Figure 1. MRF6S9160HR3(SR3) Test Circuit Schematic

Table 5. MRF6S9160HR3(SR3) Test Circuit Component Designations and Values

Part	Description	Part Number	Manufacturer
B1, B2	Ferrite Beads, Small	2743019447	Fair Rite
C1, C2, C19	47 pF Chip Capacitors	ATC100B470JT500XT	ATC
C3, C11	0.8-8.0 pF Variable Capacitors, Gigatrim	27291SL	Johanson
C4	2.7 pF Chip Capacitor	ATC100B2R7JT500XT	ATC
C5, C6	15 pF Chip Capacitors	ATC100B150JT500XT	ATC
C7, C8	12 pF Chip Capacitors	ATC100B120JT500XT	ATC
C9, C10	4.3 pF Chip Capacitors	ATC100B4R3JT500XT	ATC
C12	8.2 pF Chip Capacitor	ATC100B8R2JT500XT	ATC
C13, C14	3.9 pF Chip Capacitors	ATC100B3R9JT500XT	ATC
C15	0.6-4.5 pF Variable Capacitor, Gigatrim	27271SL	Johanson
C16	22 pF Chip Capacitor	ATC100B220JT500XT	ATC
C17	1 μ F, 50 V Tantalum Capacitor	T491C105K0J0AT	Kemite
C18	20K pF Chip Capacitor	CDR35BP203AKYS	Kemite
C20	180 pF Chip Capacitor	ATC100B181JT500XT	ATC
C21, C22, C23	10 μ F, 50 V Chip Capacitors	GRM55DR61H106KA88B	Murata
C24	470 μ F, 63 V Electrolytic Capacitor	EKME630ELL471MK25S	United Chemi-Con
L1, L2	10 nH Inductors	0603HC	Coilcraft
R1	180 Ω , 1/4 W Chip Resistor	CRCW12061800FKEA	Vishay
R2	10 Ω , 1/4 W Chip Resistor	CRCW120610R0FKEA	Vishay

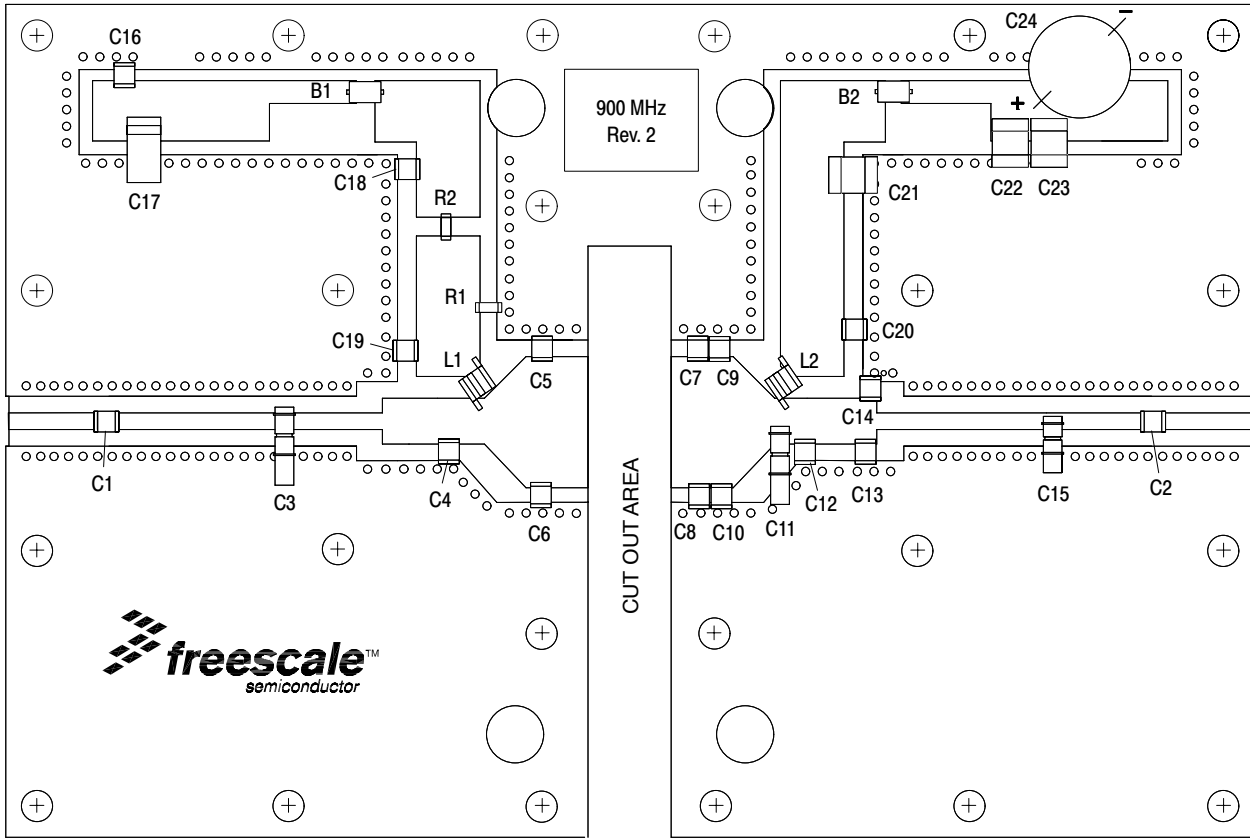

Figure 2. MRF6S9160HR3(SR3) Test Circuit Component Layout

TYPICAL CHARACTERISTICS

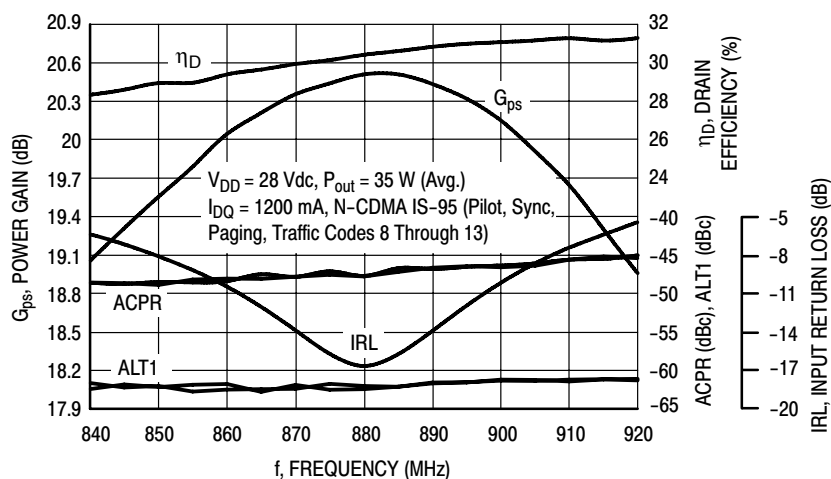

Figure 3. Single-Carrier N-CDMA Broadband Performance @ $P_{out} = 35$ Watts Avg.

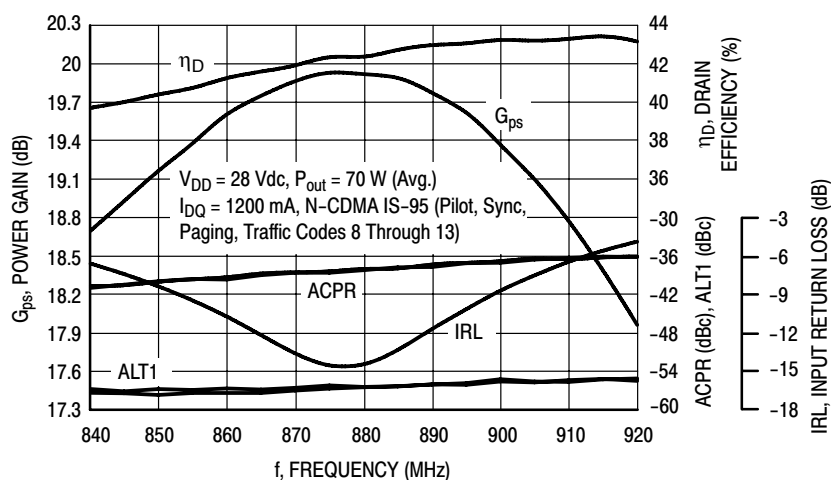

Figure 4. Single-Carrier N-CDMA Broadband Performance @ $P_{out} = 70$ Watts Avg.

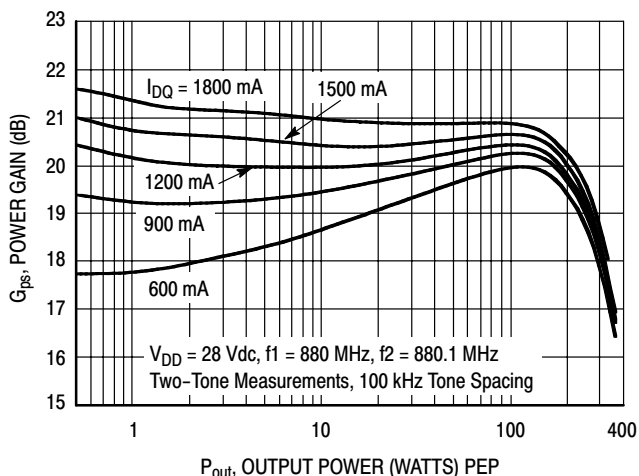

Figure 5. Two-Tone Power Gain versus Output Power

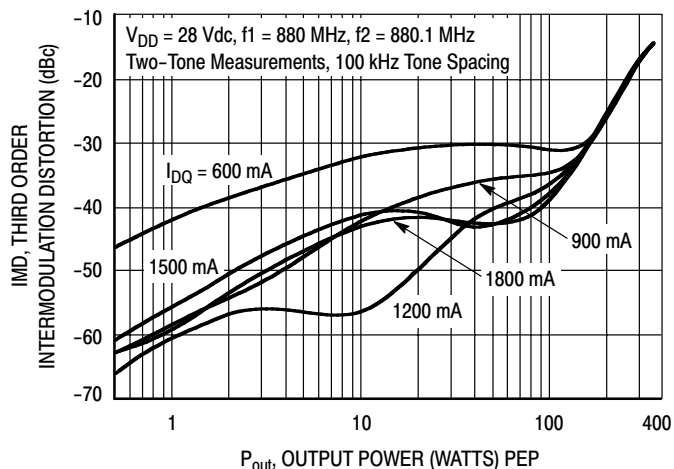

Figure 6. Third Order Intermodulation Distortion versus Output Power

ARCHIVE INFORMATION

ARCHIVE INFORMATION

TYPICAL CHARACTERISTICS

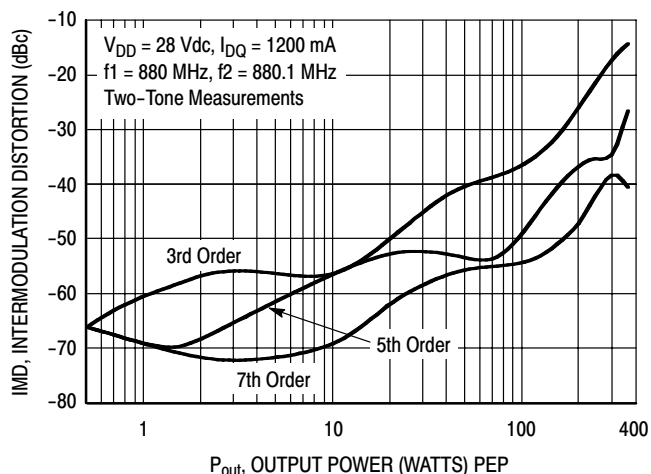

Figure 7. Intermodulation Distortion Products versus Output Power

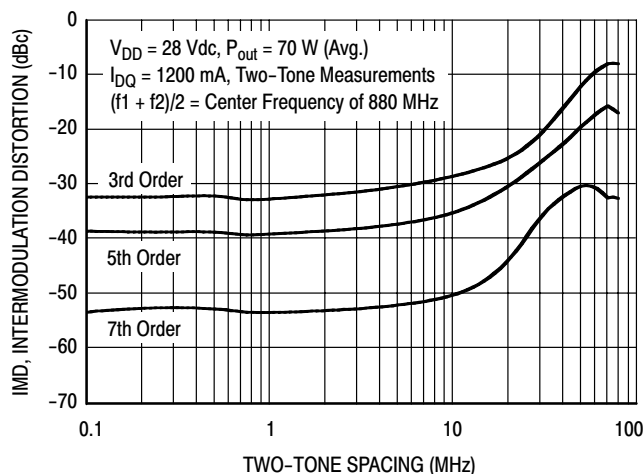

Figure 8. Intermodulation Distortion Products versus Tone Spacing

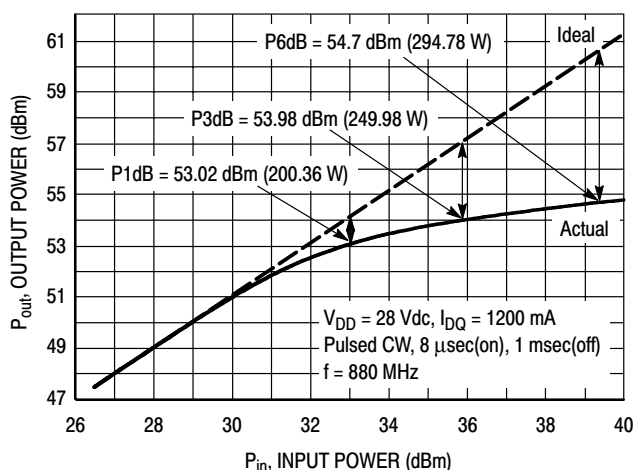

Figure 9. Pulsed CW Output Power versus Input Power

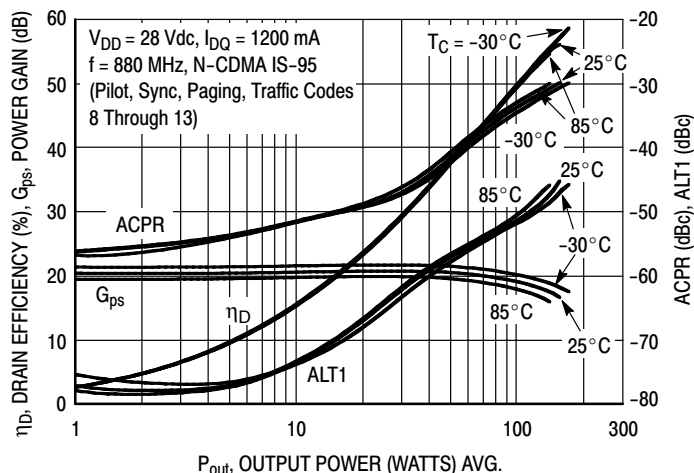

Figure 10. Single-Carrier N-CDMA ACPR, ALT1, Power Gain and Drain Efficiency versus Output Power

ARCHIVE INFORMATION

ARCHIVE INFORMATION

TYPICAL CHARACTERISTICS

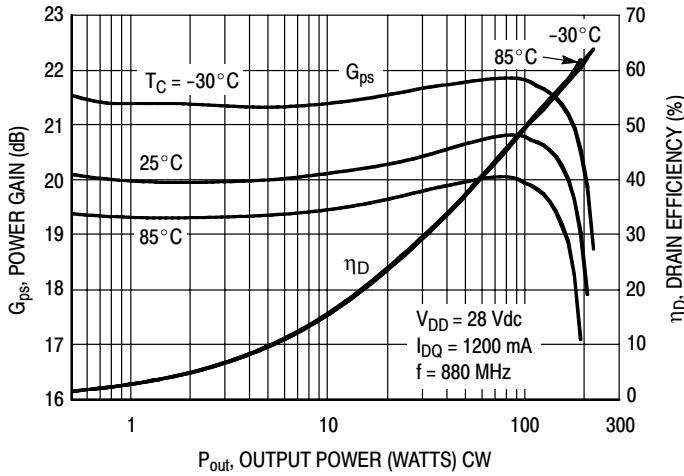

Figure 11. Power Gain and Drain Efficiency versus CW Output Power

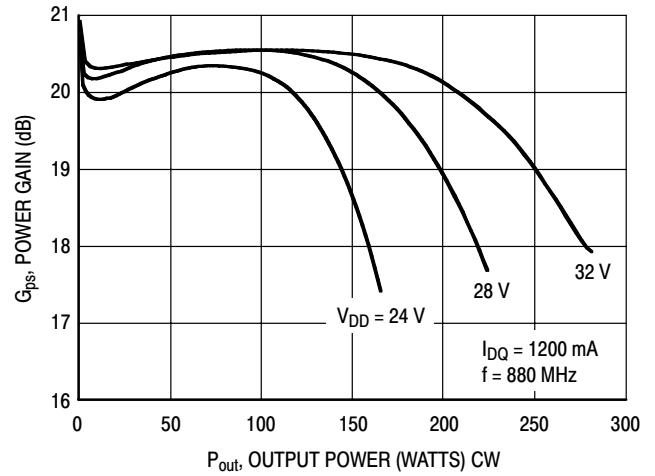
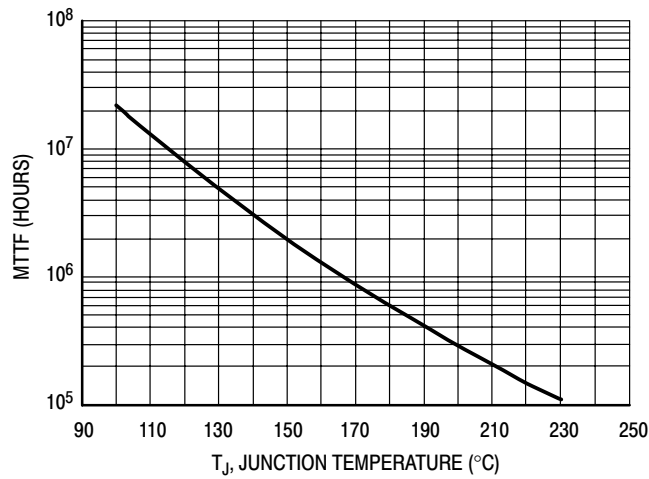

Figure 12. Power Gain versus Output Power



This above graph displays calculated MTTF in hours when the device is operated at $V_{DD} = 28 \text{ Vdc}$, $P_{out} = 35 \text{ W Avg.}$, and $\eta_D = 30.5\%$.

MTTF calculator available at <http://www.freescale.com/rf>. Select Software & Tools/Development Tools/Calculators to access MTTF calculators by product.

Figure 13. MTTF versus Junction Temperature

ARCHIVE INFORMATION

ARCHIVE INFORMATION

N-CDMA TEST SIGNAL

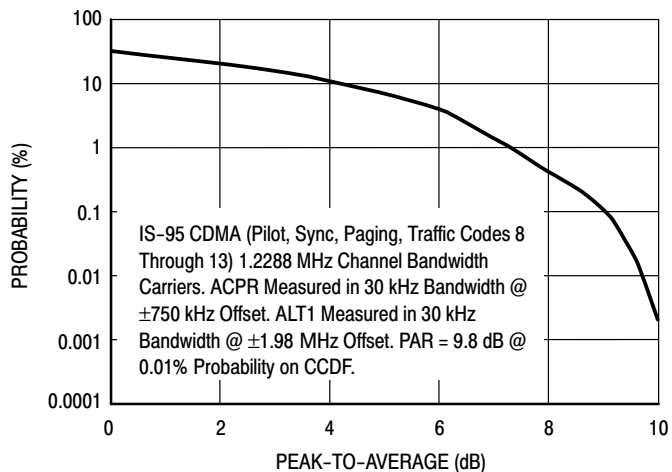

Figure 14. Single-Carrier CCDF N-CDMA

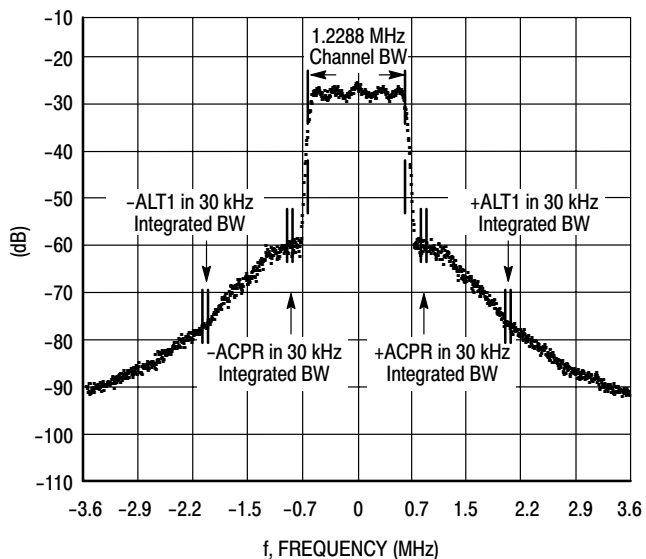
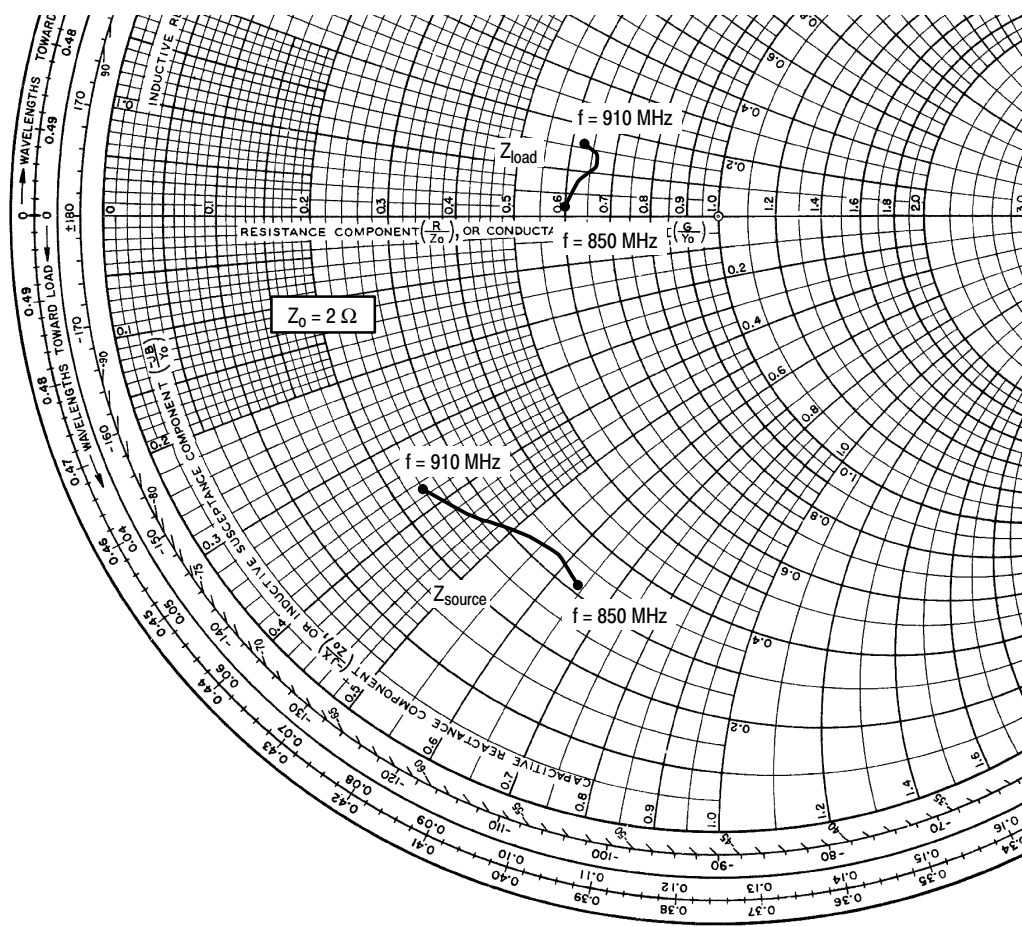

Figure 15. Single-Carrier N-CDMA Spectrum

ARCHIVE INFORMATION

ARCHIVE INFORMATION



$V_{DD} = 28 \text{ Vdc}$, $I_{DQ} = 1200 \text{ mA}$, $P_{out} = 35 \text{ W Avg.}$

f MHz	Z_{source} Ω	Z_{load} Ω
850	$0.61 - j1.27$	$1.20 + j0.03$
865	$0.66 - j1.15$	$1.26 + j0.15$
880	$0.64 - j1.05$	$1.31 + j0.22$
895	$0.55 - j0.90$	$1.32 + j0.28$
910	$0.48 - j0.74$	$1.26 + j0.32$

Z_{source} = Test circuit impedance as measured from gate to ground.

Z_{load} = Test circuit impedance as measured from drain to ground.

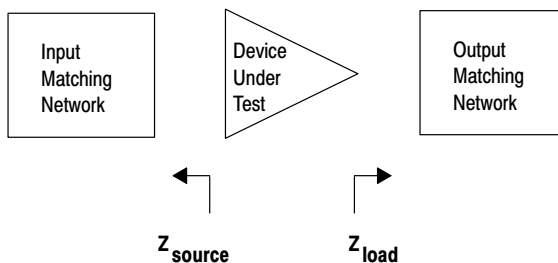
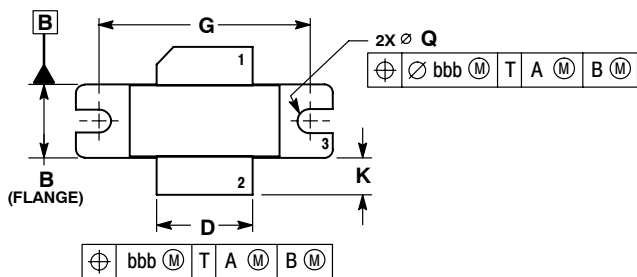

Figure 16. Series Equivalent Source and Load Impedance

PACKAGE DIMENSIONS



- NOTES:
1. DIMENSIONING AND TOLERANCING PER ANSI Y14.5M-1994.
 2. CONTROLLING DIMENSION: INCH.
 3. DELETED
 4. DIMENSION H IS MEASURED 0.030 (0.762) AWAY FROM PACKAGE BODY.

DIM	INCHES		MILLIMETERS	
	MIN	MAX	MIN	MAX
A	1.335	1.345	33.91	34.16
B	0.380	0.390	9.65	9.91
C	0.125	0.170	3.18	4.32
D	0.495	0.505	12.57	12.83
E	0.035	0.045	0.89	1.14
F	0.003	0.006	0.08	0.15
G	1.100 BSC		27.94 BSC	
H	0.057	0.067	1.45	1.70
K	0.170	0.210	4.32	5.33
M	0.774	0.786	19.66	19.96
N	0.772	0.788	19.60	20.00
Q	Ø 0.118	Ø 0.138	Ø 3.00	Ø 3.51
R	0.365	0.375	9.27	9.53
S	0.365	0.375	9.27	9.52
aaa	0.005 REF		0.127 REF	
bbb	0.010 REF		0.254 REF	
ccc	0.015 REF		0.381 REF	

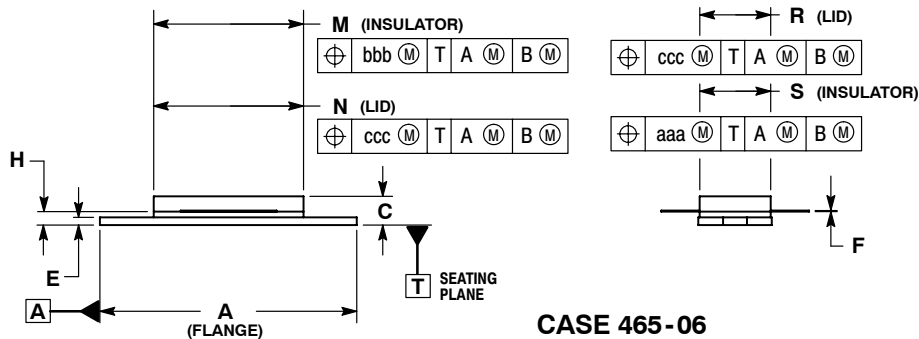

**CASE 465-06
ISSUE G
NI-780
MRF6S9160HR3**

- STYLE 1:
PIN 1. DRAIN
2. GATE
3. SOURCE

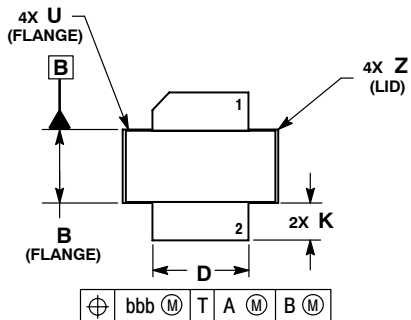

- NOTES:
1. DIMENSIONING AND TOLERANCING PER ANSI Y14.5M-1994.
 2. CONTROLLING DIMENSION: INCH.
 3. DELETED
 4. DIMENSION H IS MEASURED 0.030 (0.762) AWAY FROM PACKAGE BODY.

DIM	INCHES		MILLIMETERS	
	MIN	MAX	MIN	MAX
A	0.805	0.815	20.45	20.70
B	0.380	0.390	9.65	9.91
C	0.125	0.170	3.18	4.32
D	0.495	0.505	12.57	12.83
E	0.035	0.045	0.89	1.14
F	0.003	0.006	0.08	0.15
H	0.057	0.067	1.45	1.70
K	0.170	0.210	4.32	5.33
M	0.774	0.786	19.61	20.02
N	0.772	0.788	19.61	20.02
R	0.365	0.375	9.27	9.53
S	0.365	0.375	9.27	9.52
U	---	0.040	---	1.02
Z	---	0.030	---	0.76
aaa	0.005 REF		0.127 REF	
bbb	0.010 REF		0.254 REF	
ccc	0.015 REF		0.381 REF	

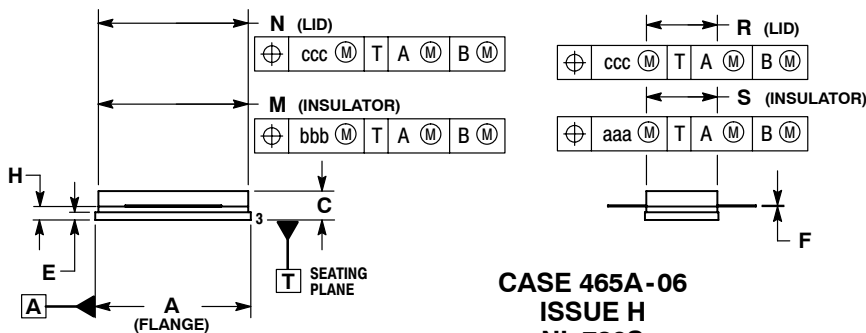

**CASE 465A-06
ISSUE H
NI-780S
MRF6S9160HSR3**

- STYLE 1:
PIN 1. DRAIN
2. GATE
5. SOURCE

ARCHIVE INFORMATION

ARCHIVE INFORMATION

PRODUCT DOCUMENTATION

Refer to the following documents to aid your design process.

Application Notes

- AN1955: Thermal Measurement Methodology of RF Power Amplifiers
- AN1987: Quiescent Current Control for the RF Integrated Circuit Device Family

Engineering Bulletins

- EB212: Using Data Sheet Impedances for RF LDMOS Devices

REVISION HISTORY

The following table summarizes revisions to this document.

Revision	Date	Description
2	Aug. 2008	<ul style="list-style-type: none"> • Listed replacement part and Device Migration notification reference number, p. 1 • Removed Lower Thermal Resistance and Low Gold Plating bullets from Features section as functionality is standard, p. 1 • Removed Total Device Dissipation from Max Ratings table as data was redundant (information already provided in Thermal Characteristics table), p. 1 • Operating Junction Temperature increased from 200°C to 225°C in Maximum Ratings table and related “Continuous use at maximum temperature will affect MTTF” footnote added, p. 1 • Corrected V_{DS} to V_{DD} in the RF test condition voltage callout for $V_{GS(Q)}$, On Characteristics table, p. 2 • Removed Forward Transconductance from On Characteristics table as it no longer provided usable information, p. 2 • Updated PCB information to show more specific material details, Fig. 1, Test Circuit Schematic, p. 3 • Updated Part Numbers in Table 5, Component Designations and Values, to latest RoHS compliant part numbers, p. 3 • Adjusted scale for Fig. 8, Intermodulation Distortion Products versus Tone Spacing, to show wider dynamic range, p. 6 • Removed lower voltage tests from Fig. 12, Power Gain versus Output Power, due to fixed tuned fixture limitations, p. 7 • Replaced Fig. 13, MTTF versus Junction Temperature with updated graph. Removed Amps² and listed operating characteristics and location of MTTF calculator for device, p. 7 • Added Product Documentation and Revision History, p. 11

ARCHIVE INFORMATION

ARCHIVE INFORMATION

How to Reach Us:**Home Page:**

www.freescale.com

Web Support:

<http://www.freescale.com/support>

USA/Europe or Locations Not Listed:

Freescale Semiconductor, Inc.
Technical Information Center, EL516
2100 East Elliot Road
Tempe, Arizona 85284
1-800-521-6274 or +1-480-768-2130
www.freescale.com/support

Europe, Middle East, and Africa:

Freescale Halbleiter Deutschland GmbH
Technical Information Center
Schatzbogen 7
81829 Muenchen, Germany
+44 1296 380 456 (English)
+46 8 52200080 (English)
+49 89 92103 559 (German)
+33 1 69 35 48 48 (French)
www.freescale.com/support

Japan:

Freescale Semiconductor Japan Ltd.
Headquarters
ARCO Tower 15F
1-8-1, Shimo-Meguro, Meguro-ku,
Tokyo 153-0064
Japan
0120 191014 or +81 3 5437 9125
support.japan@freescale.com

Asia/Pacific:

Freescale Semiconductor China Ltd.
Exchange Building 23F
No. 118 Jianguo Road
Chaoyang District
Beijing 100022
China
+86 10 5879 8000
support.asia@freescale.com

For Literature Requests Only:

Freescale Semiconductor Literature Distribution Center
P.O. Box 5405
Denver, Colorado 80217
1-800-441-2447 or +1-303-675-2140
Fax: +1-303-675-2150
LDCForFreescaleSemiconductor@hibbertgroup.com

Information in this document is provided solely to enable system and software implementers to use Freescale Semiconductor products. There are no express or implied copyright licenses granted hereunder to design or fabricate any integrated circuits or integrated circuits based on the information in this document.

Freescale Semiconductor reserves the right to make changes without further notice to any products herein. Freescale Semiconductor makes no warranty, representation or guarantee regarding the suitability of its products for any particular purpose, nor does Freescale Semiconductor assume any liability arising out of the application or use of any product or circuit, and specifically disclaims any and all liability, including without limitation consequential or incidental damages. "Typical" parameters that may be provided in Freescale Semiconductor data sheets and/or specifications can and do vary in different applications and actual performance may vary over time. All operating parameters, including "Typicals", must be validated for each customer application by customer's technical experts. Freescale Semiconductor does not convey any license under its patent rights nor the rights of others. Freescale Semiconductor products are not designed, intended, or authorized for use as components in systems intended for surgical implant into the body, or other applications intended to support or sustain life, or for any other application in which the failure of the Freescale Semiconductor product could create a situation where personal injury or death may occur. Should Buyer purchase or use Freescale Semiconductor products for any such unintended or unauthorized application, Buyer shall indemnify and hold Freescale Semiconductor and its officers, employees, subsidiaries, affiliates, and distributors harmless against all claims, costs, damages, and expenses, and reasonable attorney fees arising out of, directly or indirectly, any claim of personal injury or death associated with such unintended or unauthorized use, even if such claim alleges that Freescale Semiconductor was negligent regarding the design or manufacture of the part.

Freescale™ and the Freescale logo are trademarks of Freescale Semiconductor, Inc. All other product or service names are the property of their respective owners.

© Freescale Semiconductor, Inc. 2005-2006, 2008. All rights reserved.

Looking for pricing, stock, or lifecycle information?

Click below to explore more details on WIN SOURCE:

 [View MRF6S9160HR3 on WIN SOURCE](#)

 [NXP / Nexperia Information](#)

Optimize Your Supply Chain with WIN SOURCE Solutions

-  Global Sourcing Solution
-  Obsolete Management
-  Cost Control Management
-  Shortage Management
-  Alternative Solution
-  Excess Inventory Management