



**THE DATASHEET OF
AVR-M1005C270MTAAB**





Chip Varistors

Countermeasure for surge voltage and static electricity

AVRseries

AVRM0402/AVRL0402	0402 [01005 inch]*
AVRM0603/AVRL0603	0603 [0201 inch]
AVRM1005/AVRL1005	1005 [0402 inch]
AVRM1608/AVRL1608	1608 [0603 inch]
AVRM2012	2012 [0805 inch]

* Dimensions Code JIS[EIA]

REMINDERS FOR USING THESE PRODUCTS

Before using these products, be sure to request the delivery specifications.

SAFETY REMINDERS

Please pay sufficient attention to the warnings for safe designing when using these products.

REMINDERS

- Please observe the following precautions in order to avoid problems with chip varistors such as characteristic degradation and element destruction.
 - Please store these products in an environment with a temperature of 5 to 40°C and humidity level of 20 to 70%RH, and use them within six months.
 - Poor storage conditions may lead to the deterioration of the solderability of the edge electrodes, so please be careful to avoid contact with humidity, dew condensation, dust, toxic gas (hydrogen, hydrogen sulfide, sulfurous acid, chlorine, ammonia, etc.), direct sunlight, and so on.
 - Please do not use products that have been dropped or detached when mounting.
 - Please solder with the reflow soldering method, and not the flow (dip) soldering method.
- Please observe the following precautions to avoid problems with varistors such as characteristic degradation and element destruction, which ultimately lead to the generation of heat and smoke with the elements.
 - Do not use in locations where the temperatures exceed the operating temperature range such as under direct sunlight or near sources of heat.
 - Do not use in locations where there are high levels of humidity such as under direct exposure to weather and areas where steam is released.
 - Do not use in locations such as dusty areas, high-saline environments, places where the atmosphere is contaminated with corrosive gas, etc.
 - Avoid powerful vibrations, impact (such as by dropping), pressure, etc. that may lead to splitting in the products.
 - Do not use with a voltage that exceeds the maximum allowable circuit voltage.**
 - When resin coating (including modular) a varistor, do not use a resin that will cause deterioration of the varistor. Be sure never to use resin that generates hydrogen as palladium is used for the inner electrode.
 - Avoid attachment near combustible materials.
- Please contact our sales offices when considering the use of the products listed on this catalog for applications, whose performance and/or quality require a more stringent level of safety or reliability, or whose failure, malfunction or trouble could cause serious damage to society, person or property ('specific uses' such as automobiles, airplanes, medical instruments, nuclear devices, etc.) as well as when considering the use for applications that exceed the range and conditions of this catalog.
 - Please also contact us when using these products for automotive applications.
- Please note that we are not responsible for any damages or losses incurred resulting from the use of these products that exceeds the range and conditions of this catalog or specific uses.
- Please take appropriate measures such as acquiring protective circuits and devices that meet the uses, applications, and conditions of the instruments and keeping backup circuits.

Chip Varistors

Product compatible with RoHS directive
Compatible with lead-free solders

Countermeasure for surge voltage and static electricity

Overview of the AVR Series

CHARACTERISTICS OF CHIP VARISTOR

Varistors are voltage dependent nonlinear resistive elements with a resistance that decreases rapidly when the voltage is over the constant value.

Varistor is equivalent with Zener diode of two series connection. Therefore, do not have polarity.

CURRENT vs. VOLTAGE CHARACTERISTICS

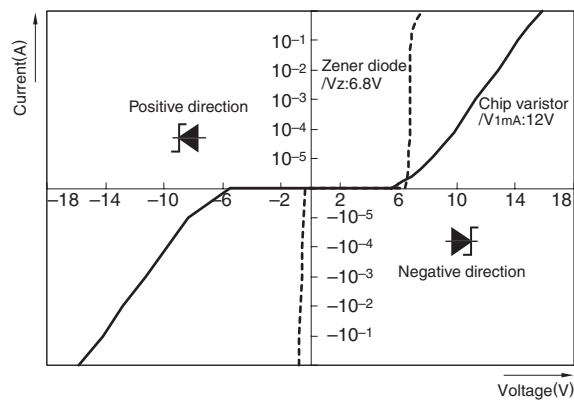

EQUIVALENT CIRCUIT



THE EFFECT OF THE VARISTOR

Without Varistor

A malfunction and failure of electronic equipment



With Varistor

Suppress abnormal voltage by inserting varistor in a circuit



○ RoHS Directive Compliant Product: See the following for more details related to RoHS Directive compliant products. <http://product.tdk.com/en/environment/rohs/>

• All specifications are subject to change without notice.

Overview of the AVR Series

MEASURING CIRCUIT

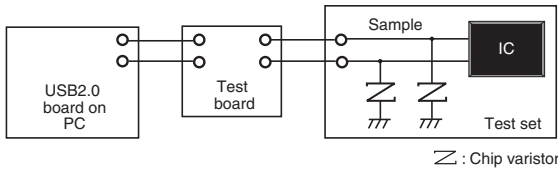

Without Varistor



With Varistor

AVRL101A3R3FTA (3.3pF)



AVRL101A6R8GTA (6.8pF)

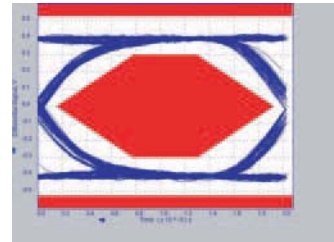

MERITS OF REPLACEMENT FROM ZENER DIODE

(1) Reduction in the Number of Parts

Production examples

Zener diode+capacitor

Chip varistor



Example of replacement at audio terminal

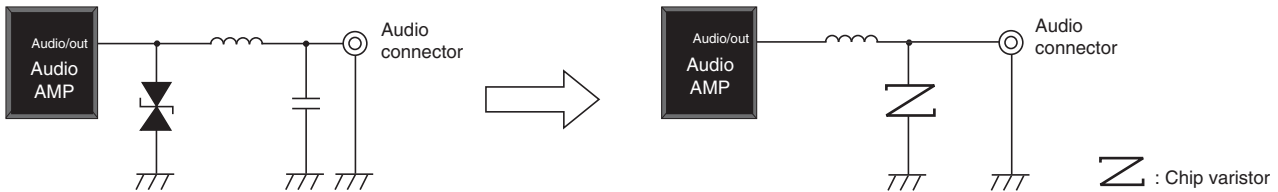

(2) Improved Electrostatic Absorption Capability

Compare data of chip varistor and zener diode about IC protection

ESD measurements of CMOS-ICs with AVR-type varistors and zener diodes

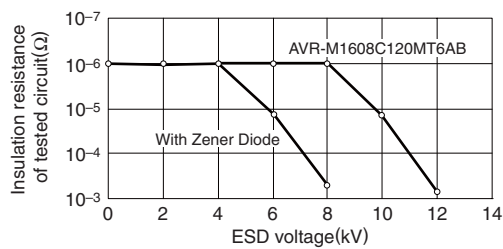

CMOS: D74HC04C

ESD generator : Noise Laboratory Co.,Ltd., ESS -630A

200pF-0Ω method model equipment

Contact type discharge

ESD applied point: Vcc-ground

• All specifications are subject to change without notice.

Overview of the AVR Series

FEATURES

- No polarity, due to symmetrical current-voltage characteristics. Equivalent to anode common type Zener diode.
- Excellent electrostatic absorption capability. Response is as good or better than Zener diode. Keeps symmetrical current-voltage characteristics even after electrostatic absorption.
- Adopted the inner electrodes lamination structure.
 - Wide range of varistor voltages are available in series (6.8 to 90V).
 - Low capacitance items are available in series (from 1.1pF).
 - World's smallest 0402-, 0603-, 1005-, 1608-, 2012-chip size are available in series.
- Excellent mount reliability. Good for Pb-free soldering. Adopted (Ni/Sn) electroplating. Achieved good solderability and solder heat resistance.
- Can replace a Zener diode + capacitor combination. Reduced footprint and total mounting cost.

APPLICATION

- Electrostatic absorption
- Pulse noise absorption

APPLICATION EXAMPLES

Consumer product	Application
Mobile phone	Data terminal
Digital video camera	LCD panel
Digital camera	Touch panel
PDA	Button and switch unit
Note PC	Battery terminal
DVD-ROM, CD-ROM	Audio-Video input-output terminal
CD/MD/MP3 player	Microphone/receiver unit
Game machine	Controller unit
	CAN-BUS
	ECU
In-car equipment	Connector
	Air conditioner panel
	Car audio
	Car navigation

SMART PHONE

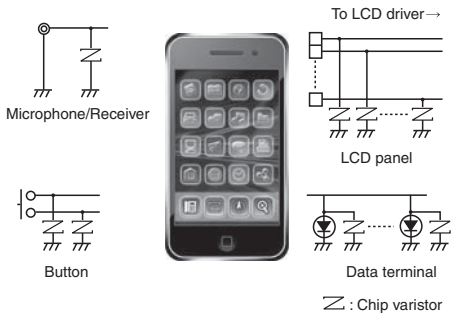

USB2.0

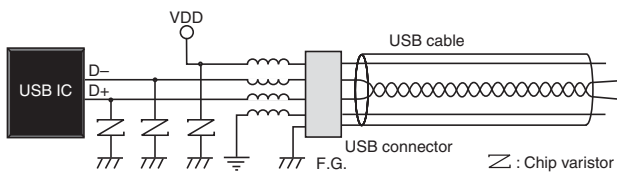

AUDIO, VIDEO

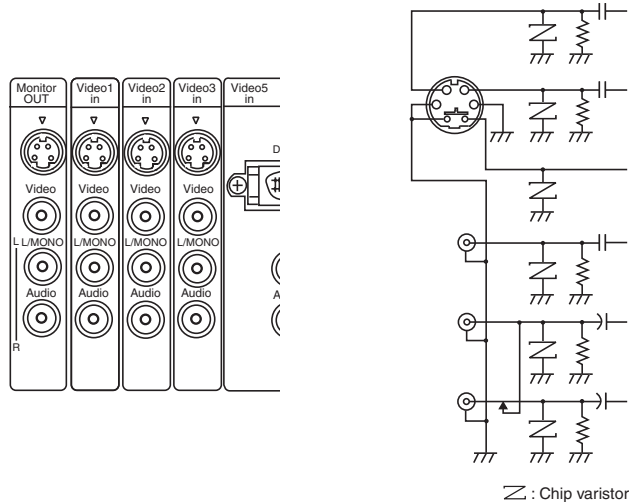

• All specifications are subject to change without notice.

Overview of the AVR Series

PART NUMBER CONSTRUCTION

AVRM	1005	C	6R8	N	T	101	N			
Series name	LxW Dimensions (mm)	Structure code	Varistor voltage (V)		Varistor voltage tolerance (%)		Packaging style	Capacitance or TDK internal code	Capacitance tolerance* (%)	
	0402	0.4×0.2	6R8	6.8	K	±10	T	Taping	M	±20
	0603	0.6×0.3	270	27	M	±20	B	Bulk	N	±30
	1005	1.0×0.5			N	±30				
	1608	1.6×0.8								
	2012	2.0×1.2								

* When the capacitance is not included in the part number, the capacitance tolerance is also not described.

AVRL	10	1A	3R3	F	T	A				
Series name	LxW Dimensions (mm)	Maximum continuous voltage (Vdc)		Capacitance (pF)		Capacitance tolerance (pF)	Packaging style	Varistor voltage or TDK internal code		
	04	0.4×0.2	1A	10	1R1	1.1	D	±0.5	T	Taping
	06	0.6×0.3	1C	16	2R2	2.2	F	±1		
	10	1.0×0.5	1E	25	3R3	3.3	G	±2		
	16	1.6×0.8			6R8	6.8	N	±0.3		

OPERATING TEMPERATURE RANGE, PACKAGE QUANTITY, PRODUCT WEIGHT

Type	Temperature range		Package quantity (pieces/reel)	Individual weight (mg) typ.
	Operating temperature*	Storage temperature**		
	(°C)	(°C)		
AVRM0402	-40 to +85	-40 to +85	20,000	0.1
AVRL0402	-40 to +85	-40 to +85	20,000	0.1
AVRM0603	-40 to +85	-40 to +85	15,000	0.2
AVRL0603	-40 to +85	-40 to +85	15,000	0.2
AVRM1005	-40 to +125	-40 to +125	10,000	1.2
AVRL1005	-40 to +85	-40 to +85	10,000	1.2
AVRM1608	-40 to +125	-40 to +125	4,000	5
AVRL1608	-40 to +85	-40 to +85	4,000	5
AVRM2012	-40 to +125	-40 to +125	2,000	12

* Operating temperature range includes self-temperature rise.

** The Storage temperature range is for after the circuit board is mounted.

OPERATIONAL VOLTAGE RANGES

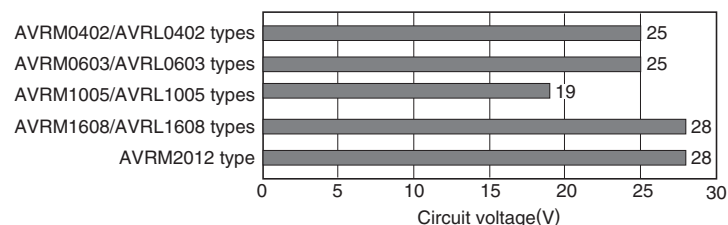

• All specifications are subject to change without notice.

Overview of the AVR Series

■ TERMINOLOGY

Item	Unit	Terminology
Varistor voltage (Breakdown voltage)	V _{1mA} (V)	Voltage measured across the varistor when DC1mA is applied.
Maximum continuous voltage (Rated voltage)	V _{dc} (V)	Maximum DC voltage that can be applied continuously. Varistor leakage current: 50μA max. (Within the range of maximum allowable circuit voltage)
Clamping voltage	V _{cl} (V)	Voltage appearing across the varistor when a pulse current (8/20μs ^{*1}) of specified peak value is applied.
Maximum energy	E (Joule)	Maximum energy that can be absorbed without deteriorating varistor characteristics when an impulse current (10/1000μs ^{*2}) is applied once.
Maximum peak current	I _p (A)	Maximum current that can be withstood without deteriorating varistor characteristics when an impulse current (8/20μs ^{*1}) is applied once.
Capacitance	C (pF)	Capacitance measured at 1kHz (or 1MHz) of oscillator frequency and 1V _{rms} of oscillator voltage.
Insulation resistance	R _{dc} (MΩ)	Insulation resistance appearing across the varistor when specified voltage is applied.

*1 8/20μs test waveform



*2 10/1000μs test waveform



Overview of the AVR Series

RECOMMENDED REFLOW PROFILE



Preheating			Soldering		Peak	
Temp.	Temp.	Time	Temp.	Time	Temp.	Time
T1	T2	t1	T3	t2	T4	t3
150°C	180°C	120s max.	230°C	40s max.	260°C max.	5s

• All specifications are subject to change without notice.

AVR series

AVRM0402/AVRL0402 Types



■ SHAPE & DIMENSIONS



Dimensions in mm

■ INTERNAL STRUCTURE



■ RECOMMENDED LAND PATTERN



■ CIRCUITS DIAGRAM



• All specifications are subject to change without notice.

AVR series **AVRM0402/AVRL0402** Types

■ ELECTRICAL CHARACTERISTICS

□ CHARACTERISTICS SPECIFICATION TABLE

AVRM0402

Part No.	Varistor voltage (Breakdown voltage)	Maximum continuous voltage (Rated voltage)	Clamping voltage	Maximum energy	Maximum peak current	Capacitance
	V _{1mA} (V) [DC1mA]	V _{dc} (V) max.	V _{cl} (V) [8/20μs]	E(Joule) [10/1000μs] max.	I _p (A) [8/20μs] max.	C(pF) [1kHz, 1Vrms] typ.
AVRM0402C6R8NT101N	6.8 (4.76 to 8.84)	3.5	15[1A]	0.01	4	100 (70 to 130)
AVRM0402C120MT330N	12 (9.6 to 14.4)	5.5	20[1A]	0.005	1	33 (23.1 to 43.9)

AVRL0402

Part No.	Varistor voltage	Maximum continuous voltage (Rated voltage)	Capacitance	Insulation resistance
	V _{1mA} (V) [DC1mA] typ.	V _{dc} (V) max.	C(pF) [1MHz, 1Vrms]	R _{dc} (MΩ) [3Vrms] min.
AVRL041E1R1NTA	39	25	1.1[0.8 to 1.4]	10

AVR series **AVRM0402/AVRL0402** Types

■ ELECTRICAL CHARACTERISTICS

□ CURRENT vs. VOLTAGE CHARACTERISTICS

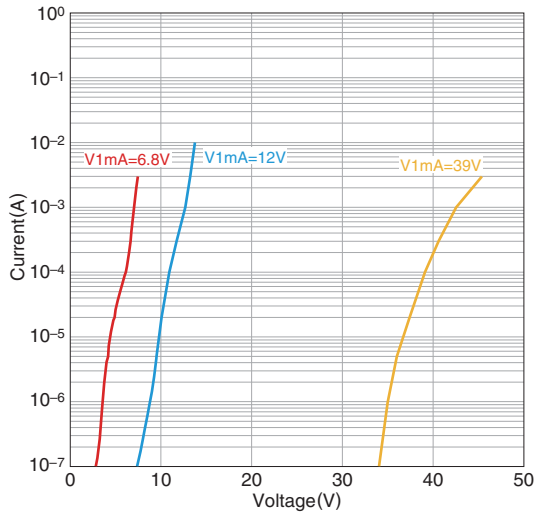

□ IMPEDANCE vs. FREQUENCY CHARACTERISTICS

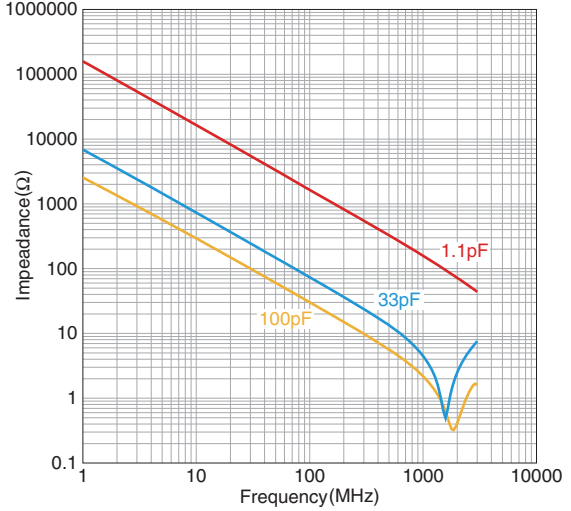

□ TRANSMISSION CHARACTERISTICS

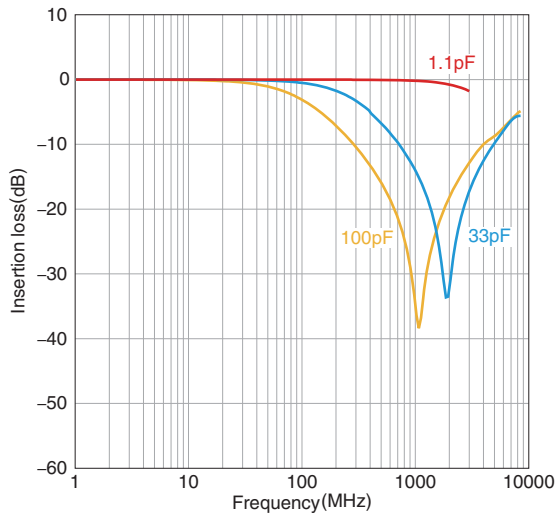

□ CAPACITANCE vs. FREQUENCY CHARACTERISTICS



• All specifications are subject to change without notice.

AVR series

AVRM0603/AVRL0603 Types



■ SHAPE & DIMENSIONS



Dimensions in mm

■ INTERNAL STRUCTURE



■ RECOMMENDED LAND PATTERN

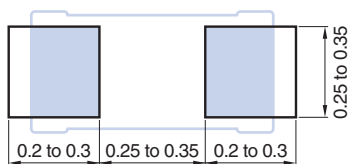

■ CIRCUITS DIAGRAM



• All specifications are subject to change without notice.

AVR series AVR0603/AVRL0603 Types

■ ELECTRICAL CHARACTERISTICS

□ CHARACTERISTICS SPECIFICATION TABLE

AVRM0603

Part No.	Varistor voltage (Breakdown voltage)	Maximum continuous voltage (Rated voltage)	Clamping voltage	Maximum energy	Maximum peak current	Capacitance
	V _{1mA} (V) [DC1mA]	V _{dc} (V) max.	V _{cl} (V) [8/20μs]	E(Joule) [10/1000μs] max.	I _p (A) [8/20μs] max.	C(pF) [1kHz, 1V _{rms}] typ.
AVRM0603C6R8NT331N	6.8 (4.76 to 8.84)	3.5	14[1A]	0.02	16	330 (231 to 429)
AVRM0603C6R8NT101N	6.8 (4.76 to 8.84)	3.5	14[1A]	0.01	10	100 (70 to 130)
AVRM0603C080MT101N	8 (6.4 to 9.6)	5.5	17[1A]	0.01	4	100 (70 to 130)
AVRM0603C120MT101N	12.8 (10 to 15.6)	5.5	20[1A]	0.01	5	100 (70 to 130)
AVR-M0603C120MTAAB	12 (9.6 to 14.4)	7.5	23[1A]	0.01	1	33
AVRM0603C120MT150N	12.8 (10 to 15.6)	5.5	35[1A]	0.003	1	15 (10.5 to 19.5)
AVRM0603C200MT150N	20 (16.0 to 24.0)	12	40[1A]	0.01	1	15 (10.5 to 19.5) [1MHz]

AVRL0603

Part No.	Varistor voltage	Maximum continuous voltage (Rated voltage)	Capacitance	Insulation resistance
	V _{1mA} (V) [DC1mA] typ.	V _{dc} (V) max.	C(pF) [1MHz, 1V _{rms}]	R _{dc} (MΩ) [3V _{rms}] min.
AVRL061E1R1NTA	39	25	1.1[0.8 to 1.4]	10

AVR series AVRM0603/AVRL0603 Types

ELECTRICAL CHARACTERISTICS

CURRENT vs. VOLTAGE CHARACTERISTICS

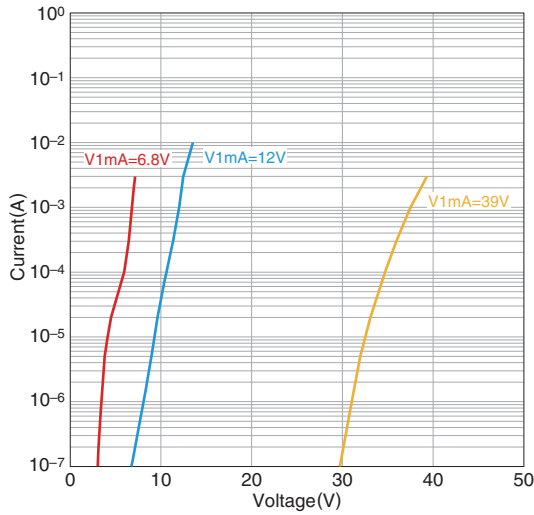

IMPEDANCE vs. FREQUENCY CHARACTERISTICS

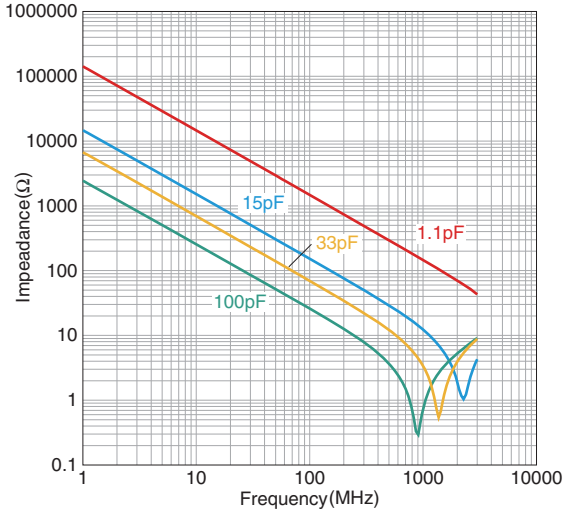

TRANSMISSION CHARACTERISTICS

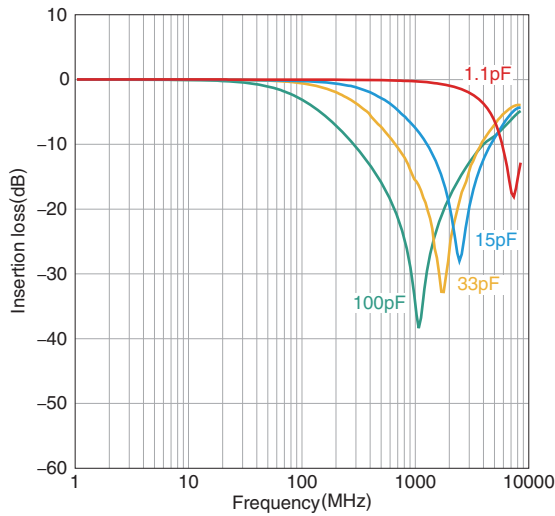

CAPACITANCE vs. FREQUENCY CHARACTERISTICS



• All specifications are subject to change without notice.

AVR series

AVRM1005/AVRL1005 Types



■ SHAPE & DIMENSIONS

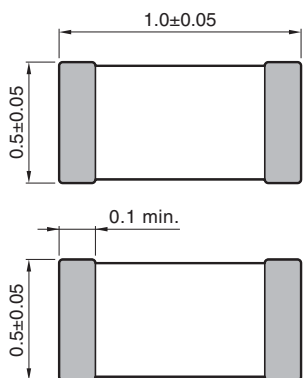

Dimensions in mm

■ INTERNAL STRUCTURE



■ RECOMMENDED LAND PATTERN



■ CIRCUITS DIAGRAM



• All specifications are subject to change without notice.

AVR series AVR_M1005/AVR_L1005 Types

■ ELECTRICAL CHARACTERISTICS

□ CHARACTERISTICS SPECIFICATION TABLE

AVR_M1005

Part No.	Varistor voltage (Breakdown voltage)	Maximum continuous voltage (Rated voltage)	Clamping voltage	Maximum energy	Maximum peak current	Capacitance
	V _{1mA} (V) [DC1mA]	V _{dc} (V) max.	V _{cl} (V) [8/20μs]	E(Joule) [10/1000μs] max.	I _p (A) [8/20μs] max.	C(pF) [1kHz, 1Vrms] typ.
AVRM1005C6R8NT331N	6.8 (4.76 to 8.84)	3.5	15[1A]	0.008	24	330 (231 to 429)
AVRM1005C6R8NT101N	6.8 (4.76 to 8.84)	3.5	14[1A]	0.02	10	100 (70 to 130)
AVR-M1005C080MTAAB	8 (6.4 to 9.6)	5.5	14[1A]	0.04	25	650
AVR-M1005C080MTADB	8 (6.4 to 9.6)	5.5	14[1A]	0.04	25	480
AVR-M1005C080MTABB	8 (6.4 to 9.6)	5.5	15[1A]	0.02	3	100
AVR-M1005C080MTACB	8 (6.4 to 9.6)	5.5	19[1A]	0.01	1	33
AVR-M1005C120MTACC	12 (9.6 to 14.4)	7.5	21[1A]	0.01	24	460 [1MHz]
AVR-M1005C120MTAAB	12 (9.6 to 14.4)	7.5	20[1A]	0.05	10	130
AVR-M1005C180MTAAB	18 (14.4 to 21.6)	11	30[1A]	0.06	16	120 [1MHz]
AVRM1005C270KT101N	27 (24 to 30)	19	44[1A]	0.06	4	100 (70 to 130)
AVR-M1005C270MTAAB	27 (21.6 to 32.4)	15	47[1A]	0.06	4	40
AVR-M1005C270MTABB	27 (21.6 to 32.4)	15	49[1A]	0.05	1	15

AVR_L1005

Part No.	Varistor voltage	Maximum continuous voltage (Rated voltage)	Capacitance	Insulation resistance
	V _{1mA} (V) [DC1mA] typ.	V _{dc} (V) max.	C(pF) [1MHz, 1Vrms]	R _{dc} (MΩ) [3Vrms] min.
AVRL101A1R1NTA	90	10	1.1[0.8 to 1.4]	10
AVRL101A1R1NTB	39	10	1.1[0.8 to 1.4]	10
AVRL101C2R2DTA	90	16	2.2[1.7 to 2.7]	10
AVRL101A3R3FTA	27	10	3.3[2.3 to 4.3]	10
AVRL101A6R8GTA	27	10	6.8[4.8 to 8.8]	10

AVR series AVRM1005/AVRL1005 Types

ELECTRICAL CHARACTERISTICS

CURRENT vs. VOLTAGE CHARACTERISTICS

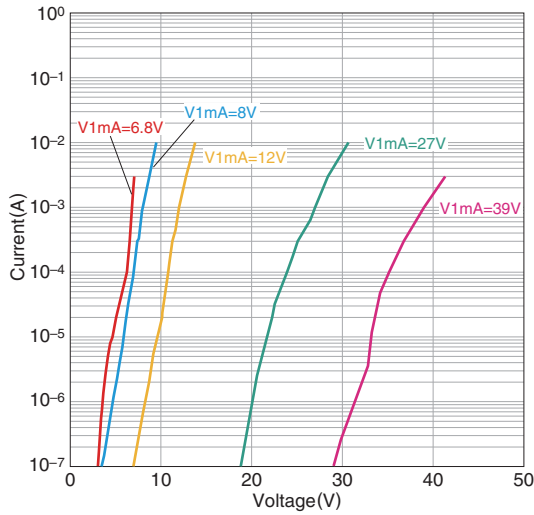

IMPEDANCE vs. FREQUENCY CHARACTERISTICS



TRANSMISSION CHARACTERISTICS

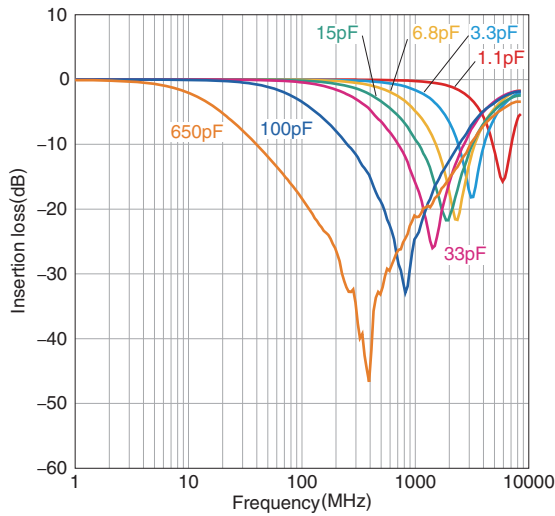

CAPACITANCE vs. FREQUENCY CHARACTERISTICS



• All specifications are subject to change without notice.

AVR series

AVRM1608/AVRL1608 Types



■ SHAPE & DIMENSIONS

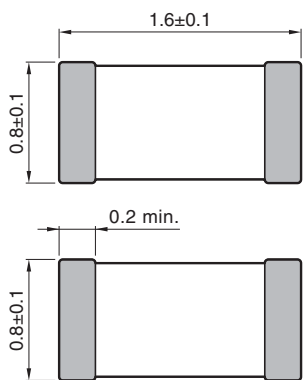

Dimensions in mm

■ INTERNAL STRUCTURE



■ RECOMMENDED LAND PATTERN



■ CIRCUITS DIAGRAM



• All specifications are subject to change without notice.

AVR series AVR1608/AVRL1608 Types

ELECTRICAL CHARACTERISTICS

CHARACTERISTICS SPECIFICATION TABLE

AVRM1608

Part No.	Varistor voltage (Breakdown voltage)	Maximum continuous voltage (Rated voltage)	Clamping voltage	Maximum energy	Maximum peak current	Capacitance
	V _{1mA} (V) [DC1mA]	V _{dc} (V) max.	V _{cl} (V) [8/20μs]	E(Joule) [10/1000μs] max.	I _p (A) [8/20μs] max.	C(pF) [1kHz, 1Vrms] typ.
AVR-M1608C080MTAAB	8 (6.4 to 9.6)	5.5	15[2A]	0.09	30	650
AVR-M1608C120MT6AB	12 (9.6 to 14.4)	7.5	20[2A]	0.09	50	1050
AVR-M1608C120MT2AB	12 (9.6 to 14.4)	7.5	20[2A]	0.06	15	400
AVR-M1608C180MT6AB	18 (14.4 to 21.6)	11	30[2A]	0.1	30	600
AVR-M1608C220KT6AB	22 (19.8 to 24.2)	16	34[2A]	0.1	30	560
AVR-M1608C220KT2AB	22 (19.8 to 24.2)	16	37[2A]	0.03	10	210
AVR-M1608C270KT6AB	27 (24 to 30)	19	42[2A]	0.1	48	430
AVR-M1608C270KT2AB	27 (24 to 30)	19	42[2A]	0.1	20	160
AVR-M1608C270KTACB	27 (24 to 30)	19	54[2A]	0.05	10	60
AVRM1608C270KT800M	27 (24 to 30)	19	53[2A]	0.02	28	80 (64 to 96)
AVR-M1608C270MTAAB	27 (21.6 to 32.4)	17	52[2A]	0.05	2	30
AVR-M1608C270MTABB	27 (21.6 to 32.4)	17	52[2A]	0.05	2	15
AVRM1608C390KT271N	39 (35 to 43)	28	69[2A]	0.1	78	270 (189 to 351)

AVRL1608

Part No.	Varistor voltage	Maximum continuous voltage (Rated voltage)	Capacitance	Insulation resistance
	V _{1mA} (V) [DC1mA] typ.	V _{dc} (V) max.	C(pF) [1MHz, 1Vrms]	R _{dc} (MΩ) [3Vrms] min.
AVRL161A1R1NTA	90	10	1.1[0.8 to 1.4]	10
AVRL161A1R1NTB	39	10	1.1[0.8 to 1.4]	10
AVRL161A3R3FTA	27	10	3.3[2.3 to 4.3]	10
AVRL161A6R8GTA	27	10	6.8[4.8 to 8.8]	10

AVR series AVR1608/AVRL1608 Types

ELECTRICAL CHARACTERISTICS

CURRENT vs. VOLTAGE CHARACTERISTICS

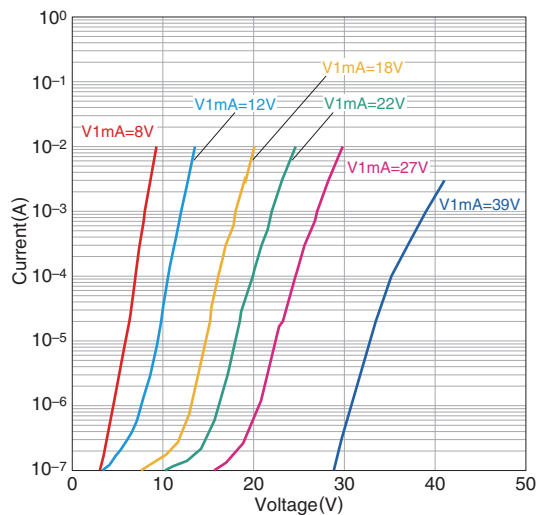

IMPEDANCE vs. FREQUENCY CHARACTERISTICS

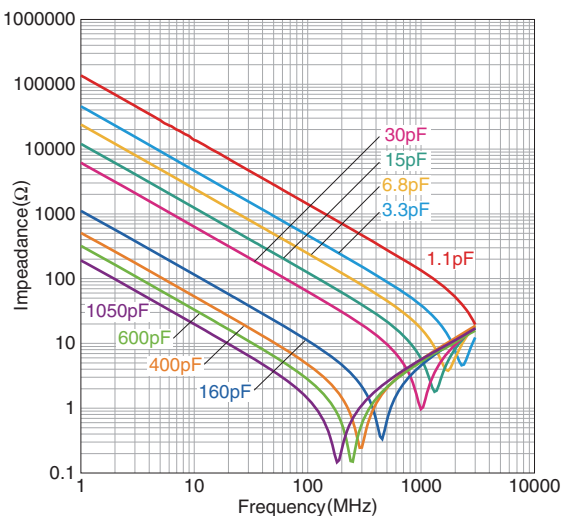

TRANSMISSION CHARACTERISTICS

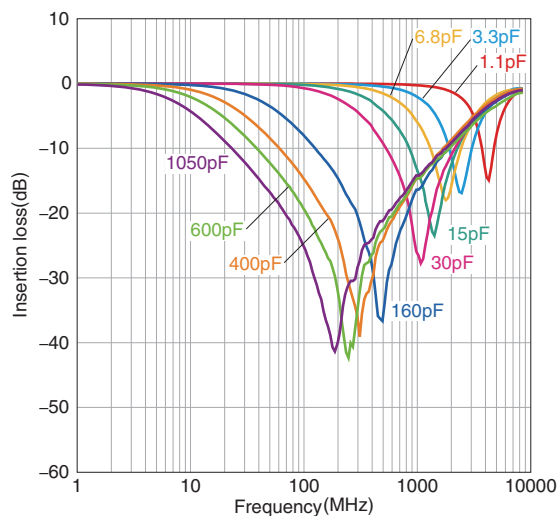

CAPACITANCE vs. FREQUENCY CHARACTERISTICS

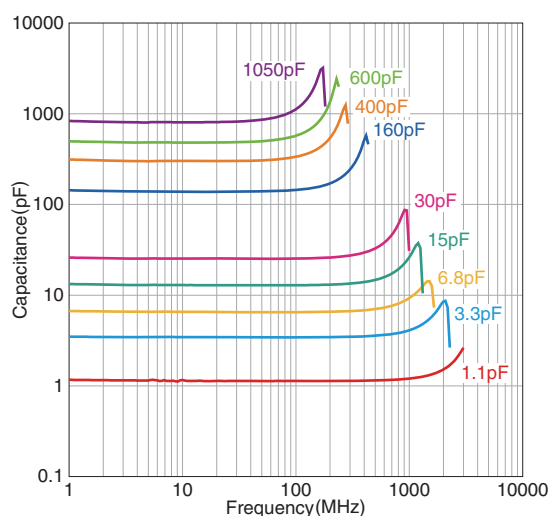

• All specifications are subject to change without notice.

AVR series

AVRM2012 Type



SHAPE & DIMENSIONS



Dimensions in mm

INTERNAL STRUCTURE



RECOMMENDED LAND PATTERN



CIRCUITS DIAGRAM



• All specifications are subject to change without notice.

AVR series **AVRM2012 Type**

■ ELECTRICAL CHARACTERISTICS

□ CHARACTERISTICS SPECIFICATION TABLE

Part No.	Varistor voltage (Breakdown voltage)		Maximum continuous voltage (Rated voltage)	Clamping voltage	Maximum energy	Maximum peak current	Capacitance
	$V_{1mA}(V)$ [DC1mA]	(9.6 to 14.4)	$V_{dc}(V)$ max.	$V_{cl}(V)$ [8/20 μ s]	E(Joule) [10/1000 μ s] max.	$I_p(A)$ [8/20 μ s] max.	C(pF) [1kHz, 1Vrms] typ.
AVR-M2012C120MT6AB	12	(9.6 to 14.4)	7.5	20[5A]	0.2	60	1000
AVR-M2012C220KT6AB	22	(19.8 to 24.2)	16	38[5A]	0.3	100	800
AVR-M2012C390KT6AB	39	(35 to 43)	28	62[5A]	0.3	100	430

AVR series **AVRM2012 Type**

■ ELECTRICAL CHARACTERISTICS

□ CURRENT vs. VOLTAGE CHARACTERISTICS

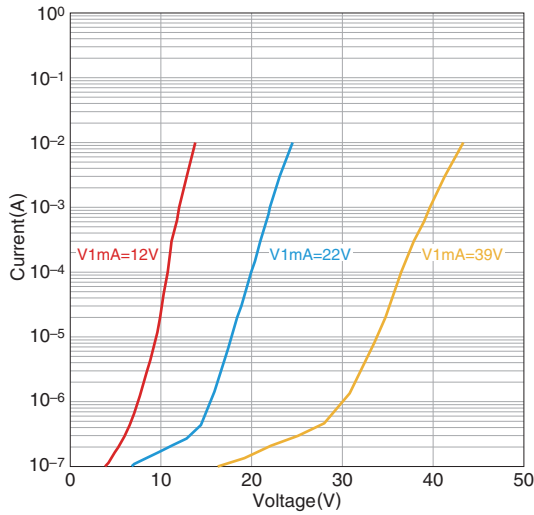

□ IMPEDANCE vs. FREQUENCY CHARACTERISTICS

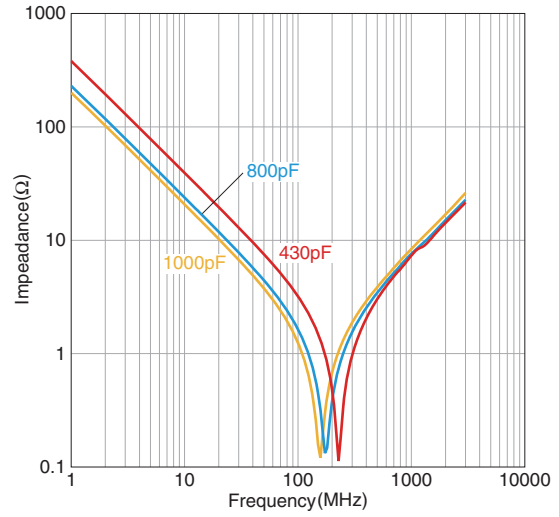

□ TRANSMISSION CHARACTERISTICS

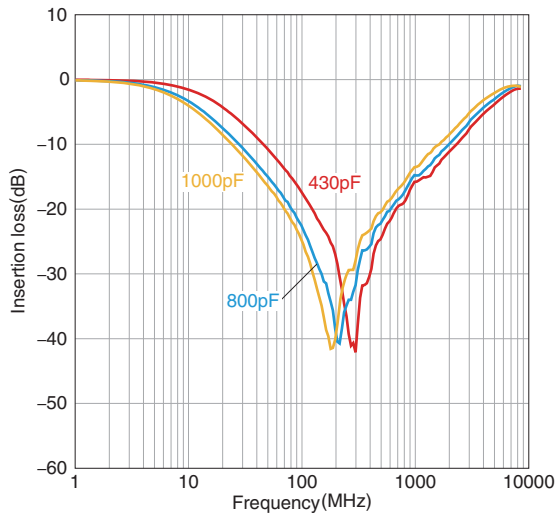

□ CAPACITANCE vs. FREQUENCY CHARACTERISTICS

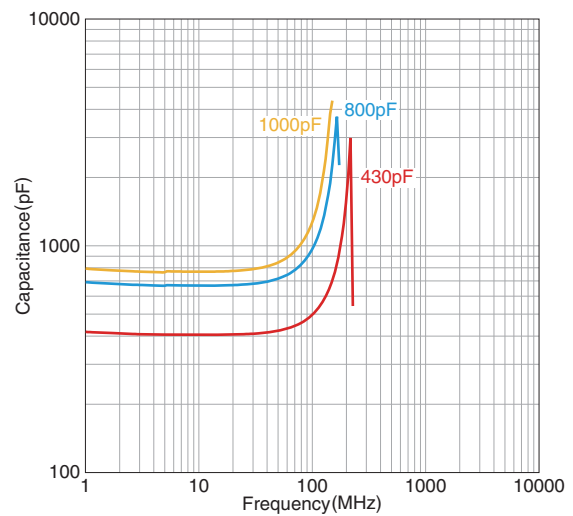

• All specifications are subject to change without notice.

AVR series

Electrostatic discharge tests

ELECTROSTATIC DISCHARGE TESTS (EXAMPLE)

AVR-M1005C080MTAAB



AVRL101A3R3FTA



AVR-M1608C080MTAAB

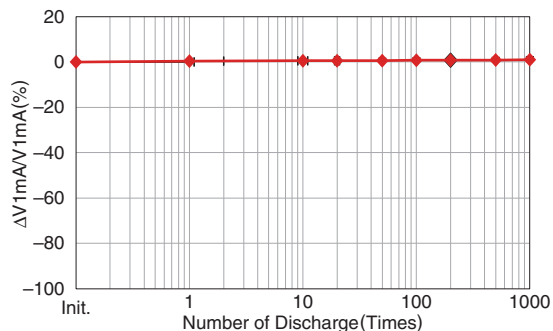

AVRL161A3R3FTA

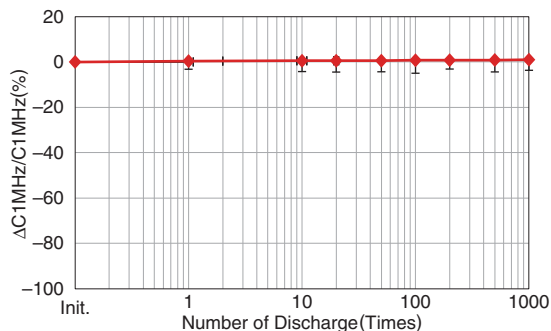

○ Test conditions
 150pF, 330Ω contact discharge
 Charged voltage /8kV, 0.1s interval

○ Measurement equipment



• All specifications are subject to change without notice.

AVR series

Electrostatic absorption characteristics

DISCHARGE CURRENT WAVEFORM

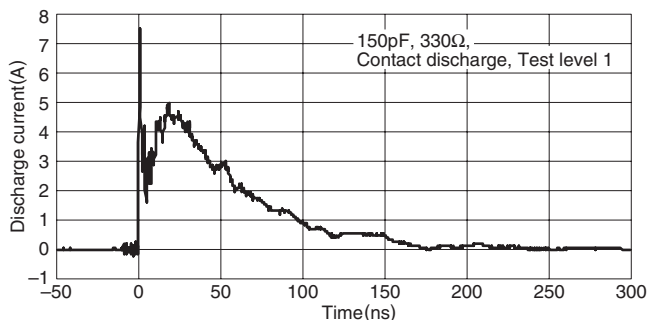

DISCHARGE VOLTAGE WAVEFORM (EXAMPLE)

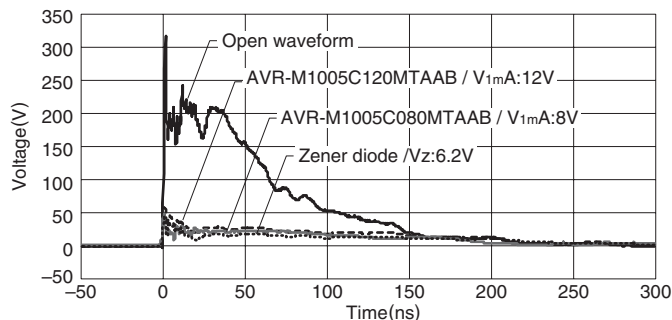

ESD ABSORPTION CHARACTERISTICS COMPARISON OF VARIOUS ELEMENTS (EXAMPLE)



WAVEFORM PARAMETERS [IEC61000-4-2]

Test level	ESD Charge voltage (kV)	First peak current of discharge (A)	Rise time (ns)
1	2	7.5	0.7 to 1.0
2	4	15	0.7 to 1.0
3	6	22.5	0.7 to 1.0
4	8	30	0.7 to 1.0

MEASUREMENT EQUIPMENT



• All specifications are subject to change without notice.

AVR series

Packaging Style

REEL DIMENSIONS

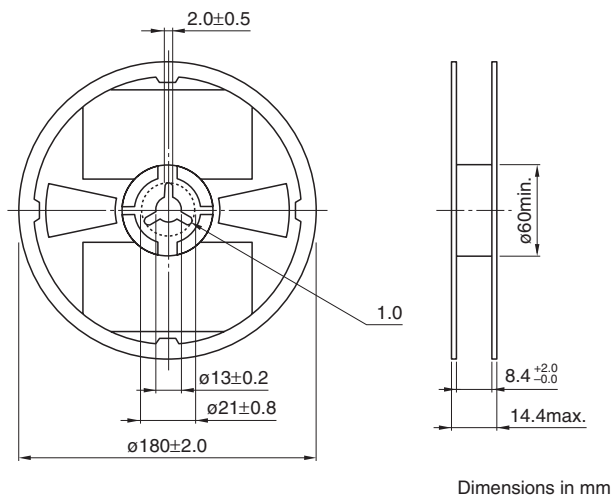

TAPE DIMENSIONS

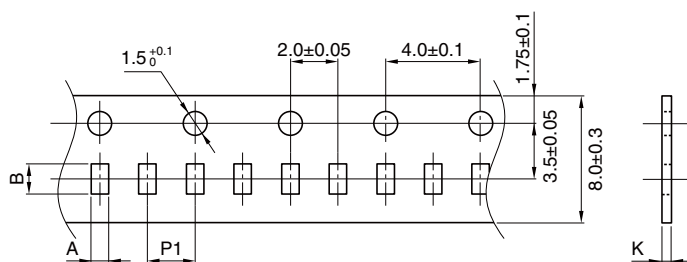

Type	A	B	P1	K
AVRM0402/AVRL0402	0.26±0.04	0.46±0.04	2.0±0.05	0.4max.
AVRM0603/AVRL0603	0.38±0.05	0.68±0.05	2.0±0.05	0.45max.
AVRM1005/AVRL1005	0.65±0.1	1.15±0.1	2.0±0.05	0.65max.
AVRM1608/AVRL1608	1.1±0.2	1.9±0.2	4.0±0.1	1.1max.
AVRM2012	1.6±0.2	2.3±0.2	4.0±0.1	1.7max.

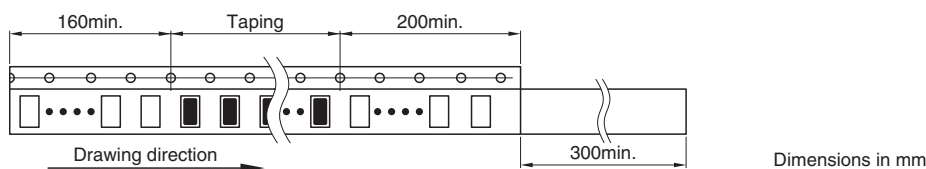

• All specifications are subject to change without notice.

Looking for pricing, stock, or lifecycle information?

Click below to explore more details on WIN SOURCE:

- ⊖ [View AVR-M1005C270MTAAB on WIN SOURCE](#)
- ⊖ [TDK Corporation](#) Information

Optimize Your Supply Chain with WIN SOURCE Solutions

- ✓ Global Sourcing Solution
- ✓ Obsolete Management
- ✓ Cost Control Management
- ✓ Shortage Management
- ✓ Alternative Solution
- ✓ Excess Inventory Management