



**THE DATASHEET OF
NDS6D2412EC**





FEATURES

- UL 60950 recognized
- RoHS compliant
- 2:1 Wide range voltage input
- Operating temperature range -40°C to 85°C
- Short circuit protection
- 0.2% Typical load regulation
- 1.5kVDC Isolation 'Hi-Pot Test'
- 24V Nominal input
- Single & dual outputs
- Power density 0.94W/cm³
- Optional remote On/Off
- UL 94V-0 Package materials
- No electrolytic capacitors
- Low noise

PRODUCT OVERVIEW

The NDS6 series of DC/DC converters offer single and dual output voltages from an input voltage range of 18-36V. The NDS6 is housed in an industry standard package with a standard pinout. The NDS6 is packaged in a metal case for improved EMI shielding and is also encapsulated for superior thermal performance. Versions with optional remote on/off control pin are also available.

Applications include telecommunications, battery powered systems, process control and distributed power systems.



For full details go to www.murata-ps.com/rohs

SELECTION GUIDE

Order Code ²	Input Voltage	Output Voltage	Output Current		Input Current			Ripple & Noise	Efficiency		MTTF ¹
	Nom.		Min. Load	±100% Load	0% Load	100% Load	Shut Down		Min.	Typ.	
	V	A	A	A	mA	mA	mA	mV p-p	%	%	kHrs
NDS6D2405C	24	±5	±0.06	±0.6	7	300	1.1	40	80	82	
NDS6D2412C	24	±12	±0.025	±0.250	7	290	1.1	40	85	87	
NDS6D2415C	24	±15	±0.020	±0.200	7	290	1.1	45	85	87	
NDS6S2405C	24	5	0.12	1.2	4	305	1.1	40	80	82	
NDS6S2412C	24	12	0.05	0.5	5.5	290	1.1	40	84	86	
NDS6S2415C	24	15	0.04	0.4	6	290	1.1	40	85	87	

INPUT CHARACTERISTICS

Parameter	Conditions	Min.	Typ.	Max.	Units
Voltage range	All NDS6D24 & NDS6S24 types	18	24	36	V
Reflected ripple current	All NDS6D24 & NDS6S24 types		7		mA p-p

OUTPUT CHARACTERISTICS

Parameter	Conditions	Min.	Typ.	Max.	Units
Rated power				6	W
Voltage set point accuracy	Positive & negative except NDS6D2405 negative output			±2	%
	NDS6D2405 negative output			±4	%
Line regulation	Low line to high line	Positive outputs	0.01	0.1	%
		Negative outputs	0.02	0.2	
Load regulation	10% total load to 100% total load	5V outputs	0.2	1.7	%
		12V & 15V outputs	0.2	1	
Cross regulation	% voltage change on negative output when positive load varies from 12.5% (0.75W) to 37.5% (2.25W) with negative load fixed at 50% (3W)	5V		5	%
		12V & 15V		2	

ISOLATION CHARACTERISTICS

Parameter	Conditions	Min.	Typ.	Max.	Units
Isolation test voltage	Flash tested for 1 second	1500			VDC
Resistance	Viso = 1kVDC	1			GΩ
Capacitance			225		pF

ABSOLUTE MAXIMUM RATINGS

Short-circuit protection	Continuous
Internal power dissipation	2.7W
Lead temperature 1.0mm from case for 10 seconds (to JEDEC JESD22-B106 ISS C)	260°C
Minimum output load for specification ³	10% of rated load on each output
Control pin input voltage	±18V
Input voltage, NDS6 24V input types	40V

1 Calculated using MIL-HDBK-217F with nominal input voltage at full load.

2 To order with optional control pin, prefix C with "E". For example NDS6D0505EC.

3 Operation below 10% minimum load may cause increased output ripple.

All specifications typical at T_A=25°C, nominal input voltage and rated output current unless otherwise specified.

GENERAL CHARACTERISTICS ¹						
Parameter	Conditions	Min.	Typ.	Max.	Units	
Switching frequency			130		kHz	
Control pin input	Module ON (or pin unconnected)	3.0			V	
				0	mA	
	Module OFF			0.8	V	
				1.5	mA	

TEMPERATURE CHARACTERISTICS						
Parameter	Conditions	Min.	Typ.	Max.	Units	
Operation		-40		85	°C	
Storage		-50		130		
Case temperature rise above ambient	100% Load, Nom V _{IN} , Still Air,	5V	29			
		12V & 15V	22			
Thermal shutdown	Case Temperature		110			

APPLICATION NOTES									
<p>Control Pin</p> <p>This provides an OFF function, which puts the converter into a low power mode, when the voltage applied to the pin is less than 0.8V. When the pin is high or un-connected, the converter is on.</p>	<p>NDS6D Cross Regulation</p> <p>Load regulation is at its best when the positive and negative loads are balanced. When the loads are asymmetric, the negative output is not as tightly regulated as the positive output. To meet datasheet specification, a minimum load of 10% of output load current is required on each output. The NDS6D can be used with much lighter loading but the negative output voltage may rise above maximum datasheet specification.</p>								
<p>Output Capacitors</p> <p>The NDS6 series does not require output capacitors to meet datasheet specification. To meet datasheet specification, output capacitance should not exceed:</p> <table border="1"> <thead> <tr> <th>Output Voltage (V)</th> <th>Output Capacitance (µF)</th> </tr> </thead> <tbody> <tr> <td>5</td> <td>470</td> </tr> <tr> <td>12</td> <td>470</td> </tr> <tr> <td>15</td> <td>220</td> </tr> </tbody> </table>		Output Voltage (V)	Output Capacitance (µF)	5	470	12	470	15	220
Output Voltage (V)	Output Capacitance (µF)								
5	470								
12	470								
15	220								

TECHNICAL NOTES
<p>ISOLATION VOLTAGE</p> <p>'Hi Pot Test', 'Flash Tested', 'Withstand Voltage', 'Proof Voltage', 'Dielectric Withstand Voltage' & 'Isolation Test Voltage' are all terms that relate to the same thing, a test voltage, applied for a specified time, across a component designed to provide electrical isolation, to verify the integrity of that isolation.</p> <p>Murata Power Solutions NDS6 series of DC/DC converters are all 100% production tested at their stated isolation voltage. This is 1.5kVDC for 1 second.</p> <p>A question commonly asked is, "What is the continuous voltage that can be applied across the part in normal operation?"</p> <p>The NDS6 has been recognized by Underwriters Laboratory for functional isolation. Both input and output should normally be maintained within SELV limits i.e. less than 42.4V peak, or 60VDC. The isolation test voltage represents a measure of immunity to transient voltages and the part should never be used as an element of a safety isolation system. The part could be expected to function correctly with several hundred volts offset applied continuously across the isolation barrier; but then the circuitry on both sides of the barrier must be regarded as operating at an unsafe voltage and further isolation/insulation systems must form a barrier between these circuits and any user-accessible circuitry according to safety standard requirements.</p> <p>REPEATED HIGH-VOLTAGE ISOLATION TESTING</p> <p>It is well known that repeated high-voltage isolation testing of a barrier component can actually degrade isolation capability, to a lesser or greater degree depending on materials, construction and environment. The NDS6 series has an ER ferrite core, with no additional insulation between primary and secondary windings of enameled wire. While parts can be expected to withstand several times the stated test voltage, the isolation capability does depend on the wire insulation. Any material, including this enamel (typically polyurethane) is susceptible to eventual chemical degradation when subject to very high applied voltages thus implying that the number of tests should be strictly limited. We therefore strongly advise against repeated high voltage isolation testing, but if it is absolutely required, that the voltage be reduced by 20% from specified test voltage.</p> <p>This consideration equally applies to agency recognized parts rated for better than functional isolation where the wire enamel insulation is always supplemented by a further insulation system of physical spacing or barriers.</p>

SAFETY APPROVAL

The NDS6 series has been recognised by Underwriters Laboratory (UL) to UL 60950 for functional insulation in a maximum ambient temperature of 85°C and/or case temperature limit of 120°C (case temperature measured on the face opposite the pins). File number E151252 applies.

Note: This series gained UL 60950 recognition for products manufactured on or after datecode G1148, any NDS6 parts manufactured before this date code should not be considered UL 60950 recognized. Any NDS6 that is UL recognized will be printed with the UL logo. 

RoHS COMPLIANCE INFORMATION



This series is compatible with RoHS soldering systems with a peak wave solder temperature of 260°C for 10 seconds. The pin termination finish on this product series is a Gold flash (0.05-0.10 micron) over Nickel Preplate. The series is backward compatible with Sn/Pb soldering systems. For further information, please visit www.murata-ps.com/rohs

CHARACTERISATION TEST METHODS

Ripple & Noise Characterisation Method

Ripple and noise measurements are performed with the following test configuration.

C1	1µF X7R multilayer ceramic capacitor, voltage rating to be a minimum of 3 times the output voltage of the DC/DC converter
C2	10µF tantalum capacitor, voltage rating to be a minimum of 1.5 times the output voltage of the DC/DC converter with an ESR of less than 100mΩ at 100 kHz
C3	100nF multilayer ceramic capacitor, general purpose
R1	450Ω resistor, carbon film, +/-1% tolerance
R2	50Ω BNC termination
T1	3T of the coax cable through a ferrite toroid
RLOAD	Resistive load to the maximum power rating of the DC/DC converter. Connections should be made via twisted wires

Measured values are multiplied by 10 to obtain the specified values.

Differential Mode Noise Test Schematic

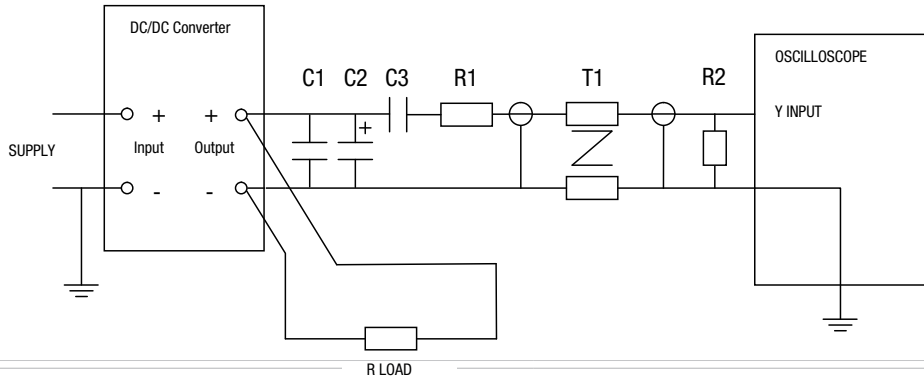

EFFICIENCY VS LOAD

NDS 24V Input, Dual Output

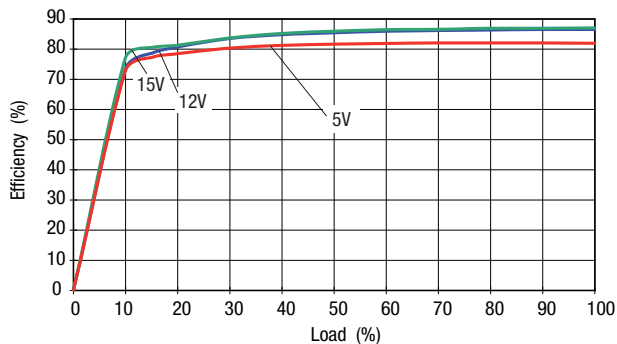

NDS 24V Input, Single Output

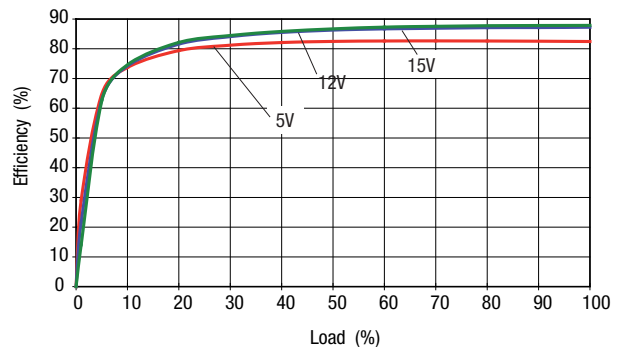

TEMPERATURE DERATING

NDS6D2405C

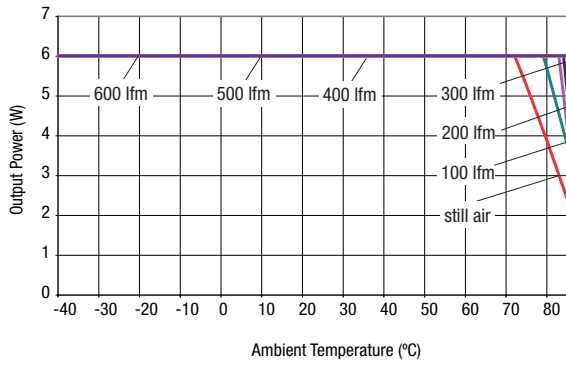

NDS6D2412C

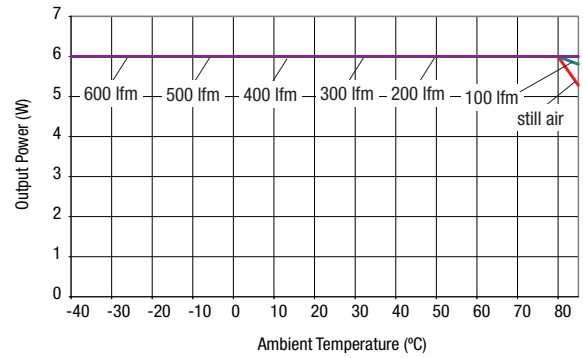

NDS6D2415C

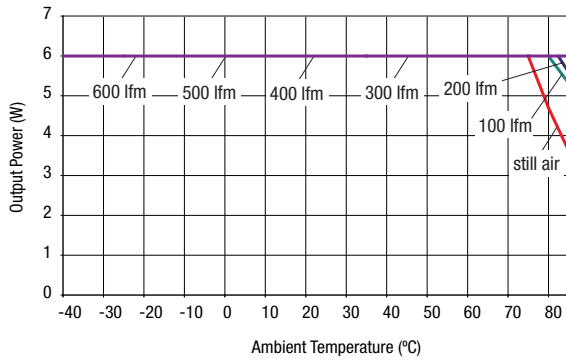

NDS6S2405C

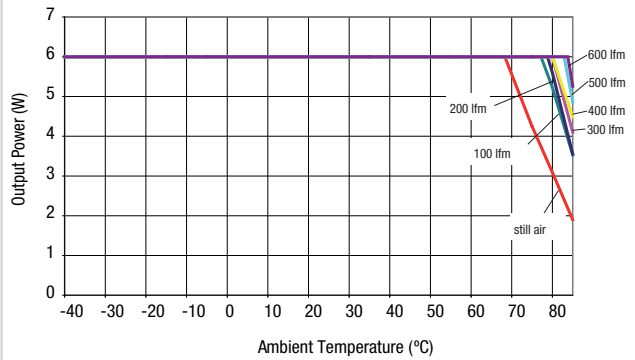

NDS6S2412C

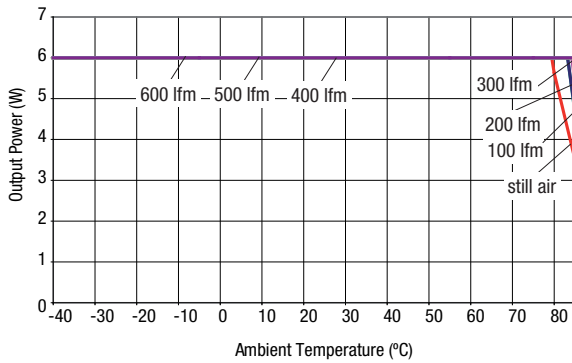

NDS6S2415C

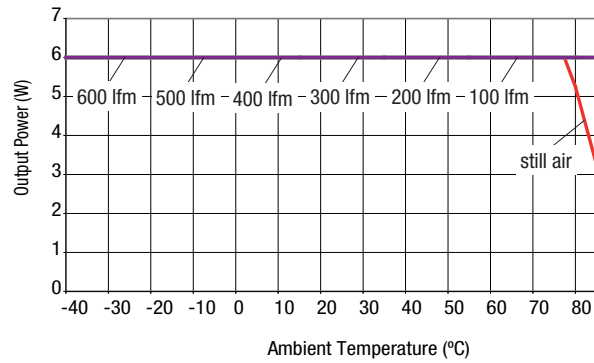

EMC FILTERING AND SPECTRA

FILTERING

The module includes a basic level of filtering, typically sufficient to meet EN 55022 Curve A Quasi-Peak EMC limit, as shown in the following plots.

NDS6S2405C

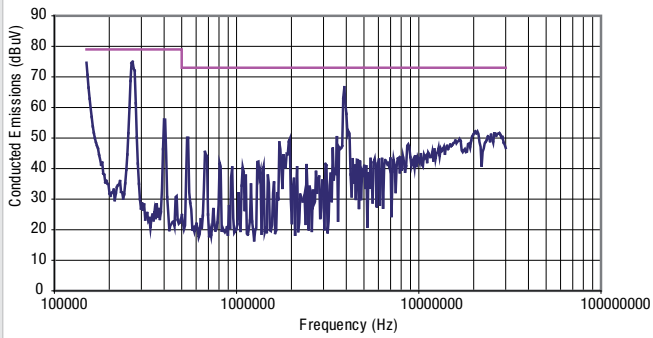

NDS6S2412C

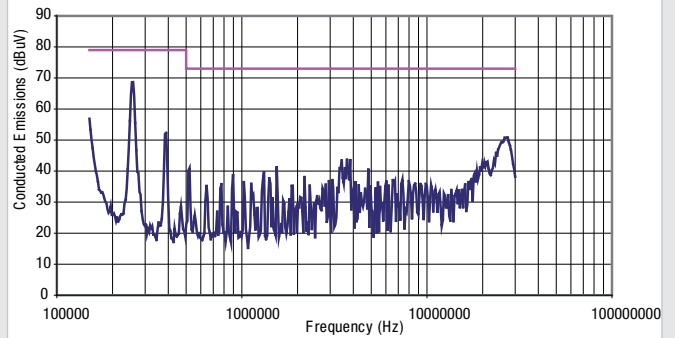

NDS6S2415C

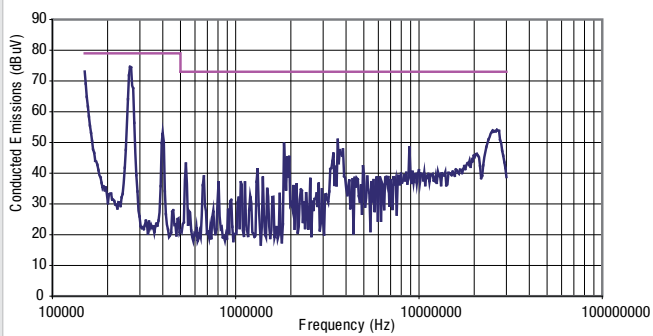

NDS6D2405C

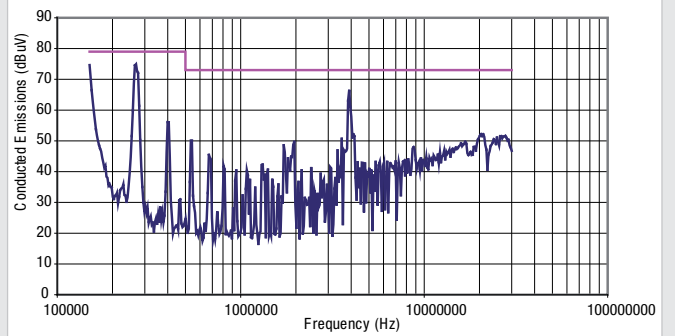

NDS6D2412C

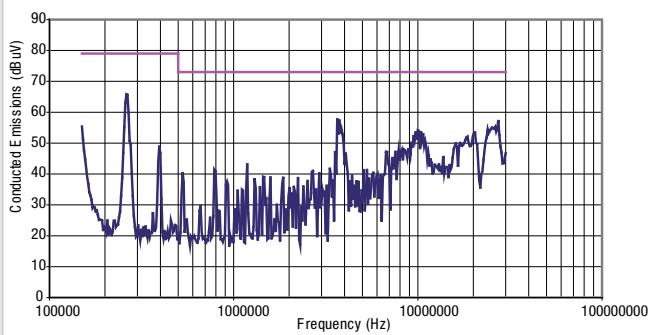

NDS6D2415C

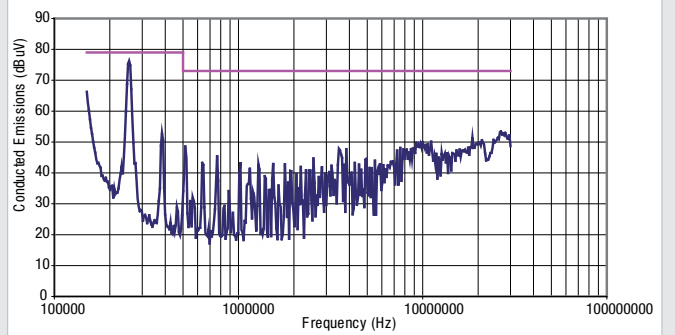

PACKAGE SPECIFICATIONS

MECHANICAL DIMENSIONS

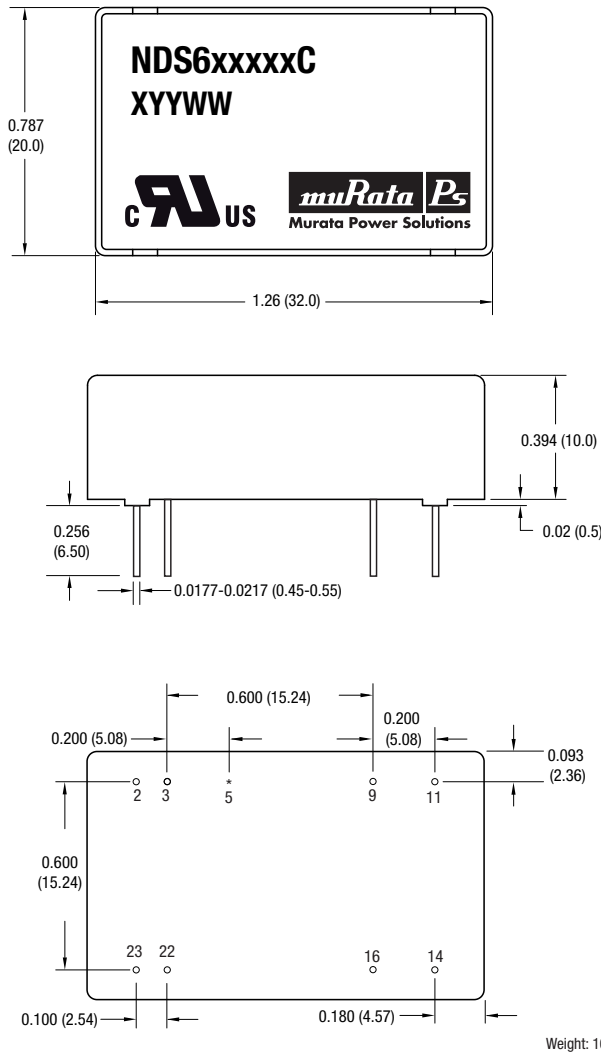

All dimensions in mm (inches) ± 0.5 (0.020) except pin to pin tolerance ± 0.25 (0.010).
 All pins on a 2.54 (0.100) pitch and within 0.25 (0.010) of true position.
 The copper case is connected to the output (-V_{OUT}) pin. Care is needed in the design of this circuit board on which the converter is mounted. Top side tracks must not contact the edge of the case on the underside of the unit.
 Please note that from 2010 onwards, you may receive either a blue or a black case.

PIN CONNECTIONS

Pin	Function	
	Single	Dual
2	-V _{IN}	-V _{IN}
3	-V _{IN}	-V _{IN}
5*	On/Off	On/Off
9	No pin	0V
11	N/C	-V _{OUT}
14	+V _{OUT}	+V _{OUT}
16	-V _{OUT}	0V
22	+V _{IN}	+V _{IN}
23	+V _{IN}	+V _{IN}

* Optional pin

TUBE OUTLINE DIMENSIONS

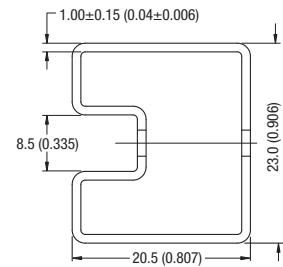

Tube length 520 (20.47)
 All dimensions in mm ± 0.25 mm (inches ± 0.010). Quantity: 15

RECOMMENDED FOOTPRINT DETAILS

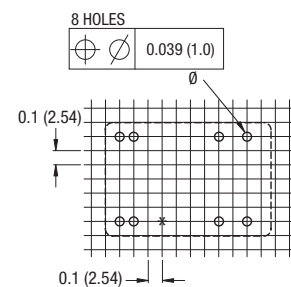

* Optional pin
 All dimensions in mm ± 0.25 mm (inches ± 0.010).

Murata Power Solutions, Inc.
 11 Cabot Boulevard, Mansfield, MA 02048-1151 U.S.A.
 ISO 9001 and 14001 REGISTERED





This product is subject to the following **operating requirements** and the **Life and Safety Critical Application Sales Policy**:
 Refer to: <http://www.murata-ps.com/requirements/>

Murata Power Solutions, Inc. makes no representation that the use of its products in the circuits described herein, or the use of other technical information contained herein, will not infringe upon existing or future patent rights. The descriptions contained herein do not imply the granting of licenses to make, use, or sell equipment constructed in accordance therewith. Specifications are subject to change without notice.
 © 2015 Murata Power Solutions, Inc.

Looking for pricing, stock, or lifecycle information?

Click below to explore more details on WIN SOURCE:

-  [View NDS6D2412EC on WIN SOURCE](#)
-  [Murata Power Solutions Inc. Information](#)

Optimize Your Supply Chain with WIN SOURCE Solutions

-  Global Sourcing Solution
-  Obsolete Management
-  Cost Control Management
-  Shortage Management
-  Alternative Solution
-  Excess Inventory Management