

High Quality Audio Dual Operational Amplifier

■GENERAL DESCRIPTION

The NJM8801 is a high quality audio dual operational Amplifier with bipolar technology, strikes a balance between "MUSES technology" and mass-production technique.

The original process tuning and the assembly technology, based on MUSES technology, make excellent sound and absorbing cost increases.

The characteristics like Low noise ($4.5\text{nV}/\sqrt{\text{Hz}}$), Wide Bandwidth (15MHz) and low distortion (0.0005%) suitable for audio preamplifiers, active filters, and line amplifiers.

NJM8801 packages are SOP8 JEDEC 150 mil and small SSOP8 with copper frame.

■PACKAGE OUTLINE



NJM8801E
(SOP8 JEDEC 150 mil)



NJM8801VA3
(SSOP8)

■FEATURES

- Operating Voltage $\pm 2\text{V}$ to $\pm 18\text{V}$
- Low Noise Voltage $4.5\text{nV}/\sqrt{\text{Hz}}$ typ.
 $0.8\mu\text{Vrms}$ typ. (RIAA)
- Low Distortion 0.0005% typ.
- Wide GB 15MHz typ.
- Slew Rate $5\text{V}/\mu\text{s}$ typ.
- Input Offset Voltage 0.3mV typ. 3mV max.
- Input Bias Current 100nA typ. 500nA max.
- Voltage Gain 110dB typ.
- Bipolar Technology
- Package Outline SOP8 JEDEC 150 mil, SSOP8-A3 (copper frame)

■PIN CONFIGURATION

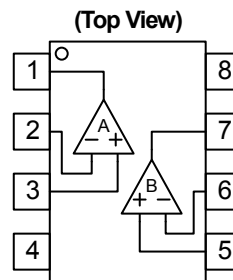

- PIN FUNCTION**
1. A OUTPUT
 2. A -INPUT
 3. A +INPUT
 4. V-
 5. B +INPUT
 6. B -INPUT
 7. B OUTPUT
 8. V+

■EQUIVALENT CIRCUIT (1/2 Shown)

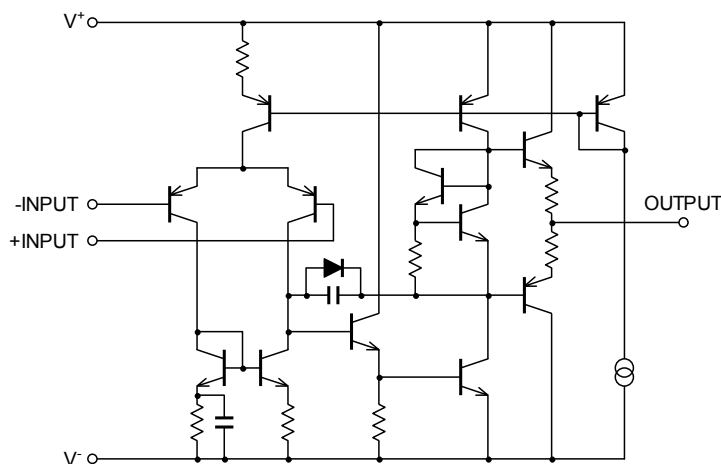

NJM8801

■ABSOLUTE MAXIMUM RATINGS (Ta=25°C)

PARAMETER	SYMBOL	RATING	UNIT
Supply Voltage	V _{DD}	±18	V
Common Mode Input Voltage Range	V _{ICM}	±15 (Note1)	V
Differential Input Voltage Range	V _{ID}	±30	V
Power Dissipation	P _D	SOP8 JEDEC 150 mil: 550 (Note2) SSOP8: 460 (Note2)	mW
Operating Temperature Range	T _{OPR}	-40~+85	°C
Storage Temperature Range	T _{STG}	-40~+125	°C

(Note 1) For supply Voltages less than ±15V, the maximum input voltage is equal to the Supply Voltage.

(Note 2) Mounted on the EIA/JEDEC standard board (114.3×76.2×1.6mm, two layer, FR-4).

Refer to the following Power Dissipation and Ambient Temperature.

■RECOMMENDED OPERATING CONDITION (Ta=25°C)

PARAMETER	SYMBOL	TEST CONDITION	MIN.	TYP.	MAX.	UNIT
Supply Voltage	V ⁺ /V ⁻		±2	-	±18	V

■ELECTRIC CHARACTERISTICS

●DC CHARACTERISTICS (V⁺/V⁻=±15V, V_{cm}=0V, Ta=25°C, unless otherwise specified)

PARAMETER	SYMBOL	TEST CONDITION	MIN.	TYP.	MAX.	UNIT
Supply Current	I _{CC}	R _L =∞, No Signal	-	6	9	mA
Input Offset Voltage	V _{IO}	R _s ≤10kΩ (Note3)	-	0.3	3	mV
Input Bias Current	I _B		-	100	500	nA
Input Offset Current	I _{IO}	(Note3)	-	5	200	nA
Voltage Gain	A _V	R _L ≥2kΩ, V _o =±10V, R _s ≤10kΩ	90	110	-	dB
Common Mode Rejection Ratio	CMR	V _{ICM} =±12V, R _s ≤10kΩ	80	110	-	dB
Supply Voltage Rejection Ratio	SVR	V ⁺ /V ⁻ =±9.0 to ±18V, R _s ≤10kΩ	80	110	-	dB
Maximum Output Voltage	V _{OM}	R _L ≥2kΩ	±12	±13.5	-	V
Common Mode Input Voltage Range	V _{ICM}	CMR≥80dB	±12	±13.5	-	V

(Note3) Written by the absolute rate.

●AC CHARACTERISTICS (V⁺/V⁻=±15V, V_{cm}=0V, Ta=25°C unless otherwise specified)

PARAMETER	SYMBOL	TEST CONDITION	MIN.	TYP.	MAX.	UNIT
Slew Rate	SR	R _L ≥2kΩ	-	5	-	V/us
Gain Bandwidth Product	GB	f=10kHz	-	15	-	MHz
Equivalent Input Noise Voltage	e _n	R _S =100Ω, f=1kHz	-	4.5	-	nV/√Hz
Equivalent Input Noise Voltage	V _{NI}	RIAA, R _S =2.2kΩ, 30kHz, LPF, NJM8801VA3	-	0.8	-	μVrms
Equivalent Input Noise Voltage	V _{NI}	RIAA, R _S =2.2kΩ, 30kHz, LPF, NJM8801E	-	0.8	1.4	μVrms
Total Harmonic Distortion	THD	f=1kHz, A _V =+10, V _o =5Vrms, R _L =2kΩ	-	0.0005	-	%
Channel Separation	CS	f=1kHz, A _V =-100, R _S =1kΩ, R _L =2kΩ	-	130	-	dB

■Application Notes

●Package Power, Power Dissipation and Output Power

IC is heated by own operation and possibly gets damage when the junction power exceeds the acceptable value called Power Dissipation P_D . The dependence P_D on ambient temperature is shown in Fig 1. The plots are depended on following two points. The first is P_D on ambient temperature 25°C, which is the maximum power dissipation. The second is 0W, which means that the IC cannot radiate any more. Conforming the maximum junction temperature T_{jmax} to the storage temperature T_{stg} derives this point. Fig.1 is drawn by connecting those points and conforming the P_D lower than 25°C to it on 25°C. The P_D is shown following formula as a function of the ambient temperature between those points.

$$\text{Dissipation Power } P_D = \frac{T_{jmax} - T_a}{\theta_{ja}} \text{ [W]} \quad (T_a=25^\circ\text{C to } T_a=T_{jmax})$$

Where, θ_{ja} is heat thermal resistance which depends on parameters such as package material, frame material and so on. Therefore, P_D is different in each package.

While, the actual measurement of dissipation power on IC is obtained using following equation.

$$(\text{Actual Dissipation Power}) = (\text{Supply Voltage } V \times I) - (\text{Output Power } P_o)$$

This IC should be operated in lower than P_D of the actual dissipation power.

To sustain the steady state operation, take account of the Dissipation Power and thermal design.

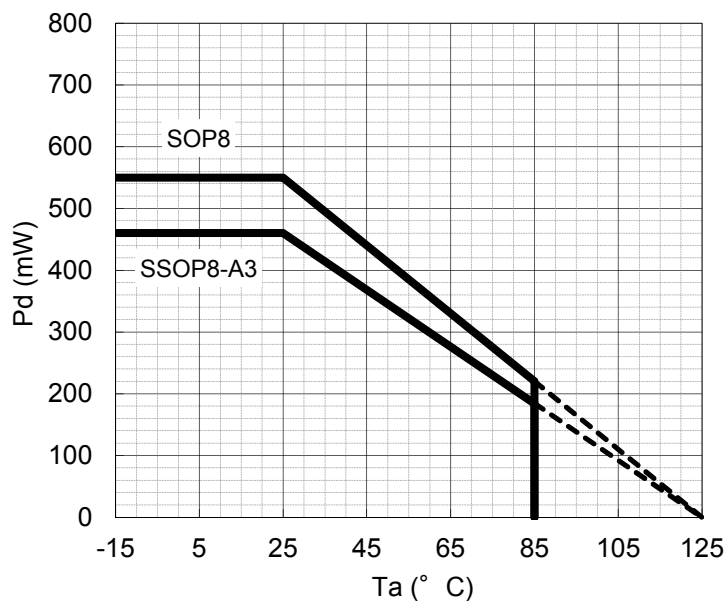
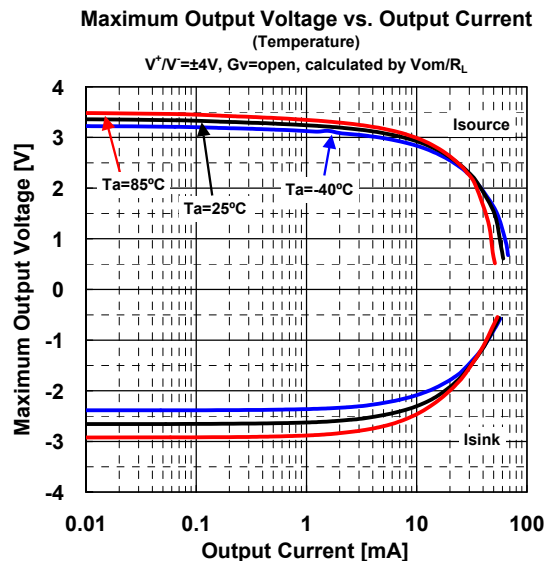
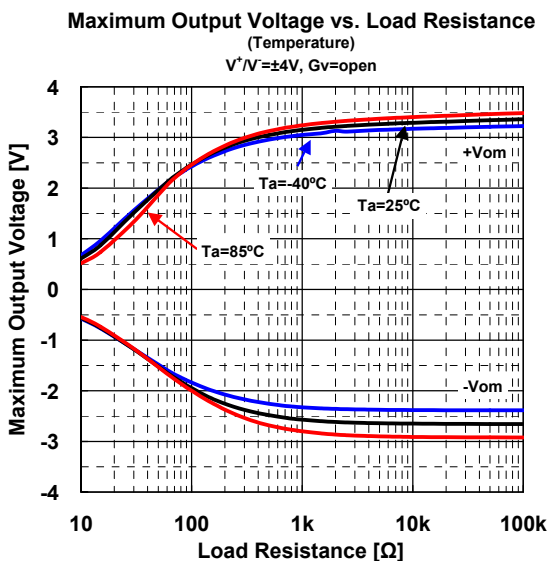
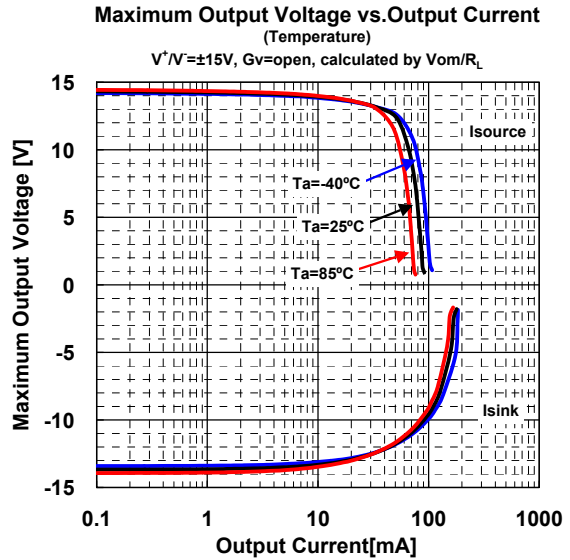
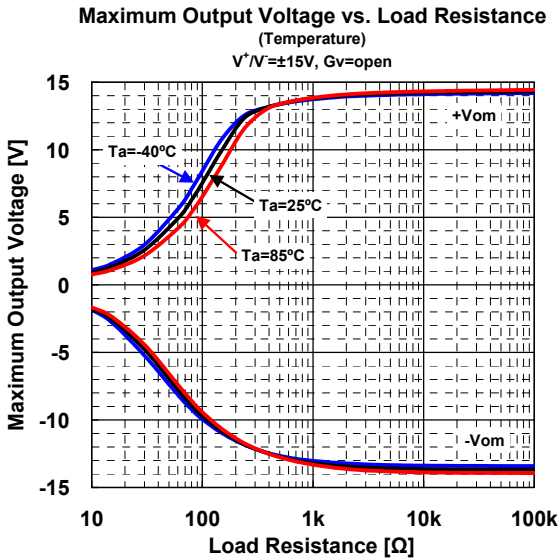
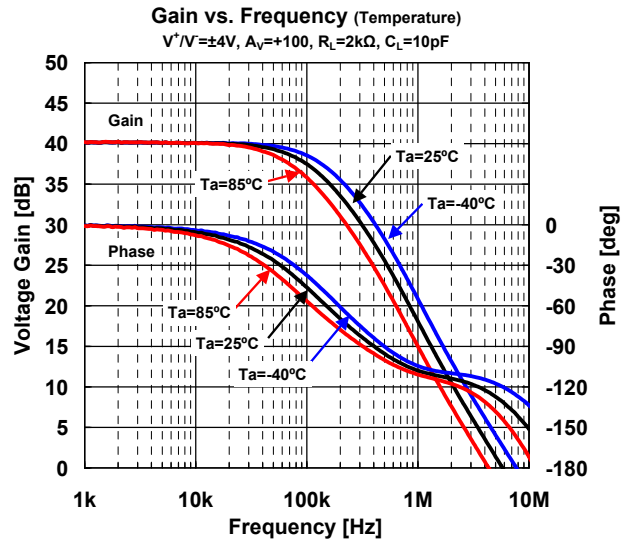
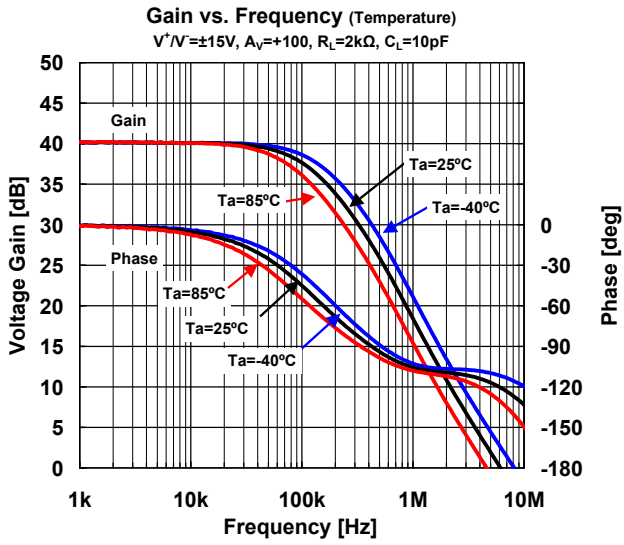
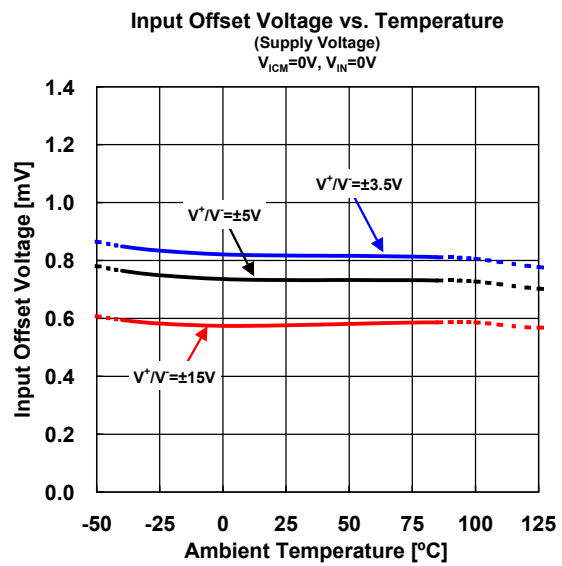
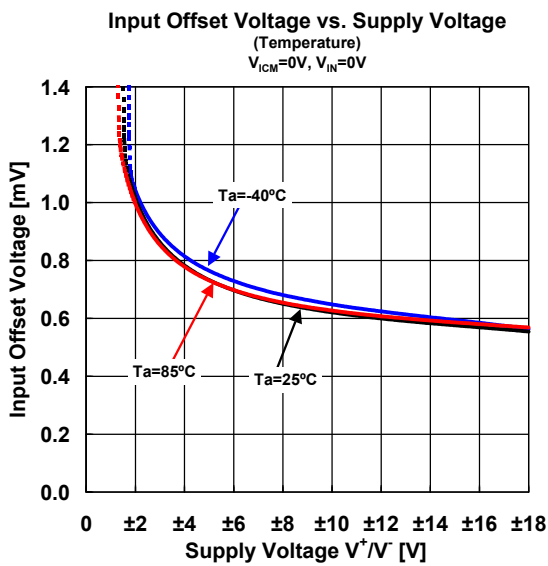
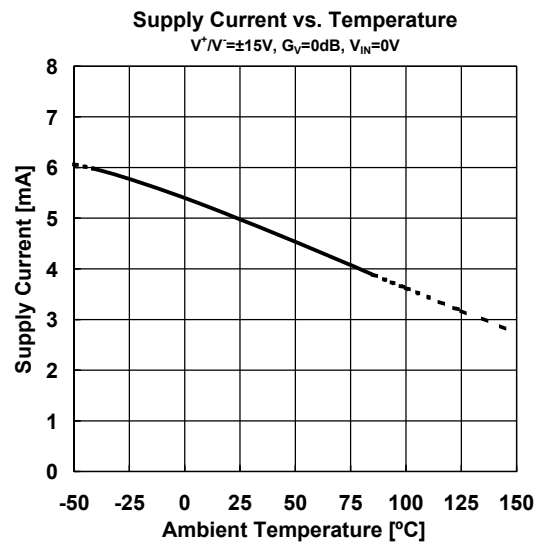
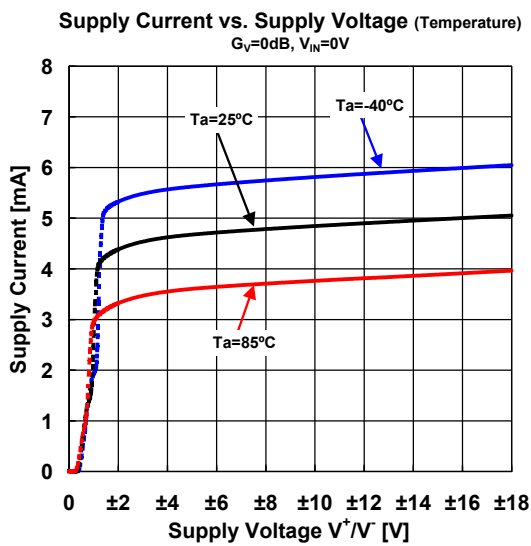
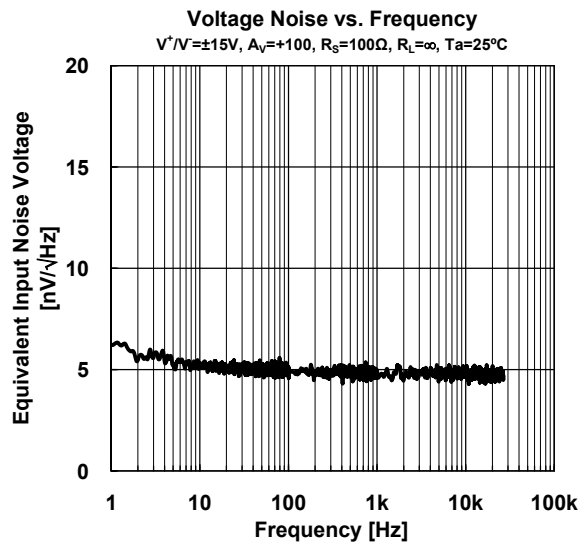
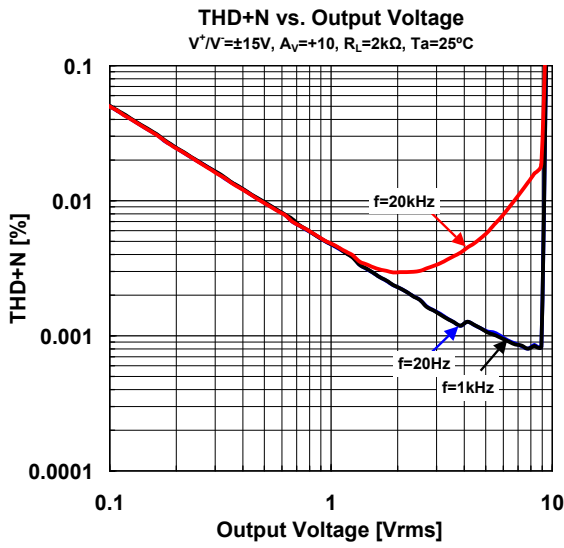

Fig.1 Power Dissipations vs. Ambient Temperature

TYPICAL CHARACTERISTICS



■ TYPICAL CHARACTERISTICS



TYPICAL CHARACTERISTICS

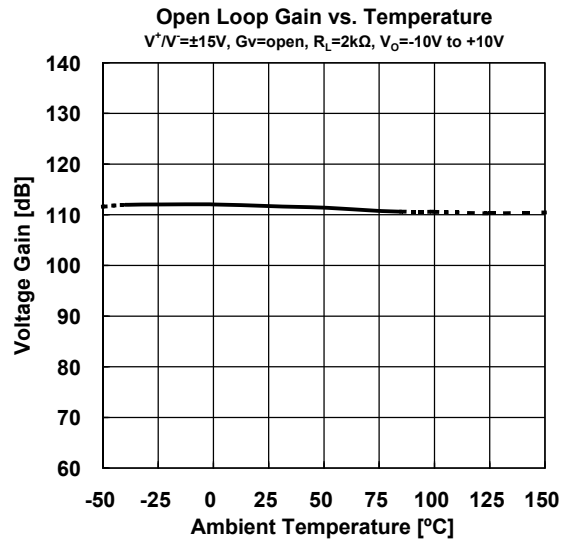
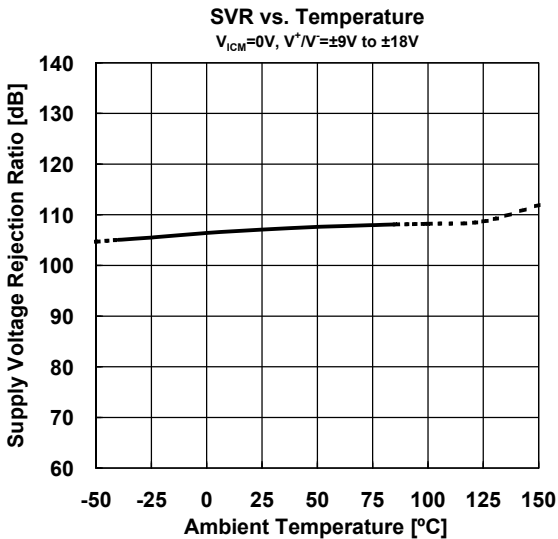
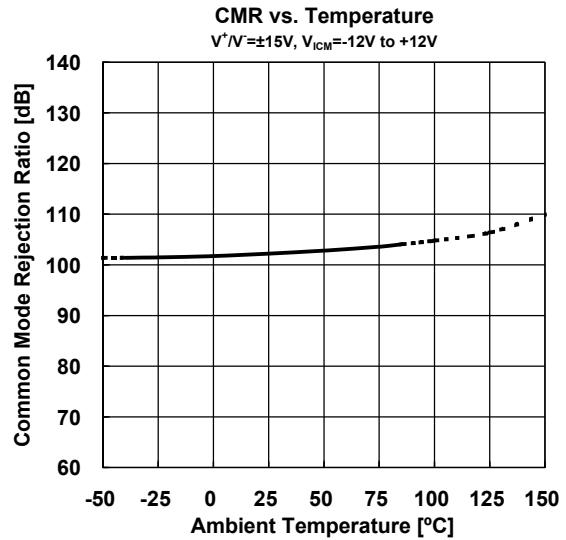
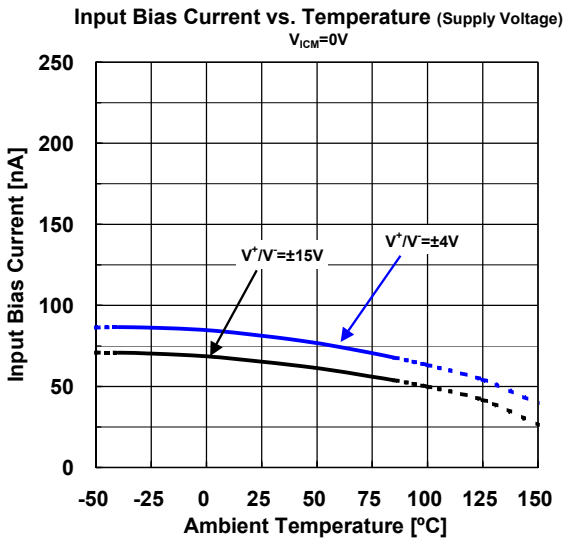
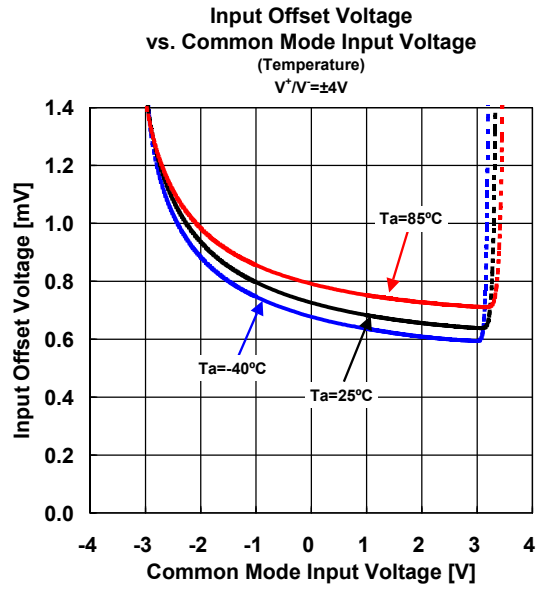
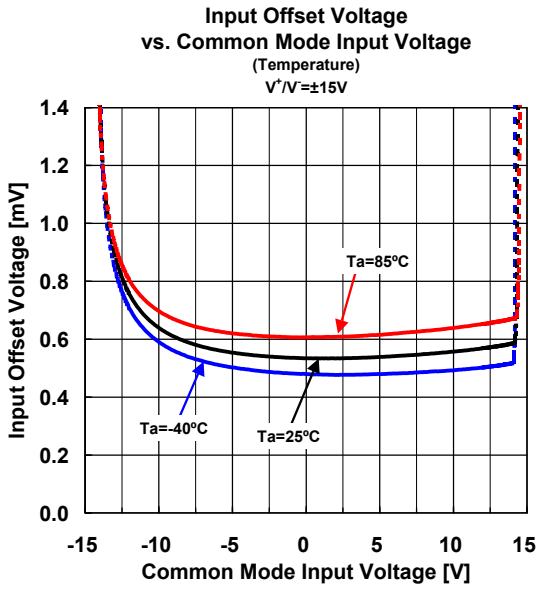

■ TYPICAL CHARACTERISTICS

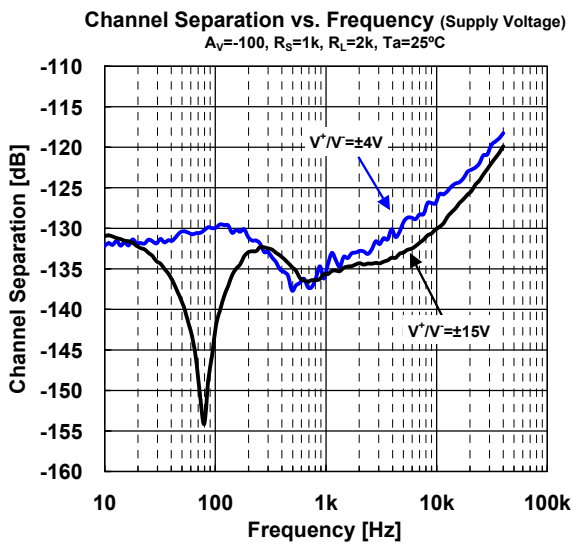
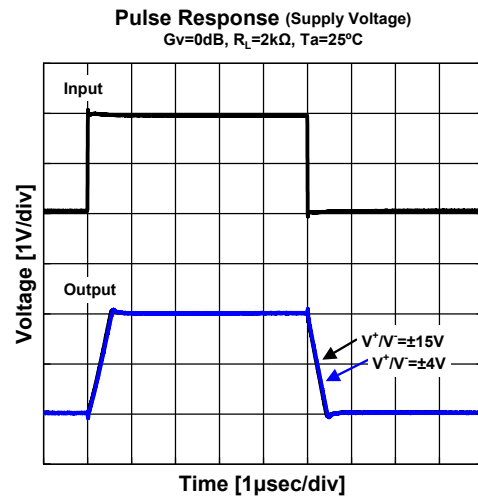
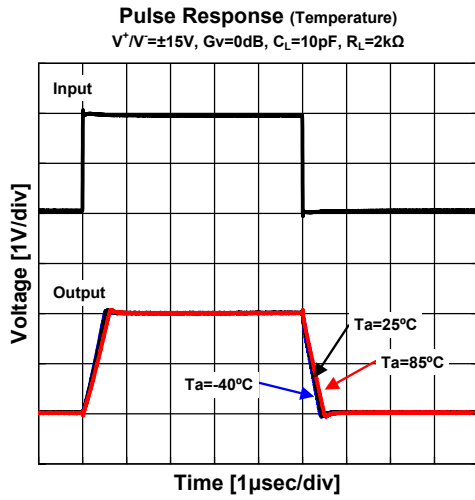

[CAUTION]

The specifications on this databook are only given for information, without any guarantee as regards either mistakes or omissions. The application circuits in this databook are described only to show representative usages of the product and not intended for the guarantee or permission of any right including the industrial rights.

Looking for pricing, stock, or lifecycle information?

Click below to explore more details on WIN SOURCE:

- ⊖ [View NJM8801E on WIN SOURCE](#)
- ⊖ [NJR Corporation/NJRC Information](#)

Optimize Your Supply Chain with WIN SOURCE Solutions

- ✓ Global Sourcing Solution
- ✓ Obsolete Management
- ✓ Cost Control Management
- ✓ Shortage Management
- ✓ Alternative Solution
- ✓ Excess Inventory Management