

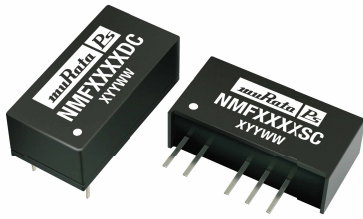

THE DATASHEET OF NMF0505SC





FEATURES

- Output regulation <1.5%
- Output programmable
- Single isolated output
- SIP & DIP package style
- 1kVDC isolation 'Hi Pot Test'
- 5V, 12V & 24V input
- 5V, 12V & 15V output
- SMD construction
- No external components required
- MTTF up to 2.4 million hours

DESCRIPTION

The NMF series of DC-DC converters is used where a tightly regulated supply is required. They are ideal for situations where the input voltage is not tightly controlled. The output trim pin makes the device particularly suitable for applications requiring a programmable output voltage. The 5V output version can be used to give a regulated output, adjustable between 1.2V and 5.0V with a single resistor.

SELECTION GUIDE

Order Code	Nominal Input Voltage	Output Voltage	Output Current	Power Out	Efficiency	Isolation Capacitance	MTTF ¹	Package Style	
	V	V	mA	mW	%	pF	kHrs		
In Production									
NMF0505DC	5	5	100	500	50	37	1307	DIP	
NMF0515DC	5	15	67	1000	62	52	316	DIP	
NMF0505SC	5	5	100	500	50	37	1307	SIP	
NMF0512SC	5	12	83	1000	62	46	512	SIP	
NMF0515SC	5	15	67	1000	62	52	316	SIP	
NMF1205DC	12	5	100	500	50	62	456	DIP	
NMF1215DC	12	15	67	1000	62	108	218	DIP	
NMF1205SC	12	5	100	500	50	62	456	SIP	
NMF1212SC	12	12	83	1000	62	98	290	SIP	
NMF1215SC	12	15	67	1000	62	108	218	SIP	
NMF2405DC	24	5	100	500	50	69	843	DIP	
NMF2405SC	24	5	100	500	50	69	843	SIP	
NMF2412SC	24	12	83	1000	62	129	422	SIP	
NMF2415SC	24	15	67	1000	62	151	279	SIP	
Discontinued									
NMF0509DC	5	9	100	900	62	42	825	DIP	Recommended Alternative Contact Murata
NMF0509SC	5	9	100	900	62	42	825	SIP	Contact Murata
NMF1209DC	12	9	100	900	62	82	379	DIP	Contact Murata
NMF1209SC	12	9	100	900	62	82	379	SIP	Contact Murata
NMF4805DC	48	5	100	500	50	51	200	DIP	Contact Murata
NMF4809DC	48	9	100	900	62	86	283	DIP	Contact Murata
NMF4812DC	48	12	83	1000	62	108	162	DIP	Contact Murata
NMF4815DC	48	15	67	1000	62	127	135	DIP	Contact Murata
NMF4805SC	48	5	100	500	50	51	200	SIP	Contact Murata
NMF4809SC	48	9	100	900	62	86	283	SIP	Contact Murata
NMF4812SC	48	12	83	1000	62	108	162	SIP	Contact Murata
NMF4815SC	48	15	67	1000	62	127	135	SIP	Contact Murata
NMF0512DC	5	12	83	1000	62	46	512	DIP	NMF0512SC
NMF1212DC	12	12	83	1000	62	98	290	DIP	NMF1212SC
NMF2409DC	24	9	100	900	62	106	613	DIP	Contact Murata
NMF2409SC	24	9	100	900	62	106	613	SIP	Contact Murata
NMF2412DC	24	12	83	1000	62	129	422	DIP	NMF2412SC
NMF2415DC	24	15	67	1000	62	151	279	DIP	NMF2415SC

When operated **with** additional external load capacitance the rise time of the input voltage will determine the maximum external capacitance value for guaranteed start up. The slower the rise time of the input voltage the greater the maximum value of the additional external capacitance for reliable start up.



For full details go to www.murata-ps.com/rohs

1. Calculated using MIL-HDBK-217F with nominal input voltage at full load.
 2. Supply voltage must be discontinued at the end of the short circuit duration.
- All specifications typical at T_a=25°C, nominal input voltage and rated output current unless otherwise specified.

ABSOLUTE MAXIMUM RATINGS

Short-circuit protection ²	1 second
Lead temperature 1.5mm from case for 10 seconds	260°C
Input voltage V _{IN} , NMF05 types	7V
Input voltage V _{IN} , NMF12 types	15V
Input voltage V _{IN} , NMF24 types	28V

INPUT CHARACTERISTICS

Parameter	Conditions	Min.	Typ.	Max.	Units
Voltage range	Continuous operation, 5V input types	4.75	5	5.25	V
	Continuous operation, 12V input types	11.4	12	12.6	
	Continuous operation, 24V input types	22.8	24	25.2	

OUTPUT CHARACTERISTICS

Parameter	Conditions	Min.	Typ.	Max.	Units
Voltage set point accuracy	100% load			5	%
Rated power	T _A = 0°C to 70°C, see derating graph			1	W
Line regulation	High V _{IN} to low V _{IN}			0.25	%/%
Load regulation	10% load to rated load		0.9	1.5	%
Ripple & noise	BW=DC to 20MHz, all output types			60	mV p-p

ISOLATION CHARACTERISTICS

Parameter	Conditions	Min.	Typ.	Max.	Units
Isolation test voltage	Flash tested for 1 second	1000			VDC
Resistance	Viso= 500VDC	0.1			GΩ

GENERAL CHARACTERISTICS

Parameter	Conditions	Min.	Typ.	Max.	Units
Switching frequency	All input types		90		kHz

TEMPERATURE CHARACTERISTICS

Parameter	Conditions	Min.	Typ.	Max.	Units
Specification	All output types	0		70	°C
Case temperature above ambient			38		
Storage		-55		150	
Cooling	Free air convection				

OUTPUT VOLTAGE ADJUSTMENT (for 5V output variants)

The trimming (adjust) input on the device allows output voltage adjustment from 1.2V to 3.3VDC by using a resistor as shown here. The table below provides R_{TRIM} values for the most commonly required output voltages. For applications not requiring the TRIM function, this pin must be left unconnected for normal regulated output.

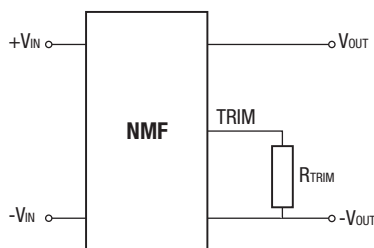

V _{OUT SET} (V)	R _{TRIM} (Ω)
1.2	0
1.5	64
2.0	224
2.1	263
2.2	304
2.5	448
3.3	1071

TYPICAL APPLICATIONS

Pressure sensor, or strain gauge equivalent circuit

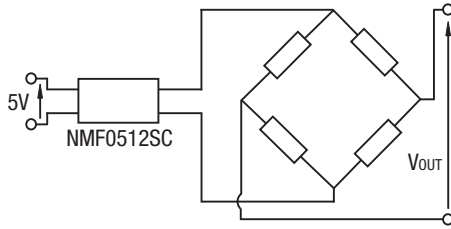

Scmitt Trigger

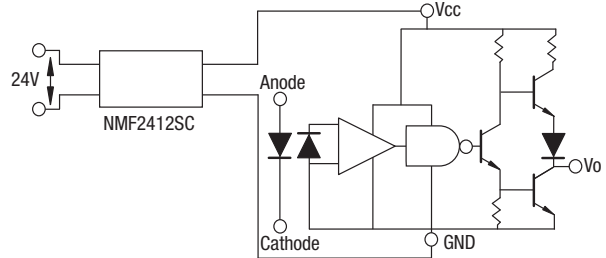

TECHNICAL NOTES

ISOLATION VOLTAGE

'Hi Pot Test', 'Flash Tested', 'Withstand Voltage', 'Proof Voltage', 'Dielectric Withstand Voltage' & 'Isolation Test Voltage' are all terms that relate to the same thing, a test voltage, applied for a specified time, across a component designed to provide electrical isolation, to verify the integrity of that isolation.

Murata Power Solutions NMF series of DC-DC converters are all 100% production tested at their stated isolation voltage. This is 1kVDC for 1 second.

A question commonly asked is, "What is the continuous voltage that can be applied across the part in normal operation?"

For a part holding no specific agency approvals, such as the NMF series, both input and output should normally be maintained within SELV limits i.e. less than 42.4V peak, or 60VDC. The isolation test voltage represents a measure of immunity to transient voltages and the part should never be used as an element of a safety isolation system. The part could be expected to function correctly with several hundred volts offset applied continuously across the isolation barrier; but then the circuitry on both sides of the barrier must be regarded as operating at an unsafe voltage and further isolation/insulation systems must form a barrier between these circuits and any user-accessible circuitry according to safety standard requirements.

REPEATED HIGH-VOLTAGE ISOLATION TESTING

It is well known that repeated high-voltage isolation testing of a barrier component can actually degrade isolation capability, to a lesser or greater degree depending on materials, construction and environment. The NMF series has toroidal isolation transformers, with no additional insulation between primary and secondary windings of enameled wire. While parts can be expected to withstand several times the stated test voltage, the isolation capability does depend on the wire insulation. Any material, including this enamel (typically polyurethane) is susceptible to eventual chemical degradation when subject to very high applied voltages thus implying that the number of tests should be strictly limited. We therefore strongly advise against repeated high voltage isolation testing, but if it is absolutely required, that the voltage be reduced by 20% from specified test voltage.

This consideration equally applies to agency recognised parts rated for better than functional isolation where the wire enamel insulation is always supplemented by a further insulation system of physical spacing or barriers.

TEMPERATURE DERATING GRAPH

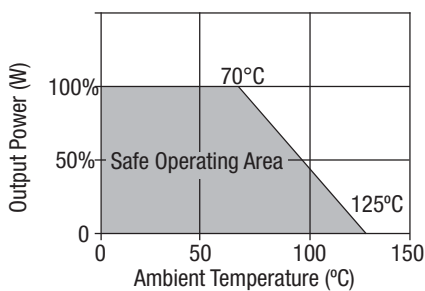

RoHS COMPLIANCE INFORMATION



This series is compatible with RoHS soldering systems with a peak wave solder temperature of 260°C for 10 seconds. The pin termination finish on the SIP package type is Tin Plate, Hot Dipped over Matte Tin over Nickel Preplate. The DIP types are Matte Tin over Nickel Preplate. Both types in this series are backward compatible with Sn/Pb soldering systems.

For further information, please visit www.murata-ps.com/rohs

PACKAGE SPECIFICATIONS

MECHANICAL DIMENSIONS

DIP package

SIP package

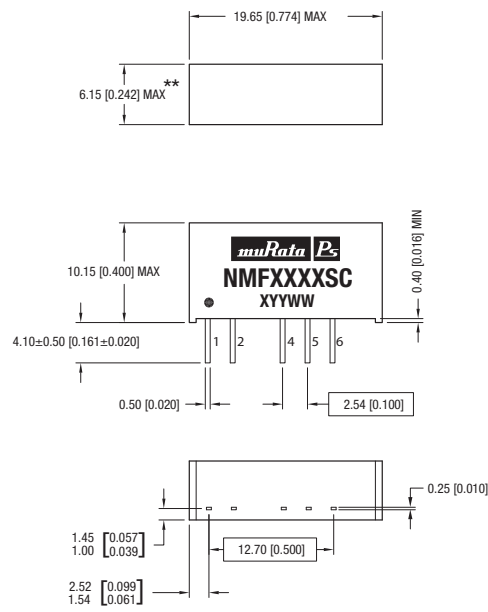
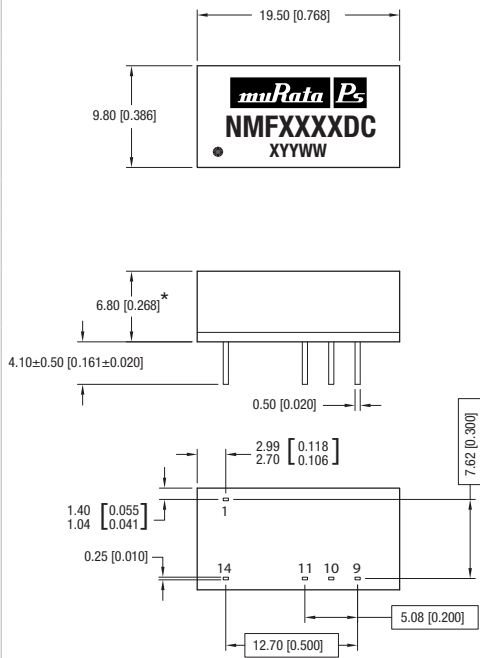

* 7.70 (0.303) for 24V & 48V variants

** 7.65 (0.301) MAX for 24V & 48V variants

Unless otherwise stated all dimensions in mm (inches) ±0.25mm (0.010"). Controlling dimension is mm. All pins on a 2.54mm (0.100") pitch and within 0.25mm (±0.010") of true position.

Weight: 2.4g (DIP) 2.1g (SIP) except for NMF24XX and NMF48XX DIP & SIP : 2.9g

PIN CONNECTIONS - 14 PIN DIP

Pin	Function
1	-VIN
9	+VOUT
10	TRIM
11	-VOUT
14	+VIN

PIN CONNECTIONS - 7 PIN SIP

Pin	Function
1	+VIN
2	-VIN
4	-VOUT
5	TRIM
6	+VOUT

PACKAGE SPECIFICATIONS (continued)

RECOMMENDED FOOTPRINT DETAILS

14 Pin DIP Package

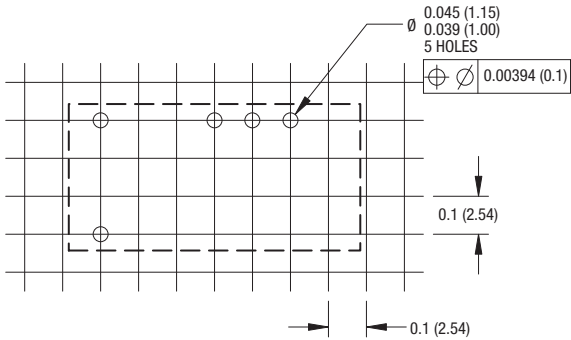

7 Pin SIP Package

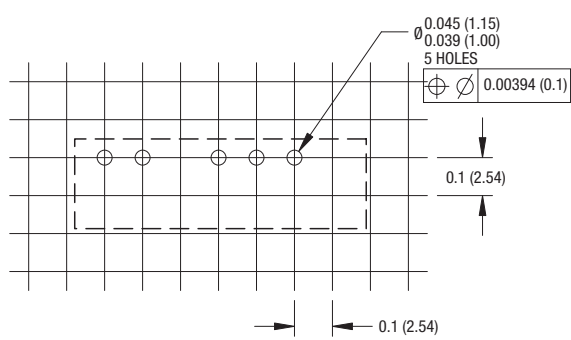

TUBE OUTLINE DIMENSIONS

14 Pin DIP Tube

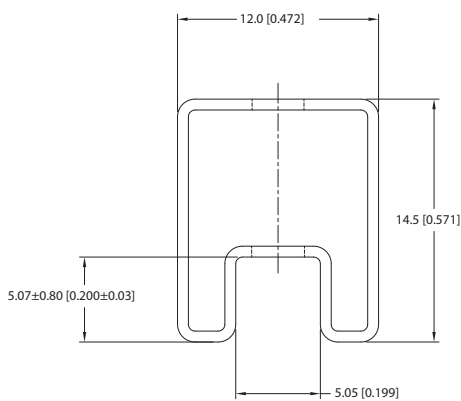

7 Pin SIP Tube

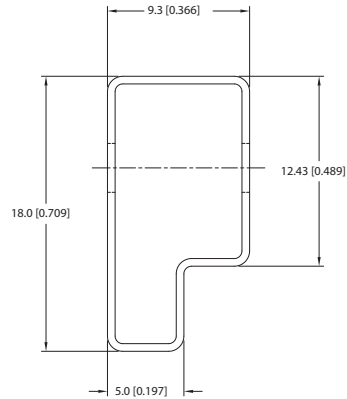

Unless otherwise specified all dimensions in mm [inches] ±0.55mm [0.022].

Tube length (14 Pin DIP) : 520mm [20.472] ±2.0 [0.079].

Tube length (7 Pin SIP) : 520mm [20.472] ±2.0 [0.079].

Tube Quantity : 25





This product is subject to the following **operating requirements** and the **Life and Safety Critical Application Sales Policy**:

Refer to: <http://www.murata-ps.com/requirements/>

Murata Power Solutions, Inc. makes no representation that the use of its products in the circuits described herein, or the use of other technical information contained herein, will not infringe upon existing or future patent rights. The descriptions contained herein do not imply the granting of licenses to make, use, or sell equipment constructed in accordance therewith. Specifications are subject to change without notice. © 2017 Murata Power Solutions, Inc.

Looking for pricing, stock, or lifecycle information?

Click below to explore more details on WIN SOURCE:

-  [View NMF0505SC on WIN SOURCE](#)
-  [Murata Power Solutions Inc. Information](#)

Optimize Your Supply Chain with WIN SOURCE Solutions

-  Global Sourcing Solution
-  Obsolete Management
-  Cost Control Management
-  Shortage Management
-  Alternative Solution
-  Excess Inventory Management