

FEATURES

- UL60950 recognised
- RoHS compliant
- Efficiency from 80%
- Power density 1.31W/cm³
- Wide temperature performance at full 2 Watt load, -40°C to 85°C
- UL 94V-0 package material
- No heatsink required
- Industry standard pinout
- 3kVDC isolation (1 minute) 'Hi Pot Test'
- 5V, 12V, 15V & 24V inputs
- 5V, 9V, 12V, & 15V output
- Fully encapsulated with toroidal magnetics
- No electrolytic or tantalum capacitors
- Pin compatible with MEV1, MEV3 & NMV series

PRODUCT OVERVIEW

The NMK series of industrial temperature range DC-DC converters, available in industry standard SIP packaging offers a power upgrade path from the 1W NMV series. The un-regulated NMK series has superior output voltage set point accuracy in conjunction with excellent load regulation for this converter type.

Unbalanced loading capabilities on dual output variants, all of the rated output power may be drawn from a single output ³.

SELECTION GUIDE

| Order Code ³ | Nominal Input Voltage | Output Voltage | Output Current | Input Current at Rated Load | Load Regulation (Typ) | Load Regulation (Max) | Ripple & Noise (Typ) ¹ | Ripple & Noise (Max) ¹ | Efficiency (Min.) | Efficiency (Typ.) | Isolation Capacitance | MTTF ² | |
|-------------------------|-----------------------|----------------|----------------|-----------------------------|-----------------------|-----------------------|-----------------------------------|-----------------------------------|-------------------|-------------------|-----------------------|-------------------|-----------|
| | V | V | mA | mA | % | % | mVp-p | mVp-p | % | % | pF | MIL. kHrs | Tel. kHrs |
| NMK0505SAC | 5 | 5 | 400 | 470 | 5.7 | 7.3 | 24 | 40 | 80 | 83 | 28 | 3998 | |
| NMK0509SAC | 5 | 9 | 222 | 455 | 4.2 | 5.9 | 20 | 25 | 83 | 86 | 36 | 3718 | |
| NMK0512SAC | 5 | 12 | 167 | 450 | 3.8 | 5.1 | 18 | 20 | 83 | 87 | 36 | 3328 | |
| NMK0515SAC | 5 | 15 | 133 | 450 | 3.4 | 4.5 | 17 | 20 | 84 | 87 | 34 | 2855 | |
| NMK1205SAC | 12 | 5 | 400 | 200 | 4.2 | 4.9 | 25 | 30 | 80 | 83 | 33 | 3532 | |
| NMK1209SAC | 12 | 9 | 222 | 190 | 2.6 | 3.1 | 19 | 20 | 83 | 87 | 53 | 2417 | |
| NMK1212SAC | 12 | 12 | 167 | 190 | 2.4 | 2.9 | 17 | 23 | 85 | 88 | 62 | 2246 | |
| NMK1215SAC | 12 | 15 | 133 | 185 | 2.0 | 2.4 | 14 | 25 | 84 | 89 | 56 | 2020 | |
| NMK1505SAC | 15 | 5 | 400 | 158 | 4.3 | 5.5 | 34 | 55 | 81 | 84 | 37 | 2202 | 9857 |
| NMK1509SAC | 15 | 9 | 222 | 153 | 3 | 4 | 21 | 40 | 83 | 86 | 51 | 2478 | 11668 |
| NMK1512SAC | 15 | 12 | 167 | 150 | 2.5 | 3.5 | 20 | 40 | 84 | 87 | 63 | 1825 | 10324 |
| NMK1515SAC | 15 | 15 | 133 | 149 | 2.4 | 3.5 | 20 | 40 | 85 | 88 | 72 | 2220 | 13067 |
| NMK2405SAC | 24 | 5 | 400 | 99 | 4.2 | 5.5 | 42 | 70 | 80 | 84 | 41 | 1618 | 9838 |
| NMK2409SAC | 24 | 9 | 222 | 95 | 2.7 | 3.5 | 30 | 55 | 83 | 87 | 59 | 2032 | 12177 |
| NMK2412SAC | 24 | 12 | 167 | 94 | 2.1 | 3 | 29 | 55 | 84 | 88 | 77 | 1879 | 12287 |
| NMK2415SAC | 24 | 15 | 133 | 93 | 2.2 | 3 | 34 | 70 | 85 | 88 | 85 | 1558 | 11155 |
| NMK0505SC | 5 | ±5 | ±200 | 470 | 5 | 6.2 | 24 | 40 | 81 | 83 | 28 | 2324 | |
| NMK0509SC | 5 | ±9 | ±111 | 455 | 3.9 | 5.3 | 18 | 30 | 83 | 86 | 33 | 2158 | |
| NMK0512SC | 5 | ±12 | ±83 | 450 | 3.7 | 4.8 | 14 | 20 | 84 | 87 | 35 | 1931 | |
| NMK0515SC | 5 | ±15 | ±67 | 450 | 3.5 | 5.2 | 12 | 20 | 84 | 87 | 31 | 1655 | |
| NMK1205SC | 12 | ±5 | ±200 | 200 | 3.4 | 3.9 | 21 | 30 | 80 | 84 | 35 | 1952 | |
| NMK1209SC | 12 | ±9 | ±111 | 190 | 2.4 | 2.8 | 16 | 20 | 83 | 87 | 50 | 2021 | |
| NMK1212SC | 12 | ±12 | ±83 | 190 | 2.2 | 2.7 | 13 | 20 | 84 | 87 | 53 | 1821 | |
| NMK1215SC | 12 | ±15 | ±67 | 190 | 1.9 | 2.4 | 13 | 20 | 83 | 87 | 57 | 1574 | |
| NMK1505SC | 15 | ±5 | ±200 | 156 | 3.7 | 5 | 27 | 50 | 81 | 84 | 43 | 1466 | 8190 |
| NMK1509SC | 15 | ±9 | ±111 | 153 | 2.4 | 3.5 | 19 | 35 | 82 | 86 | 47 | 1957 | 11117 |
| NMK1512SC | 15 | ±12 | ±83 | 151 | 2.2 | 3 | 18 | 35 | 84 | 88 | 65 | 1515 | 10279 |
| NMK1515SC | 15 | ±15 | ±67 | 150 | 2.0 | 3 | 14 | 35 | 85 | 88 | 74 | 1404 | 11747 |
| NMK2405SC | 24 | ±5 | ±200 | 96 | 3.4 | 5 | 30 | 50 | 81 | 84 | 43 | 2268 | 12558 |
| NMK2409SC | 24 | ±9 | ±111 | 94 | 2.3 | 3.5 | 26 | 45 | 84 | 87 | 65 | 2571 | 12903 |
| NMK2412SC | 24 | ±12 | ±83 | 93 | 1.9 | 3 | 24 | 45 | 85 | 89 | 82 | 2134 | 12888 |
| NMK2415SC | 24 | ±15 | ±67 | 93 | 1.7 | 3 | 17 | 35 | 85 | 89 | 86 | 1581 | 12750 |

INPUT CHARACTERISTICS

| Parameter | Conditions | Min. | Typ. | Max. | Units |
|--------------------------|--|------|------|------|--------|
| Voltage range | Continuous operation, 5V input types | 4.5 | 5 | 5.5 | V |
| | Continuous operation, 12V input types | 10.8 | 12 | 13.2 | |
| | Continuous operation, 15V input types | 13.5 | 15 | 16.5 | |
| | Continuous operation, 24V input types | 21.6 | 24 | 26.4 | |
| Reflected ripple current | NMK2405SAC, NMK2409SAC, NMK2405SC, NMK2409SC | | 14 | 25 | mA p-p |
| | All other variants | | 7.5 | 15 | |

1. See Ripple & Noise characterisation method.

2. Calculated using MIL-HDBK-217 FN2 and Telcordia SR-332 calculation model with nominal input voltage at full load.

3. See application notes on page 3.

All specifications typical at T_A=25°C, nominal input voltage and rated output current unless otherwise specified.



For full details go to www.murata-ps.com/rohs



OUTPUT CHARACTERISTICS

| Parameter | Conditions | Min. | Typ. | Max. | Units |
|----------------------------|---|------|------|------|-------|
| Rated Power | T _A =-40°C to 85°C | | | 2 | W |
| Voltage Set Point Accuracy | See tolerance envelope | | | | |
| Line regulation | High V _{IN} to low V _{IN} | | 1.05 | 1.2 | %/% |

ABSOLUTE MAXIMUM RATINGS

| | |
|---|-------|
| Lead temperature 1.5mm from case for 10 seconds | 260°C |
| Input voltage V _{IN} , NMK05 types | 7V |
| Input voltage V _{IN} , NMK12 types | 15V |
| Input voltage V _{IN} , NMK15 types | 18V |
| Input voltage V _{IN} , NMK24 types | 28V |

ISOLATION CHARACTERISTICS

| Parameter | Conditions | Min. | Typ. | Max. | Units |
|------------------------|---------------------------|------|------|------|-------|
| Isolation test voltage | Flash tested for 1 minute | 3000 | | | VDC |
| Resistance | Viso= 1000VDC | 10 | | | GΩ |

GENERAL CHARACTERISTICS

| Parameter | Conditions | Min. | Typ. | Max. | Units |
|---------------------|------------|------|------|------|-------|
| Switching frequency | | | 60 | | kHz |

TEMPERATURE CHARACTERISTICS

| Parameter | Conditions | Min. | Typ. | Max. | Units |
|--------------------------------|--|------|------|------|-------|
| Specification | All output types | -40 | | 85 | °C |
| Storage | | -50 | | 125 | |
| Case Temperature above ambient | 5V output types & NMK1509SAC (Except NMK1505S(A)C & NMK2405S(A)) | | | 28 | |
| | NMK1505S(A)C & NMK2405S(A)C | | | 32 | |
| Cooling | Free air convection | | | 25 | |

TEMPERATURE DERATING GRAPH

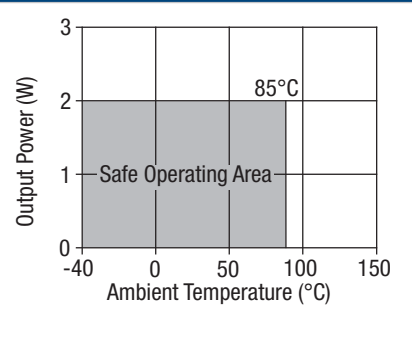

TOLERANCE ENVELOPE

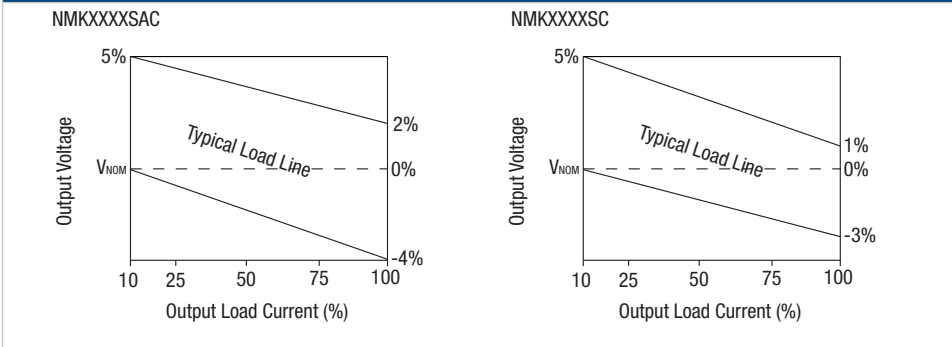

TECHNICAL NOTES

ISOLATION VOLTAGE

‘Hi Pot Test’, ‘Flash Tested’, ‘Withstand Voltage’, ‘Proof Voltage’, ‘Dielectric Withstand Voltage’ & ‘Isolation Test Voltage’ are all terms that relate to the same thing, a test voltage, applied for a specified time, across a component designed to provide electrical isolation, to verify the integrity of that isolation.

Murata Power Solutions NMK series of DC-DC converters are all 100% production tested at their stated isolation voltage. This is 3kVDC for 1 minute.

A question commonly asked is, “What is the continuous voltage that can be applied across the part in normal operation?”

The NMK series has been recognized by Underwriters Laboratory for functional insulation. Both input and output should normally be maintained within SELV limits i.e. less than 42.4V peak, or 60VDC. The isolation test voltage represents a measure of immunity to transient voltages and the part should never be used as an element of a safety isolation system. The part could be expected to function correctly with several hundred volts offset applied continuously across the isolation barrier; but then the circuitry on both sides of the barrier must be regarded as operating at an unsafe voltage and further isolation/insulation systems must form a barrier between these circuits and any user-accessible circuitry according to safety standard requirements.

REPEATED HIGH-VOLTAGE ISOLATION TESTING

It is well known that repeated high-voltage isolation testing of a barrier component can actually degrade isolation capability, to a lesser or greater degree depending on materials, construction and environment. The NMK series has toroidal isolation transformers, with no additional insulation between primary and secondary windings of enamelled wire. While parts can be expected to withstand several times the stated test voltage, the isolation capability does depend on the wire insulation. Any material, including this enamel (typically polyurethane) is susceptible to eventual chemical degradation when subject to very high applied voltages thus implying that the number of tests should be strictly limited. We therefore strongly advise against repeated high voltage isolation testing, but if it is absolutely required, that the voltage be reduced by 20% from specified test voltage.

This consideration equally applies to agency recognized parts rated for better than functional isolation where the wire enamel insulation is always supplemented by a further insulation system of physical spacing or barriers.

SAFETY APPROVAL

The NMK series has been recognised by Underwriters Laboratory (UL) to UL 60950 for functional insulation in a maximum ambient temperature of 85°C and/or case temperature limit of 130°C. Case temperature measured on the face opposite the pins. File number E151252 applies.

The NMK Series of converters are not internally fused so to meet the requirements of UL 60950 an anti-surge input line fuse should always be used as below:

- NMK05xxSC/SAC: 2A
- NMK12xxSC/SAC: 0.75A
- NMK15xxSC/SAC: 0.75A
- NMK24xxSC/SAC: 0.375A

RoHS COMPLIANT INFORMATION



This series is compatible with RoHS soldering systems with a peak wave solder temperature of 260°C for 10 seconds. The pin termination finish on the SIP package type is Tin Plate, Hot Dipped over Matte Tin with Nickel Preplate. The DIP types are Matte Tin over Nickel Preplate. Both types in this series are backward compatible with Sn/Pb soldering systems. For further information, please visit www.murata-ps.com/rohs

APPLICATION NOTES

Minimum Load

The minimum load to meet datasheet specification is 10% of the full rated load across the specified input voltage range. Lower than 10% minimum loading will result in an increase in output voltage, which may rise to typically double the specified output voltage if the output load falls to less than 5%.

Unbalanced Load

The NMK series offers unbalanced loading capabilities with up to the full 2W available from a single output. However, when operated in this mode there may be a slight performance decrease in efficiency and load regulation.

APPLICATION NOTES (continued)

Ripple & Noise Characterisation Method

All measurement to be taken with the following components connected to the UUT as detailed below.
50 Ohm coax cable, solder connections one end, BNC plug at the other end.

| | |
|-------|--|
| C1 | 1µF X7R multilayer ceramic capacitor rated at minimum 3 x the output voltage of the UUT |
| C2 | 10µF tantalum capacitor rated at minimum 1.5 x the output voltage of the UUT with ESR of less than 100 milliohms at 100 kHz e.g. AVX TPS |
| C3 | 100nF multilayer ceramic capacitor, general purpose |
| R1 | 450 Ohm resistor, carbon film, ±1% |
| R2 | 50 Ohm BNC termination |
| T1 | 3T of the coax cable through a ferrite toroid eg Ferroxcube TN32/19/13-3E25 |
| RLOAD | Resistive load at the UUT maximum rating. Connections via twisted wires. |

Differential Mode Noise Test Schematic

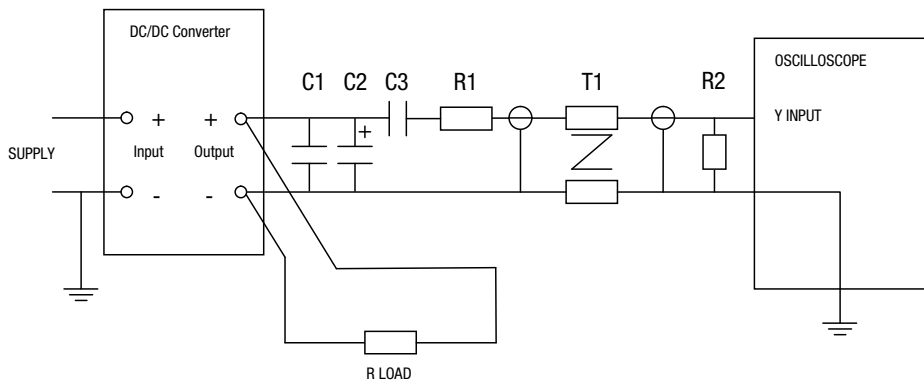

EFFICIENCY VS LOAD

NMK05XXSAC

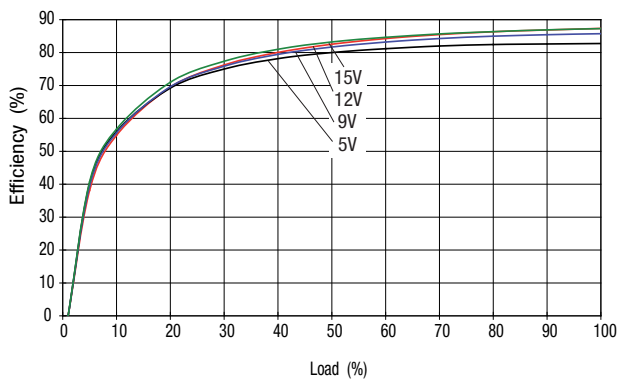

NMK12XXSAC

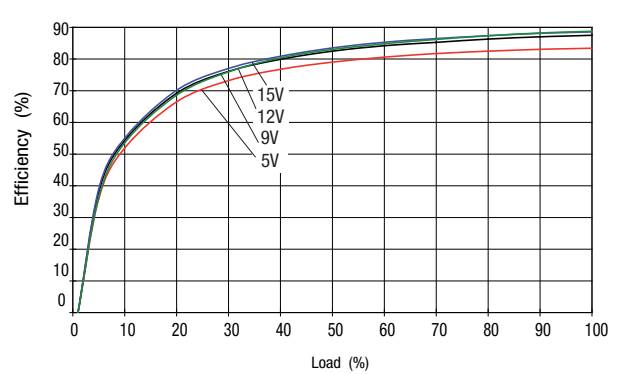

EFFICIENCY VS LOAD (continued)

NMK15XXSAC

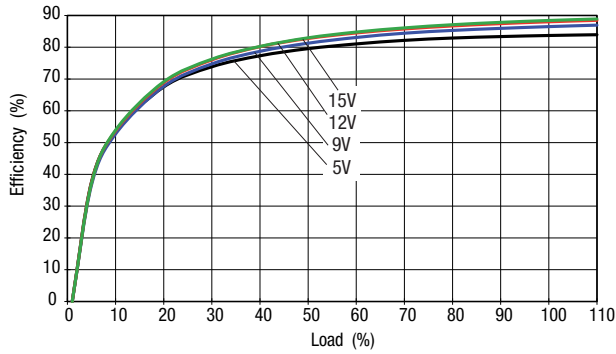

NMK24XXSAC

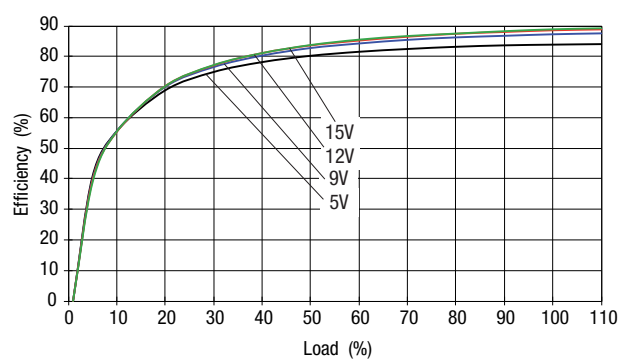

NMK05XXSC

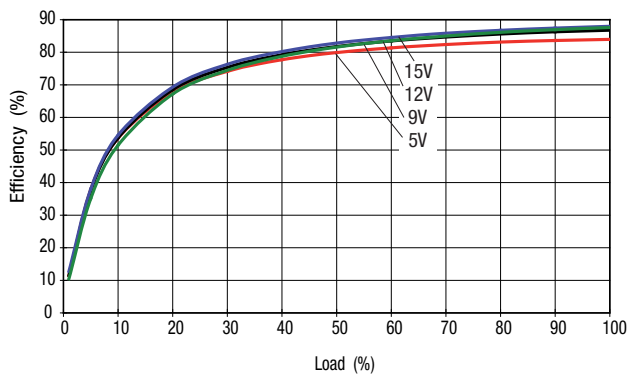

NMK12XXSC

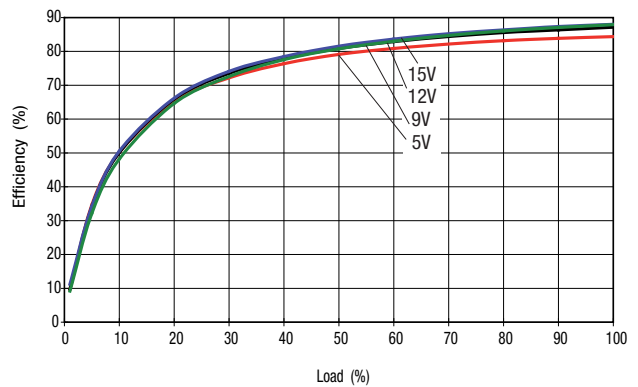

NMK15XXSC

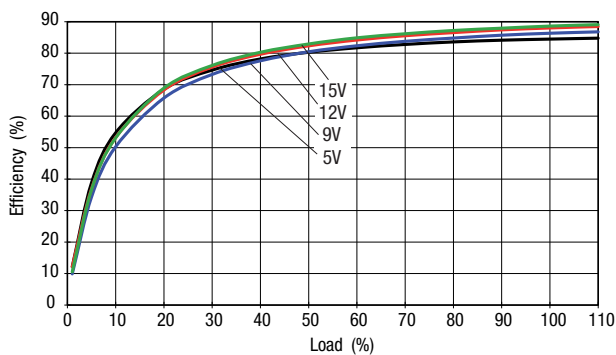

NMK24XXSC

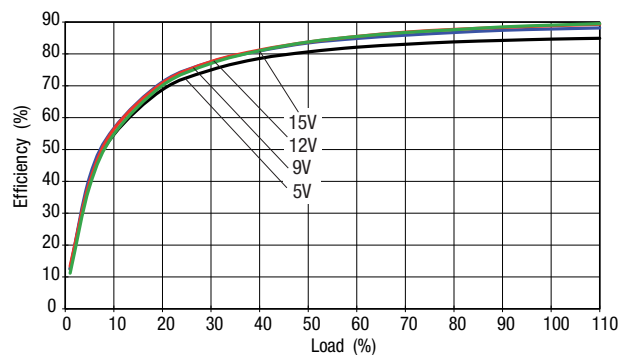

PACKAGE SPECIFICATIONS

MECHANICAL DIMENSIONS

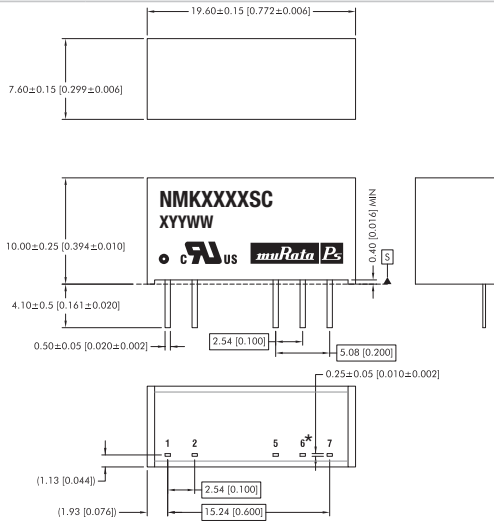

* Pin not fitted on single output variants.

All dimensions in mm (inches) Controlling dimension is mm.

All pins on a 2.54 (0.100) pitch and within ±0.1 (0.004) of true position from pin 1 at seating plane 'S'

Weight: 2.8g

PIN CONNECTIONS

| Single output variants | | Dual output variants | |
|------------------------|----------|----------------------|----------|
| Pin | Function | Pin | Function |
| 1 | +VIN | 1 | +VIN |
| 2 | -VIN | 2 | -VIN |
| 5 | -VOUT | 5 | -VOUT |
| 7 | +VOUT | 6 | OV |
| | | 7 | +VOUT |

RECOMMENDED FOOTPRINT DETAILS

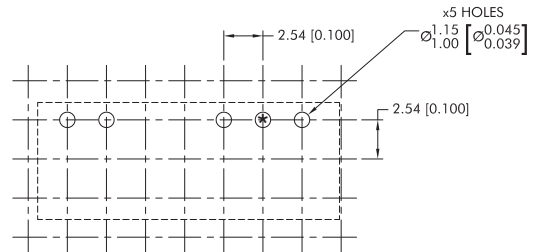

* Hole not required for single output variants.

TUBE OUTLINE DIMENSIONS

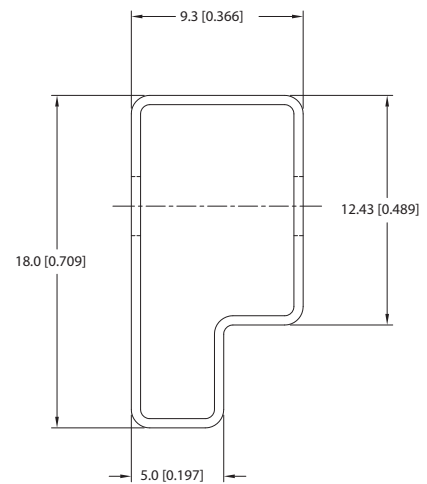

Unless otherwise stated all dimensions in mm (inches) ±0.5mm.

Tube length : 520mm ±2mm (20.47).

Tube Quantity : 25



This product is subject to the following [operating requirements](#) and the [Life and Safety Critical Application Sales Policy](#):

Refer to: <http://www.murata-ps.com/requirements/>

Murata Power Solutions, Inc. makes no representation that the use of its products in the circuits described herein, or the use of other technical information contained herein, will not infringe upon existing or future patent rights. The descriptions contained herein do not imply the granting of licenses to make, use, or sell equipment constructed in accordance therewith. Specifications are subject to change without notice. © 2018 Murata Power Solutions, Inc.

Looking for pricing, stock, or lifecycle information?

Click below to explore more details on WIN SOURCE:

- [View NMK1215SC on WIN SOURCE](#)
- [Murata Power Solutions Inc. Information](#)

Optimize Your Supply Chain with WIN SOURCE Solutions

- ✓ Global Sourcing Solution
- ✓ Obsolete Management
- ✓ Cost Control Management
- ✓ Shortage Management
- ✓ Alternative Solution
- ✓ Excess Inventory Management