

# Dual/Quad Low Noise, Precision Operational Amplifiers

## FEATURES

- Low Noise 5nV/√Hz @ 1kHz Max
- Input Offset Voltage OP-270: 75μV Max  
OP-470: 400μV Max
- Low Offset Voltage Drift OP-270: 1μV/°C Max  
OP-470: 2μV/°C Max
- Very High Gain OP-270: 1500V/mV Min  
OP-470: 1000V/mV Min
- Outstanding CMRR OP-270: 106dB Min  
OP-470: 110dB Min
- Slew Rate 3.0V/μs Typ
- Gain Bandwidth Product 6MHz Typ
- Industry Standard Pinouts

## APPLICATIONS

- Two and Three Op Amp Instrumentation Amplifiers
- Low Noise Signal Processing
- Microvolt Accuracy Threshold Detection
- Strain Gauge Amplifiers
- Accelerometer Amplifiers
- Infrared Detectors

## DESCRIPTION

The OP-270 dual and OP-470 quad are high performance op amps with 80nVp-p noise, from 0.1Hz to 10Hz, offering comparable performance to the industry standard OP-27.

The OP-270 (OP-470) feature input offset voltage below 75μV (400μV) and offset drift under 1μV/°C (2μV/°C), guaranteed over the full military temperature range. Open-loop gain of the OP-270 (OP-470) is over 1.5 million (1.0 million) into a 10kΩ load ensuring excellent gain accuracy and linearity, even in high-gain applications. Input bias current is under ±20nA (±25nA) which reduces errors due to signal source resistance. The OP-270's (OP-470's) CMRR of over 106dB (110dB) and PSRR of less than 3.2μV/V (1.8μV/V) significantly reduce errors due to ground noise and power supply fluctuations. Power consumption of the dual OP-270 (quad OP-470) is one-third less than two (four) OP-27's, a significant advantage for power conscious applications. The OP-270 and OP-470 are unity-gain stable with a gain bandwidth product of 6MHz and a slew rate of 3.0V/μs.

For applications requiring higher performance, see the LT1124 and LT1125 data sheets.

### Strain Gauge Signal Conditioner with Bridge Excitation

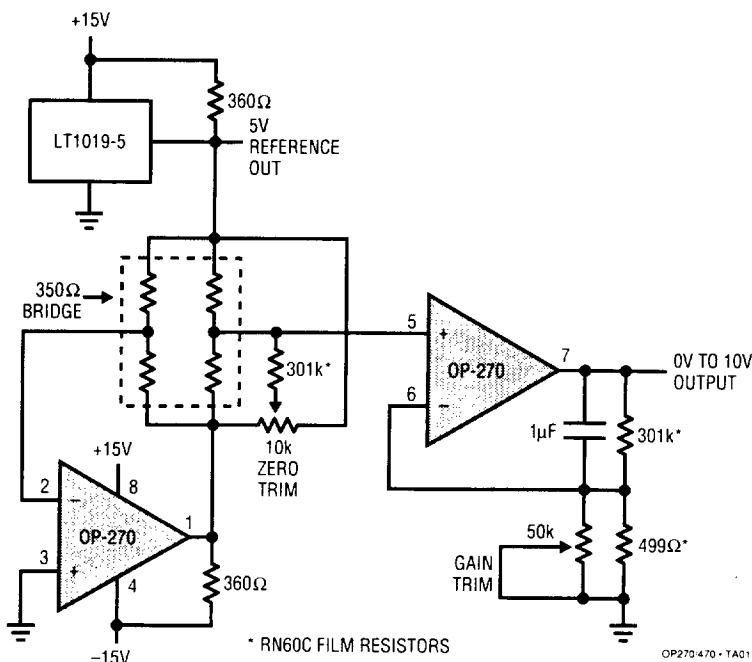

### 0.1Hz to 10Hz Voltage Noise

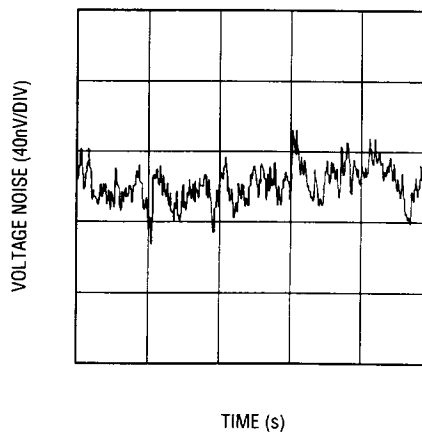

**ABSOLUTE MAXIMUM RATINGS**

Supply Voltage .....	±18V
Differential Input Voltage (Note 4) .....	±1.0V
Differential Input Current (Note 4) .....	±25mA
Input Voltages .....	Equal to Supply Voltages
Output Short Circuit Duration .....	Indefinite

Operating Temperature Range

OP270A/OP470A .....	-55°C to 125°C
OP270E/OP470E .....	
OP270G/OP470G .....	-40°C to 85°C
Storage Temperature Range	
All Grades .....	-65°C to 150°C
Lead Temperature (Soldering, 10 sec.) .....	300°C

**PACKAGE/ORDER INFORMATION**

<p>J8 PACKAGE 8-LEAD CERAMIC DIP N8 PACKAGE 8-LEAD PLASTIC DIP OP270/470 - PO103</p>	<p>J PACKAGE 14-LEAD CERAMIC DIP N PACKAGE 14-LEAD PLASTIC DIP OP270/470 - PO102</p>	<p>S PACKAGE 16-LEAD PLASTIC SOL OP270/470 - PO101</p>
<p>ORDER PART NUMBER</p>	<p>ORDER PART NUMBER</p>	<p>ORDER PART NUMBER</p>
<p>OP-270AJ8 OP-270EJ8 OP-270GN8</p>	<p>OP-470AJ OP-470EJ OP-470GN</p>	<p>OP-470GS</p>

2

**ELECTRICAL CHARACTERISTICS**  $V_S = \pm 15V$ ,  $T_A = 25^\circ C$ , unless otherwise noted.

SYMBOL	PARAMETER	CONDITIONS	OP-270A/E			OP-470A/E			OP-270G OP-470G			UNITS	
			MIN	TYP	MAX	MIN	TYP	MAX	MIN	TYP	MAX		
$V_{OS}$	Input Offset Voltage	OP-270 OP-470		10	75				50	250		$\mu V$	
$I_{OS}$	Input Offset Current	OP-270 $V_{CM} = 0V$ OP-470 $V_{CM} = 0V$		5	15		100	400	6	20	400	1000	$\mu V$
$I_B$	Input Bias Current	$V_{CM} = 0V$		±7	±20		±7	±25	±15	±60			nA
$e_n$ p-p	Input Noise Voltage	0.1Hz to 10Hz (Note 1)		80	200		80	200	80	200			nVp-p
$e_n$	Input Noise Voltage Density	$f_0 = 10Hz$ (Note 2) $f_0 = 100Hz$ (Note 2) $f_0 = 1000Hz$ (Note 2)		3.6	6.5		3.6	6.5	3.6	6.5			nV/ $\sqrt{Hz}$
				3.2	5.5		3.2	5.5	3.2	5.5			nV/ $\sqrt{Hz}$
				3.2	5.0		3.2	5.0	3.2	5.0			nV/ $\sqrt{Hz}$

# OP-270/OP-470

## ELECTRICAL CHARACTERISTICS $V_S = \pm 15V$ , $T_A = 25^\circ C$ , unless otherwise noted.

SYMBOL	PARAMETER	CONDITIONS	OP-270A/E			OP-470A/E			OP-270G OP-470G			UNITS
			MIN	TYP	MAX	MIN	TYP	MAX	MIN	TYP	MAX	
$i_n$	Input Noise Current Density	$f_0 = 10\text{Hz}$		1.5		1.5		1.5		$\text{pA}/\sqrt{\text{Hz}}$		
		$f_0 = 100\text{Hz}$		0.5		0.5		0.5		$\text{pA}/\sqrt{\text{Hz}}$		
		$f_0 = 1000\text{Hz}$		0.4		0.4		0.4		$\text{pA}/\sqrt{\text{Hz}}$		
$A_{VOL}$	Large Signal Voltage Gain	$V_{OUT} = \pm 10V$ , $R_L = 10k\Omega$	1500	5000		1000	5000		800	2000	V/mV	
		$V_{OUT} = \pm 10V$ , $R_L = 2k\Omega$	750	2000		500	2000		400	1000	V/mV	
$V_{CM}$	Input Voltage Range	(Note 3)	$\pm 12$	$\pm 12.5$		$\pm 12$	$\pm 12.5$		$\pm 12$	$\pm 12.5$	V	
$V_{OUT}$	Output Voltage Swing	$R_L \geq 2k\Omega$	$\pm 12$	$\pm 13.5$		$\pm 12$	$\pm 13.5$		$\pm 12$	$\pm 13.5$	V	
CMRR	Common Mode Rejection Ratio	$V_{CM} = \pm 12V$	106	125		110	125		100	120	dB	
PSRR	Power Supply Rejection Ratio	$V_S = \pm 4.5V$ to $\pm 18V$		0.56	3.2		0.56	1.8		1.0	5.6	$\mu V/V$
SR	Slew Rate		1.7	3.0		1.7	3.0		1.7	3.0	V/ $\mu s$	
$I_S$	Supply Current	OP-270 No Load		4.5	6.5					4.0	6.5	mA
		OP-470 No Load					9.0	11.0		9.0	11.0	mA
GBW	Gain Bandwidth Product	$A_V = +10$		6			6			6	MHz	
CS	Channel Separation	$V_{OUT} = 20V_{p-p}$ , $f_0 = 10\text{Hz}$ (Note 1)	125	175		125	175		125	175	dB	
$C_{IN}$	Input Capacitance			3			3			3	pF	

## ELECTRICAL CHARACTERISTICS $V_S = \pm 15V$ , $-55^\circ C \leq T_A \leq 125^\circ C$ , unless otherwise noted.

SYMBOL	PARAMETER	CONDITIONS		OP-270A			OP-470A			UNITS
				MIN	TYP	MAX	MIN	TYP	MAX	
$V_{OS}$	Input Offset Voltage		●	30	175		140	600	$\mu V$	
$\frac{\Delta V_{OS}}{\Delta \text{Temp}}$	Average Input Offset Voltage Drift		●	0.2	1.0		0.4	2.0	$\mu V/^\circ C$	
$I_{OS}$	Input Offset Current	$V_{CM} = 0V$	●	10	45		10	55	nA	
$I_B$	Input Bias Current	$V_{CM} = 0V$	●	$\pm 15$	$\pm 60$		$\pm 15$	$\pm 50$	nA	
$A_{VOL}$	Large Signal Voltage Gain	$R_L \geq 10k\Omega$ , $V_{OUT} = \pm 10V$	●	750	3000		750	3000	V/mV	
		$R_L \geq 2k\Omega$ , $V_{OUT} = \pm 10V$	●	400	1500		400	1500	V/mV	
$V_{CM}$	Input Voltage Range	(Note 3)	●	$\pm 11$	$\pm 12$		$\pm 11$	$\pm 12$	V	
$V_{OUT}$	Output Voltage Swing	$R_L \geq 2k\Omega$	●	$\pm 12$	$\pm 13$		$\pm 12$	$\pm 13$	V	
CMRR	Common Mode Rejection Ratio	$V_{CM} = \pm 11V$	●	100	120		100	120	dB	
PSRR	Power Supply Rejection Ratio	$V_S = \pm 4.5V$ to $\pm 18V$	●	1.0	5.6		1.0	5.6	$\mu V/V$	
$I_S$	Supply Current All Amplifiers	No Load	●	5.0	7.5		10	13	mA	

The ● denotes the specifications which apply over the full operating temperature range.

**Note 1:** This parameter is guaranteed but not 100% tested.

**Note 2:** This parameter is sample tested only.

**Note 3:** This parameter is guaranteed by the CMRR test.

**Note 4:** The inputs are protected by back-to-back diodes. Current limiting resistors are not used in order to achieve low noise. If differential input voltage exceeds  $\pm 1.4V$ , the input current should be limited to 25mA.

**ELECTRICAL CHARACTERISTICS**  $V_S = \pm 15V, -40^\circ C \leq T_A \leq 85^\circ C$ , unless otherwise noted.

SYMBOL	PARAMETER	CONDITIONS	OP-270E			OP-470E		OP-270G OP-470G		UNITS
			MIN	TYP	MAX	MIN	TYP	MAX	MIN	
$V_{OS}$	Input Offset Voltage	OP-270	●	25	150			100	400	$\mu V$
		OP-470	●			120	500	500	1500	$\mu V$
$\frac{\Delta V_{OS}}{\Delta Temp}$	Average Input Offset Voltage Drift	OP-270	●	0.2	1.0			0.7	3.0	$\mu V/^\circ C$
		OP-470	●			0.4	2.0	2.0		$\mu V/^\circ C$
$I_{OS}$	Input Offset Current	$V_{CM} = 0V$	●	15	30	17	20	17	50	nA
$I_B$	Input Bias Current	$V_{CM} = 0V$	●	$\pm 15$	$\pm 60$	$\pm 17$	$\pm 50$	$\pm 18$	$\pm 75$	nA
$A_{VOL}$	Large Signal Voltage Gain	$V_{OUT} = \pm 10V, R_L \geq 10k\Omega$	●	1000	2000	800	2000	600	1500	V/mV
		$V_{OUT} = \pm 10V, R_L \geq 2k\Omega$	●	500	1000	400	1000	300	800	V/mV
$V_{CM}$	Input Voltage Range	(Note 3)	●	$\pm 11$	$\pm 12$	$\pm 11$	$\pm 12$	$\pm 11$	$\pm 12$	V
$V_{OUT}$	Output Voltage Swing	$R_L \geq 2k\Omega$	●	$\pm 12$	$\pm 13$	$\pm 12$	$\pm 13$	$\pm 12$	$\pm 13$	V
CMRR	Common Mode Rejection Ratio	$V_{CM} = \pm 11V$	●	100	120	100	120	90	110	dB
PSRR	Power Supply Rejection Ratio	$V_S = \pm 4.5V$ to $\pm 18V$	●	0.7	5.6	0.7	5.6	1.8	10	$\mu V/V$
$I_S$	Supply Current All Amplifiers	OP-270 No Load	●	4.8	7.2			4.8	7.2	mA
		OP-470 No Load	●			9.6	13	9.6	13	mA

2

**TYPICAL PERFORMANCE CHARACTERISTICS**

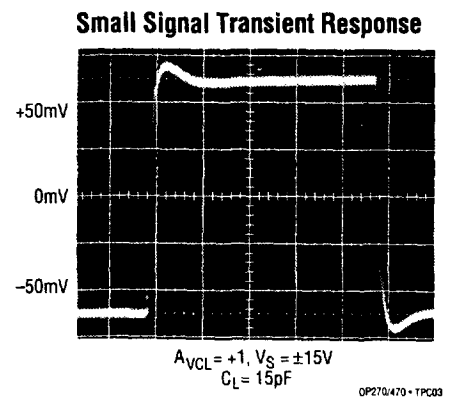
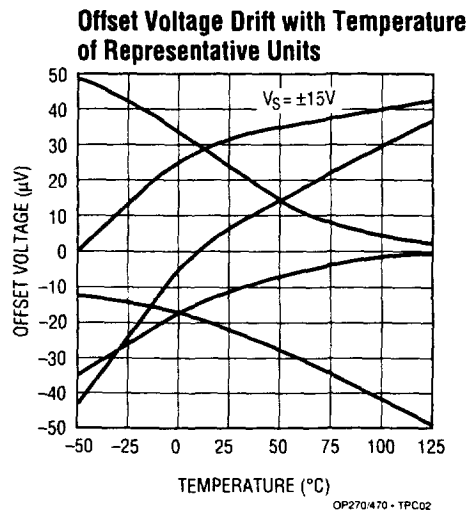
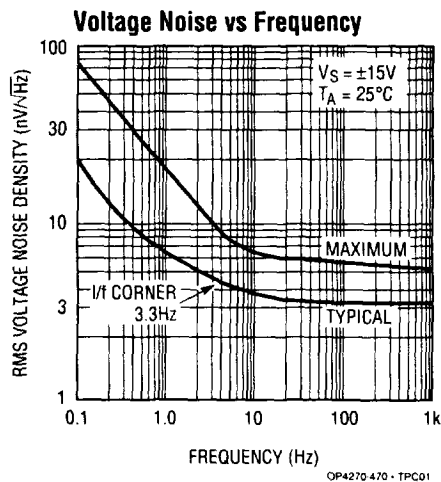



## Looking for pricing, stock, or lifecycle information?

Click below to explore more details on WIN SOURCE:

 [View OP270GN8#PBF on WIN SOURCE](#)

 [Linear Technology](#) Information

## Optimize Your Supply Chain with WIN SOURCE Solutions

-  Global Sourcing Solution
-  Obsolete Management
-  Cost Control Management
-  Shortage Management
-  Alternative Solution
-  Excess Inventory Management