



**THE DATASHEET OF
ALBCBS3530A**



New from Amphenol

Introducing the NEW QuickSNAP™ Lightning Bushing

INTRODUCING
The NEW QuickSNAP™ Lightning Bushing

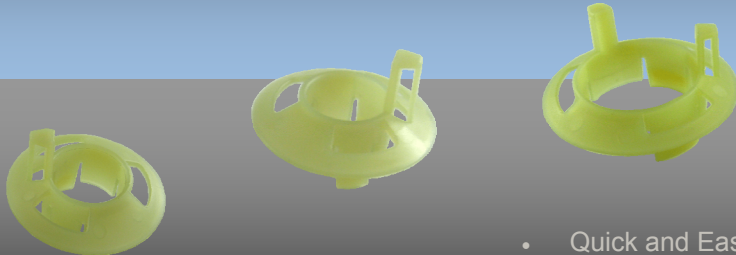

- Quick and Easy Installation.
- Reduces FOD.
- Lightweight.

Other System Attachments



High Performance Clamps



Anchor Supports

Amphenol has over 30 years experience in System Attachment technology, serving the Aerospace, Military, Industrial and extreme environment markets. The company produces high quality products and prides itself on timely and accurate delivery.

Designed to help guide wired bundles through airframe stringers and frames, Amphenol's QuickSNAP™ Lightning Bushings were designed with lean manufacturing in mind. Unlike traditional lightning bushings, our products, whether it's our one-piece design or two-piece design, significantly reduce installation times and reduce the amount of FOD on the aircraft. The lightweight QuickSNAP's are made with smooth edges in order to reduce wire chaffing, and although they are available in various standard configurations and sizes, we offer custom-made product as well.

Traditional Lightning Bushing

15 MINUTES to INSTALL!

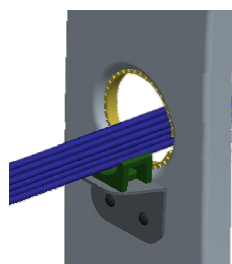

Six Part Installation

3 rivets	1 nylon part
1 caterpillar	1 sheet metal part

Amphenol's QuickSNAP Lightning Bushing

15 SECONDS to INSTALL!

A better way!

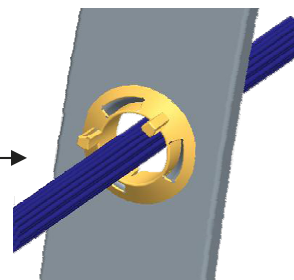

One Part Installation

1 Amphenol QuickSNAP Lightning Bushing

Features & Benefits

- Snap-In design makes it quick and easy to install—no tools are required
- No glue or other hardware is necessary—reduces FOD!
- Made of lightweight material
- Smooth edges reduces wire chaffing
- Offered in two different designs: one piece or two pieces
- Custom variations are available upon request

Additional Information

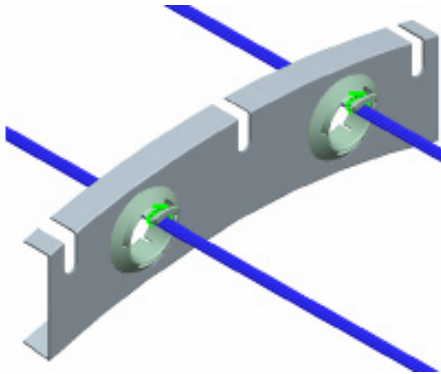

Depending upon what your requirements are, Amphenol can accommodate your needs.

Simply provide the hole diameter and frame thickness, and we'll take care of the rest.

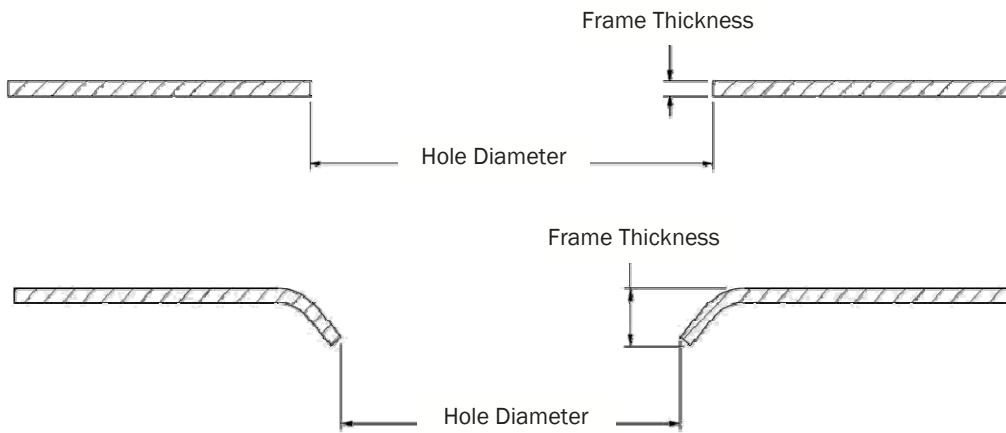

CUSTOMIZATION LIGHTENING BUSHING

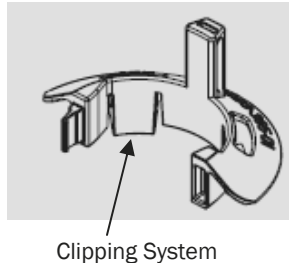
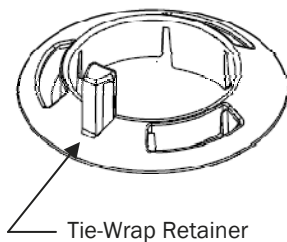

TECHNICAL SPECIFICATIONS	
Material	Polyamide 6/6 (Nylon)
Temperature Range	-55°C to 150°C
Flamability	FAR 25.853
Density	0.041185 lbs/in ³

Product Customization

Amphenol AirLB NA welcomes inquiries for application-specific modifications to our QuickSNAP Lightening Bushings. Our products are continuously expanding to meet current and future customer needs.

Related Amphenol Products



JB™ Jig Board Clamps



Frame & Stringer Clip-On Supports

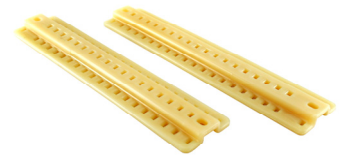

Raceways

Contact Information

Amphenol AirLB NA

3335 1ere Rue
St-Hubert, Qc. J3Y 8Y6 Canada
email: info@amphenol-airlb.com
Tel: 450-445-6007

Looking for pricing, stock, or lifecycle information?

Click below to explore more details on WIN SOURCE:

 [View ALBCBS3530A on WIN SOURCE](#)

 [Amphenol PCD Information](#)

Optimize Your Supply Chain with WIN SOURCE Solutions

-  Global Sourcing Solution
-  Obsolete Management
-  Cost Control Management
-  Shortage Management
-  Alternative Solution
-  Excess Inventory Management