



**THE DATASHEET OF  
SI7810DN-T1-GE3**



## N-Channel 100-V (D-S) MOSFET

PRODUCT SUMMARY		
$V_{DS}$ (V)	$R_{DS(on)}$ ( $\Omega$ )	$I_D$ (A)
100	0.062 at $V_{GS} = 10$ V	5.4
	0.084 at $V_{GS} = 6$ V	4.6

### FEATURES

- Halogen-free Option Available
- TrenchFET<sup>®</sup> Power MOSFET
- New Low Thermal Resistance
- PowerPAK<sup>®</sup> 1212-8 Package with Low 1.07 mm Profile
- PWM Optimized



**RoHS**  
COMPLIANT

### APPLICATIONS

- Primary Side Switch
- In-Rush Current Limiter

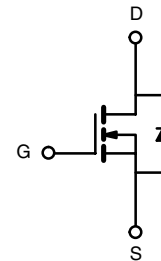
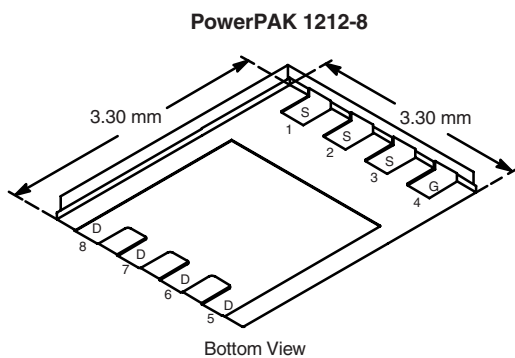

N-Channel MOSFET

**Ordering Information:** Si7810DN-T1-E3 (Lead (Pb)-free)  
Si7810DN-T1-GE3 (Lead (Pb)-free and Halogen-free)

ABSOLUTE MAXIMUM RATINGS $T_A = 25$ °C, unless otherwise noted					
Parameter	Symbol	10 s	Steady State	Unit	
Drain-Source Voltage	$V_{DS}$	100		V	
Gate-Source Voltage	$V_{GS}$	$\pm 20$			
Continuous Drain Current ( $T_J = 150$ °C) <sup>a</sup>	$I_D$	$T_A = 25$ °C	5.4	3.4	A
		$T_A = 70$ °C	4.3	2.8	
Pulsed Drain Current	$I_{DM}$	20			
Continuous Source Current (Diode Conduction) <sup>a</sup>	$I_S$	3.2	1.3	A	
Single Avalanche Current	$I_{AS}$	19			
Single Avalanche Energy (Duty Cycle 1 %)		$E_{AS}$	18		
Maximum Power Dissipation <sup>a</sup>	$P_D$	$T_A = 25$ °C	3.8	1.5	W
		$T_A = 70$ °C	2.0	0.8	
Operating Junction and Storage Temperature Range	$T_J, T_{stg}$	- 55 to 150		°C	
Soldering Recommendations <sup>b,c</sup>		260			

THERMAL RESISTANCE RATINGS					
Parameter		Symbol	Typical	Maximum	Unit
Maximum Junction-to-Ambient <sup>a</sup>	$t \leq 10$ s	$R_{thJA}$	26	33	°C/W
	Steady State		65	81	
Maximum Junction-to-Case (Drain)	Steady State	$R_{thJC}$	1.9	2.4	

Notes:

- Surface Mounted on 1" x 1" FR4 board.
- See Solder Profile (<http://www.vishay.com/ppg?73257>). The PowerPAK 1212-8 is a leadless package. The end of the lead terminal is exposed copper (not plated) as a result of the singulation process in manufacturing. A solder fillet at the exposed copper tip cannot be guaranteed and is not required to ensure adequate bottom side solder interconnection.
- Rework Conditions: manual soldering with a soldering iron is not recommended for leadless components.

<b>SPECIFICATIONS</b> $T_J = 25\text{ }^\circ\text{C}$ , unless otherwise noted						
Parameter	Symbol	Test Conditions	Min.	Typ.	Max.	Unit
<b>Static</b>						
Gate Threshold Voltage	$V_{GS(th)}$	$V_{DS} = V_{GS}, I_D = 250\text{ }\mu\text{A}$	2		4.5	V
Gate-Body Leakage	$I_{GSS}$	$V_{DS} = 0\text{ V}, V_{GS} = \pm 20\text{ V}$			$\pm 100$	nA
Zero Gate Voltage Drain Current	$I_{DSS}$	$V_{DS} = 100\text{ V}, V_{GS} = 0\text{ V}$			1	$\mu\text{A}$
		$V_{DS} = 100\text{ V}, V_{GS} = 0\text{ V}, T_J = 55\text{ }^\circ\text{C}$			5	
On-State Drain Current <sup>a</sup>	$I_{D(on)}$	$V_{DS} \geq 5\text{ V}, V_{GS} = 10\text{ V}$	20			A
Drain-Source On-State Resistance <sup>a</sup>	$R_{DS(on)}$	$V_{GS} = 10\text{ V}, I_D = 5.4\text{ A}$		0.052	0.062	$\Omega$
		$V_{GS} = 6\text{ V}, I_D = 4.6\text{ A}$		0.070	0.084	
Forward Transconductance <sup>a</sup>	$g_{fs}$	$V_{DS} = 15\text{ V}, I_D = 5.4\text{ A}$		12		S
Diode Forward Voltage <sup>a</sup>	$V_{SD}$	$I_S = 3.2\text{ A}, V_{GS} = 0\text{ V}$		0.78	1.2	V
<b>Dynamic<sup>b</sup></b>						
Total Gate Charge	$Q_g$	$V_{DS} = 50\text{ V}, V_{GS} = 10\text{ V}, I_D = 5.4\text{ A}$		13.5	17	nC
Gate-Source Charge	$Q_{gs}$			3		
Gate-Drain Charge	$Q_{gd}$			4.6		
Turn-On Delay Time	$t_{d(on)}$	$V_{DD} = 50\text{ V}, R_L = 50\text{ }\Omega$ $I_D \equiv 1\text{ A}, V_{GEN} = 10\text{ V}, R_G = 6\text{ }\Omega$		10	15	ns
Rise Time	$t_r$			15	25	
Turn-Off Delay Time	$t_{d(off)}$			20	30	
Fall Time	$t_f$			15	25	
Source-Drain Reverse Recovery Time	$t_{rr}$	$I_F = 3.2\text{ A}, di/dt = 100\text{ A}/\mu\text{s}$		45	90	

Notes:

- a. Pulse test; pulse width  $\leq 300\text{ }\mu\text{s}$ , duty cycle  $\leq 2\%$ .
- b. Guaranteed by design, not subject to production testing.

Stresses beyond those listed under "Absolute Maximum Ratings" may cause permanent damage to the device. These are stress ratings only, and functional operation of the device at these or any other conditions beyond those indicated in the operational sections of the specifications is not implied. Exposure to absolute maximum rating conditions for extended periods may affect device reliability.

## TYPICAL CHARACTERISTICS $T_A = 25\text{ }^\circ\text{C}$ , unless otherwise noted

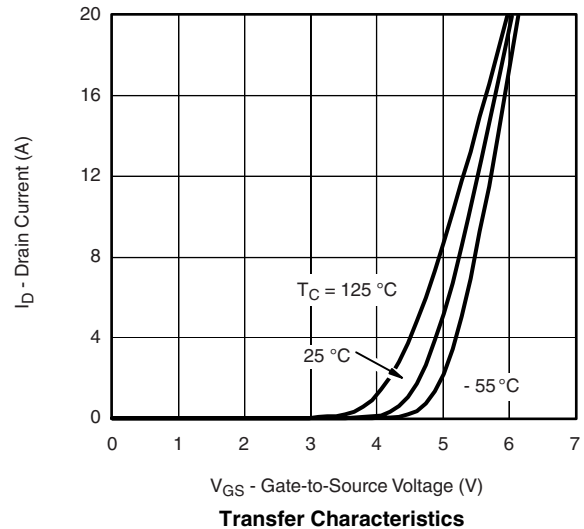
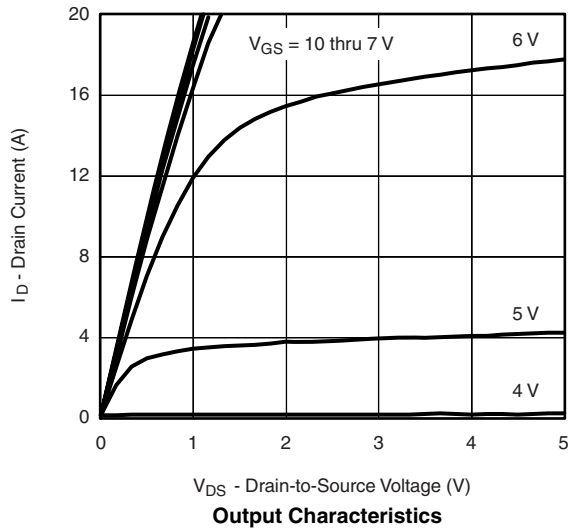

**TYPICAL CHARACTERISTICS**  $T_A = 25^\circ\text{C}$ , unless otherwise noted

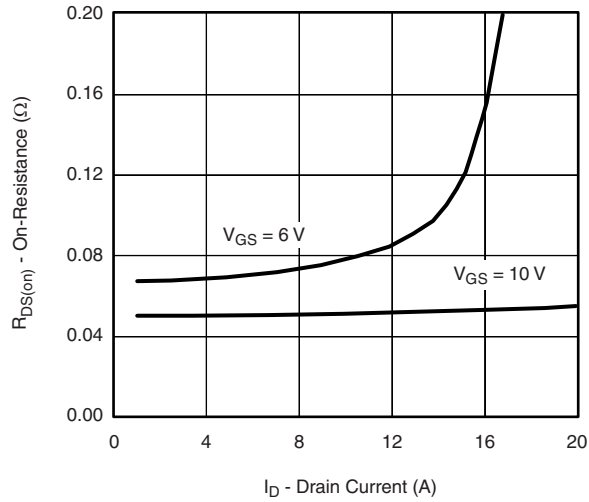

**On-Resistance vs. Drain Current**

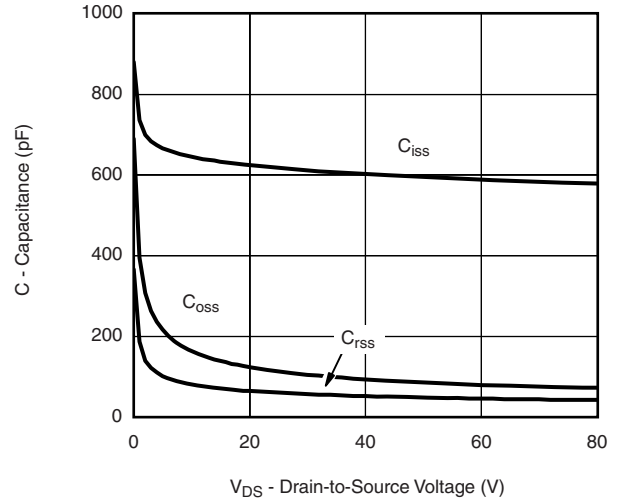

**Capacitance**

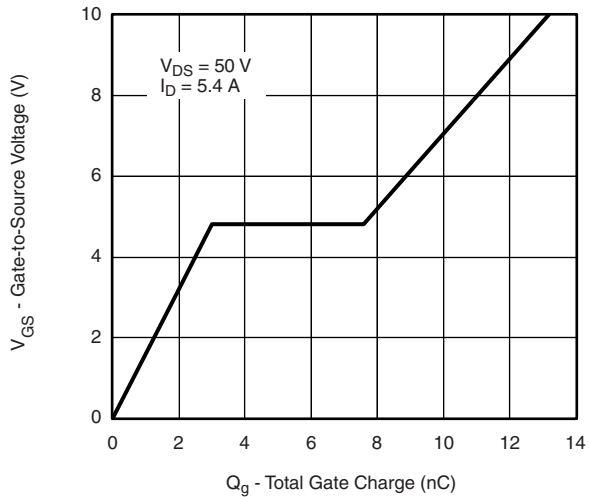

**Gate Charge**

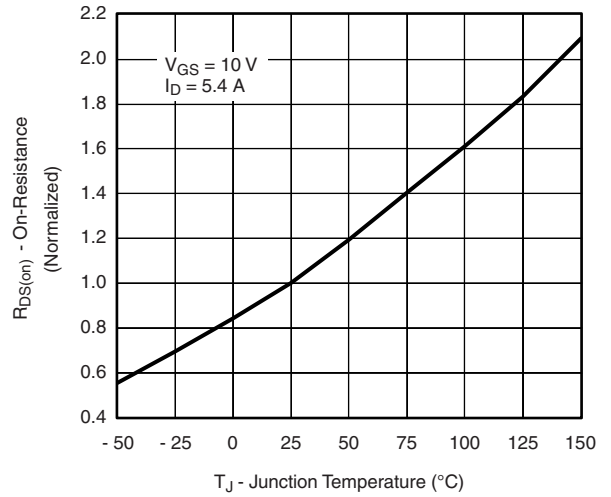

**On-Resistance vs. Junction Temperature**

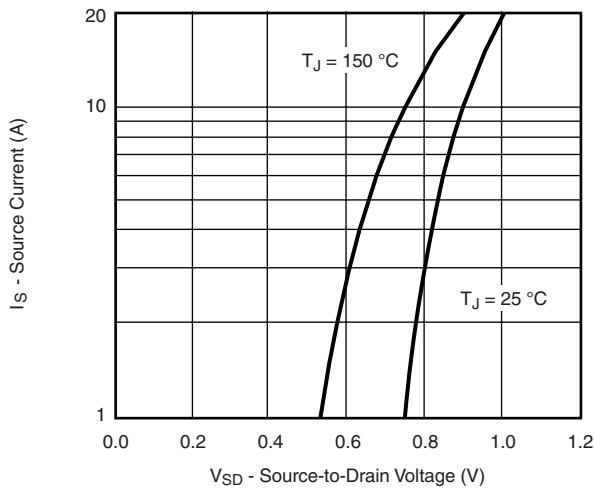

**Source-Drain Diode Forward Voltage**

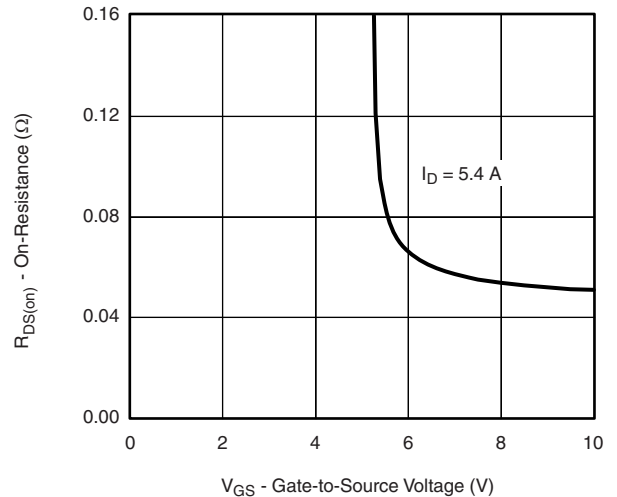

**On-Resistance vs. Gate-to-Source Voltage**

**TYPICAL CHARACTERISTICS**  $T_A = 25^\circ\text{C}$ , unless otherwise noted

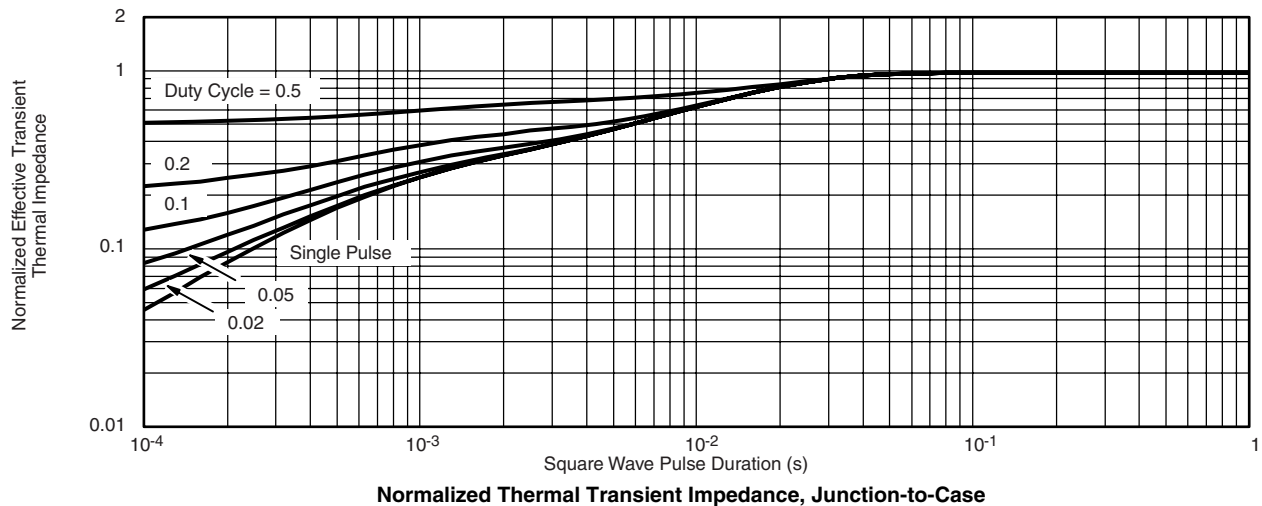
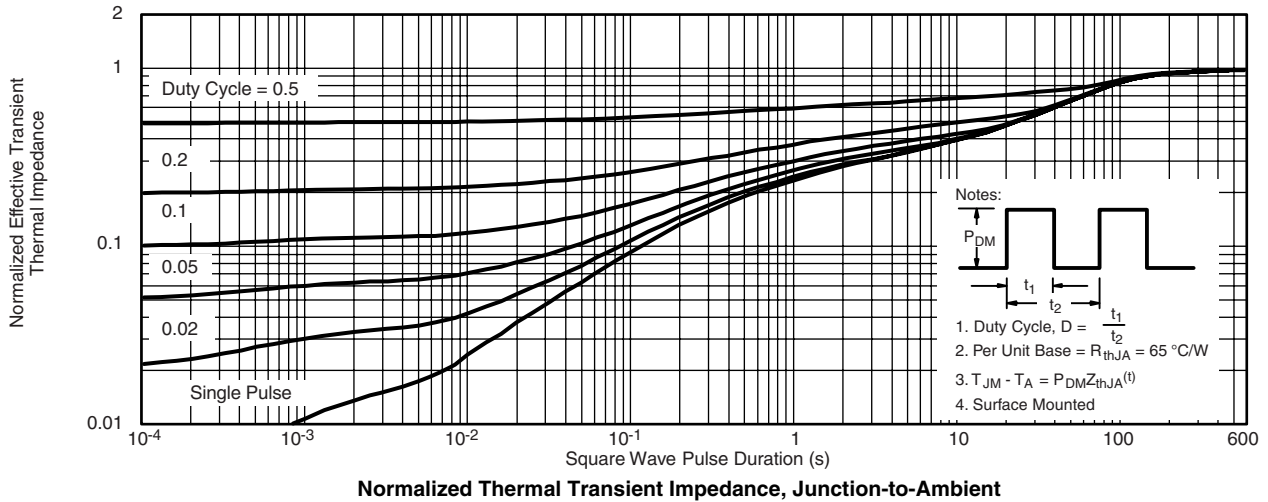
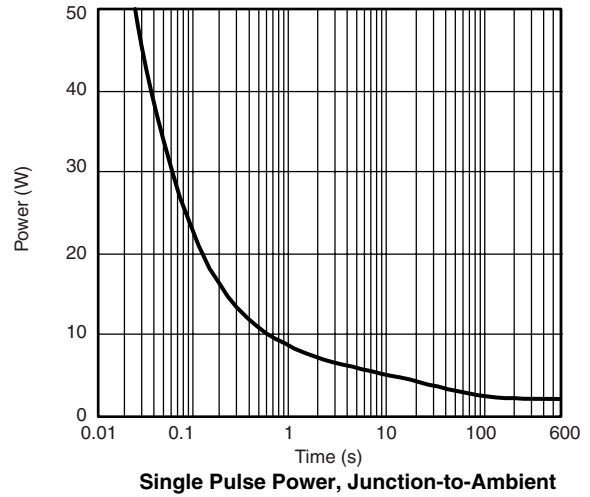
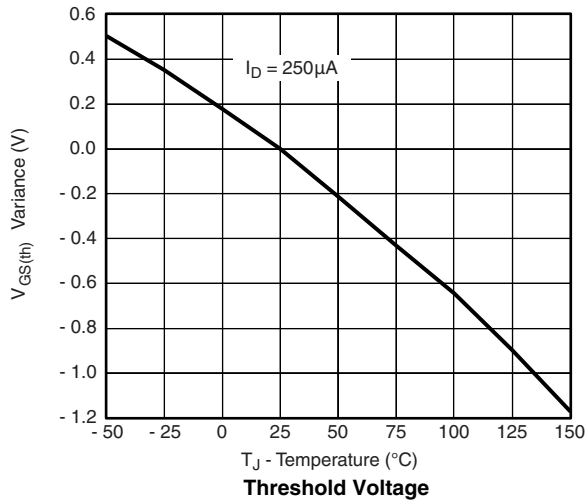

Vishay Siliconix maintains worldwide manufacturing capability. Products may be manufactured at one of several qualified locations. Reliability data for Silicon Technology and Package Reliability represent a composite of all qualified locations. For related documents such as package/tape drawings, part marking, and reliability data, see <http://www.vishay.com/ppg70689>.



## Disclaimer

All product specifications and data are subject to change without notice.

Vishay Intertechnology, Inc., its affiliates, agents, and employees, and all persons acting on its or their behalf (collectively, "Vishay"), disclaim any and all liability for any errors, inaccuracies or incompleteness contained herein or in any other disclosure relating to any product.

Vishay disclaims any and all liability arising out of the use or application of any product described herein or of any information provided herein to the maximum extent permitted by law. The product specifications do not expand or otherwise modify Vishay's terms and conditions of purchase, including but not limited to the warranty expressed therein, which apply to these products.

No license, express or implied, by estoppel or otherwise, to any intellectual property rights is granted by this document or by any conduct of Vishay.

The products shown herein are not designed for use in medical, life-saving, or life-sustaining applications unless otherwise expressly indicated. Customers using or selling Vishay products not expressly indicated for use in such applications do so entirely at their own risk and agree to fully indemnify Vishay for any damages arising or resulting from such use or sale. Please contact authorized Vishay personnel to obtain written terms and conditions regarding products designed for such applications.

Product names and markings noted herein may be trademarks of their respective owners.

## Looking for pricing, stock, or lifecycle information?

Click below to explore more details on WIN SOURCE:

 [View SI7810DN-T1-GE3 on WIN SOURCE](#)

 [Vishay Information](#)

## Optimize Your Supply Chain with WIN SOURCE Solutions

-  Global Sourcing Solution
-  Obsolete Management
-  Cost Control Management
-  Shortage Management
-  Alternative Solution
-  Excess Inventory Management