



**THE DATASHEET OF  
TLE4270SNKSA1**



## Features

- Output voltage tolerance  $\leq \pm 2\%$
- 650 mA output current capability
- Low-drop voltage
- Reset functionality
- Adjustable reset time
- Suitable for use in automotive electronics
- Integrated overtemperature protection
- Reverse polarity protection
- Input voltage up to 42 V
- Overvoltage protection up to 65 V ( $\leq 400$  ms)
- Short-circuit proof
- Wide temperature range
- ESD protection  $> 4000$  V

## Functional Description

This device is a 5-V low drop fixed-voltage regulator. The maximum input voltage is 42 V (65 V,  $\leq 400$  ms). Up to an input voltage of 26 V and for an output current up to 650 mA it regulates the output voltage within a 2% accuracy. The short circuit protection limits the output current of more than 650 mA. The device incorporates overvoltage protection and a temperature protection which turns off the device at high temperatures.

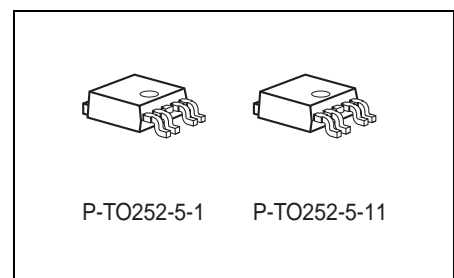
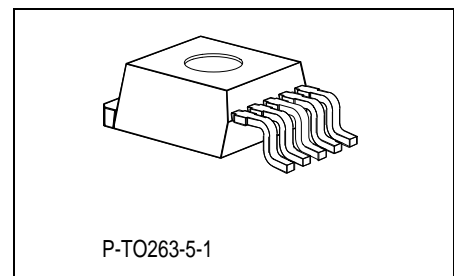
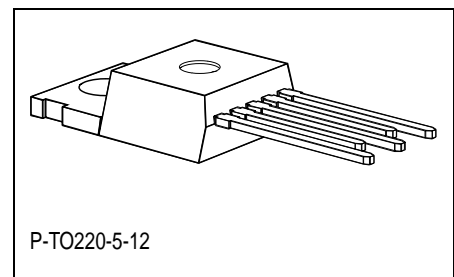
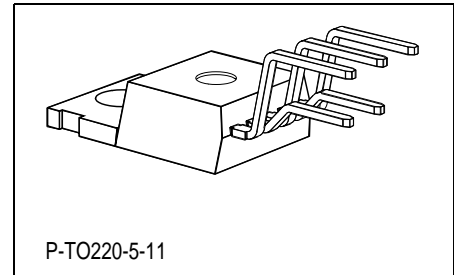

Type	Ordering Code	Package
TLE 4270	Q67000-A9209	P-TO220-5-11
TLE 4270 S	Q67000-A9243	P-TO220-5-12
TLE 4270 G	Q67006-A9201	P-TO263-5-1
TLE 4270 D	Q67006-A9360	P-TO252-5-1, P-TO252-5-11

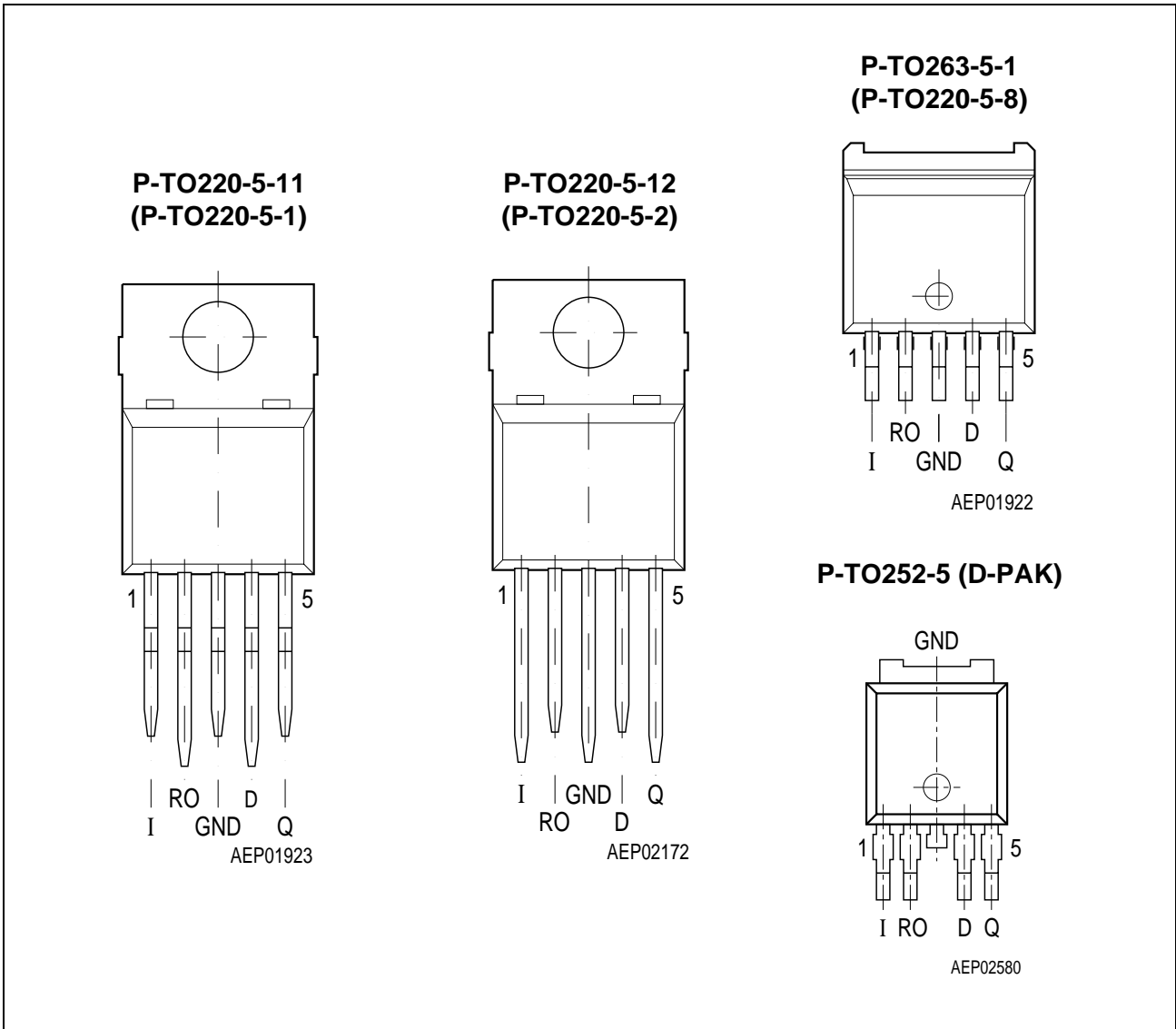

**Figure 1** Pin Configuration (top view)

**Table 1** Pin Definitions and Functions

Pin	Symbol	Function
1	I	<b>Input</b> ; block to ground directly at the IC with a ceramic capacitor.
2	RO	<b>Reset Output</b> ; the open collector output is connected to the 5-V output via an integrated resistor of 30 kΩ.
3	GND	<b>Ground</b> ; internally connected to heatsink.
4	D	<b>Reset Delay</b> ; connect a capacitor to ground for delay time adjustment.
5	Q	<b>5-V Output</b> ; block to ground with 22 μF capacitor, ESR < 3 Ω.

## Circuit Description

The control amplifier compares a reference voltage, which is kept highly accurate by resistance adjustment, to a voltage that is proportional to the output voltage and drives the base of a series transistor via a buffer. Saturation control as a function of the load current prevents any over-saturation of the power element.

The IC also incorporates a number of internal circuits for protection against:

- Overload
- Overvoltage
- Overtemperature
- Reverse polarity

## Application Description

The IC regulates an input voltage in the range of  $5.5\text{ V} < V_I < 36\text{ V}$  to  $V_{Q,\text{nom}} = 5.0\text{ V}$ . Up to 26 V it produces a regulated output current of more than 650 mA. Above 26 V the save-operating-area protection allows operation up to 36 V with a regulated output current of more than 300 mA. Overvoltage protection limits operation at 42 V. The overvoltage protection hysteresis restores operation if the input voltage has dropped below 36 V. A reset signal is generated for an output voltage of  $V_Q < 4.5\text{ V}$ . The delay for power-on reset can be set externally with a capacitor.

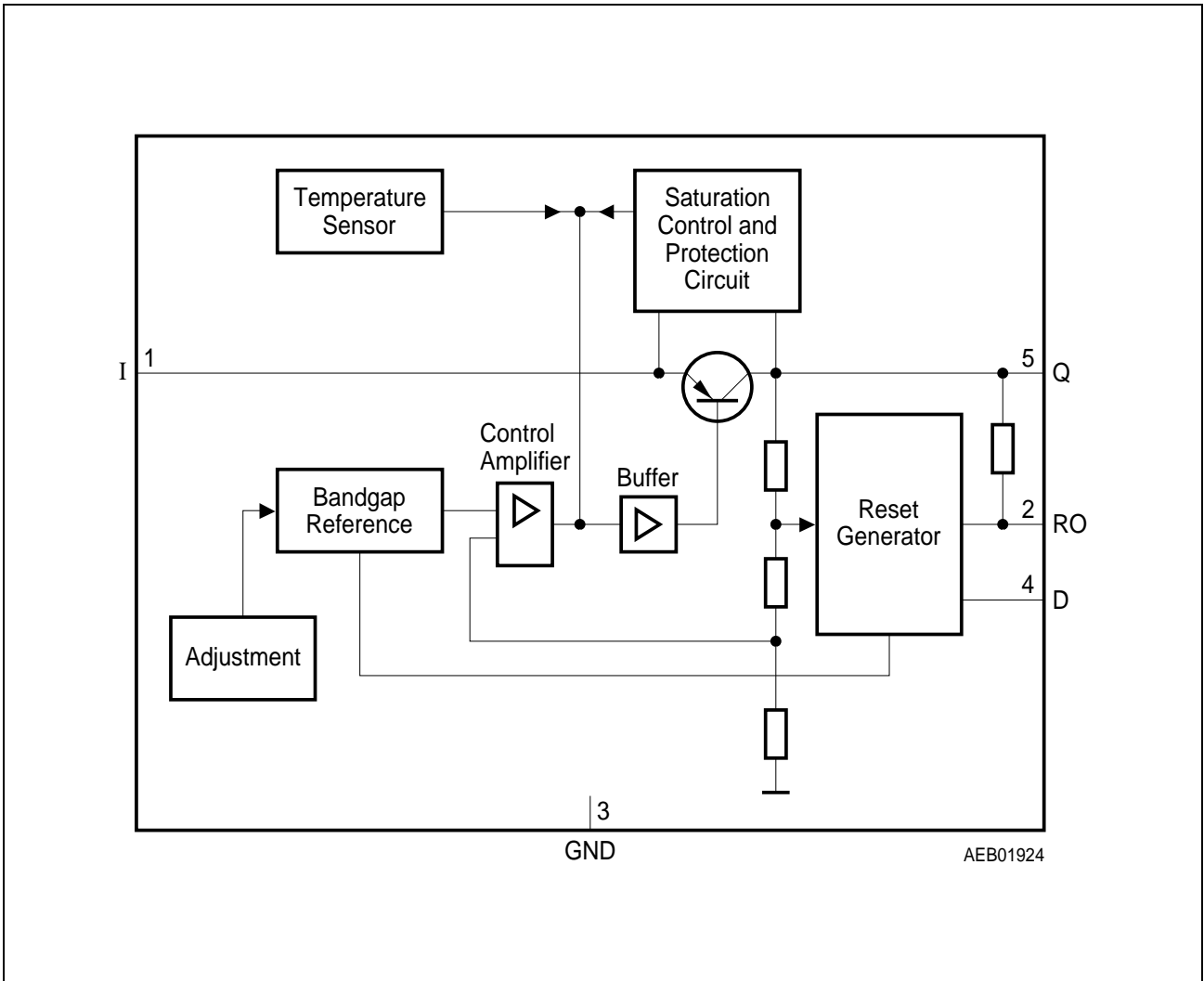

Figure 2 Block Diagram

**Table 2 Absolute Maximum Ratings**

$T_j = -40$  to  $150$  °C

Parameter	Symbol	Limit Values		Unit	Notes
		Min.	Max.		
<b>Input I</b>					
Voltage	$V_I$	-42	42	V	–
Voltage	$V_I$	–	65	V	$t \leq 400$ ms
Current	$I_I$	–	–	–	internally limited
<b>Reset Output RO</b>					
Voltage	$V_{RO}$	-0.3	7	V	–
Current	$I_{RO}$	–	–	–	Internally limited
<b>Reset Delay D</b>					
Voltage	$V_D$	-0.3	7	V	–
Current	$I_D$	–	–	–	Internally limited
<b>Output Q</b>					
Voltage	$V_Q$	-1.0	16	V	–
Current	$I_Q$	–	–	–	Internally limited
<b>Ground GND</b>					
Current	$I_{GND}$	-0.5	–	A	–
<b>Temperatures</b>					
Junction temperature	$T_j$	–	150	°C	–
Storage temperature	$T_{stg}$	-50	150	°C	–

**Table 3 Operating Range**

Parameter	Symbol	Limit Values		Unit	Notes
		Min.	Max.		
Input voltage	$V_I$	6	42	V	–
Junction temperature	$T_j$	-40	150	°C	–
<b>Thermal Resistance</b>					
Junction ambient	$R_{thj-a}$	–	65 79	K/W K/W	– TO263, TO252 <sup>1)</sup>
Junction case	$R_{thj-c}$	–	3	K/W	TO-220/263 Packages

1) Mounted on PCB,  $80 \times 80 \times 1.5$  mm<sup>3</sup>; 35µ Cu; 5µ Sn; Footprint only; zero airflow.

**Table 4 Characteristics**
 $V_I = 13.5\text{ V}; -40\text{ °C} \leq T_j \leq 125\text{ °C}$  (unless otherwise specified)

Parameter	Symbol	Limit Values			Unit	Test Condition
		Min.	Typ.	Max.		
Output voltage	$V_Q$	4.90	5.00	5.10	V	$5\text{ mA} \leq I_Q \leq 550\text{ mA};$ $6\text{ V} \leq V_I \leq 26\text{ V}$
Output voltage	$V_Q$	4.90	5.00	5.10	V	$26\text{ V} \leq V_I \leq 36\text{ V};$ $I_Q \leq 300\text{ mA}$
Output current limiting	$I_{Qmax}$	650	850	–	mA	$V_Q = 0\text{ V}$
Current consumption $I_q = I_I - I_Q$	$I_q$	–	1	1.5	mA	$I_Q = 5\text{ mA}$
Current consumption $I_q = I_I - I_Q$	$I_q$	–	55	75	mA	$I_Q = 550\text{ mA}$
Current consumption $I_q = I_I - I_Q$	$I_q$	–	70	90	mA	$I_Q = 550\text{ mA}; V_I = 5\text{ V}$
Drop voltage	$V_{DR}$	–	350	700	mV	$I_Q = 550\text{ mA}^1)$
Load regulation	$\Delta V_{Q,Lo}$	–	25	50	mV	$I_Q = 5\text{ to }550\text{ mA};$ $V_I = 6\text{ V}$
Line regulation	$\Delta V_{Q,Li}$	–	12	25	mV	$V_I = 6\text{ to }26\text{ V}$ $I_Q = 5\text{ mA}$
Power supply Ripple rejection	$PSRR$	–	54	–	dB	$f_r = 100\text{ Hz};$ $V_r = 0.5\text{ Vpp}$

**Reset Generator**

Switching threshold	$V_{RT}$	4.5	4.65	4.8	V	–
Reset High voltage	$V_{ROH}$	4.5	–	–	V	–
Reset low voltage	$V_{ROL}$	–	60	–	mV	$R_{int} = 30\text{ k}\Omega^2);$ $1.0\text{ V} \leq V_Q \leq 4.5\text{ V}$
Reset low voltage	$V_{ROL}$	–	200	400	mV	$I_R = 3\text{ mA}, V_Q = 4.4\text{ V}$
Reset pull-up	$R_{int}$	18	30	46	k $\Omega$	internally connected to Q
Charge current	$I_{D,c}$	8	14	25	$\mu\text{A}$	$V_D = 1.0\text{ V}$

**Table 4 Characteristics (cont'd)**
 $V_I = 13.5 \text{ V}; -40 \text{ }^\circ\text{C} \leq T_j \leq 125 \text{ }^\circ\text{C}$  (unless otherwise specified)

Parameter	Symbol	Limit Values			Unit	Test Condition
		Min.	Typ.	Max.		
Upper reset timing threshold	$V_{DU}$	1.4	1.8	2.3	V	–
Lower reset timing threshold	$V_{DL}$	0.2	0.45	0.8	V	$V_Q < V_{RT}$
Delay time	$t_{rd}$	–	13	–	ms	$C_D = 100 \text{ nF}$
Reset reaction time	$t_{rr}$	–	–	3	$\mu\text{s}$	$C_D = 100 \text{ nF}$

**Overvoltage Protection**

Turn-Off voltage	$V_{I,ov}$	42	44	46	V	–
------------------	------------	----	----	----	---	---

- 1) Drop voltage =  $V_I - V_Q$  (measured when the output voltage has dropped 100 mV from the nominal value obtained at 13.5 V input)
- 2) Reset peak is always lower than 1.0 V.

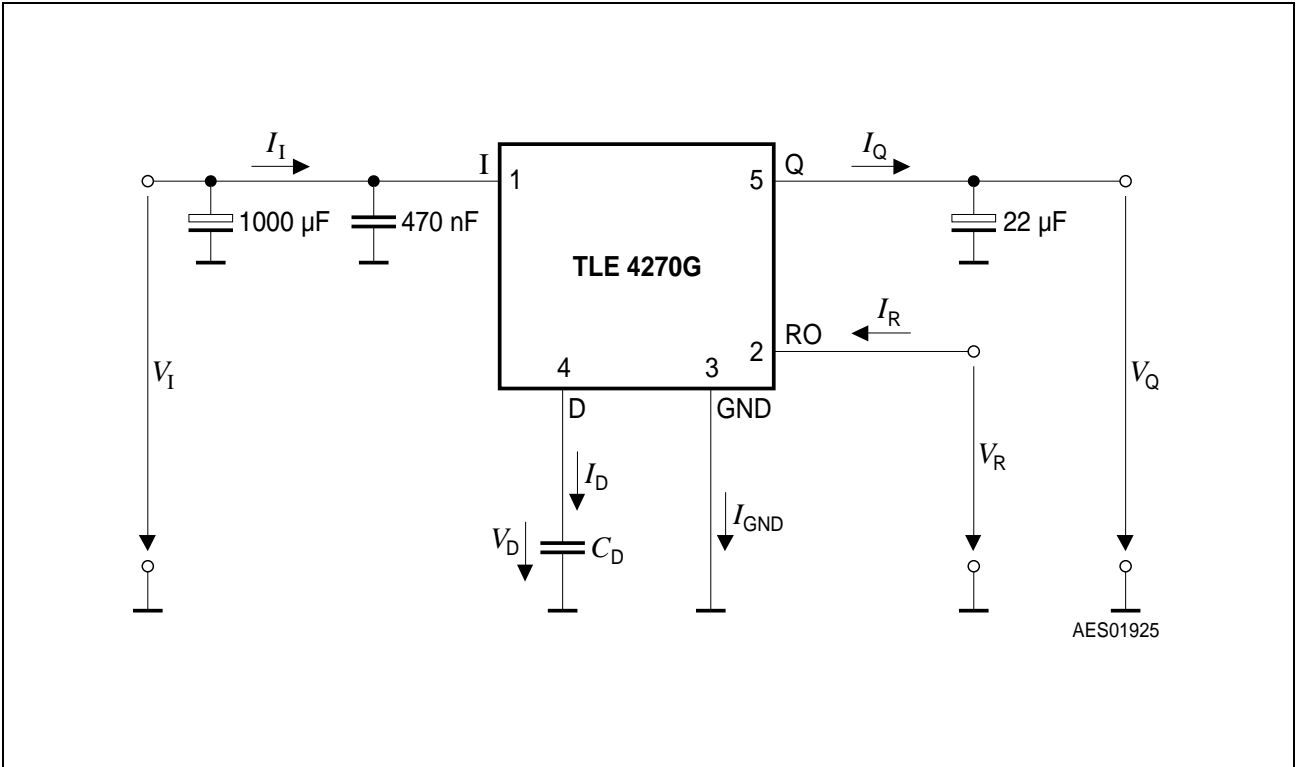

Figure 3 Test Circuit

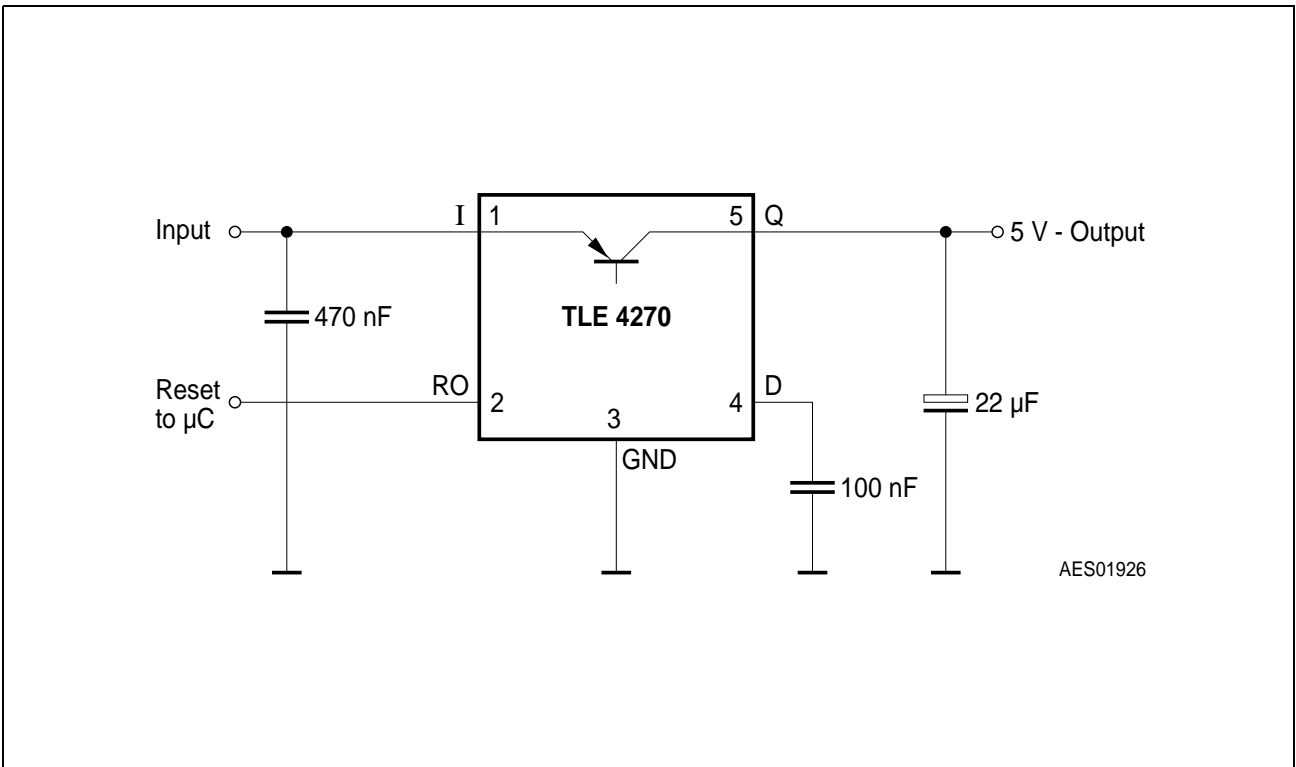

Figure 4 Application Circuit

## Design Notes for External Components

An input capacitor  $C_I$  is necessary for compensation of line influences. The resonant circuit consisting of lead inductance and input capacitance can be damped by a resistor of approx.  $1 \Omega$  in series with  $C_I$ . An output capacitor  $C_Q$  is necessary for the stability of the regulating circuit. Stability is guaranteed at values of  $C_Q \geq 22 \mu\text{F}$  and an ESR of  $< 3 \Omega$ .

## Reset Circuitry

If the output voltage decreases below  $4.5 \text{ V}$ , an external capacitor  $C_D$  on pin 4 (D) will be discharged by the reset generator. If the voltage on this capacitor drops below  $V_{DL}$ , a reset signal is generated on pin 2 (RO), i.e. reset output is set low. If the output voltage rises above the reset threshold,  $C_D$  will be charged with constant current. After the power-on-reset time the voltage on the capacitor reaches  $V_{DU}$  and the reset output will be set high again. The value of the power-on-reset time can be set within a wide range depending of the capacitance of  $C_D$ .

## Reset Timing

The power-on reset delay time is defined by the charging time of an external capacitor  $C_D$  which can be calculated as follows:

$$C_D = (\Delta t \times I_{D,c}) / \Delta V \quad (1)$$

Definitions:

- $C_D$  = delay capacitors
- $\Delta t$  = reset delay time  $t_{rd}$
- $I_{D,c}$  = charge current, typical  $14 \mu\text{A}$
- $\Delta V = V_{DU}$ , typical  $1.8 \text{ V}$

$V_{DU}$  = upper reset timing threshold at  $C_D$  for reset delay time

$$t_{rd} = \Delta V \times C_D / I_{D,c} \quad (2)$$

The reset reaction time  $t_{rr}$  is the time it takes the voltage regulator to set the reset out LOW after the output voltage has dropped below the reset threshold. It is typically  $1 \mu\text{s}$  for delay capacitor of  $47 \text{ nF}$ . For other values for  $C_D$  the reaction time can be estimated using the following equation:

$$t_{rr} \approx 20 \text{ s/F} \times C_D \quad (3)$$

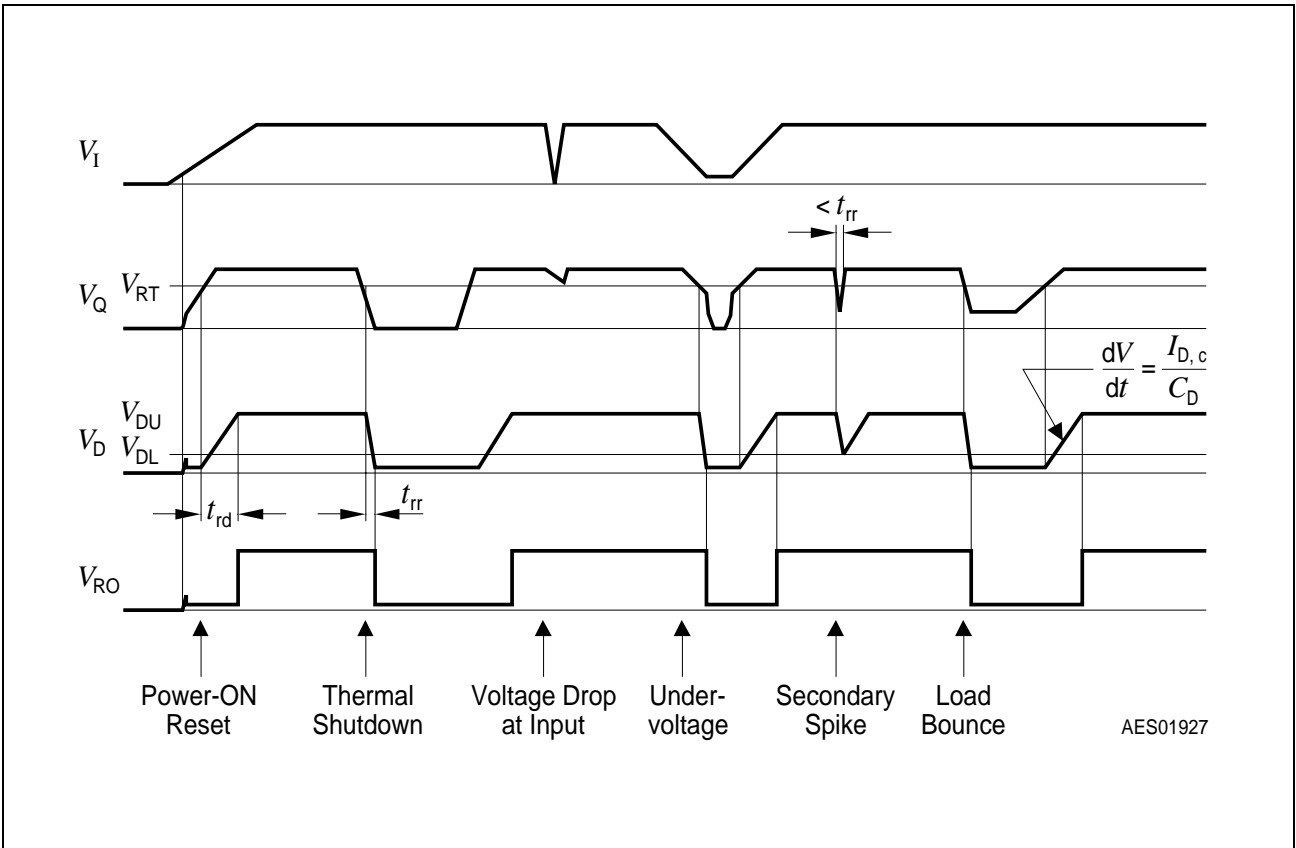
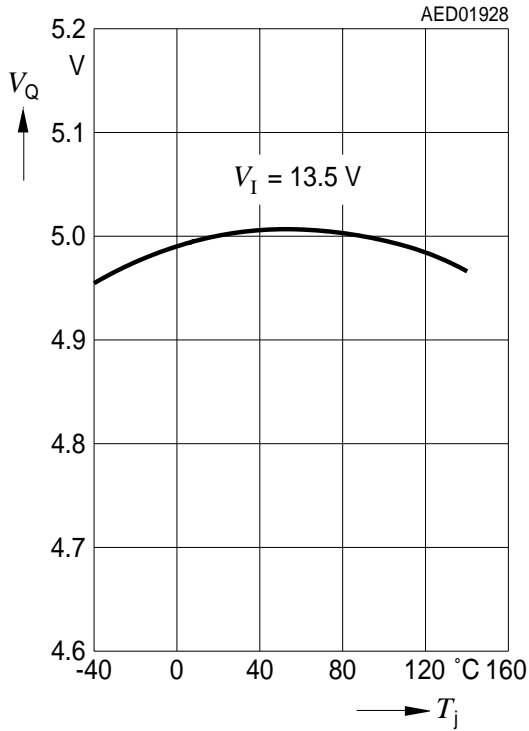
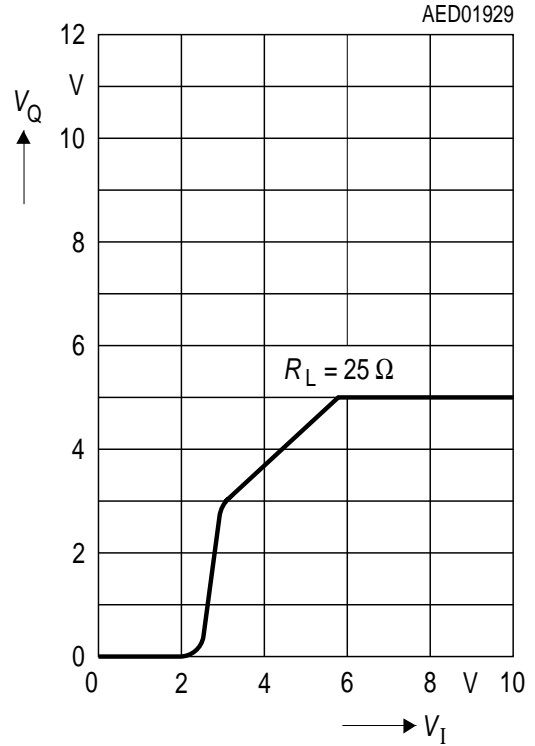

Figure 5 Reset Time Response

**Output Voltage  $V_Q$  versus Temperature  $T_j$**



**Output Voltage  $V_Q$  versus Input Voltage  $V_I$**



**Output Current  $I_Q$  versus Temperature  $T_j$**

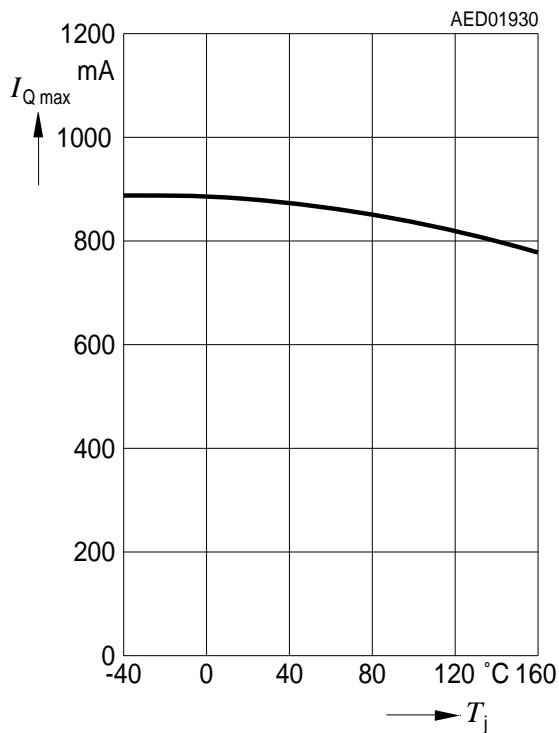

**Output Current  $I_Q$  versus Input Voltage  $V_I$**

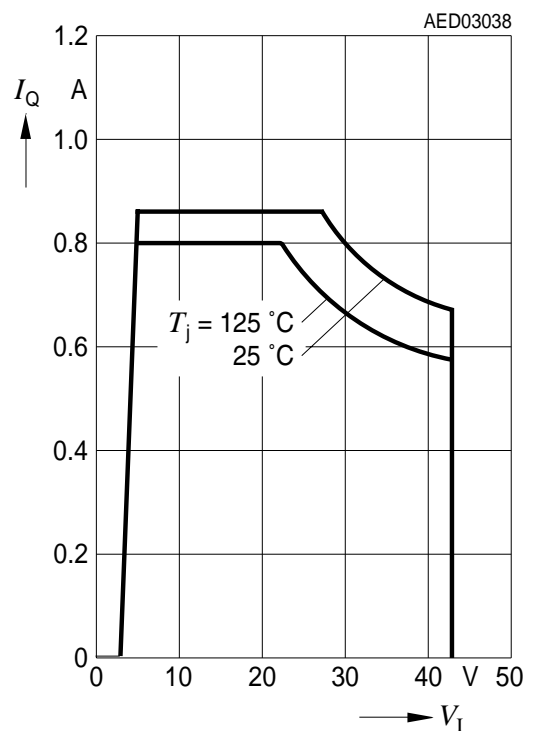

**Current Consumption  $I_q$  versus Output Current  $I_Q$**

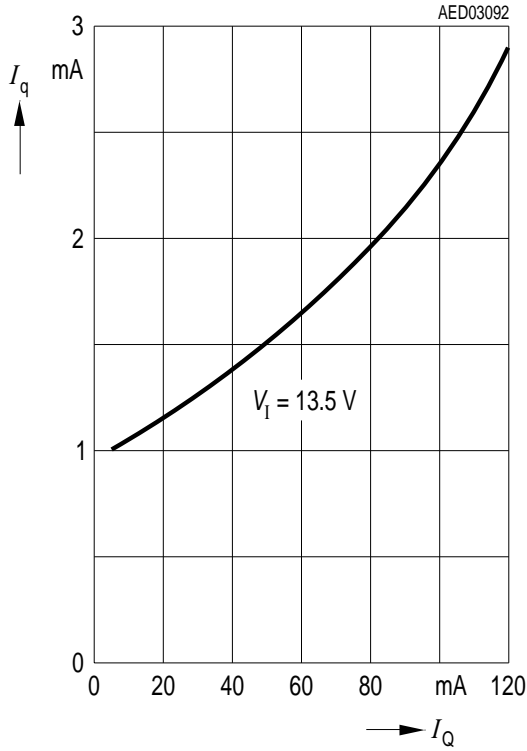

**Current Consumption  $I_q$  versus Output Current  $I_Q$**

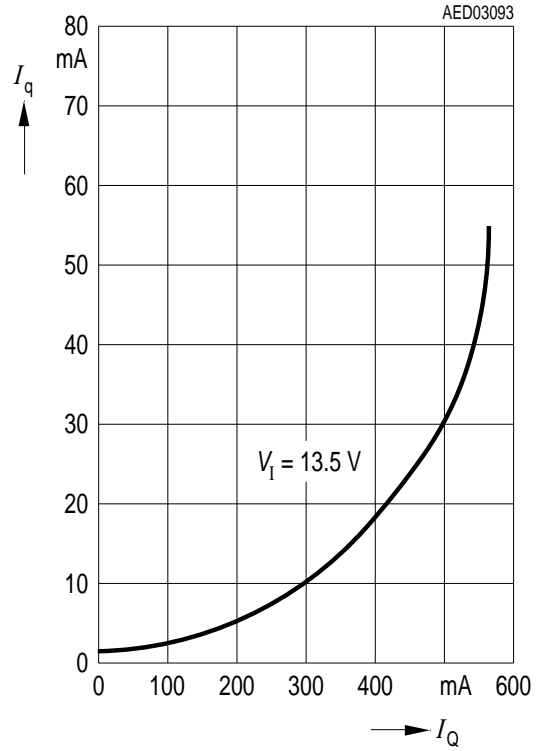

**Current Consumption  $I_q$  versus Input Voltage  $V_I$**

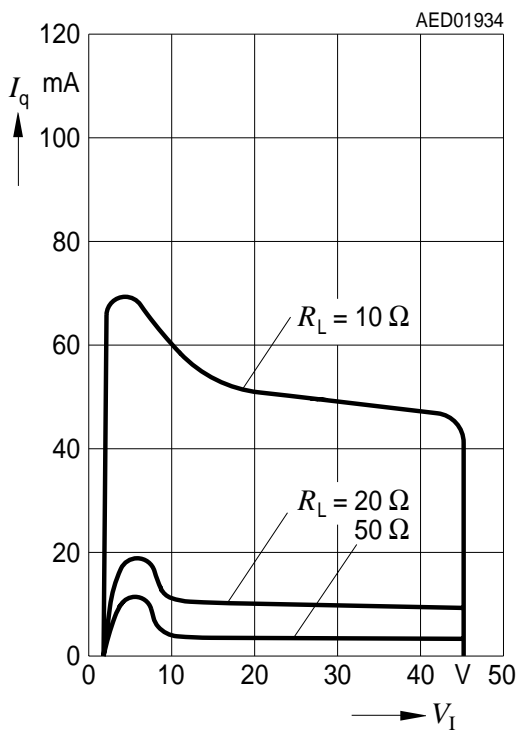

**Drop Voltage  $V_{DR}$  versus Output Current  $I_Q$**

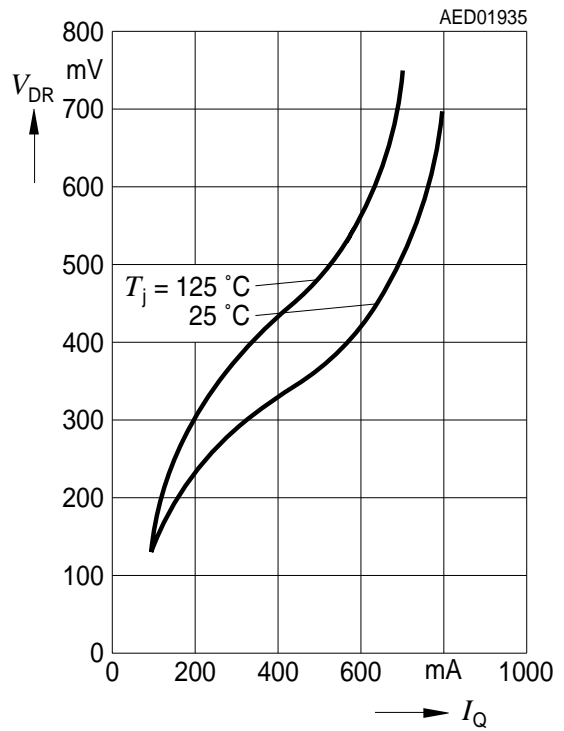

**Charge Current  $I_{D,c}$  versus Temperature  $T_j$**

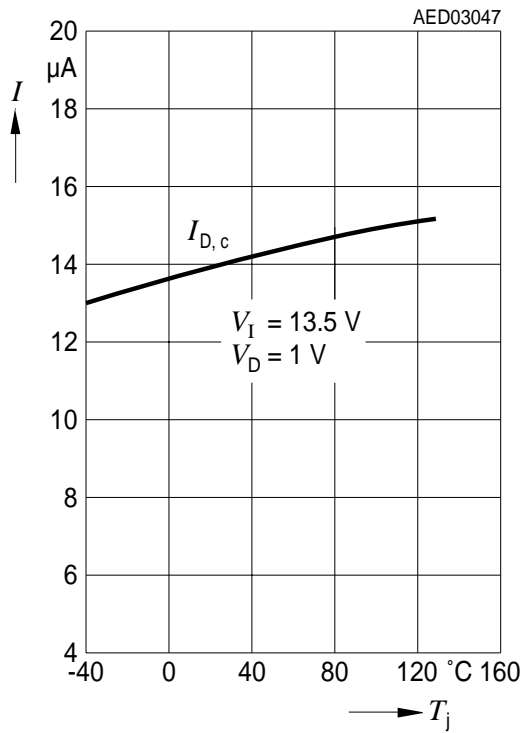

**Upper Reset Timing Threshold  $V_{DU}$  versus Temperature  $T_j$**

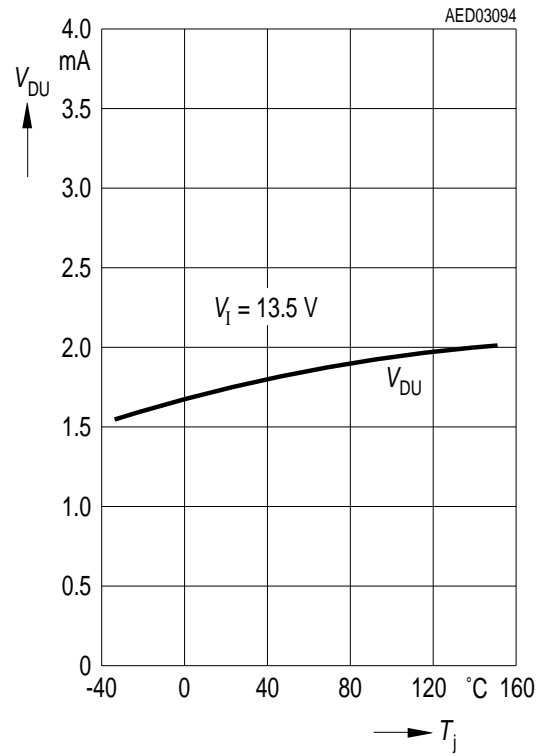

Package Outlines

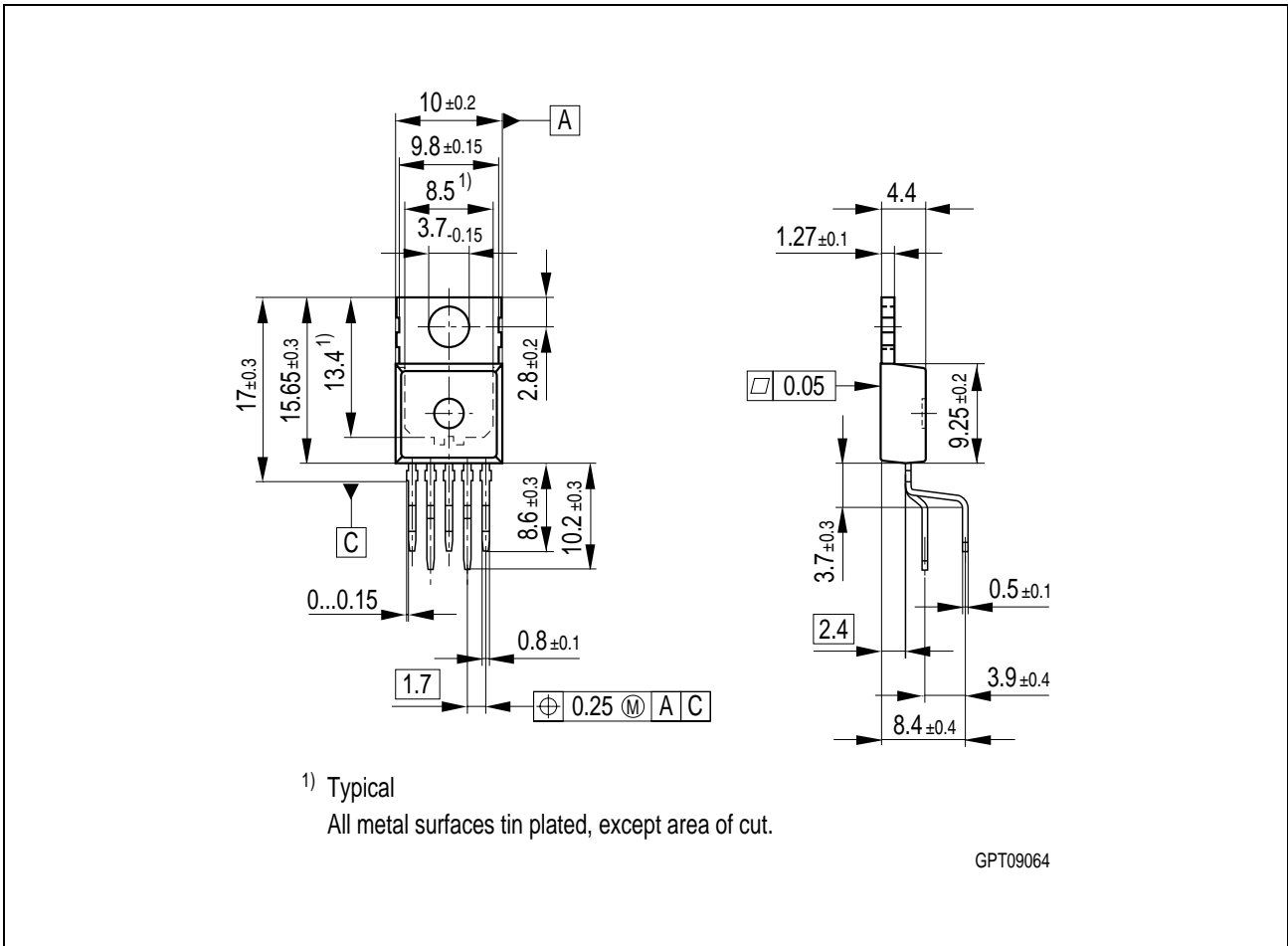
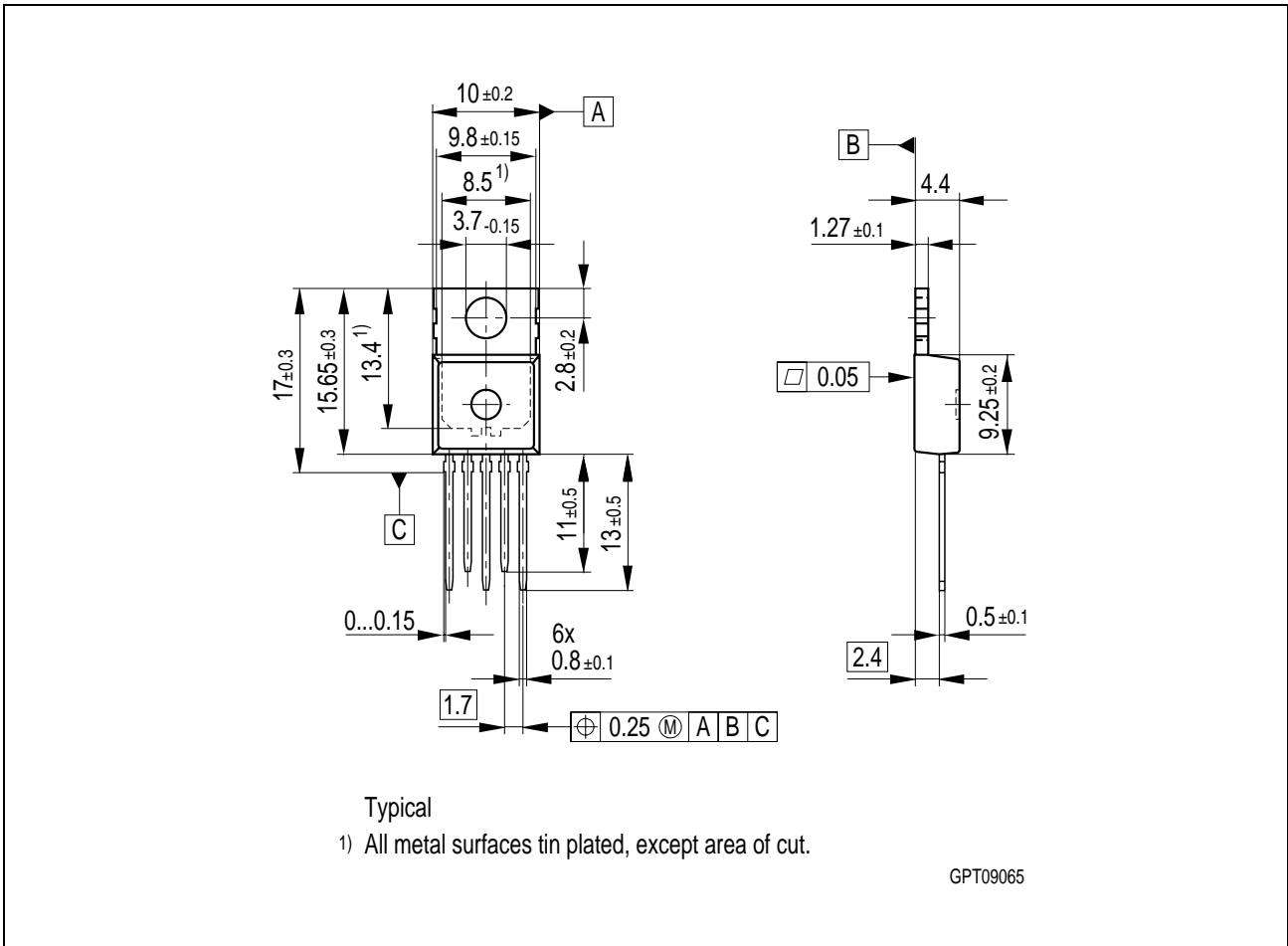

Figure 6 P-T0220-5-11 (Plastic Transistor Single Outline)

You can find all of our packages, sorts of packing and others in our Infineon Internet Page "Products": <http://www.infineon.com/products>.

SMD = Surface Mounted Device

Dimensions in mm

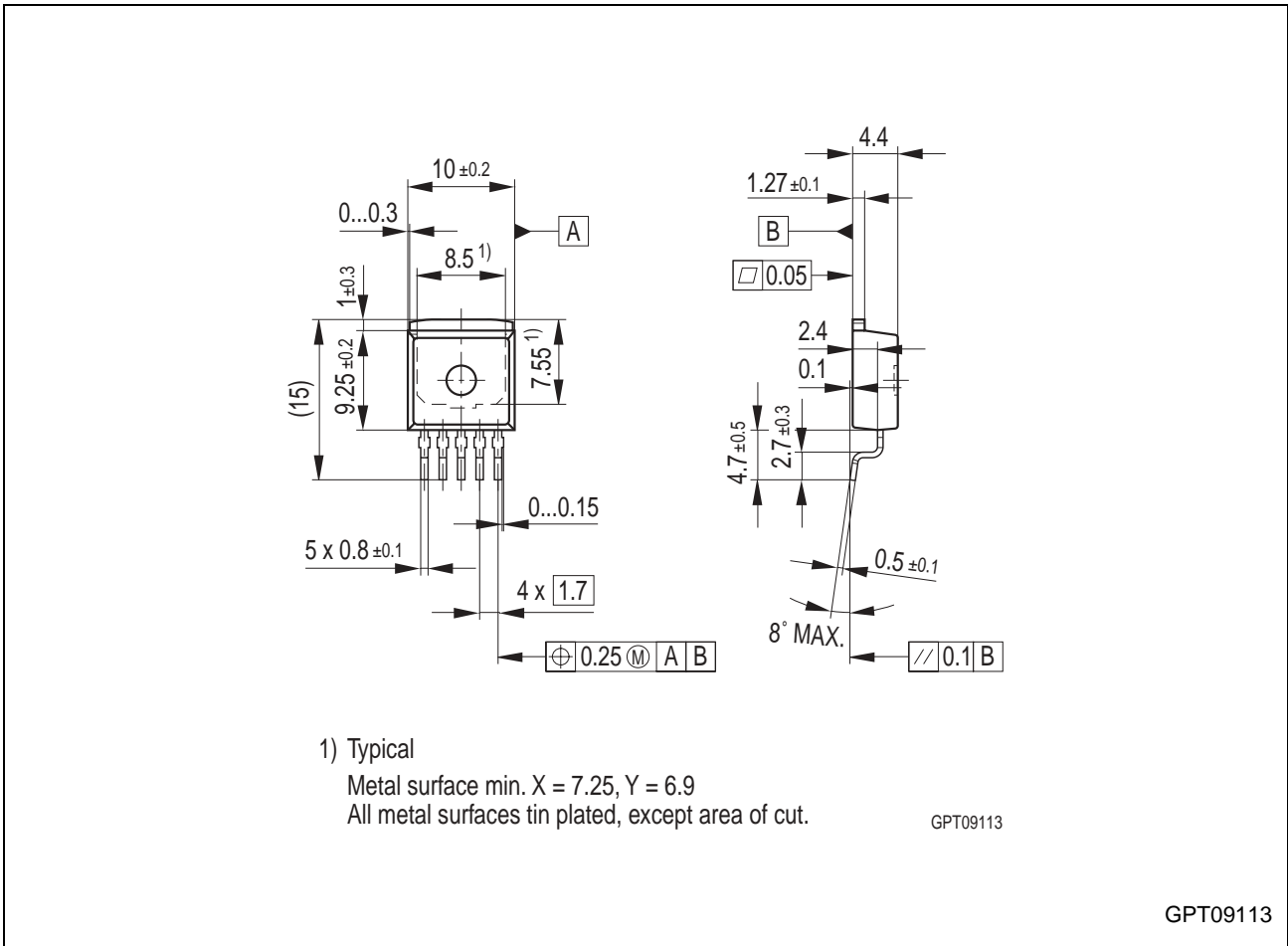

**Figure 7** P-T0220-5-12 (Plastic Transistor Single Outline)

You can find all of our packages, sorts of packing and others in our Infineon Internet Page "Products": <http://www.infineon.com/products>.

SMD = Surface Mounted Device

Dimensions in mm

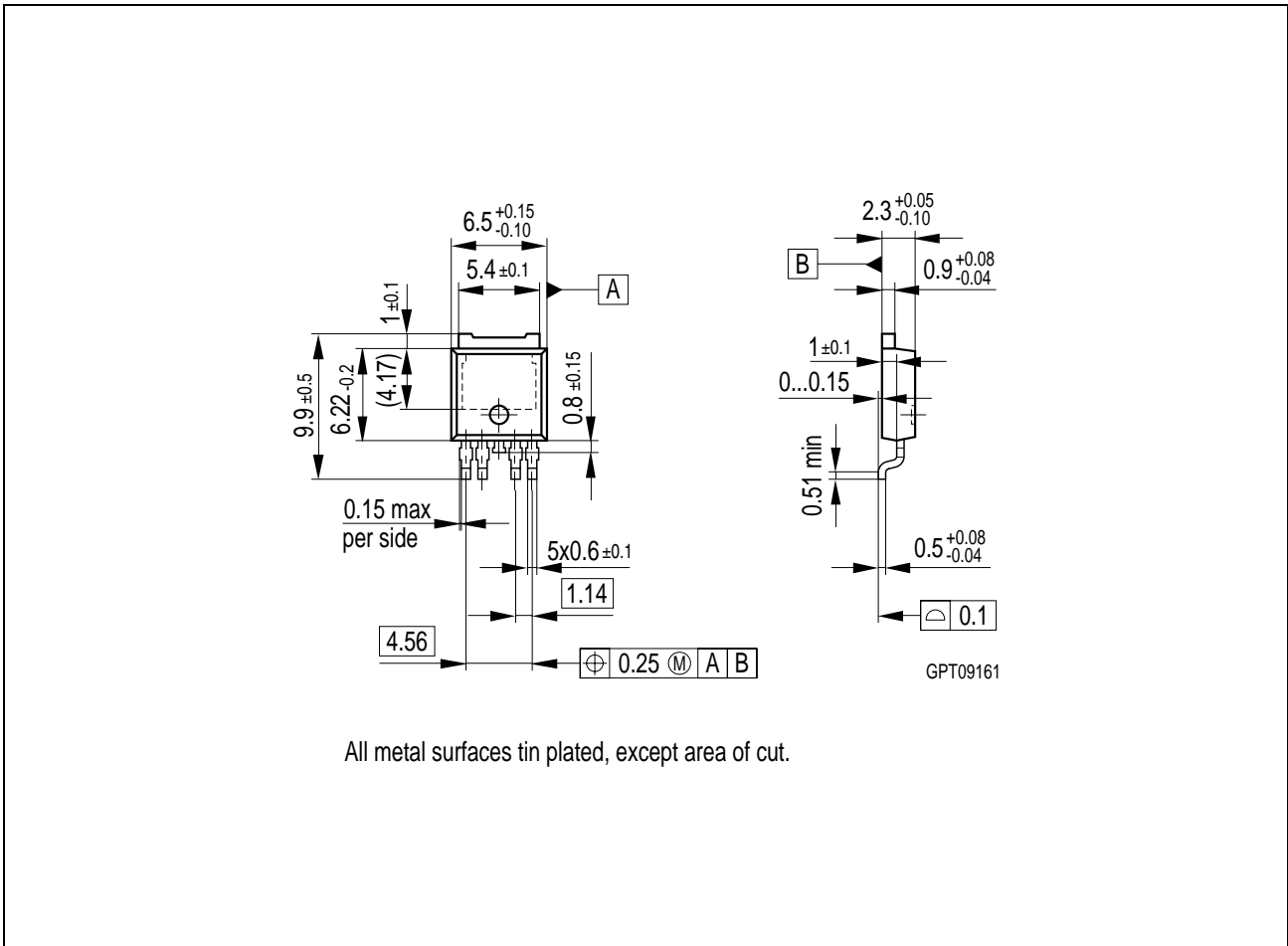

**Figure 8 P-TO263-5-1 (Plastic Transistor Single Outline)**

You can find all of our packages, sorts of packing and others in our Infineon Internet Page "Products": <http://www.infineon.com/products>.

SMD = Surface Mounted Device

Dimensions in mm

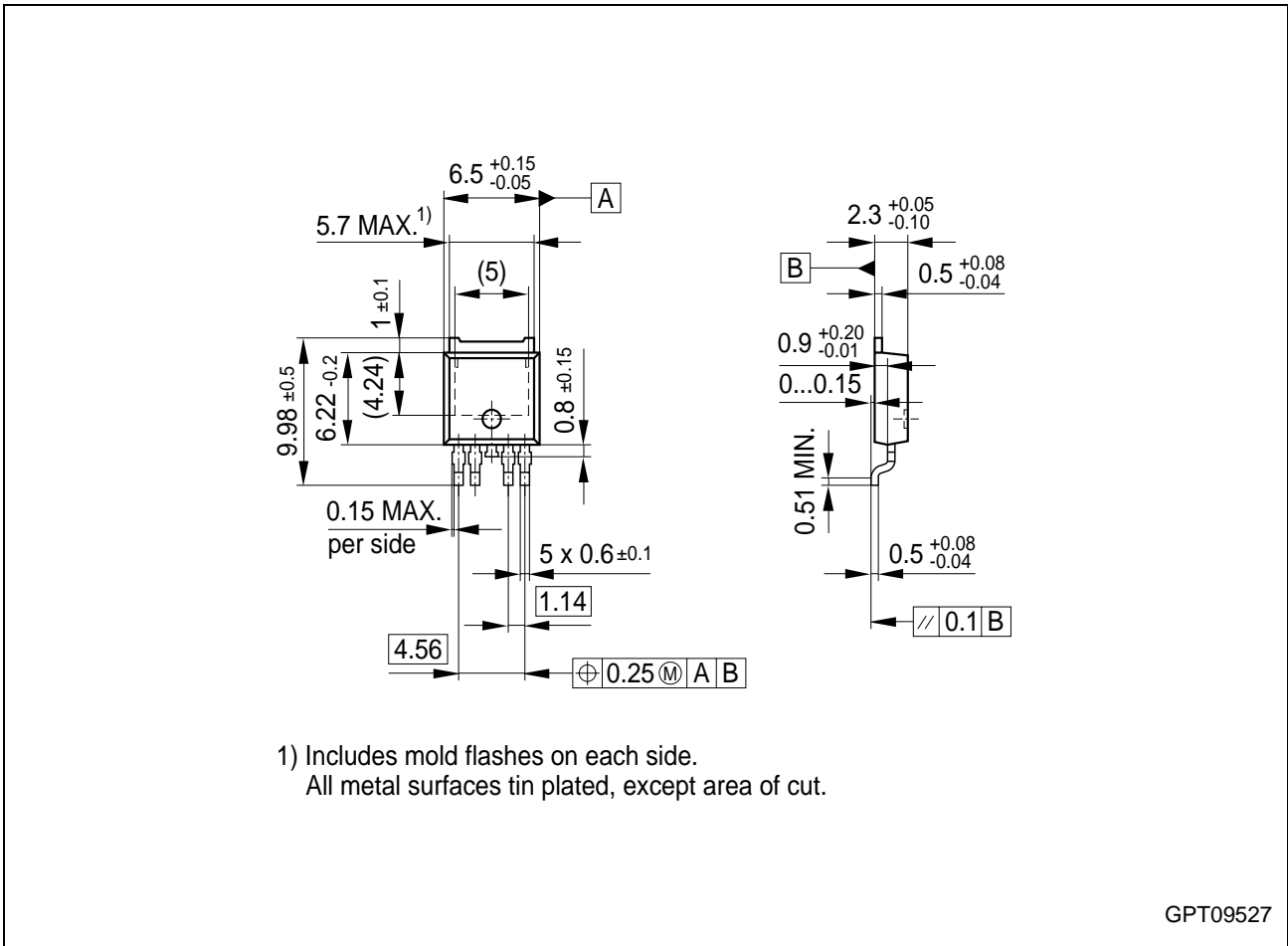

**Figure 9** P-TO252-5-1 (Plastic Transistor Single Outline)

You can find all of our packages, sorts of packing and others in our Infineon Internet Page "Products": <http://www.infineon.com/products>.

SMD = Surface Mounted Device

Dimensions in mm



**Figure 10** P-TO252-5-11 (Plastic Transistor Single Outline)

You can find all of our packages, sorts of packing and others in our Infineon Internet Page "Products": <http://www.infineon.com/products>.

SMD = Surface Mounted Device

Dimensions in mm

**Remarks**

**Edition 2005-08-09**

**Published by Infineon Technologies AG,  
St.-Martin-Strasse 53,  
81669 München, Germany**

**© Infineon Technologies AG 2004.  
All Rights Reserved.**

**Attention please!**

The information herein is given to describe certain components and shall not be considered as a guarantee of characteristics.

Terms of delivery and rights to technical change reserved.

We hereby disclaim any and all warranties, including but not limited to warranties of non-infringement, regarding circuits, descriptions and charts stated herein.

**Information**

For further information on technology, delivery terms and conditions and prices please contact your nearest Infineon Technologies Office ([www.infineon.com](http://www.infineon.com)).

**Warnings**

Due to technical requirements components may contain dangerous substances. For information on the types in question please contact your nearest Infineon Technologies Office.

Infineon Technologies Components may only be used in life-support devices or systems with the express written approval of Infineon Technologies, if a failure of such components can reasonably be expected to cause the failure of that life-support device or system, or to affect the safety or effectiveness of that device or system. Life support devices or systems are intended to be implanted in the human body, or to support and/or maintain and sustain and/or protect human life. If they fail, it is reasonable to assume that the health of the user or other persons may be endangered.

## Looking for pricing, stock, or lifecycle information?

Click below to explore more details on WIN SOURCE:

-  [View TLE4270SNKSA1 on WIN SOURCE](#)
-  [Infineon Technologies Information](#)

## Optimize Your Supply Chain with WIN SOURCE Solutions

-  Global Sourcing Solution
-  Obsolete Management
-  Cost Control Management
-  Shortage Management
-  Alternative Solution
-  Excess Inventory Management