

TLV700 200-mA, Low- I_Q , Low-Dropout Regulator for Portable Devices

1 Features

- Very Low Dropout:
 - 43 mV at $I_{OUT} = 50$ mA, $V_{OUT} = 2.8$ V
 - 85 mV at $I_{OUT} = 100$ mA, $V_{OUT} = 2.8$ V
 - 175 mV at $I_{OUT} = 200$ mA, $V_{OUT} = 2.35$ V
- 2% Accuracy
- Low I_Q : 31 μ A
- Available in Fixed-Output Voltages from 1.2 V to 4.8 V
- High PSRR: 68 dB at 1 kHz
- Stable With Effective Capacitance of 0.1 μ F⁽¹⁾
- Thermal Shutdown and Overcurrent Protection
- Available in 1.5-mm \times 1.5-mm SON-6, SOT23-5, and SC-70 Packages

⁽¹⁾ See the [Input and Output Capacitor Requirements](#).

2 Applications

- Wireless Handsets
- Smart Phones, PDAs
- ZigBee[®] Networks
- Bluetooth[®] Devices
- Li-Ion Operated Handheld Products
- WLAN and Other PC Add-on Cards

3 Description

The TLV700 series of low-dropout (LDO) linear regulators are low quiescent current devices with excellent line and load transient performance. These LDOs are designed for power-sensitive applications. A precision bandgap and error amplifier provides overall 2% accuracy. Low output noise, very high power-supply rejection ratio (PSRR), and low dropout voltage make this series of devices ideal for most battery-operated handheld equipment. All device versions have thermal shutdown and current limit for safety.

Furthermore, these devices are stable with an effective output capacitance of only 0.1 μ F. This feature enables the use of cost-effective capacitors that have higher bias voltages and temperature derating. The devices regulate to specified accuracy with no output load.

The TLV700 series of LDOs are available in 1.5-mm \times 1.5-mm SON-6, SOT-5, and SC70 packages.

Device Information⁽¹⁾

PART NUMBER	PACKAGE	BODY SIZE (NOM)
TL700xx	SC70 (5)	2.00 mm \times 1.25 mm
	SOT (5)	2.90 mm \times 1.60 mm
	WSON (6)	1.50 mm \times 1.50 mm

⁽¹⁾ For all available packages, see the orderable addendum at the end of the data sheet.

Typical Application Circuit

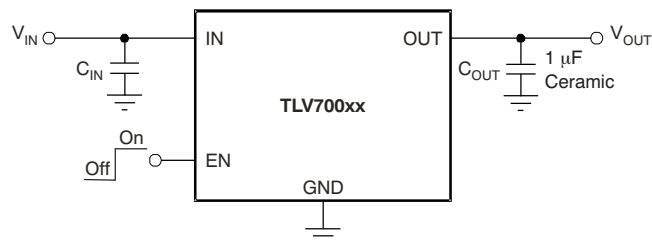

Table of Contents

1 Features	1	8 Application and Implementation	13
2 Applications	1	8.1 Application Information.....	13
3 Description	1	8.2 Typical Application	13
4 Revision History	2	9 Power Supply Recommendations	14
5 Pin Configuration and Functions	4	10 Layout	15
6 Specifications	5	10.1 Layout Guidelines	15
6.1 Absolute Maximum Ratings	5	10.2 Layout Examples.....	15
6.2 ESD Ratings.....	5	10.3 Thermal Protection.....	15
6.3 Recommended Operating Conditions.....	5	10.4 Power Dissipation	16
6.4 Thermal Information	5	11 Device and Documentation Support	17
6.5 Electrical Characteristics.....	6	11.1 Device Support	17
6.6 Typical Characteristics	7	11.2 Documentation Support	17
7 Detailed Description	11	11.3 Trademarks	17
7.1 Overview	11	11.4 Electrostatic Discharge Caution.....	17
7.2 Functional Block Diagram	11	11.5 Glossary	17
7.3 Feature Description.....	11	12 Mechanical, Packaging, and Orderable Information	18
7.4 Device Functional Modes.....	12		

4 Revision History

NOTE: Page numbers for previous revisions may differ from page numbers in the current version.

Changes from Revision D (October 2012) to Revision E	Page
• Added <i>ESD Ratings</i> table, <i>Feature Description</i> section, <i>Device Functional Modes</i> , <i>Application and Implementation</i> section, <i>Power Supply Recommendations</i> section, <i>Layout</i> section, <i>Device and Documentation Support</i> section, and <i>Mechanical, Packaging, and Orderable Information</i> section	1
• Deleted Applications bullet for <i>MP3 Players</i>	1
• Changed front-page graphic	1
• Changed <i>Pin Configuration and Functions</i> section; updated table format	4
• Changed "free-air temperature" to "junction temperature" in <i>Absolute Maximum Ratings</i> condition statement.....	5
• Deleted <i>Dissipation Ratings</i> table	5
• Changed <i>Thermal Information</i> table; updated thermal resistance values for all packages	5

Changes from Revision C (July 2011) to Revision D	Page
• Updated Figure 5	7

Changes from Revision B (December, 2010) to Revision C	Page
• Added footnote 2 to Absolute Maximum Ratings table	5
• Changed <i>output current limit</i> typical and maximum specifications.....	6
• Deleted previous Figure 12, <i>Current Limit vs Input Voltage</i> typical characteristic	7

Changes from Revision A (April, 2010) to Revision B	Page
• Removed TLV701xx device references throughout document	1
• Changed minimum output voltage available from 0.7 V to 1.2 V	1
• Added footnote (1).....	1
• Deleted $V_{OUT} < 1\text{ V}$ specification	6
• Deleted <i>Active pulldown resistance</i> parameter	6

• Changed Figure 4 title	7
• Changed Figure 5 title	7
• Removed TLV701xx block diagram.....	11
• Revised Shutdown section	11
• Updated <i>Application Information</i> section to reflect minimum output voltage availability of 1.2 V	13
• Deleted references to TLV701xx throughout <i>Application Information</i>	13
• Changed footnote 2 for <i>Ordering Information</i> table to reflect minimum output voltage of 1.2 V	17

5 Pin Configuration and Functions



(1) No connection.

Pin Functions

NAME	PIN			I/O	DESCRIPTION
	WSON	SC70	SOT		
IN	1	1	1	I	Input pin. A small, 1- μ F ceramic capacitor is recommended from this pin to ground to assure stability and good transient performance. See Input and Output Capacitor Requirements for more details.
GND	2	2	2	—	Ground pin
EN	6	3	3	I	Enable pin. Driving EN over 0.9 V turns on the regulator. Driving EN below 0.4 V puts the regulator into shutdown mode and reduces operating current to 1 μ A, nominal.
NC	4, 5	4	4	—	No connection. This pin can be tied to ground to improve thermal dissipation.
OUT	3	5	5	O	Regulated output voltage pin. A small, 1- μ F ceramic capacitor is needed from this pin to ground to assure stability. See Input and Output Capacitor Requirements for more details.

6 Specifications

6.1 Absolute Maximum Ratings

over operating junction temperature range (unless otherwise noted) ⁽¹⁾

		MIN	MAX	UNIT
Voltage	V _{IN}	-0.3	6	V
	V _{EN}	-0.3	6 ⁽²⁾	
	V _{OUT}	-0.3	6	
Maximum output current	I _{OUT}	Internally limited		
Output short-circuit duration		Indefinite		
Temperature	Operating junction, T _J	-55	150	°C
	Storage, T _{stg}	-55	150	

- (1) Stresses beyond those listed under *Absolute Maximum Ratings* may cause permanent damage to the device. These are stress ratings only, which do not imply functional operation of the device at these or any other conditions beyond those indicated under *Recommended Operating Conditions*. Exposure to absolute-maximum-rated conditions for extended periods may affect device reliability.
- (2) V_{EN} absolute maximum rating is V_{IN} + 0.3 V or 6 V, whichever is less.

6.2 ESD Ratings

		VALUE	UNIT
V _(ESD) Electrostatic discharge	Human body model (HBM), per ANSI/ESDA/JEDEC JS-001, all pins ⁽¹⁾	±2000	V
	Charged device model (CDM), per JEDEC specification JESD22-C101, all pins ⁽²⁾	±500	

- (1) JEDEC document JEP155 states that 500-V HBM allows safe manufacturing with a standard ESD control process.
- (2) JEDEC document JEP157 states that 250-V CDM allows safe manufacturing with a standard ESD control process.

6.3 Recommended Operating Conditions

over operating free-air temperature range (unless otherwise noted)

	MIN	NOM	MAX	UNIT
V _{IN}	2		5.5	V
V _{OUT}	1.2		4.8	V
I _{OUT}	0		200	mA

6.4 Thermal Information

THERMAL METRIC ⁽¹⁾		TLV700			UNIT
		DCK [SC70]	DDC [SOT]	DSE [WSON]	
		5 PINS	5 PINS	6 PINS	
R _{θJA}	Junction-to-ambient thermal resistance	307.6	235.9	321.3	°C/W
R _{θJC(top)}	Junction-to-case (top) thermal resistance	79.1	61.9	207.9	
R _{θJB}	Junction-to-board thermal resistance	93.7	54	281.5	
ψ _{JT}	Junction-to-top characterization parameter	1.3	0.8	42.4	
ψ _{JB}	Junction-to-board characterization parameter	92.8	53.4	284.8	
R _{θJC(bot)}	Junction-to-case (bottom) thermal resistance	n/a	n/a	142.3	

- (1) For more information about traditional and new thermal metrics, see the *IC Package Thermal Metrics* application report, [SPRA953](#).

6.5 Electrical Characteristics

At $V_{IN} = V_{OUT(nom)} + 0.3\text{ V}$ or 2 V (whichever is greater); $I_{OUT} = 10\text{ mA}$, $V_{EN} = 0.9\text{ V}$, $C_{OUT} = 1\text{ }\mu\text{F}$, and $T_J = -40^\circ\text{C}$ to $+125^\circ\text{C}$, unless otherwise noted. Typical values are at $T_J = 25^\circ\text{C}$.

PARAMETER		TEST CONDITIONS	MIN	TYP	MAX	UNIT
V_{IN}	Input voltage range		2		5.5	V
V_{OUT}	DC output accuracy	$-40^\circ\text{C} \leq T_J \leq +125^\circ\text{C}$	-2%		2%	
$\Delta V_{OUT(\Delta V_{IN})}$	Line regulation	$V_{OUT(nom)} + 0.3\text{ V} \leq V_{IN} \leq 5.5\text{ V}$, $I_{OUT} = 10\text{ mA}$		1	5	mV
$\Delta V_{OUT(\Delta I_{OUT})}$	Load regulation	$0\text{ mA} \leq I_{OUT} \leq 200\text{ mA}$		1	15	mV
V_{DO}	Dropout voltage ⁽¹⁾	$V_{IN} = 0.98 \times V_{OUT(nom)}$, $I_{OUT} = 50\text{ mA}$, $V_{OUT} = 2.8\text{ V}$		43		mV
		$V_{IN} = 0.98 \times V_{OUT(nom)}$, $I_{OUT} = 100\text{ mA}$, $V_{OUT} = 2.8\text{ V}$		85		
		$V_{IN} = 0.98 \times V_{OUT(nom)}$, $I_{OUT} = 200\text{ mA}$, $V_{OUT} = 2.35\text{ V}$		175	250	
I_{CL}	Output current limit	$V_{OUT} = 0.9 \times V_{OUT(nom)}$	220		860	mA
I_{GND}	Ground pin current	$I_{OUT} = 0\text{ mA}$		31	55	μA
		$I_{OUT} = 200\text{ mA}$, $V_{IN} = V_{OUT} + 0.5\text{ V}$		270		
I_{SHDN}	Ground pin current (shutdown)	$V_{EN} \leq 0.4\text{ V}$, $V_{IN} = 2\text{ V}$		400		nA
		$V_{EN} \leq 0.4\text{ V}$, $2\text{ V} \leq V_{IN} \leq 4.5\text{ V}$		1	2	μA
PSRR	Power-supply rejection ratio	$V_{IN} = 2.3\text{ V}$, $V_{OUT} = 1.8\text{ V}$, $I_{OUT} = 10\text{ mA}$, $f = 1\text{ kHz}$		68		dB
V_n	Output noise voltage	$BW = 100\text{ Hz}$ to 100 kHz , $V_{IN} = 2.3\text{ V}$, $V_{OUT} = 1.8\text{ V}$, $I_{OUT} = 10\text{ mA}$		48		μV_{RMS}
t_{STR}	Start-up time ⁽²⁾	$C_{OUT} = 1\text{ }\mu\text{F}$, $I_{OUT} = 200\text{ mA}$		100		μs
$V_{EN(high)}$	Enable pin high (enabled)		0.9		V_{IN}	V
$V_{EN(low)}$	Enable pin low (disabled)		0		0.4	V
I_{EN}	Enable pin current	$V_{IN} = V_{EN} = 5.5\text{ V}$		0.04	0.5	μA
UVLO	Undervoltage lockout	V_{IN} rising		1.9		V
T_{sd}	Thermal shutdown temperature	Shutdown, temperature increasing		160		$^\circ\text{C}$
		Reset, temperature decreasing		140		
T_J	Operating junction temperature		-40		125	$^\circ\text{C}$

(1) V_{DO} is measured for devices with $V_{OUT(nom)} \geq 2.35\text{ V}$.

(2) Start-up time = time from EN assertion to $0.98 \times V_{OUT(nom)}$.

6.6 Typical Characteristics

Over operating temperature range ($T_J = -40^{\circ}\text{C}$ to $+125^{\circ}\text{C}$), $V_{IN} = V_{OUT(nom)} + 0.5\text{ V}$ or 2 V , whichever is greater; $I_{OUT} = 10\text{ mA}$, $V_{EN} = V_{IN}$, $C_{OUT} = 1\text{ }\mu\text{F}$, unless otherwise noted. Typical values are at $T_J = 25^{\circ}\text{C}$.

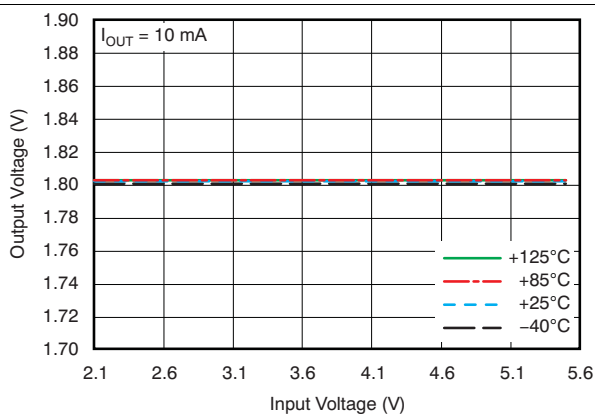

Figure 1. TLV70018 Line Regulation

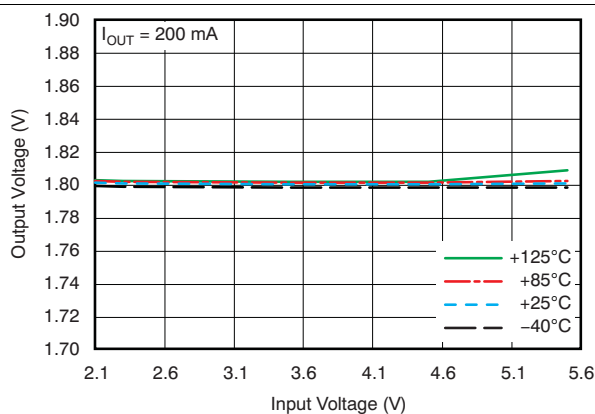

Figure 2. TLV70018 Line Regulation

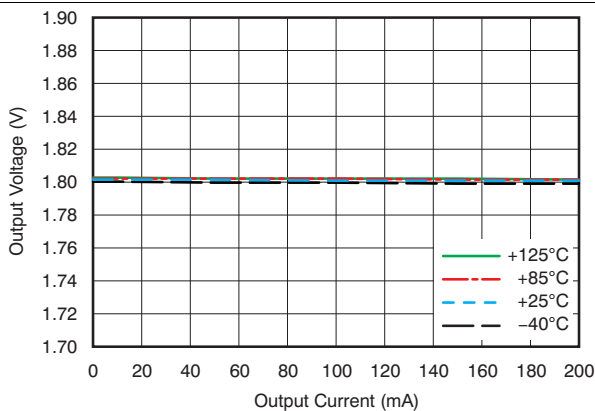

Figure 3. TLV70018 Load Regulation

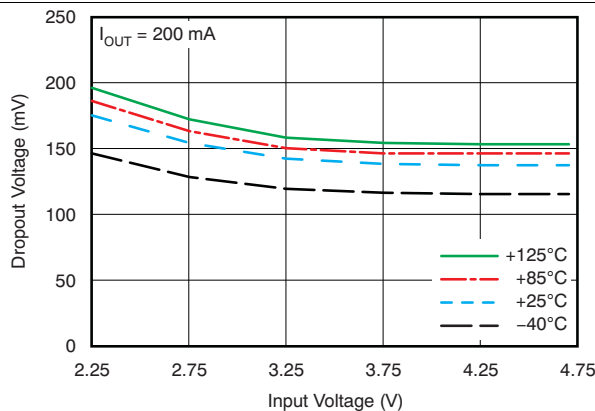

Figure 4. Dropout Voltage vs Input Voltage

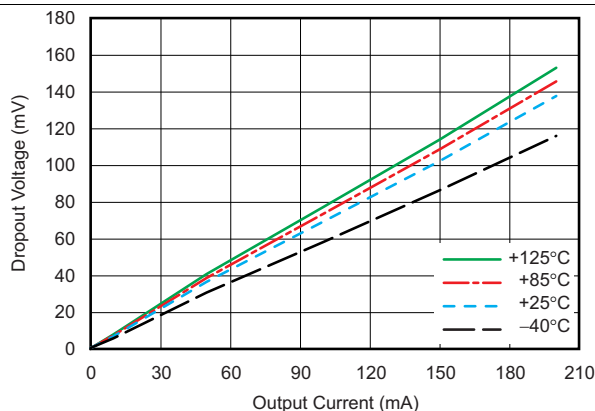

Figure 5. Dropout Voltage vs Output Current, $V_{OUT} = 4.8\text{ V}$

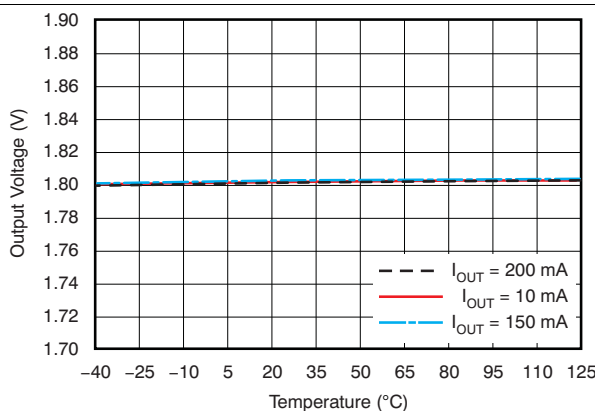

Figure 6. TLV70018 Output Voltage vs Temperature

Typical Characteristics (continued)

Over operating temperature range ($T_J = -40^{\circ}\text{C}$ to $+125^{\circ}\text{C}$), $V_{IN} = V_{OUT(nom)} + 0.5\text{ V}$ or 2 V , whichever is greater; $I_{OUT} = 10\text{ mA}$, $V_{EN} = V_{IN}$, $C_{OUT} = 1\text{ }\mu\text{F}$, unless otherwise noted. Typical values are at $T_J = 25^{\circ}\text{C}$.

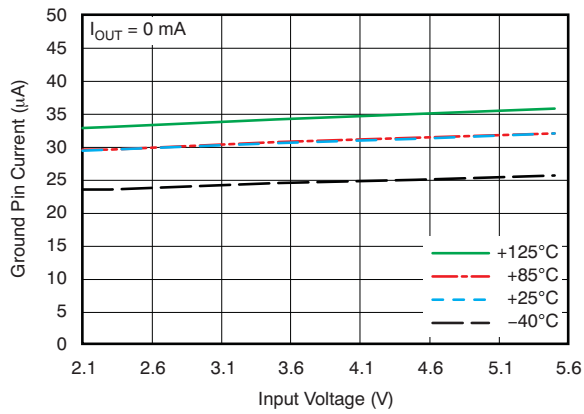

Figure 7. TLV70018 Ground Pin Current vs Input Voltage

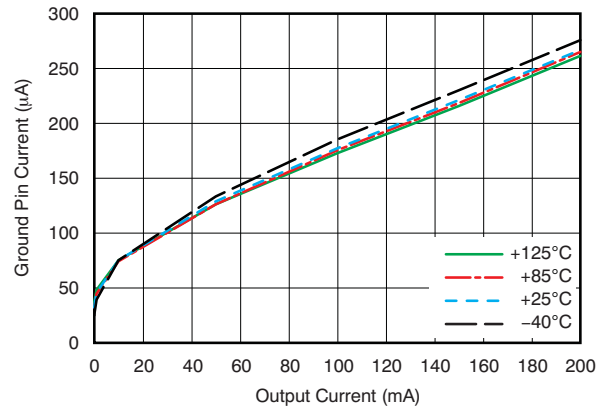

Figure 8. TLV70018 Ground Pin Current vs Load

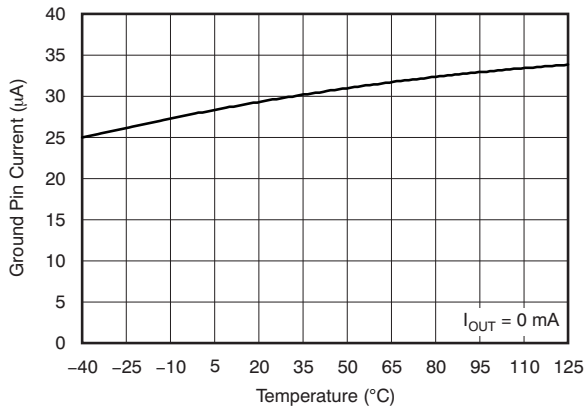

Figure 9. TLV70018 Ground Pin Current vs Temperature

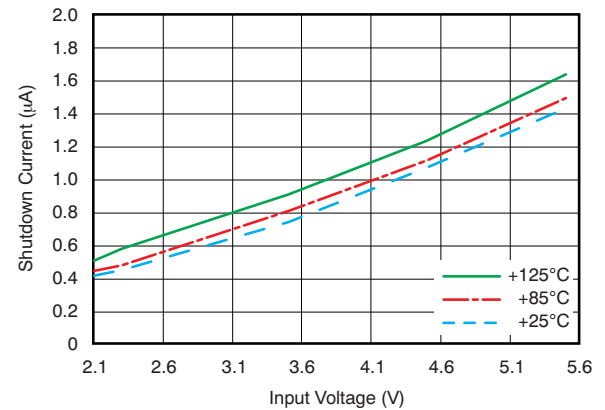

Figure 10. TLV70018 Shutdown Current vs Input Voltage



Figure 11. TLV70018 Power-Supply Ripple Rejection vs Frequency

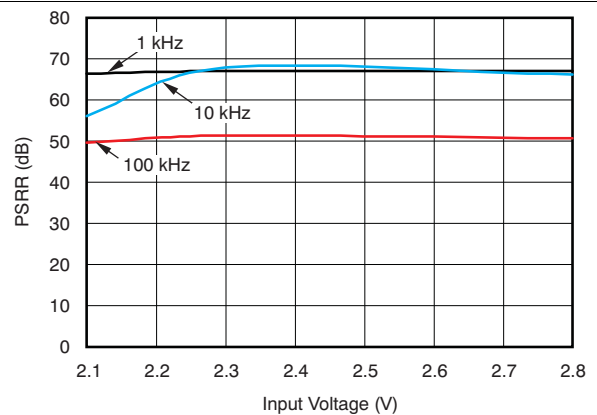

Figure 12. TLV70018 Power-Supply Ripple Rejection vs Input Voltage

Typical Characteristics (continued)

Over operating temperature range ($T_J = -40^{\circ}\text{C}$ to $+125^{\circ}\text{C}$), $V_{IN} = V_{OUT(nom)} + 0.5\text{ V}$ or 2 V , whichever is greater; $I_{OUT} = 10\text{ mA}$, $V_{EN} = V_{IN}$, $C_{OUT} = 1\text{ }\mu\text{F}$, unless otherwise noted. Typical values are at $T_J = 25^{\circ}\text{C}$.



Figure 13. TLV70018 Output Spectral Noise Density vs Output Voltage



Figure 14. TLV70018 Load Transient Response



Figure 15. TLV70018 Load Transient Response



Figure 16. TLV70018 Load Transient Response



Figure 17. TLV70018 Line Transient Response



Figure 18. TLV70018 Line Transient Response

Typical Characteristics (continued)

Over operating temperature range ($T_J = -40^{\circ}\text{C}$ to $+125^{\circ}\text{C}$), $V_{IN} = V_{OUT(nom)} + 0.5\text{ V}$ or 2 V , whichever is greater; $I_{OUT} = 10\text{ mA}$, $V_{EN} = V_{IN}$, $C_{OUT} = 1\text{ }\mu\text{F}$, unless otherwise noted. Typical values are at $T_J = 25^{\circ}\text{C}$.



Figure 19. TLV70018 Line Transient Response

Figure 20. TLV70018 V_{IN} Ramp-Up, Ramp-Down Response

7 Detailed Description

7.1 Overview

The TLV700 series of LDO linear regulators are low quiescent current devices with excellent line and load transient performance. These LDOs are designed for power-sensitive applications. A precision bandgap and error amplifier provides overall 2% accuracy. Low output noise, very high PSRR, and low dropout voltage make this series of devices ideal for most battery-operated handheld equipment. All device versions have integrated thermal shutdown, current limit, and undervoltage lockout (UVLO).

7.2 Functional Block Diagram



7.3 Feature Description

7.3.1 Internal Current Limit

The TLV700 internal current limit helps to protect the regulator during fault conditions. During current limit, the output sources a fixed amount of current that is largely independent of the output voltage. In such a case, the output voltage is not regulated, and is $V_{OUT} = I_{CL} \times R_{LOAD}$. The PMOS pass transistor dissipates $(V_{IN} - V_{OUT}) \times I_{CL}$ until thermal shutdown is triggered and the device turns off. As the device cools down, it is turned on by the internal thermal shutdown circuit. If the fault condition continues, the device cycles between current limit and thermal shutdown. See [Thermal Protection](#) for more details.

The PMOS pass element in the TLV700 has a built-in body diode that conducts current when the voltage at OUT exceeds the voltage at IN. This current is not limited, so if extended reverse voltage operation is anticipated, external limiting to 5% of the rated output current is recommended.

7.3.2 Shutdown

The enable pin (EN) is active high. The device is enabled when voltage at EN pin goes above 0.9 V. The device is turned off when the EN pin is held at less than 0.4 V. When shutdown capability is not required, EN can be connected to the IN pin.

Feature Description (continued)

7.3.3 Dropout Voltage

The TLV700 uses a PMOS pass transistor to achieve low dropout. When $(V_{IN} - V_{OUT})$ is less than the dropout voltage (V_{DO}), the PMOS pass device is in the linear region of operation and the input-to-output resistance is the $R_{DS(on)}$ of the PMOS pass element. V_{DO} scales approximately with output current because the PMOS device behaves as a resistor in dropout.

As with any linear regulator, PSRR and transient response are degraded as $(V_{IN} - V_{OUT})$ approaches dropout. This effect is shown in [Figure 12](#) in [Typical Characteristics](#).

7.3.4 Undervoltage Lockout (UVLO)

The TLV700 uses a UVLO circuit to keep the output shut off until internal circuitry is operating properly.

7.4 Device Functional Modes

7.4.1 Normal Operation

The device regulates to the nominal output voltage under the following conditions:

- The input voltage is greater than the nominal output voltage added to the dropout voltage.
- The output current is less than the current limit.
- The input voltage is greater than the UVLO voltage.

7.4.2 Dropout Operation

If the input voltage is lower than the nominal output voltage plus the specified dropout voltage, but all other conditions are met for normal operation, the device operates in dropout mode. In this condition, the output voltage is the same the input voltage minus the dropout voltage. The transient performance of the device is significantly degraded because the pass device is in a triode state and no longer regulates the output voltage of the LDO. Line or load transients in dropout may result in large output voltage deviations.

[Table 1](#) lists the conditions that lead to the different modes of operation.

Table 1. Device Functional Mode Comparison

OPERATING MODE	PARAMETER	
	V_{IN}	I_{OUT}
Normal mode	$V_{IN} > V_{OUT(nom)} + V_{DO}$	$I_{OUT} < I_{CL}$
Dropout mode	$V_{IN} < V_{OUT(nom)} + V_{DO}$	$I_{OUT} < I_{CL}$
Current limit	$V_{IN} > UVLO$	$I_{OUT} > I_{CL}$

8 Application and Implementation

NOTE

Information in the following applications sections is not part of the TI component specification, and TI does not warrant its accuracy or completeness. TI's customers are responsible for determining suitability of components for their purposes. Customers should validate and test their design implementation to confirm system functionality.

8.1 Application Information

The TLV700 belongs to a new family of next-generation value LDO regulators. These devices consume low quiescent current and deliver excellent line and load transient performance. These characteristics, combined with low noise, very good PSRR with little ($V_{IN} - V_{OUT}$) headroom, make this family of devices ideal for RF portable applications. This family of regulators offers current limit and thermal protection, and is specified from -40°C to $+125^{\circ}\text{C}$.

8.2 Typical Application

Figure 21 shows a typical application circuit.



Figure 21. Typical Application Circuit

8.2.1 Design Requirements

Table 2 lists the design parameters.

Table 2. Design Parameters

PARAMETER	DESIGN REQUIREMENT
Input voltage	2.5 V to 3.3 V
Output voltage	1.8 V
Output current	100 mA

8.2.2 Detailed Design Procedure

8.2.2.1 Input and Output Capacitor Requirements

TI recommends using 1- μF X5R- and X7R-type ceramic capacitors because these capacitors have minimal variation in value and equivalent series resistance (ESR) over temperature.

However, the TLV700 is designed to be stable with an *effective capacitance* of 0.1 μF or larger at the output. Thus, the device is stable with capacitors of other dielectric types as well, as long as the effective capacitance under operating bias voltage and temperature is greater than 0.1 μF . This effective capacitance refers to the capacitance that the LDO sees under operating bias voltage and temperature conditions; that is, the capacitance after taking both bias voltage and temperature derating into consideration. In addition to allowing the use of cheaper dielectrics, this capability of being stable with 0.1- μF effective capacitance also enables the use of smaller footprint capacitors that have higher derating in size- and space-constrained applications.

Using a 0.1- μF rated capacitor at the output of the LDO does not ensure stability because the effective capacitance under the specified operating conditions must not be less than 0.1 μF . Maximum ESR should be less than 200 m Ω .

Although an input capacitor is not required for stability, it is good analog design practice to connect a 0.1- μF to 1- μF , low ESR capacitor across the IN pin and GND in of the regulator. This capacitor counteracts reactive input sources and improves transient response, noise rejection, and ripple rejection. A higher-value capacitor may be necessary if large, fast rise-time load transients are anticipated, or if the device is not located close to the power source. If source impedance is more than 2 Ω , a 0.1- μF input capacitor may be necessary to ensure stability.

8.2.2.2 Transient Response

As with any regulator, increasing the size of the output capacitor reduces overshoot and undershoot magnitude but increases the duration of the transient response.

8.2.3 Application Curves



9 Power Supply Recommendations

Connect a low output impedance power supply directly to the INPUT pin of the TLV700. Inductive impedances between the input supply and the INPUT pin can create significant voltage excursions at the INPUT pin during start-up or load transient events.

10 Layout

10.1 Layout Guidelines

Input and output capacitors should be placed as close to the device pins as possible. To improve AC performance such as PSRR, output noise, and transient response, TI recommends designing the printed-circuit-boards with separate ground planes for V_{IN} and V_{OUT} , with the ground plane connected only at the GND pin of the device. In addition, the ground connection for the output capacitor should be connected directly to the GND pin of the device. High ESR capacitors may degrade PSRR performance.

10.2 Layout Examples



Figure 24. Layout Example for the DCK and DDC Package

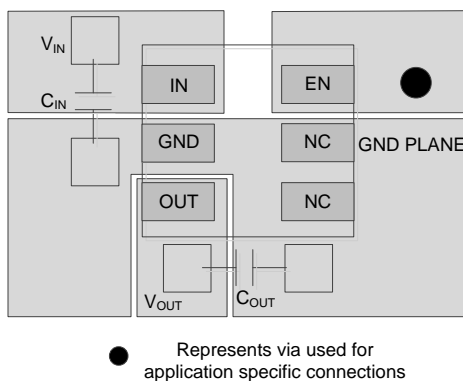

Figure 25. Layout Example for the DSE Package

10.3 Thermal Protection

Thermal protection disables the output when the junction temperature rises to approximately 160°C, allowing the device to cool. When the junction temperature cools to approximately 140°C, the output circuitry is again enabled. Depending on power dissipation, thermal resistance, and ambient temperature, the thermal protection circuit may cycle on and off. This cycling limits the dissipation of the regulator, protecting it from damage as a result of overheating.

Any tendency to activate the thermal protection circuit indicates excessive power dissipation or an inadequate heatsink. For reliable operation, junction temperature should be limited to 125°C maximum. To estimate the margin of safety in a complete design (including heatsink), increase the ambient temperature until the thermal protection is triggered; use worst-case loads and signal conditions.

For good reliability, thermal protection should trigger at least 35°C above the maximum expected ambient condition of the particular application. This configuration produces a worst-case junction temperature of 125°C at the highest expected ambient temperature and worst-case load.

Thermal Protection (continued)

The internal protection circuitry of the TLV700 has been designed to protect against overload conditions. The protection circuitry was not intended to replace proper heatsinking. Continuously running the TLV700 into thermal shutdown degrades device reliability.

10.4 Power Dissipation

The ability to remove heat from the die is different for each package type, presenting different considerations in the PCB layout. The PCB area around the device that is free of other components moves the heat from the device to the ambient air. Performance data for JEDEC low and high-K boards are given in [Thermal Information](#). Using heavier copper increases the effectiveness in removing heat from the device. The addition of plated through-holes to heat-dissipating layers also improves heatsink effectiveness.

Power dissipation depends on input voltage and load conditions. Power dissipation (P_D) is equal to the product of the output current and the voltage drop across the output pass element, as shown in [Equation 1](#).

$$P_D = (V_{IN} - V_{OUT}) \times I_{OUT} \quad (1)$$

11 Device and Documentation Support

11.1 Device Support

11.1.1 Development Support

11.1.1.1 Evaluation Modules

Three evaluation modules (EVMs) are available to assist in the initial circuit performance evaluation using the TLV700:

- [TLV70033EVM-503](#)
- [TLV70018EVM-503](#)
- [TLV70028EVM-463](#)

These EVMs can be requested at the Texas Instruments website through the product folders or purchased directly from [the TI eStore](#).

11.1.1.2 Spice Models

Computer simulation of circuit performance using SPICE is often useful when analyzing the performance of analog circuits and systems. A SPICE model for the TLV700 is available through the product folders under *Tools & Software*.

11.1.2 Device Nomenclature

Table 3. Ordering Information⁽¹⁾

PRODUCT	V _{OUT} ⁽²⁾
TLV700xx yyyz	XX is nominal output voltage (for example, 28 = 2.8 V). YYY is the package designator. Z is tape and reel quantity (R = 3000, T = 250).

(1) For the most current package and ordering information see the Package Option Addendum at the end of this document, or visit the device product folder at www.ti.com.

(2) Output voltages from 1.2 V to 4.8 V in 50-mV increments are available. Contact factory for details and availability.

11.2 Documentation Support

11.2.1 Related Documentation

- *Using the TLV700xxEVM-463 Evaluation Module*, [SLUU390](#)
- *Using the TLV700xxEVM-503 Evaluation Module*, [SLUU391](#)

11.3 Trademarks

Bluetooth is a registered trademark of Bluetooth SIG.

ZigBee is a registered trademark of the ZigBee Alliance.

All other trademarks are the property of their respective owners.

11.4 Electrostatic Discharge Caution



These devices have limited built-in ESD protection. The leads should be shorted together or the device placed in conductive foam during storage or handling to prevent electrostatic damage to the MOS gates.

11.5 Glossary

[SLYZ022](#) — *TI Glossary*.

This glossary lists and explains terms, acronyms, and definitions.

12 Mechanical, Packaging, and Orderable Information

The following pages include mechanical, packaging, and orderable information. This information is the most current data available for the designated devices. This data is subject to change without notice and revision of this document. For browser-based versions of this data sheet, refer to the left-hand navigation.

PACKAGING INFORMATION

Orderable Device	Status (1)	Package Type	Package Drawing	Pins	Package Qty	Eco Plan (2)	Lead finish/ Ball material (6)	MSL Peak Temp (3)	Op Temp (°C)	Device Marking (4/5)	Samples
TLV70012DCKR	ACTIVE	SC70	DCK	5	3000	RoHS & Green	NIPDAU	Level-1-260C-UNLIM	-40 to 125	ODT	Samples
TLV70012DCKT	ACTIVE	SC70	DCK	5	250	RoHS & Green	NIPDAU	Level-1-260C-UNLIM	-40 to 125	ODT	Samples
TLV70012DDCR	ACTIVE	SOT-23-THIN	DDC	5	3000	RoHS & Green	NIPDAU	Level-2-260C-1 YEAR	-40 to 125	ODO	Samples
TLV70012DDCT	ACTIVE	SOT-23-THIN	DDC	5	250	RoHS & Green	NIPDAU	Level-2-260C-1 YEAR	-40 to 125	ODO	Samples
TLV70012DSER	ACTIVE	WSON	DSE	6	3000	RoHS & Green	NIPDAU NIPDAUAG	Level-1-260C-UNLIM	-40 to 125	NH	Samples
TLV70012DSET	ACTIVE	WSON	DSE	6	250	RoHS & Green	NIPDAU NIPDAUAG	Level-1-260C-UNLIM	-40 to 125	NH	Samples
TLV70013DDCR	ACTIVE	SOT-23-THIN	DDC	5	3000	RoHS & Green	NIPDAU	Level-2-260C-1 YEAR	-40 to 125	SAH	Samples
TLV70013DDCT	ACTIVE	SOT-23-THIN	DDC	5	250	RoHS & Green	NIPDAU	Level-2-260C-1 YEAR	-40 to 125	SAH	Samples
TLV70015DCKR	ACTIVE	SC70	DCK	5	3000	RoHS & Green	NIPDAU	Level-1-260C-UNLIM	-40 to 125	ODU	Samples
TLV70015DCKT	ACTIVE	SC70	DCK	5	250	RoHS & Green	NIPDAU	Level-1-260C-UNLIM	-40 to 125	ODU	Samples
TLV70015DDCR	ACTIVE	SOT-23-THIN	DDC	5	3000	RoHS & Green	NIPDAU	Level-2-260C-1 YEAR	-40 to 125	ODP	Samples
TLV70015DDCT	ACTIVE	SOT-23-THIN	DDC	5	250	RoHS & Green	NIPDAU	Level-2-260C-1 YEAR	-40 to 125	ODP	Samples
TLV70015DSER	ACTIVE	WSON	DSE	6	3000	RoHS & Green	NIPDAU NIPDAUAG	Level-1-260C-UNLIM	-40 to 125	NJ	Samples
TLV70015DSET	ACTIVE	WSON	DSE	6	250	RoHS & Green	NIPDAU NIPDAUAG	Level-1-260C-UNLIM	-40 to 125	NJ	Samples
TLV70018DCKR	ACTIVE	SC70	DCK	5	3000	RoHS & Green	NIPDAU	Level-1-260C-UNLIM	-40 to 125	ODV	Samples
TLV70018DCKT	ACTIVE	SC70	DCK	5	250	RoHS & Green	NIPDAU	Level-1-260C-UNLIM	-40 to 125	ODV	Samples
TLV70018DDCR	ACTIVE	SOT-23-THIN	DDC	5	3000	RoHS & Green	NIPDAU SN	Level-2-260C-1 YEAR	-40 to 125	ODK	Samples
TLV70018DDCT	ACTIVE	SOT-23-THIN	DDC	5	250	RoHS & Green	NIPDAU SN	Level-2-260C-1 YEAR	-40 to 125	ODK	Samples
TLV70018DSER	ACTIVE	WSON	DSE	6	3000	RoHS & Green	NIPDAU NIPDAUAG	Level-1-260C-UNLIM	-40 to 125	NK	Samples
TLV70018DSET	ACTIVE	WSON	DSE	6	250	RoHS & Green	NIPDAU NIPDAUAG	Level-1-260C-UNLIM	-40 to 85	NK	Samples

Orderable Device	Status (1)	Package Type	Package Drawing	Pins	Package Qty	Eco Plan (2)	Lead finish/ Ball material (6)	MSL Peak Temp (3)	Op Temp (°C)	Device Marking (4/5)	Samples
TLV70019DDCR	ACTIVE	SOT-23-THIN	DDC	5	3000	RoHS & Green	NIPDAU	Level-2-260C-1 YEAR	-40 to 125	SCJ	Samples
TLV70019DDCT	ACTIVE	SOT-23-THIN	DDC	5	250	RoHS & Green	NIPDAU	Level-2-260C-1 YEAR	-40 to 125	SCJ	Samples
TLV70022DDCR	ACTIVE	SOT-23-THIN	DDC	5	3000	RoHS & Green	NIPDAU	Level-2-260C-1 YEAR	-40 to 125	SCI	Samples
TLV70022DDCT	ACTIVE	SOT-23-THIN	DDC	5	250	RoHS & Green	NIPDAU	Level-2-260C-1 YEAR	-40 to 125	SCI	Samples
TLV70025DCKR	ACTIVE	SC70	DCK	5	3000	RoHS & Green	NIPDAU	Level-1-260C-UNLIM	-40 to 125	QTP	Samples
TLV70025DCKT	ACTIVE	SC70	DCK	5	250	RoHS & Green	NIPDAU	Level-1-260C-UNLIM	-40 to 125	QTP	Samples
TLV70025DDCR	ACTIVE	SOT-23-THIN	DDC	5	3000	RoHS & Green	NIPDAU SN	Level-2-260C-1 YEAR	-40 to 125	DAU	Samples
TLV70025DDCT	ACTIVE	SOT-23-THIN	DDC	5	250	RoHS & Green	NIPDAU SN	Level-2-260C-1 YEAR	-40 to 125	DAU	Samples
TLV70025DSER	ACTIVE	WSON	DSE	6	3000	RoHS & Green	NIPDAU NIPDAUAG	Level-1-260C-UNLIM	-40 to 125	QY	Samples
TLV70025DSET	ACTIVE	WSON	DSE	6	250	RoHS & Green	NIPDAU NIPDAUAG	Level-1-260C-UNLIM	-40 to 125	QY	Samples
TLV70028DCKR	ACTIVE	SC70	DCK	5	3000	RoHS & Green	NIPDAU	Level-1-260C-UNLIM	-40 to 125	ODW	Samples
TLV70028DCKT	ACTIVE	SC70	DCK	5	250	RoHS & Green	NIPDAU	Level-1-260C-UNLIM	-40 to 125	ODW	Samples
TLV70028DDCR	ACTIVE	SOT-23-THIN	DDC	5	3000	RoHS & Green	NIPDAU SN	Level-2-260C-1 YEAR	-40 to 125	ODL	Samples
TLV70028DDCT	ACTIVE	SOT-23-THIN	DDC	5	250	RoHS & Green	NIPDAU SN	Level-2-260C-1 YEAR	-40 to 125	ODL	Samples
TLV70028DSER	ACTIVE	WSON	DSE	6	3000	RoHS & Green	NIPDAU NIPDAUAG	Level-1-260C-UNLIM	-40 to 125	NL	Samples
TLV70028DSET	ACTIVE	WSON	DSE	6	250	RoHS & Green	NIPDAU NIPDAUAG	Level-1-260C-UNLIM	-40 to 125	NL	Samples
TLV70029DSER	ACTIVE	WSON	DSE	6	3000	RoHS & Green	NIPDAUAG	Level-1-260C-UNLIM	-40 to 125	QJ	Samples
TLV70029DSET	ACTIVE	WSON	DSE	6	250	RoHS & Green	NIPDAUAG	Level-1-260C-UNLIM	-40 to 125	QJ	Samples
TLV70030DCKR	ACTIVE	SC70	DCK	5	3000	RoHS & Green	NIPDAU	Level-1-260C-UNLIM	-40 to 125	ODR	Samples
TLV70030DCKT	ACTIVE	SC70	DCK	5	250	RoHS & Green	NIPDAU	Level-1-260C-UNLIM	-40 to 125	ODR	Samples
TLV70030DDCR	ACTIVE	SOT-23-THIN	DDC	5	3000	RoHS & Green	NIPDAU SN	Level-2-260C-1 YEAR	-40 to 125	ODM	Samples

Orderable Device	Status (1)	Package Type	Package Drawing	Pins	Package Qty	Eco Plan (2)	Lead finish/ Ball material (6)	MSL Peak Temp (3)	Op Temp (°C)	Device Marking (4/5)	Samples
TLV70030DDCT	ACTIVE	SOT-23-THIN	DDC	5	250	RoHS & Green	NIPDAU SN	Level-2-260C-1 YEAR	-40 to 125	ODM	Samples
TLV70030DSER	ACTIVE	WSON	DSE	6	3000	RoHS & Green	NIPDAU NIPDAUAG	Level-1-260C-UNLIM	-40 to 125	NP	Samples
TLV70030DSET	ACTIVE	WSON	DSE	6	250	RoHS & Green	NIPDAU NIPDAUAG	Level-1-260C-UNLIM	-40 to 125	NP	Samples
TLV70031DSER	ACTIVE	WSON	DSE	6	3000	RoHS & Green	NIPDAUAG	Level-1-260C-UNLIM	-40 to 125	C4	Samples
TLV70031DSET	ACTIVE	WSON	DSE	6	250	RoHS & Green	NIPDAUAG	Level-1-260C-UNLIM	-40 to 125	C4	Samples
TLV70032DDCR	ACTIVE	SOT-23-THIN	DDC	5	3000	RoHS & Green	NIPDAU	Level-2-260C-1 YEAR	-40 to 125	SCH	Samples
TLV70032DDCT	ACTIVE	SOT-23-THIN	DDC	5	250	RoHS & Green	NIPDAU	Level-2-260C-1 YEAR	-40 to 125	SCH	Samples
TLV70033DCKR	ACTIVE	SC70	DCK	5	3000	RoHS & Green	NIPDAU	Level-1-260C-UNLIM	-40 to 125	ODS	Samples
TLV70033DCKT	ACTIVE	SC70	DCK	5	250	RoHS & Green	NIPDAU	Level-1-260C-UNLIM	-40 to 125	ODS	Samples
TLV70033DDCR	ACTIVE	SOT-23-THIN	DDC	5	3000	RoHS & Green	NIPDAU SN	Level-2-260C-1 YEAR	-40 to 125	ODN	Samples
TLV70033DDCT	ACTIVE	SOT-23-THIN	DDC	5	250	RoHS & Green	NIPDAU SN	Level-2-260C-1 YEAR	-40 to 125	ODN	Samples
TLV70033DSER	ACTIVE	WSON	DSE	6	3000	RoHS & Green	NIPDAU NIPDAUAG	Level-1-260C-UNLIM	-40 to 125	NR	Samples
TLV70033DSET	ACTIVE	WSON	DSE	6	250	RoHS & Green	NIPDAU NIPDAUAG	Level-1-260C-UNLIM	-40 to 125	NR	Samples
TLV70036DDCR	ACTIVE	SOT-23-THIN	DDC	5	3000	RoHS & Green	NIPDAU	Level-2-260C-1 YEAR	-40 to 125	SCG	Samples
TLV70036DDCT	ACTIVE	SOT-23-THIN	DDC	5	250	RoHS & Green	NIPDAU	Level-2-260C-1 YEAR	-40 to 125	SCG	Samples
TLV70036DSER	ACTIVE	WSON	DSE	6	3000	RoHS & Green	NIPDAUAG	Level-1-260C-UNLIM	-40 to 125	UG	Samples
TLV70036DSET	ACTIVE	WSON	DSE	6	250	RoHS & Green	NIPDAUAG	Level-1-260C-UNLIM	-40 to 125	UG	Samples

(1) The marketing status values are defined as follows:

ACTIVE: Product device recommended for new designs.

LIFEBUY: TI has announced that the device will be discontinued, and a lifetime-buy period is in effect.

NRND: Not recommended for new designs. Device is in production to support existing customers, but TI does not recommend using this part in a new design.

PREVIEW: Device has been announced but is not in production. Samples may or may not be available.

OBSOLETE: TI has discontinued the production of the device.

(2) **RoHS:** TI defines "RoHS" to mean semiconductor products that are compliant with the current EU RoHS requirements for all 10 RoHS substances, including the requirement that RoHS substance do not exceed 0.1% by weight in homogeneous materials. Where designed to be soldered at high temperatures, "RoHS" products are suitable for use in specified lead-free processes. TI may reference these types of products as "Pb-Free".

RoHS Exempt: TI defines "RoHS Exempt" to mean products that contain lead but are compliant with EU RoHS pursuant to a specific EU RoHS exemption.

Green: TI defines "Green" to mean the content of Chlorine (Cl) and Bromine (Br) based flame retardants meet JS709B low halogen requirements of ≤ 1000 ppm threshold. Antimony trioxide based flame retardants must also meet the ≤ 1000 ppm threshold requirement.

(3) MSL, Peak Temp. - The Moisture Sensitivity Level rating according to the JEDEC industry standard classifications, and peak solder temperature.

(4) There may be additional marking, which relates to the logo, the lot trace code information, or the environmental category on the device.

(5) Multiple Device Markings will be inside parentheses. Only one Device Marking contained in parentheses and separated by a "~" will appear on a device. If a line is indented then it is a continuation of the previous line and the two combined represent the entire Device Marking for that device.

(6) Lead finish/Ball material - Orderable Devices may have multiple material finish options. Finish options are separated by a vertical ruled line. Lead finish/Ball material values may wrap to two lines if the finish value exceeds the maximum column width.

Important Information and Disclaimer:The information provided on this page represents TI's knowledge and belief as of the date that it is provided. TI bases its knowledge and belief on information provided by third parties, and makes no representation or warranty as to the accuracy of such information. Efforts are underway to better integrate information from third parties. TI has taken and continues to take reasonable steps to provide representative and accurate information but may not have conducted destructive testing or chemical analysis on incoming materials and chemicals. TI and TI suppliers consider certain information to be proprietary, and thus CAS numbers and other limited information may not be available for release.

In no event shall TI's liability arising out of such information exceed the total purchase price of the TI part(s) at issue in this document sold by TI to Customer on an annual basis.

OTHER QUALIFIED VERSIONS OF TLV700 :

- Automotive : [TLV700-Q1](#)

NOTE: Qualified Version Definitions:

- Automotive - Q100 devices qualified for high-reliability automotive applications targeting zero defects

TAPE AND REEL INFORMATION

QUADRANT ASSIGNMENTS FOR PIN 1 ORIENTATION IN TAPE

*All dimensions are nominal

Device	Package Type	Package Drawing	Pins	SPQ	Reel Diameter (mm)	Reel Width W1 (mm)	A0 (mm)	B0 (mm)	K0 (mm)	P1 (mm)	W (mm)	Pin1 Quadrant
TLV70012DCKR	SC70	DCK	5	3000	178.0	9.0	2.4	2.5	1.2	4.0	8.0	Q3
TLV70012DCKR	SC70	DCK	5	3000	180.0	8.4	2.47	2.3	1.25	4.0	8.0	Q3
TLV70012DCKT	SC70	DCK	5	250	180.0	8.4	2.47	2.3	1.25	4.0	8.0	Q3
TLV70012DCKT	SC70	DCK	5	250	178.0	9.0	2.4	2.5	1.2	4.0	8.0	Q3
TLV70012DDCR	SOT-23-THIN	DDC	5	3000	179.0	8.4	3.2	3.2	1.4	4.0	8.0	Q3
TLV70012DDCR	SOT-23-THIN	DDC	5	3000	180.0	8.4	3.1	3.05	1.1	4.0	8.0	Q3
TLV70012DDCT	SOT-23-THIN	DDC	5	250	180.0	8.4	3.1	3.05	1.1	4.0	8.0	Q3
TLV70012DDCT	SOT-23-THIN	DDC	5	250	179.0	8.4	3.2	3.2	1.4	4.0	8.0	Q3
TLV70012DSER	WSON	DSE	6	3000	180.0	8.4	1.83	1.83	0.89	4.0	8.0	Q2
TLV70012DSET	WSON	DSE	6	250	180.0	8.4	1.83	1.83	0.89	4.0	8.0	Q2
TLV70013DDCR	SOT-23-THIN	DDC	5	3000	180.0	8.4	3.1	3.05	1.1	4.0	8.0	Q3
TLV70013DDCT	SOT-23-THIN	DDC	5	250	180.0	8.4	3.1	3.05	1.1	4.0	8.0	Q3

Device	Package Type	Package Drawing	Pins	SPQ	Reel Diameter (mm)	Reel Width W1 (mm)	A0 (mm)	B0 (mm)	K0 (mm)	P1 (mm)	W (mm)	Pin1 Quadrant
TLV70015DCKR	SC70	DCK	5	3000	180.0	8.4	2.47	2.3	1.25	4.0	8.0	Q3
TLV70015DCKR	SC70	DCK	5	3000	178.0	9.0	2.4	2.5	1.2	4.0	8.0	Q3
TLV70015DCKT	SC70	DCK	5	250	178.0	9.0	2.4	2.5	1.2	4.0	8.0	Q3
TLV70015DCKT	SC70	DCK	5	250	180.0	8.4	2.47	2.3	1.25	4.0	8.0	Q3
TLV70015DDCR	SOT-23-THIN	DDC	5	3000	180.0	8.4	3.1	3.05	1.1	4.0	8.0	Q3
TLV70015DDCR	SOT-23-THIN	DDC	5	3000	180.0	8.4	3.2	3.2	1.4	4.0	8.0	Q3
TLV70015DDCT	SOT-23-THIN	DDC	5	250	179.0	8.4	3.2	3.2	1.4	4.0	8.0	Q3
TLV70015DDCT	SOT-23-THIN	DDC	5	250	180.0	8.4	3.1	3.05	1.1	4.0	8.0	Q3
TLV70015DSER	WSO	DSE	6	3000	180.0	8.4	1.83	1.83	0.89	4.0	8.0	Q2
TLV70015DSET	WSO	DSE	6	250	180.0	8.4	1.83	1.83	0.89	4.0	8.0	Q2
TLV70018DCKR	SC70	DCK	5	3000	178.0	9.0	2.4	2.5	1.2	4.0	8.0	Q3
TLV70018DCKR	SC70	DCK	5	3000	180.0	8.4	2.47	2.3	1.25	4.0	8.0	Q3
TLV70018DCKT	SC70	DCK	5	250	178.0	9.0	2.4	2.5	1.2	4.0	8.0	Q3
TLV70018DCKT	SC70	DCK	5	250	180.0	8.4	2.47	2.3	1.25	4.0	8.0	Q3
TLV70018DDCR	SOT-23-THIN	DDC	5	3000	180.0	8.4	3.2	3.2	1.4	4.0	8.0	Q3
TLV70018DDCT	SOT-23-THIN	DDC	5	250	180.0	8.4	3.2	3.2	1.4	4.0	8.0	Q3
TLV70018DSER	WSO	DSE	6	3000	179.0	8.4	1.8	1.8	1.0	4.0	8.0	Q2
TLV70018DSER	WSO	DSE	6	3000	180.0	8.4	1.83	1.83	0.89	4.0	8.0	Q2
TLV70018DSET	WSO	DSE	6	250	180.0	8.4	1.83	1.83	0.89	4.0	8.0	Q2
TLV70019DDCR	SOT-23-THIN	DDC	5	3000	179.0	8.4	3.2	3.2	1.4	4.0	8.0	Q3
TLV70019DDCT	SOT-23-THIN	DDC	5	250	179.0	8.4	3.2	3.2	1.4	4.0	8.0	Q3
TLV70022DDCR	SOT-23-THIN	DDC	5	3000	179.0	8.4	3.2	3.2	1.4	4.0	8.0	Q3
TLV70022DDCT	SOT-23-THIN	DDC	5	250	179.0	8.4	3.2	3.2	1.4	4.0	8.0	Q3
TLV70025DCKR	SC70	DCK	5	3000	179.0	8.4	2.2	2.5	1.2	4.0	8.0	Q3
TLV70025DCKR	SC70	DCK	5	3000	178.0	9.0	2.4	2.5	1.2	4.0	8.0	Q3
TLV70025DCKT	SC70	DCK	5	250	178.0	9.0	2.4	2.5	1.2	4.0	8.0	Q3
TLV70025DCKT	SC70	DCK	5	250	179.0	8.4	2.2	2.5	1.2	4.0	8.0	Q3
TLV70025DDCR	SOT-23-THIN	DDC	5	3000	180.0	8.4	3.2	3.2	1.4	4.0	8.0	Q3
TLV70025DDCT	SOT-23-THIN	DDC	5	250	180.0	8.4	3.2	3.2	1.4	4.0	8.0	Q3
TLV70025DSER	WSO	DSE	6	3000	180.0	8.4	1.83	1.83	0.89	4.0	8.0	Q2
TLV70025DSER	WSO	DSE	6	3000	179.0	8.4	1.8	1.8	1.0	4.0	8.0	Q2
TLV70025DSET	WSO	DSE	6	250	179.0	8.4	1.8	1.8	1.0	4.0	8.0	Q2
TLV70025DSET	WSO	DSE	6	250	180.0	8.4	1.83	1.83	0.89	4.0	8.0	Q2

Device	Package Type	Package Drawing	Pins	SPQ	Reel Diameter (mm)	Reel Width W1 (mm)	A0 (mm)	B0 (mm)	K0 (mm)	P1 (mm)	W (mm)	Pin1 Quadrant
TLV70028DCKR	SC70	DCK	5	3000	180.0	8.4	2.47	2.3	1.25	4.0	8.0	Q3
TLV70028DCKR	SC70	DCK	5	3000	178.0	9.0	2.4	2.5	1.2	4.0	8.0	Q3
TLV70028DCKT	SC70	DCK	5	250	180.0	8.4	2.47	2.3	1.25	4.0	8.0	Q3
TLV70028DCKT	SC70	DCK	5	250	178.0	9.0	2.4	2.5	1.2	4.0	8.0	Q3
TLV70028DDCR	SOT-23-THIN	DDC	5	3000	180.0	8.4	3.2	3.2	1.4	4.0	8.0	Q3
TLV70028DDCT	SOT-23-THIN	DDC	5	250	180.0	8.4	3.2	3.2	1.4	4.0	8.0	Q3
TLV70028DSER	WSO	DSE	6	3000	180.0	8.4	1.83	1.83	0.89	4.0	8.0	Q2
TLV70028DSER	WSO	DSE	6	3000	178.0	8.4	1.7	1.7	0.95	4.0	8.0	Q2
TLV70028DSET	WSO	DSE	6	250	178.0	8.4	1.7	1.7	0.95	4.0	8.0	Q2
TLV70028DSET	WSO	DSE	6	250	180.0	8.4	1.83	1.83	0.89	4.0	8.0	Q2
TLV70029DSER	WSO	DSE	6	3000	180.0	8.4	1.83	1.83	0.89	4.0	8.0	Q2
TLV70029DSET	WSO	DSE	6	250	180.0	8.4	1.83	1.83	0.89	4.0	8.0	Q2
TLV70030DCKR	SC70	DCK	5	3000	178.0	9.0	2.4	2.5	1.2	4.0	8.0	Q3
TLV70030DCKR	SC70	DCK	5	3000	180.0	8.4	2.47	2.3	1.25	4.0	8.0	Q3
TLV70030DCKR	SC70	DCK	5	3000	179.0	8.4	2.2	2.5	1.2	4.0	8.0	Q3
TLV70030DCKT	SC70	DCK	5	250	180.0	8.4	2.47	2.3	1.25	4.0	8.0	Q3
TLV70030DCKT	SC70	DCK	5	250	178.0	9.0	2.4	2.5	1.2	4.0	8.0	Q3
TLV70030DCKT	SC70	DCK	5	250	179.0	8.4	2.2	2.5	1.2	4.0	8.0	Q3
TLV70030DDCR	SOT-23-THIN	DDC	5	3000	180.0	8.4	3.2	3.2	1.4	4.0	8.0	Q3
TLV70030DDCT	SOT-23-THIN	DDC	5	250	180.0	8.4	3.2	3.2	1.4	4.0	8.0	Q3
TLV70030DSER	WSO	DSE	6	3000	180.0	8.4	1.83	1.83	0.89	4.0	8.0	Q2
TLV70030DSET	WSO	DSE	6	250	180.0	8.4	1.83	1.83	0.89	4.0	8.0	Q2
TLV70031DSER	WSO	DSE	6	3000	180.0	8.4	1.83	1.83	0.89	4.0	8.0	Q2
TLV70031DSET	WSO	DSE	6	250	180.0	8.4	1.83	1.83	0.89	4.0	8.0	Q2
TLV70032DDCR	SOT-23-THIN	DDC	5	3000	180.0	8.4	3.1	3.05	1.1	4.0	8.0	Q3
TLV70032DDCT	SOT-23-THIN	DDC	5	250	180.0	8.4	3.1	3.05	1.1	4.0	8.0	Q3
TLV70033DCKR	SC70	DCK	5	3000	180.0	8.4	2.47	2.3	1.25	4.0	8.0	Q3
TLV70033DCKR	SC70	DCK	5	3000	178.0	9.0	2.4	2.5	1.2	4.0	8.0	Q3
TLV70033DCKT	SC70	DCK	5	250	180.0	8.4	2.47	2.3	1.25	4.0	8.0	Q3
TLV70033DCKT	SC70	DCK	5	250	178.0	9.0	2.4	2.5	1.2	4.0	8.0	Q3
TLV70033DDCR	SOT-23-THIN	DDC	5	3000	180.0	8.4	3.2	3.2	1.4	4.0	8.0	Q3
TLV70033DDCT	SOT-23-THIN	DDC	5	250	180.0	8.4	3.2	3.2	1.4	4.0	8.0	Q3
TLV70033DSER	WSO	DSE	6	3000	178.0	8.4	1.7	1.7	0.95	4.0	8.0	Q2
TLV70033DSER	WSO	DSE	6	3000	180.0	8.4	1.83	1.83	0.89	4.0	8.0	Q2
TLV70033DSET	WSO	DSE	6	250	180.0	8.4	1.83	1.83	0.89	4.0	8.0	Q2
TLV70033DSET	WSO	DSE	6	250	178.0	8.4	1.7	1.7	0.95	4.0	8.0	Q2

Device	Package Type	Package Drawing	Pins	SPQ	Reel Diameter (mm)	Reel Width W1 (mm)	A0 (mm)	B0 (mm)	K0 (mm)	P1 (mm)	W (mm)	Pin1 Quadrant
TLV70036DDCR	SOT-23-THIN	DDC	5	3000	180.0	8.4	3.1	3.05	1.1	4.0	8.0	Q3
TLV70036DDCT	SOT-23-THIN	DDC	5	250	180.0	8.4	3.1	3.05	1.1	4.0	8.0	Q3
TLV70036DSE	WSON	DSE	6	3000	180.0	8.4	1.83	1.83	0.89	4.0	8.0	Q2
TLV70036DSET	WSON	DSE	6	250	180.0	8.4	1.83	1.83	0.89	4.0	8.0	Q2

TAPE AND REEL BOX DIMENSIONS



*All dimensions are nominal

Device	Package Type	Package Drawing	Pins	SPQ	Length (mm)	Width (mm)	Height (mm)
TLV70012DCKR	SC70	DCK	5	3000	180.0	180.0	18.0
TLV70012DCKR	SC70	DCK	5	3000	183.0	183.0	20.0
TLV70012DCKT	SC70	DCK	5	250	183.0	183.0	20.0
TLV70012DCKT	SC70	DCK	5	250	180.0	180.0	18.0
TLV70012DDCR	SOT-23-THIN	DDC	5	3000	213.0	191.0	35.0
TLV70012DDCR	SOT-23-THIN	DDC	5	3000	406.0	348.0	63.0
TLV70012DDCT	SOT-23-THIN	DDC	5	250	202.0	201.0	28.0
TLV70012DDCT	SOT-23-THIN	DDC	5	250	213.0	191.0	35.0
TLV70012DSER	WSON	DSE	6	3000	183.0	183.0	20.0
TLV70012DSET	WSON	DSE	6	250	183.0	183.0	20.0
TLV70013DDCR	SOT-23-THIN	DDC	5	3000	202.0	201.0	28.0
TLV70013DDCT	SOT-23-THIN	DDC	5	250	213.0	191.0	35.0
TLV70015DCKR	SC70	DCK	5	3000	183.0	183.0	20.0
TLV70015DCKR	SC70	DCK	5	3000	180.0	180.0	18.0
TLV70015DCKT	SC70	DCK	5	250	180.0	180.0	18.0
TLV70015DCKT	SC70	DCK	5	250	183.0	183.0	20.0
TLV70015DDCR	SOT-23-THIN	DDC	5	3000	213.0	191.0	35.0
TLV70015DDCR	SOT-23-THIN	DDC	5	3000	213.0	191.0	35.0

Device	Package Type	Package Drawing	Pins	SPQ	Length (mm)	Width (mm)	Height (mm)
TLV70015DDCT	SOT-23-THIN	DDC	5	250	213.0	191.0	35.0
TLV70015DDCT	SOT-23-THIN	DDC	5	250	213.0	191.0	35.0
TLV70015DSER	WSON	DSE	6	3000	183.0	183.0	20.0
TLV70015DSET	WSON	DSE	6	250	183.0	183.0	20.0
TLV70018DCKR	SC70	DCK	5	3000	180.0	180.0	18.0
TLV70018DCKR	SC70	DCK	5	3000	183.0	183.0	20.0
TLV70018DCKT	SC70	DCK	5	250	180.0	180.0	18.0
TLV70018DCKT	SC70	DCK	5	250	183.0	183.0	20.0
TLV70018DDCR	SOT-23-THIN	DDC	5	3000	210.0	185.0	35.0
TLV70018DDCT	SOT-23-THIN	DDC	5	250	210.0	185.0	35.0
TLV70018DSER	WSON	DSE	6	3000	200.0	183.0	25.0
TLV70018DSER	WSON	DSE	6	3000	183.0	183.0	20.0
TLV70018DSET	WSON	DSE	6	250	183.0	183.0	20.0
TLV70019DDCR	SOT-23-THIN	DDC	5	3000	213.0	191.0	35.0
TLV70019DDCT	SOT-23-THIN	DDC	5	250	213.0	191.0	35.0
TLV70022DDCR	SOT-23-THIN	DDC	5	3000	213.0	191.0	35.0
TLV70022DDCT	SOT-23-THIN	DDC	5	250	213.0	191.0	35.0
TLV70025DCKR	SC70	DCK	5	3000	200.0	183.0	25.0
TLV70025DCKR	SC70	DCK	5	3000	180.0	180.0	18.0
TLV70025DCKT	SC70	DCK	5	250	180.0	180.0	18.0
TLV70025DCKT	SC70	DCK	5	250	203.0	203.0	35.0
TLV70025DDCR	SOT-23-THIN	DDC	5	3000	210.0	185.0	35.0
TLV70025DDCT	SOT-23-THIN	DDC	5	250	210.0	185.0	35.0
TLV70025DSER	WSON	DSE	6	3000	183.0	183.0	20.0
TLV70025DSER	WSON	DSE	6	3000	203.0	203.0	35.0
TLV70025DSET	WSON	DSE	6	250	203.0	203.0	35.0
TLV70025DSET	WSON	DSE	6	250	183.0	183.0	20.0
TLV70028DCKR	SC70	DCK	5	3000	183.0	183.0	20.0
TLV70028DCKR	SC70	DCK	5	3000	180.0	180.0	18.0
TLV70028DCKT	SC70	DCK	5	250	183.0	183.0	20.0
TLV70028DCKT	SC70	DCK	5	250	180.0	180.0	18.0
TLV70028DDCR	SOT-23-THIN	DDC	5	3000	210.0	185.0	35.0
TLV70028DDCT	SOT-23-THIN	DDC	5	250	210.0	185.0	35.0
TLV70028DSER	WSON	DSE	6	3000	183.0	183.0	20.0
TLV70028DSER	WSON	DSE	6	3000	205.0	200.0	33.0
TLV70028DSET	WSON	DSE	6	250	205.0	200.0	33.0
TLV70028DSET	WSON	DSE	6	250	183.0	183.0	20.0
TLV70029DSER	WSON	DSE	6	3000	183.0	183.0	20.0
TLV70029DSET	WSON	DSE	6	250	183.0	183.0	20.0
TLV70030DCKR	SC70	DCK	5	3000	180.0	180.0	18.0
TLV70030DCKR	SC70	DCK	5	3000	183.0	183.0	20.0
TLV70030DCKR	SC70	DCK	5	3000	200.0	183.0	25.0
TLV70030DCKT	SC70	DCK	5	250	183.0	183.0	20.0

Device	Package Type	Package Drawing	Pins	SPQ	Length (mm)	Width (mm)	Height (mm)
TLV70030DCKT	SC70	DCK	5	250	180.0	180.0	18.0
TLV70030DCKT	SC70	DCK	5	250	203.0	203.0	35.0
TLV70030DDCR	SOT-23-THIN	DDC	5	3000	210.0	185.0	35.0
TLV70030DDCT	SOT-23-THIN	DDC	5	250	210.0	185.0	35.0
TLV70030DSER	WSON	DSE	6	3000	183.0	183.0	20.0
TLV70030DSET	WSON	DSE	6	250	183.0	183.0	20.0
TLV70031DSER	WSON	DSE	6	3000	183.0	183.0	20.0
TLV70031DSET	WSON	DSE	6	250	183.0	183.0	20.0
TLV70032DDCR	SOT-23-THIN	DDC	5	3000	202.0	201.0	28.0
TLV70032DDCT	SOT-23-THIN	DDC	5	250	213.0	191.0	35.0
TLV70033DCKR	SC70	DCK	5	3000	183.0	183.0	20.0
TLV70033DCKR	SC70	DCK	5	3000	180.0	180.0	18.0
TLV70033DCKT	SC70	DCK	5	250	183.0	183.0	20.0
TLV70033DCKT	SC70	DCK	5	250	180.0	180.0	18.0
TLV70033DDCR	SOT-23-THIN	DDC	5	3000	210.0	185.0	35.0
TLV70033DDCT	SOT-23-THIN	DDC	5	250	210.0	185.0	35.0
TLV70033DSER	WSON	DSE	6	3000	205.0	200.0	33.0
TLV70033DSER	WSON	DSE	6	3000	183.0	183.0	20.0
TLV70033DSET	WSON	DSE	6	250	183.0	183.0	20.0
TLV70033DSET	WSON	DSE	6	250	205.0	200.0	33.0
TLV70036DDCR	SOT-23-THIN	DDC	5	3000	202.0	201.0	28.0
TLV70036DDCT	SOT-23-THIN	DDC	5	250	213.0	191.0	35.0
TLV70036DSER	WSON	DSE	6	3000	183.0	183.0	20.0
TLV70036DSET	WSON	DSE	6	250	183.0	183.0	20.0

EXAMPLE BOARD LAYOUT

DDC0005A

SOT-23 - 1.1 max height

SMALL OUTLINE TRANSISTOR

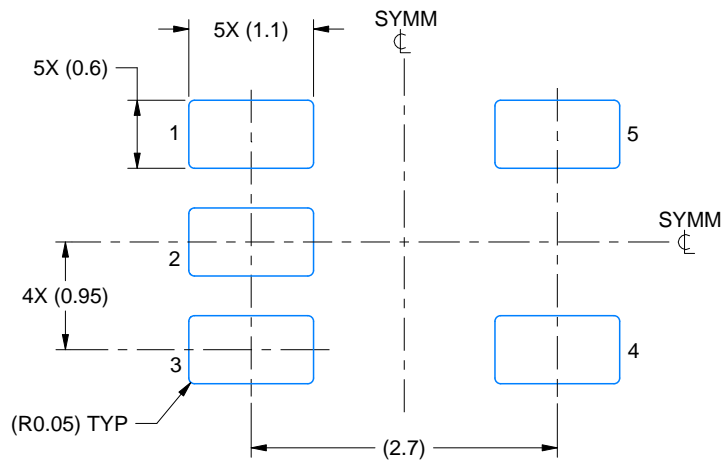

LAND PATTERN EXAMPLE
EXPLODED METAL SHOWN
SCALE:15X

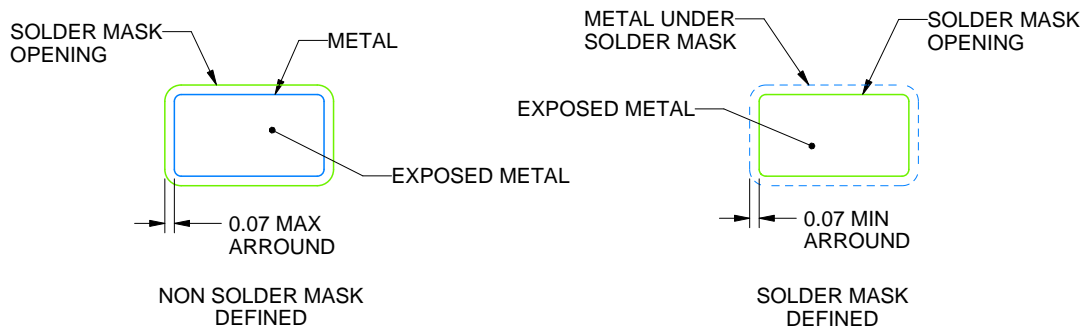

SOLDERMASK DETAILS

4220752/A 03/2023

NOTES: (continued)

- 4. Publication IPC-7351 may have alternate designs.
- 5. Solder mask tolerances between and around signal pads can vary based on board fabrication site.

EXAMPLE STENCIL DESIGN

DDC0005A

SOT-23 - 1.1 max height

SMALL OUTLINE TRANSISTOR

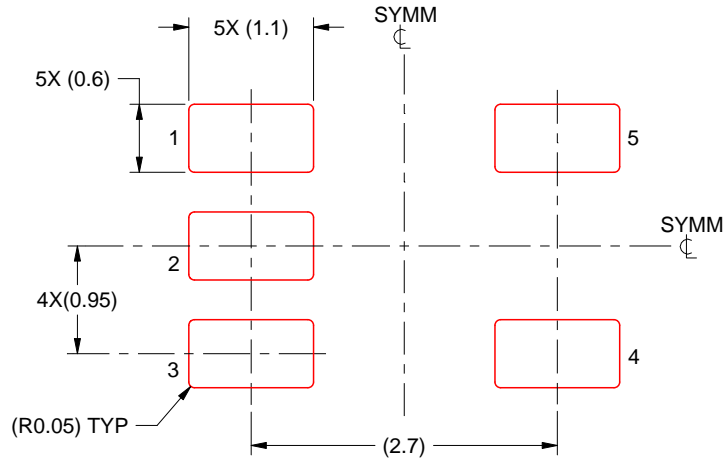

SOLDER PASTE EXAMPLE
BASED ON 0.125 THICK STENCIL
SCALE:15X

4220752/A 03/2023

NOTES: (continued)

6. Laser cutting apertures with trapezoidal walls and rounded corners may offer better paste release. IPC-7525 may have alternate design recommendations.
7. Board assembly site may have different recommendations for stencil design.

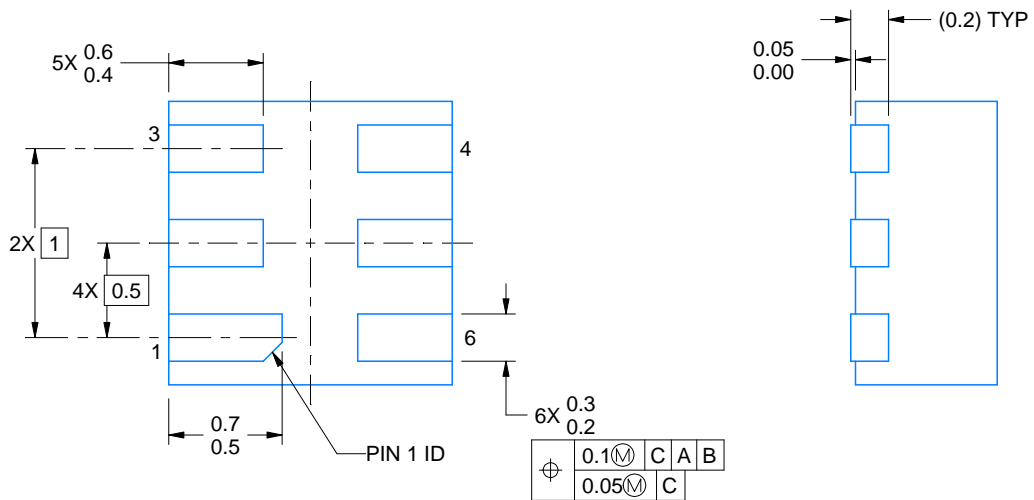
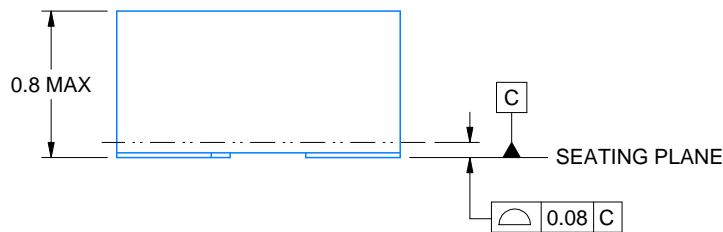
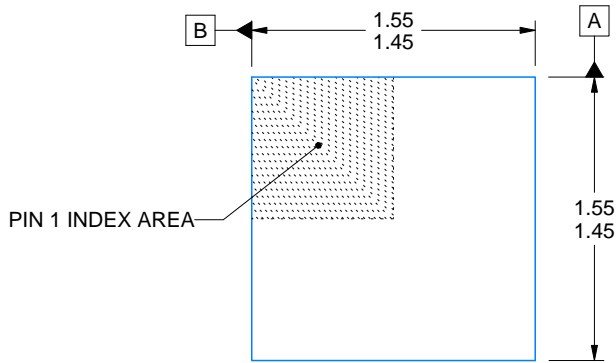

4220552/B 01/2024

NOTES:

1. All linear dimensions are in millimeters. Any dimensions in parenthesis are for reference only. Dimensioning and tolerancing per ASME Y14.5M.
2. This drawing is subject to change without notice.

EXAMPLE BOARD LAYOUT

DSE0006A

WSON - 0.8 mm max height

PLASTIC SMALL OUTLINE - NO LEAD



LAND PATTERN EXAMPLE
SCALE:40X

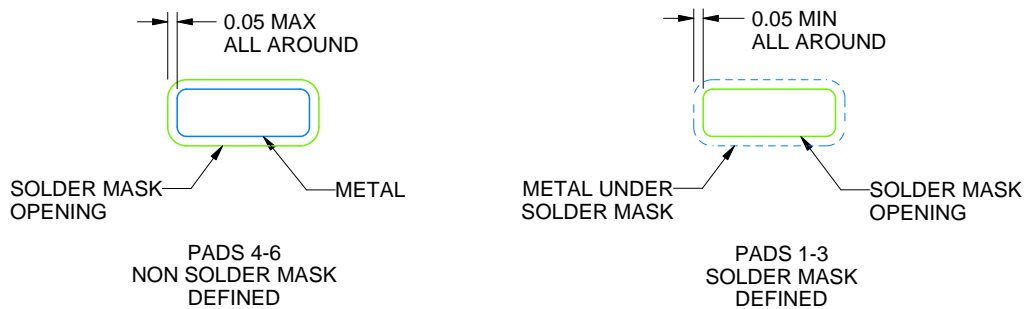

SOLDER MASK DETAILS

4220552/B 01/2024

NOTES: (continued)

3. For more information, see Texas Instruments literature number SLUA271 (www.ti.com/lit/slua271).

EXAMPLE STENCIL DESIGN

DSE0006A

WSON - 0.8 mm max height

PLASTIC SMALL OUTLINE - NO LEAD



SOLDER PASTE EXAMPLE
BASED ON 0.125 mm THICK STENCIL
SCALE:40X

NOTES: (continued)

4. Laser cutting apertures with trapezoidal walls and rounded corners may offer better paste release. IPC-7525 may have alternate design recommendations.

EXAMPLE BOARD LAYOUT

DCK0005A

SOT - 1.1 max height

SMALL OUTLINE TRANSISTOR

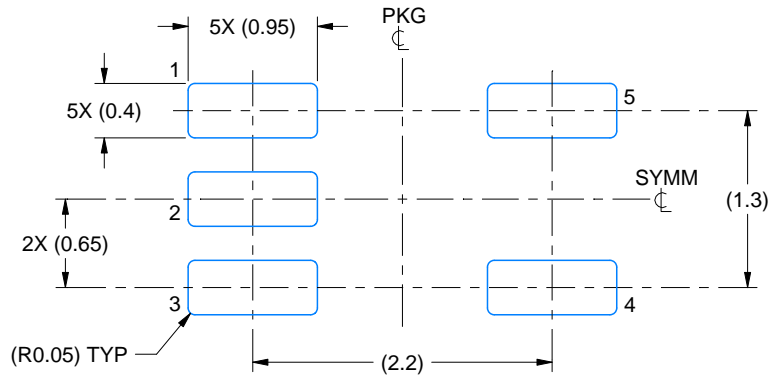

LAND PATTERN EXAMPLE
EXPOSED METAL SHOWN
SCALE:18X

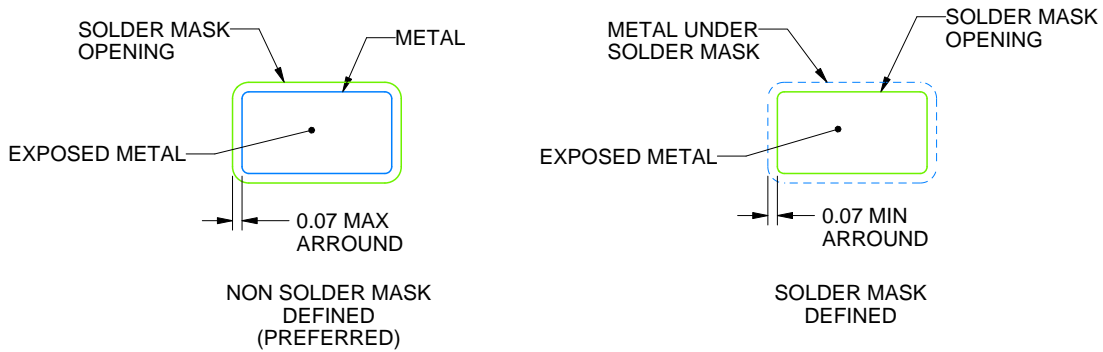

SOLDER MASK DETAILS

4214834/D 07/2023

NOTES: (continued)

6. Publication IPC-7351 may have alternate designs.
7. Solder mask tolerances between and around signal pads can vary based on board fabrication site.

EXAMPLE STENCIL DESIGN

DCK0005A

SOT - 1.1 max height

SMALL OUTLINE TRANSISTOR

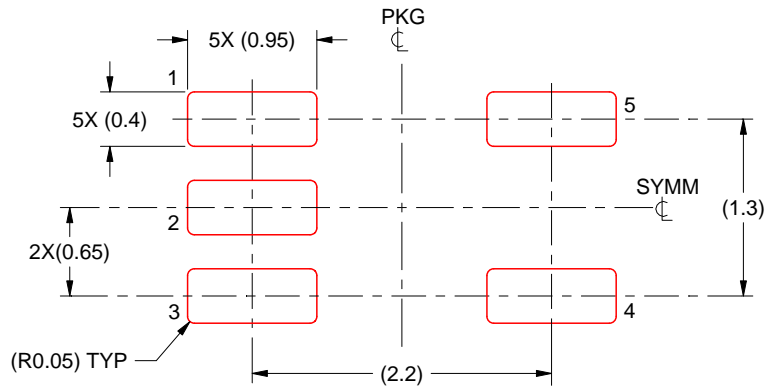

SOLDER PASTE EXAMPLE
BASED ON 0.125 THICK STENCIL
SCALE:18X

4214834/D 07/2023

NOTES: (continued)

8. Laser cutting apertures with trapezoidal walls and rounded corners may offer better paste release. IPC-7525 may have alternate design recommendations.
9. Board assembly site may have different recommendations for stencil design.

IMPORTANT NOTICE AND DISCLAIMER

TI PROVIDES TECHNICAL AND RELIABILITY DATA (INCLUDING DATA SHEETS), DESIGN RESOURCES (INCLUDING REFERENCE DESIGNS), APPLICATION OR OTHER DESIGN ADVICE, WEB TOOLS, SAFETY INFORMATION, AND OTHER RESOURCES "AS IS" AND WITH ALL FAULTS, AND DISCLAIMS ALL WARRANTIES, EXPRESS AND IMPLIED, INCLUDING WITHOUT LIMITATION ANY IMPLIED WARRANTIES OF MERCHANTABILITY, FITNESS FOR A PARTICULAR PURPOSE OR NON-INFRINGEMENT OF THIRD PARTY INTELLECTUAL PROPERTY RIGHTS.

These resources are intended for skilled developers designing with TI products. You are solely responsible for (1) selecting the appropriate TI products for your application, (2) designing, validating and testing your application, and (3) ensuring your application meets applicable standards, and any other safety, security, regulatory or other requirements.

These resources are subject to change without notice. TI grants you permission to use these resources only for development of an application that uses the TI products described in the resource. Other reproduction and display of these resources is prohibited. No license is granted to any other TI intellectual property right or to any third party intellectual property right. TI disclaims responsibility for, and you will fully indemnify TI and its representatives against, any claims, damages, costs, losses, and liabilities arising out of your use of these resources.

TI's products are provided subject to [TI's Terms of Sale](#) or other applicable terms available either on [ti.com](https://www.ti.com) or provided in conjunction with such TI products. TI's provision of these resources does not expand or otherwise alter TI's applicable warranties or warranty disclaimers for TI products.

TI objects to and rejects any additional or different terms you may have proposed.

Mailing Address: Texas Instruments, Post Office Box 655303, Dallas, Texas 75265
Copyright © 2024, Texas Instruments Incorporated

Looking for pricing, stock, or lifecycle information?

Click below to explore more details on WIN SOURCE:

 [View TLV70036DSET](#) on WIN SOURCE

 [Texas Instruments](#) Information

Optimize Your Supply Chain with WIN SOURCE Solutions

-  Global Sourcing Solution
-  Obsolete Management
-  Cost Control Management
-  Shortage Management
-  Alternative Solution
-  Excess Inventory Management