



**THE DATASHEET OF
TPS65632RTET**



TPS65632 Triple-Output AMOLED Display Power Supply

1 Features

- 2.9-V to 4.5-V Input Voltage Range
- Boost Converter 1 (V_{POS})
 - 4.6-V Output Voltage
 - 0.5% Accuracy (25°C to 85°C)
 - Dedicated Output Sense Pin
 - 300-mA Output Current
- Inverting Buck-Boost Converter (V_{NEG})
 - –1.5-V to –5.4-V Programmable Output Voltage
 - –4-V Default Output Voltage
 - 300-mA Output Current
- Boost Converter 2 (AV_{DD})
 - 5.8-V or 7.7-V Output Voltage
 - 30-mA Output Current
- Excellent Line Transient Regulation
- Short-Circuit Protection
- Thermal Shutdown
- 3-mm x 3-mm, 16-Pin WQFN Package

2 Applications

AMOLED Displays

3 Description

The TPS65632 is designed to drive AMOLED displays (Active Matrix Organic Light Emitting Diode) requiring three supply rails, V_{POS} , V_{NEG} and AV_{DD} . The device integrates a boost converter for V_{POS} , an inverting buck-boost converter for V_{NEG} , and a boost converter for AV_{DD} , all of which are suitable for battery operated products. The digital control pin (CTRL) allows programming the negative output voltage in digital steps. The TPS65632 uses a novel technology enabling excellent line and load regulation.

Device Information⁽¹⁾

PART NUMBER	PACKAGE	BODY SIZE (NOM)
TPS65632	WQFN (16)	3.00 mm x 3.00 mm

(1) For all available packages, see the orderable addendum at the end of the datasheet.

Simplified Schematic

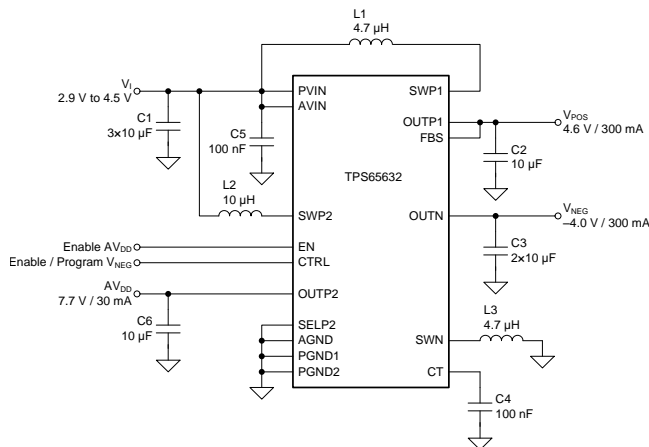

Efficiency vs Output Current

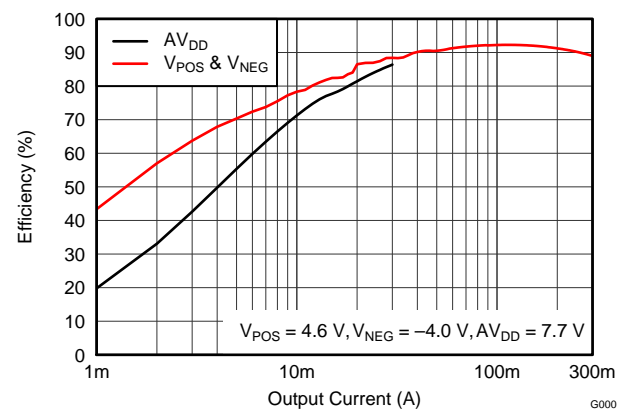

G000



Table of Contents

1 Features	1	7.3 Feature Description	9
2 Applications	1	7.4 Device Functional Modes	12
3 Description	1	8 Application and Implementation	13
4 Revision History	2	8.1 Application Information	13
5 Pin Configuration and Functions	3	8.2 Typical Application	13
6 Specifications	4	9 Power Supply Recommendations	19
6.1 Absolute Maximum Ratings	4	10 Layout	19
6.2 ESD Ratings	4	10.1 Layout Guidelines	19
6.3 Recommended Operating Conditions	4	10.2 Layout Example	19
6.4 Thermal Information	4	11 Device and Documentation Support	20
6.5 Electrical Characteristics	5	11.1 Device Support	20
6.6 Timing Requirements	6	11.2 Trademarks	20
6.7 Typical Characteristics	7	11.3 Electrostatic Discharge Caution	20
7 Detailed Description	8	11.4 Glossary	20
7.1 Overview	8	12 Mechanical, Packaging, and Ordering Information	20
7.2 Functional Block Diagram	8		

4 Revision History

Changes from Original (March 2015) to Revision A

Page

- Changed Load regulation (0.18 TYP) UNIT value in the [Electrical Characteristics](#) From: %/mA To: %/A **6**

5 Pin Configuration and Functions

RTE Package
16-Pin WQFN with Thermal Pad
Top View

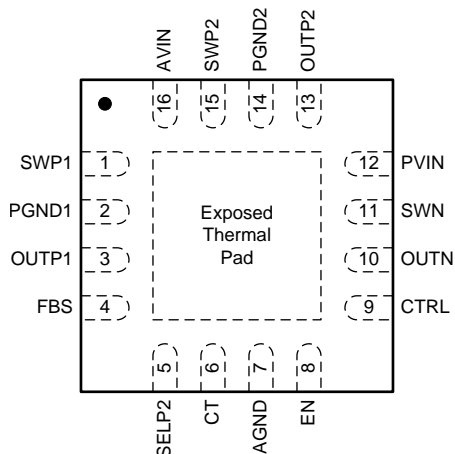

Pin Functions

PIN		TYPE ⁽¹⁾	DESCRIPTION
NAME	NO.		
AGND	7	GND	Analog ground.
AVIN	16	PWR	Supply voltage for the device.
CT	6	I/O	A capacitor connected between this pin and ground sets the transition time for V_{NEG} when programmed to a new value.
CTRL	9	I	Boost converter 1 (V_{POS}) inverting buck-boost converter (V_{NEG}) enable/program.
EN	8	I	Boost converter 2 (AV_{DD}) enable.
FBS	4	I	Boost converter 1 (V_{POS}) sense input.
OUTN	10	O	Inverting buck-boost converter output (V_{NEG}).
OUTP	3	O	Boost converter 1 output (V_{POS}).
OUTP2	13	O	Boost converter 2 output (AV_{DD}).
PGND1	2	GND	Boost converter 1 power ground.
PGND2	14	GND	Boost converter 2 power ground.
PVIN	12	PWR	Inverting buck-boost converter power stage supply voltage.
SELP2	5	I	Boost converter 2 output voltage selection pin. $AV_{DD} = 7.7$ V when SELP2 = low and 5.8 V when SELP2 = high.
SWN	11	I/O	Inverting buck-boost converter switch pin.
SWP1	1	I	Boost converter 1 switch pin.
SWP2	15	I	Boost converter 2 switch pin.
Exposed thermal pad		—	Connect this pad to AGND, PGND1 and PGND2.

(1) GND = Ground, PWR = Power, I = Input, O = Output, I/O = Input/Output

6 Specifications

6.1 Absolute Maximum Ratings

 over operating free-air temperature range (unless otherwise noted)⁽¹⁾

		MIN	MAX	UNIT
Input supply voltage ⁽²⁾	SWP1, OUTP1, FBS, PVIN, AVIN	-0.3	5	V
	SWP2	-0.3	12	V
	OUTP2	-0.3	8.5	V
	OUTN	-6.0	0.3	V
	SWN	-6.5	4.8	V
	CTRL, EN, SELP2	-0.3	5.5	V
	CT	-0.3	3.6	V
Operating virtual junction, T _J		-40	150	°C
Storage temperature, T _{stg}		-65	150	°C

- (1) Stresses beyond those listed under *absolute maximum ratings* may cause permanent damage to the device. These are stress ratings only, and functional operation of the device at these or any other conditions beyond those indicated under *recommended operating conditions* is not implied. Exposure to absolute-maximum-rated conditions for extended periods may affect device reliability.
- (2) With respect to GND pin.

6.2 ESD Ratings

			VALUE	UNIT
V _(ESD)	Electrostatic discharge	Human body model (HBM), per ANSI/ESDA/JEDEC JS-001, all pins ⁽¹⁾	±2000	V
		Charged device model (CDM), per JEDEC specification JESD22-C101, all pins ⁽²⁾	±500	

- (1) JEDEC document JEP155 states that 500-V HBM allows safe manufacturing with a standard ESD control process.
- (2) JEDEC document JEP157 states that 250-V CDM allows safe manufacturing with a standard ESD control process.

6.3 Recommended Operating Conditions

over operating free-air temperature range (unless otherwise noted)

		MIN	NOM	MAX	UNIT
INPUT					
V _I	Input supply voltage range	2.9	3.7	4.5	V
T _J	Operating junction temperature	-40	85	125	°C

6.4 Thermal Information

THERMAL METRIC ⁽¹⁾		RTE [WQFN]	UNIT
		16 PINS	
R _{θJA}	Junction-to-ambient thermal resistance	42.9	°C/W
R _{θJC(top)}	Junction-to-case (top) thermal resistance	44	
R _{θJB}	Junction-to-board thermal resistance	14.2	
ψ _{JT}	Junction-to-top characterization parameter	0.6	
ψ _{JB}	Junction-to-board characterization parameter	14.1	
R _{θJC(bot)}	Junction-to-case (bottom) thermal resistance	3.3	

- (1) For more information about traditional and new thermal metrics, see the *IC Package Thermal Metrics* application report, [SPRA953](#).

6.5 Electrical Characteristics

$V_I = 3.7\text{ V}$, $CTRL = 3.7\text{ V}$, $EN = 3.7\text{ V}$, $V_{POS} = 4.6\text{ V}$, $V_{NEG} = -4.0\text{ V}$, $AV_{DD} = 7.7\text{ V}$, $T_J = -40^\circ\text{C}$ to 85°C , typical values are at $T_J = 25^\circ\text{C}$ (unless otherwise noted)

PARAMETER		TEST CONDITIONS	MIN	TYP	MAX	UNIT
SUPPLY CURRENT AND THERMAL PROTECTION						
V_I	Input voltage range		2.9	3.7	4.5	V
I_{SD}	Shutdown current	$CTRL = GND$, $EN = GND$, sum of current flowing into AVIN and PVIN		0.25	5	μA
V_{UVLO}	Under-voltage lockout threshold	V_I falling	1.8		2.1	V
		V_I rising	2.1		2.5	V
BOOST CONVERTER 1 (V_{POS})						
V_{POS}	Positive output 1 voltage			4.6		V
	Positive output 1 voltage variation	$25^\circ\text{C} \leq T_A \leq 85^\circ\text{C}$, No load	-0.5%		0.5%	
		$-30^\circ\text{C} \leq T_A \leq 85^\circ\text{C}$, No load	-0.8%		0.8%	
$r_{DS(on)1A}$	Switch on-resistance	$I_{(SWP1)} = 200\text{ mA}$		200		m Ω
$r_{DS(on)1B}$	Rectifier on-resistance			350		m Ω
f_{SW1}	Switching frequency	$I_{POS} = 200\text{ mA}$		1.7		MHz
I_{SW1}	Switch current limit	Inductor valley current	0.8	1	1.4	A
V_{SCP1}	Short-circuit threshold in operation	V_{POS} falling	3.95	4.10	4.28	V
t_{SCP1}	Short-circuit detection time in operation			3		ms
V_T	Output voltage sense threshold	$V_{(OUTP1)} - V_{(FBS)}$ increasing	200	300	550	mV
		$V_{(OUTP1)} - V_{(FBS)}$ decreasing	100	200	450	mV
$R_{(FBS)}$	FBS pin pull-down resistance		2	4	6	M Ω
R_{DCHG1}	Discharge resistance	$CTRL = GND$, $I_{(SWP1)} = 1\text{ mA}$	10	30	70	Ω
	Line regulation	$I_{POS} = 200\text{ mA}$		0.01		%/V
	Load regulation	$1\text{ mA} \leq I_{POS} \leq 300\text{ mA}$		0.007		%/A
INVERTING BUCK-BOOST CONVERTER (V_{NEG})						
V_{NEG}	Output voltage default			-4.0		V
	Output voltage range		-1.4		-5.4	
	Output voltage accuracy	$25^\circ\text{C} \leq T_A \leq 85^\circ\text{C}$, no load	-50		50	
$-30^\circ\text{C} \leq T_A \leq 85^\circ\text{C}$, no load		-60		60		
$r_{DS(on)2A}$	SWN MOSFET on-resistance	$I_{(SWN)} = 200\text{ mA}$		200		m Ω
$r_{DS(on)2B}$	SWN MOSFET rectifier on-resistance			300		m Ω
f_{SW2}	SWN Switching frequency	$I_{NEG} = 10\text{ mA}$		1.7		MHz
I_{SW2}	SWN switch current limit	$V_I = 2.9\text{ V}$	1.5	2.2	3	A
V_{SCP2}	Short circuit threshold in operation	Voltage increase from nominal V_{NEG}	300	500	700	mV
	Short circuit threshold in start up		180	200	230	mV
t_{SCP2}	Short circuit detection time in start up			10		ms
	Short circuit detection time in operation			3		ms
R_{DCHG2}	Discharge resistance	$CTRL = GND$, $I_{(SWN)} = 1\text{ mA}$	130	150	170	Ω
	Line regulation	$I_{NEG} = 200\text{ mA}$		0.004		%/V
	Load regulation			0.1		%/A

Electrical Characteristics (continued)

$V_I = 3.7\text{ V}$, $CTRL = 3.7\text{ V}$, $EN = 3.7\text{ V}$, $V_{POS} = 4.6\text{ V}$, $V_{NEG} = -4.0\text{ V}$, $AV_{DD} = 7.7\text{ V}$, $T_J = -40^\circ\text{C}$ to 85°C , typical values are at $T_J = 25^\circ\text{C}$ (unless otherwise noted)

PARAMETER		TEST CONDITIONS	MIN	TYP	MAX	UNIT
BOOST CONVERTER 2 (AV_{DD})						
AV_{DD}	Output voltage	SELP2 = Low		7.7		V
		SELP2 = High		5.8		
AV_{DD}	Output voltage accuracy	$25^\circ\text{C} \leq T_A \leq 85^\circ\text{C}$, no load	-1%		1%	
		$-30^\circ\text{C} \leq T_A \leq 85^\circ\text{C}$, no load	-1.3%		1.3%	
$r_{DS(on)3A}$	SWP2 switch on-resistance	$I_{(SWP2)} = 200\text{ mA}$		400		m Ω
$r_{DS(on)3B}$	SWP2 rectifier on-resistance			650		
f_{SW3}	Switching frequency	$I_{AVDD} = 0\text{ mA}$		1.7		MHz
I_{LIM3}	Switch current limit	Inductor valley current	0.25	0.35	0.45	A
R_{DCHG3}	Discharge resistance	$EN = GND$, $I_{(SWP2)} = 1\text{ mA}$	10	30	70	Ω
	Line regulation	$I_{AVDD} = 30\text{ mA}$		0.02		%/V
	Load regulation			0.18		%/A
CTRL INTERFACE (CTRL, EN, SELP2)						
V_{IH}	Logic input high level voltage		1.2			V
V_{IL}	Logic input low level voltage				0.4	V
R	Pull-down resistance		150	400	860	k Ω
OTHER						
R_{CT}	CT pin resistance		150	300	500	k Ω
t_{INIT}	Initialization time			300	400	μs
t_{STORE}	Data storage/accept time period		30		80	μs
t_{SDN}	Shutdown time period		30		80	μs
T_{SD}	Thermal shutdown temperature	Temperature rising		145		$^\circ\text{C}$

6.6 Timing Requirements

		MIN	NOM	MAX	UNIT
CTRL INTERFACE					
t_{LOW}	Low-level pulse duration	2	10	25	μs
t_{HIGH}	High-level pulse duration	2	10	25	μs
t_{OFF}	Shutdown pulse duration (CTRL = low)	200			μs

6.7 Typical Characteristics

$T_J = 25^\circ\text{C}$, $V_I = 3.7\text{ V}$, unless otherwise stated.

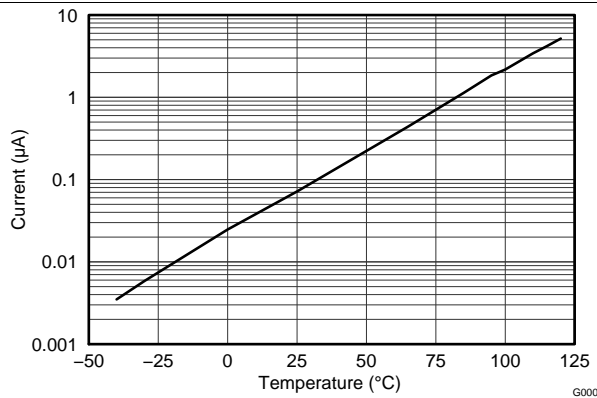

Figure 1. Shutdown Current into AVIN and PVIN Pins

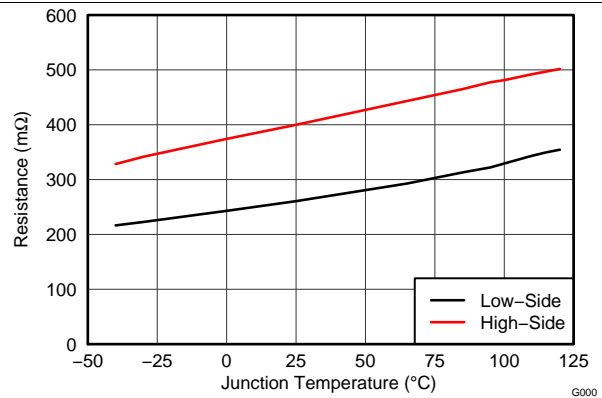

Figure 2. Boost Converter 1 (V_{POS}) $r_{DS(ON)}$

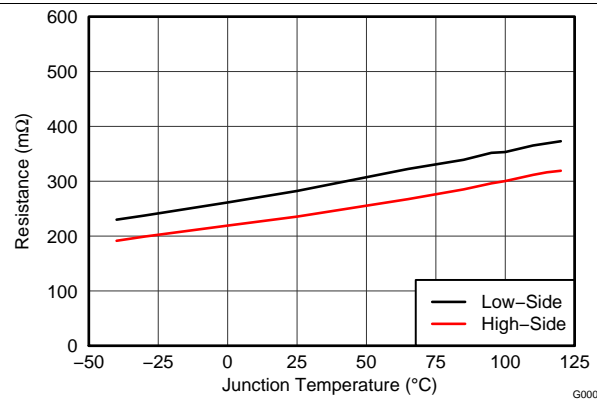

Figure 3. Inverting Buck-Boost Converter (V_{NEG}) $r_{DS(ON)}$

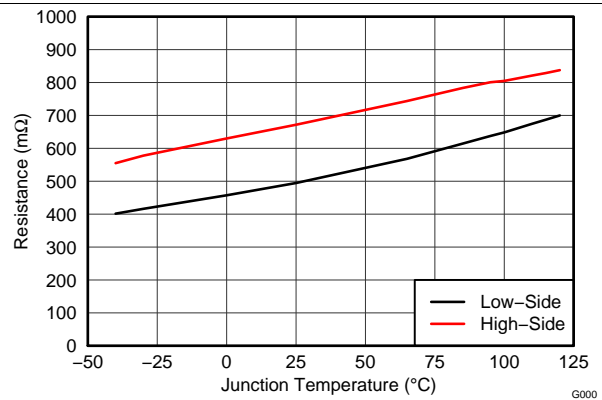

Figure 4. Boost Converter 2 (AV_{DD}) $r_{DS(ON)}$

7 Detailed Description

7.1 Overview

The TPS65632 consists of two boost converters and an inverting buck-boost converter. The V_{POS} output is fixed at 4.6 V and V_{NEG} is programmable via a digital interface in the range of -1.4 V to -5.4 V; the default is -4 V. AV_{DD} can be selected between 7.7 V and 5.8 V, using the SELP2 pin. The transition time of V_{NEG} output is adjustable by the CT pin capacitor.

7.2 Functional Block Diagram

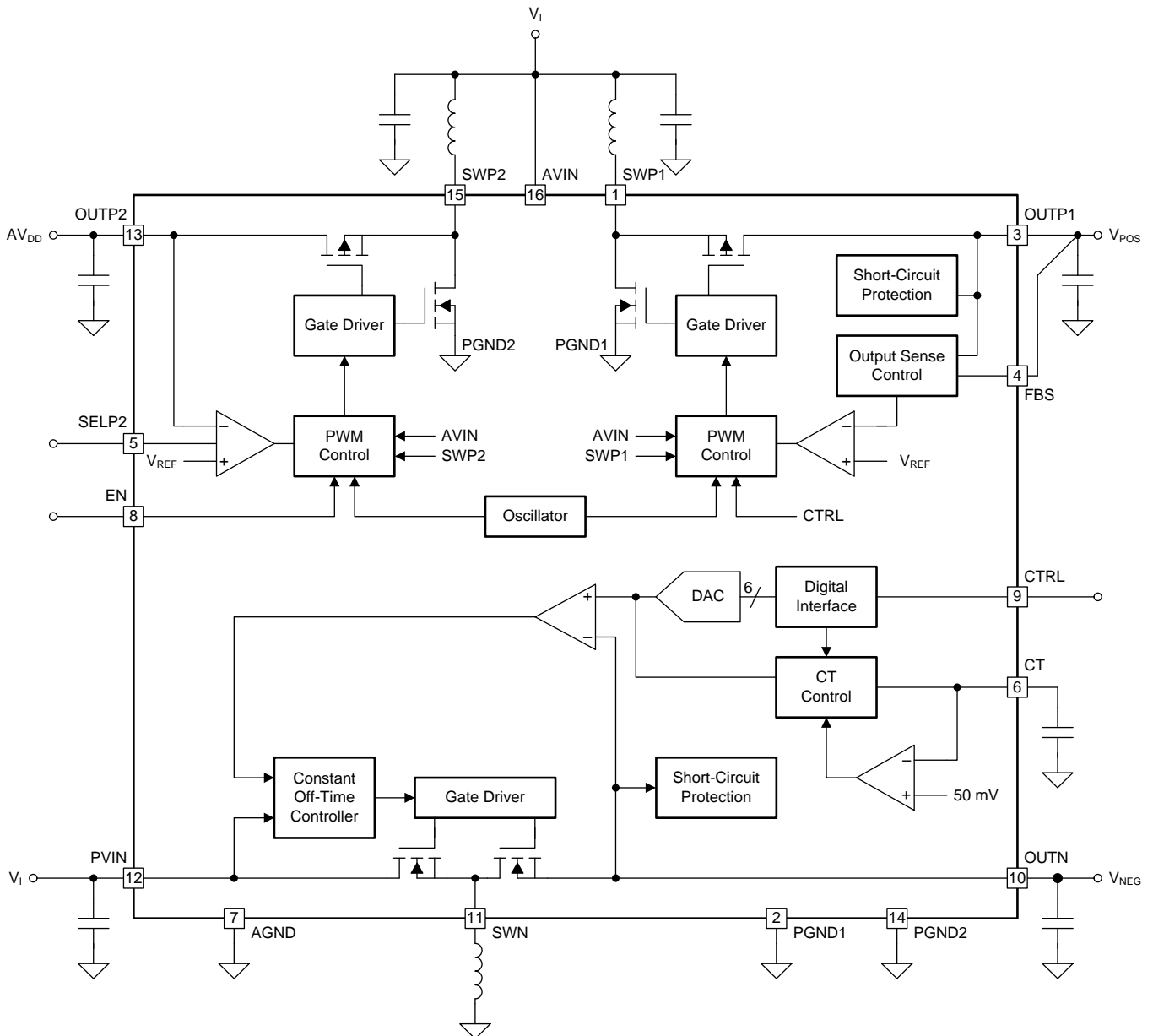

Feature Description (continued)
Table 1.

Bit / Rising Edges	V _{NEG}	DAC Value	Bit / Rising Edges	V _{NEG}	DAC Value
0 / no pulse	–4.0 V	000000	21	–3.4 V	010101
1	–5.4 V	000001	22	–3.3 V	010110
2	–5.3 V	000010	23	–3.2 V	010111
3	–5.2 V	000011	24	–3.1 V	011000
4	–5.1 V	000100	25	–3.0 V	011001
5	–5.0 V	000101	26	–2.9 V	011010
6	–4.9 V	000110	27	–2.8 V	011011
7	–4.8 V	000111	28	–2.7 V	011100
8	–4.7 V	001000	29	–2.6 V	011101
9	–4.6 V	001001	30	–2.5 V	011110
10	–4.5 V	001010	31	–2.4 V	011111
11	–4.4 V	001011	32	–2.3 V	100000
12	–4.3 V	001100	33	–2.2 V	100001
13	–4.2 V	001101	34	–2.1 V	100010
14	–4.1 V	001110	35	–2.0 V	100011
15	–4.0 V	001111	36	–1.9 V	100100
16	–3.9 V	010000	37	–1.8 V	100101
17	–3.8 V	010001	38	–1.7 V	100110
18	–3.7 V	010010	39	–1.6 V	100111
19	–3.6 V	010011	40	–1.5 V	101000
20	–3.5 V	010100	41	–1.4 V	101001

7.3.2.2 Controlling V_{NEG} Transition Time

The transition time (t_{SET}) is the time required to move V_{NEG} from one voltage level to the next. Users can control the transition time with a capacitor connected between the CT pin and ground. When the CT pin is left open or connected to ground the transition time is as short as possible. When a capacitor is connected to the CT pin the transition time is determined by the time constant (τ) of the external capacitor ($C_{(CT)}$) and the internal resistance of the CT pin (R_{CT}). The output voltage reaches 70% of its programmed value after 1τ .

An example is given when using 100 nF for $C_{(CT)}$.

$$\tau = 300 \text{ k}\Omega \times 100 \text{ nF} = 30 \text{ ms} \quad (1)$$

The output voltage is at 70% of its final value after 1τ (i.e. 30 ms in this case) and at its final value after approximately 3τ (90 ms in this case).

7.3.3 Boost Converter 2 (AV_{DD})

Boost converter 2 uses a fixed-frequency current-mode topology. The TPS65632 device supports fixed output voltages of 5.8 V and 7.7 V, selected by the SELP2 pin. $AV_{DD} = 7.7 \text{ V}$ when SELP2 is low or left floating, and $AV_{DD} = 5.8 \text{ V}$ when SELP2 is high.

7.3.4 Soft Start and Start-Up Sequence

The devices feature a soft-start function to limit inrush current. Boost converter 2 (AV_{DD}) is enabled when EN goes high. When CTRL goes high, boost converter 1 starts with a reduced switch current limit and 10 ms later the inverting buck-boost converter (V_{NEG}) starts with its default value of –4 V. The typical start-up sequence is shown in [Figure 6](#). The two boost converters operate independently and boost converter 1 (V_{POS}) does not require boost converter 2 (AV_{DD}) to be in regulation in order for it to start..

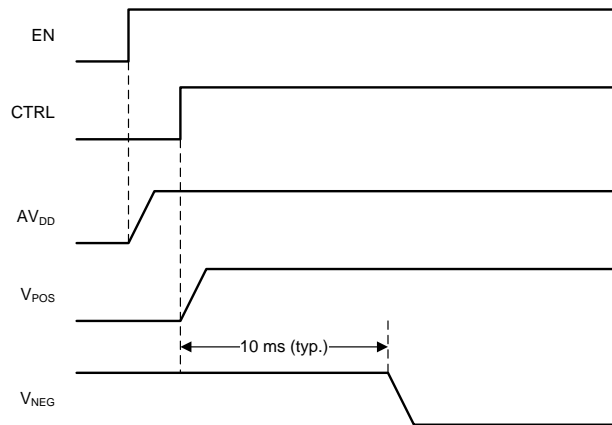

Figure 6. Start-Up Sequence

7.3.5 Enable (CTRL)

The CTRL pin serves two functions: one is to enable and disable the device, and the other is to program the output voltage (V_{NEG}) of the inverting buck-boost converter (see [Programming \$V_{NEG}\$](#)). If the V_{NEG} programming function is not required the CTRL pin can be used as a standard enable pin for the device, which will start up with its default value of -4.0 V on V_{NEG} . The device is enabled when CTRL is pulled high and disabled when CTRL is pulled low.

Note that to ensure proper start up CTRL must be pulled low for a minimum of $200\ \mu\text{s}$ before being pulled high again.

7.3.6 Undervoltage Lockout

The device features an undervoltage lockout function that disables it when the input supply voltage is too low for proper operation.

7.3.7 Short-Circuit Protection

7.3.7.1 Short Circuits During Operation

The device is protected against short circuits of V_{POS} and V_{NEG} to ground and short circuit of these two outputs to each other. During normal operation an error condition is detected if V_{POS} falls below 4.1 V for longer than 3 ms or V_{NEG} is pulled above the programmed nominal output by 500 mV for longer than 3 ms . In either case the device goes into shutdown and the outputs are disconnected from the input. This state is latched, and to resume normal operation, V_I has to cycle below the undervoltage lockout threshold, or CTRL has to toggle LOW and then HIGH.

7.3.7.2 Short Circuits During Start Up

During start up an error condition is detected in the following cases:

- V_{POS} is not in regulation 10 ms after CTRL goes HIGH
- V_{NEG} is higher than threshold level 10 ms after CTRL goes HIGH
- V_{NEG} is not in regulation 20 ms after CTRL goes HIGH

If any of the above conditions is met the device goes into shutdown and the outputs are disconnected from the input. This state is latched, and to resume normal operation V_I has to cycle below the undervoltage threshold, or CTRL has to toggle LOW and HIGH.

7.3.8 Output Discharge During Shut Down

The device discharges outputs during shutdown. [Figure 7](#) shows the discharge control.

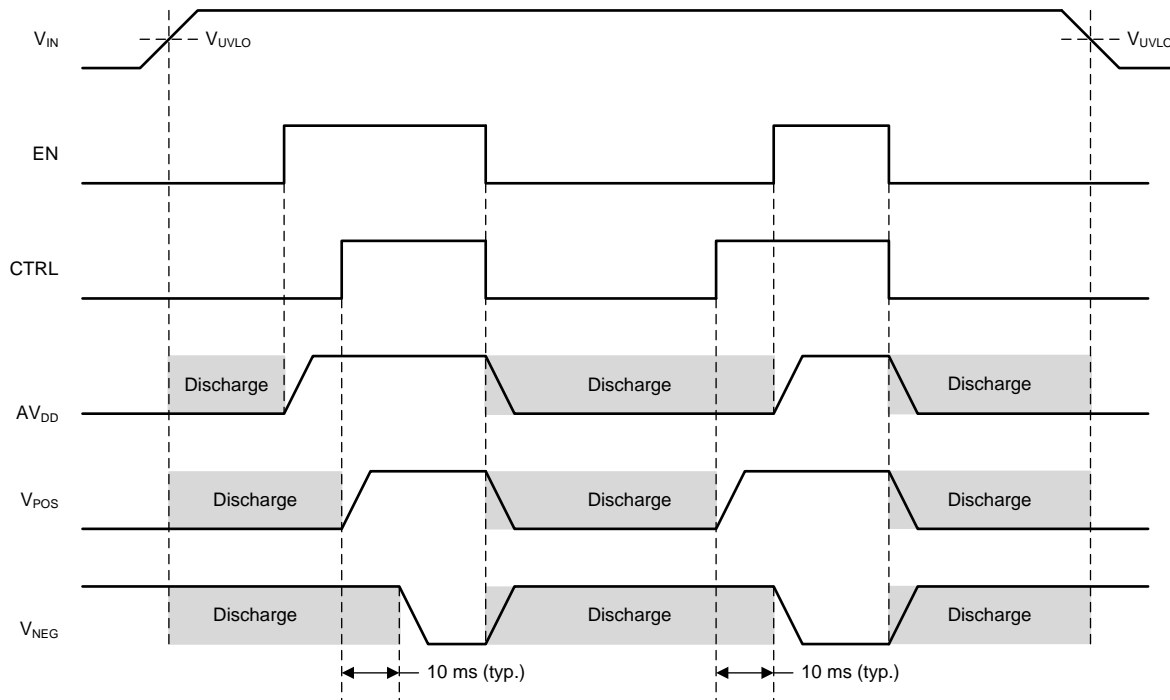

Figure 7. Outputs Discharge During Shut Down

7.3.9 Thermal Shutdown

The TPS65632 device enters thermal shutdown if its junction temperature exceeds 145°C (typical). During thermal shutdown none of the device's functions are available. To resume normal operation V_I has to cycle below the undervoltage threshold, or CTRL has to toggle LOW and then HIGH.

7.4 Device Functional Modes

7.4.1 Operation with $V_I < 2.9\text{ V}$

The recommended minimum input supply voltage for full-performance is 2.9 V. The device continues to operate with input supply voltages below 2.9 V, however, full performance is not guaranteed. The TPS65632 device does not operate with input supply voltages below the UVLO threshold.

7.4.2 Operation with $V_I \approx V_{POS}$ (Diode Mode)

The TPS65632 device features a "diode" mode that enables it to regulate its V_{POS} output even when the input supply voltage is close to V_{POS} (that is, too high for normal boost operation). When operating in diode mode the V_{POS} boost converter's high-side switch is disabled and its body diode used as the rectifier. Note that a minimum load of $\approx 2\text{ mA}$ is required to proper output regulation in diode mode.

7.4.3 Operation with CTRL

When a low-level signal is applied to the CTRL pin the device is disabled and switching is inhibited. When the input supply voltage is above the UVLO threshold and a high-level signal is applied to the CTRL pin the device is enabled and its start-up sequence begins.

8 Application and Implementation

NOTE

Information in the following applications sections is not part of the TI component specification, and TI does not warrant its accuracy or completeness. TI's customers are responsible for determining suitability of components for their purposes. Customers should validate and test their design implementation to confirm system functionality.

8.1 Application Information

The TPS65632 device is intended to supply the main analog supplies required by AMOLED displays in smartphone applications. V_{POS} is fixed at 4.6 V, but V_{NEG} can be programmed using the CTRL pin to voltages in the range -1.4 V to -5.4 V. The SELP2 pin can be used to set AV_{DD} to either 5.8 V or 7.7 V. The device is highly integrated and requires few external components.

8.2 Typical Application

Figure 8 shows a typical application circuit suitable for supplying AMOLED displays in smartphone applications. The circuit is designed to operate from a single-cell Li-Ion battery and generates a positive output voltage V_{POS} of 4.6 V, a negative output voltage V_{NEG} of -4.0 V, and a positive output voltage AV_{DD} of 5.8 V or 7.7 V. The V_{POS} and V_{NEG} outputs are each capable of supplying up to 300 mA of current, and the AV_{DD} output of up to 30 mA.

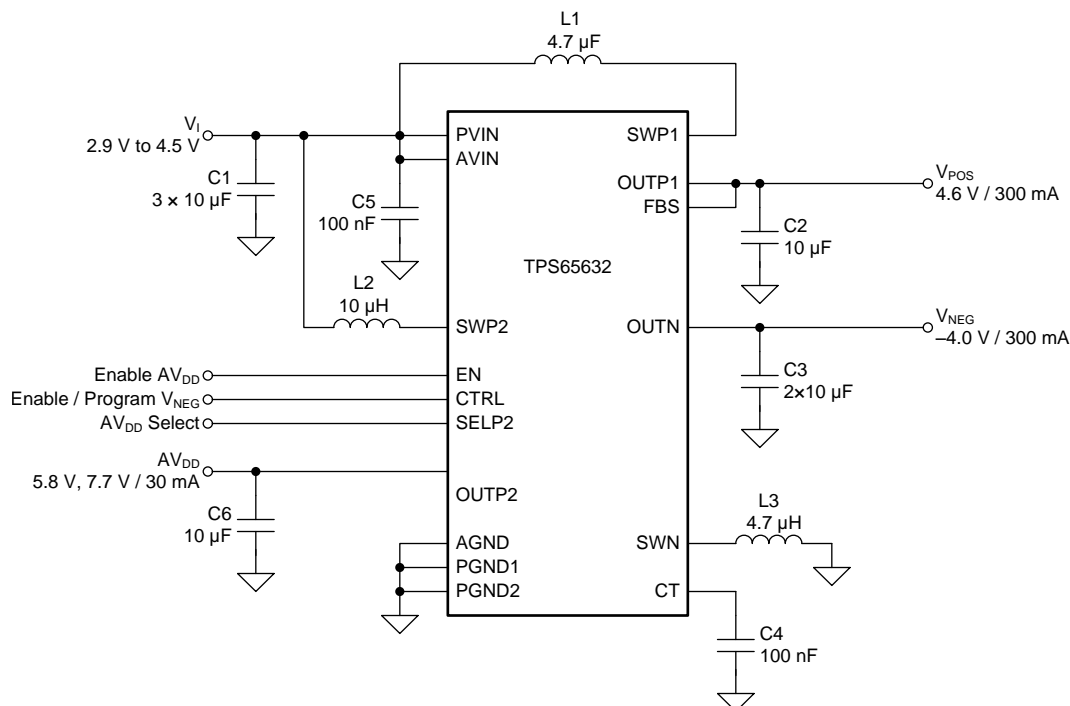

Figure 8. Typical Application Circuit

Typical Application (continued)

8.2.1 Design Requirements

For this design example, use the parameters shown in [Table 2](#)

Table 2. Design Parameters

PARAMETER	VALUE
Input voltage range	2.9 V to 4.5 V
Output voltage	$V_{POS} = 4.6\text{ V}$ $V_{NEG} = -4.0\text{ V}$ $AV_{DD} = 7.7\text{ V}$
Current	$I_{(VPOS)} = 300\text{ mA}$ $I_{(VNEG)} = 300\text{ mA}$ $I_{(AVDD)} = 30\text{ mA}$
Switching Frequency	$f_{(SWP1)} = 1.7\text{ MHz}$ $f_{(SWN)} = 1.7\text{ MHz}$ $f_{(SWP2)} = 1.7\text{ MHz}$

8.2.2 Detailed Design Procedure

In order to maximize performance, the TPS65632 device has been optimized for use with a relatively narrow range of component values, and customers are strongly recommended to use the application circuits shown in [Figure 8](#) with the components listed in [Table 3](#) and [Table 4](#).

8.2.2.1 Inductor Selection

The V_{POS} and V_{NEG} converters have been optimized for use with 4.7- μH inductors and the AV_{DD} boost converter has been optimized for use with 10- μH inductors. For optimum performance it is recommended that these values be used in all applications. Customers using different inductors than the ones in [Table 3](#) are strongly recommended to characterize circuit performance fully before finalizing their design. Customers should pay particular attention to the inductors' saturation current and ensure it is adequate for their application's worst-case conditions (which may also be during start-up).

Table 3. Inductor Selection

REFERENCE DESIGNATOR	VALUE	MANUFACTURER	PART NUMBER
L1, L3	4.7 μH	Coilcraft	XFL4020-4R7ML
L2	10 μH	Coilmaster	MMPP252012-100N

8.2.2.2 Capacitor Selection

The recommended capacitor values are shown in [Table 4](#). Applications using less than the recommended capacitance (e.g. to save PCB area) may exhibit increased voltage ripple. In general, the lower the output current, the lower the necessary capacitance. Customers should be aware that ceramic capacitors of the kind typically used with the TPS65632 device exhibit dc bias effects, which means their effective capacitance under normal operating conditions may be significantly lower than their nominal capacitance value. Customers must ensure that the *effective* capacitance is sufficient for their application's performance requirements.

Table 4. Capacitor Selection

REFERENCE DESIGNATOR	VALUE	MANUFACTURER	PART NUMBER
C1	3 \times 10 μF	Murata	GRM21BR71A106KE51
C2, C6	10 μF	Murata	GRM21BR71A106KE51
C3	2 \times 10 μF	Murata	GRM21BR71A106KE51
C4, C5	100 nF	Murata	GRM155B11A104KA01

8.2.3 Application Curves

Unless otherwise stated: $T_A = 25^\circ\text{C}$, $V_I = 3.7\text{ V}$, $V_{\text{POS}} = 4.6\text{ V}$, $V_{\text{NEG}} = -4.0\text{ V}$, $AV_{\text{DD}} = 7.7\text{ V}$; $L1 = L3 = \text{XFL4020-4R7ML}$, and $L2 = \text{MMPP252012-100N}$.

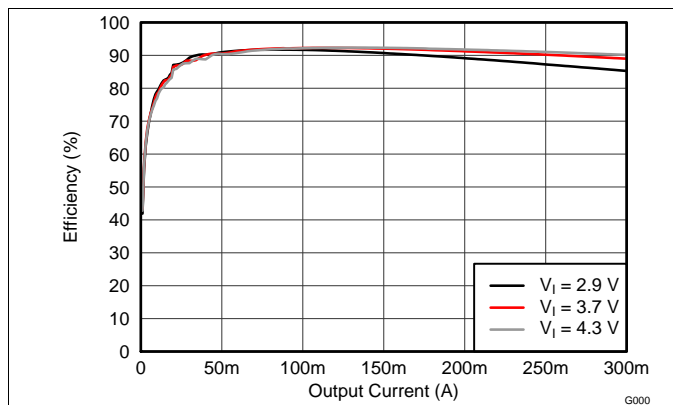

Figure 9. V_{POS} and V_{NEG} Combined Efficiency

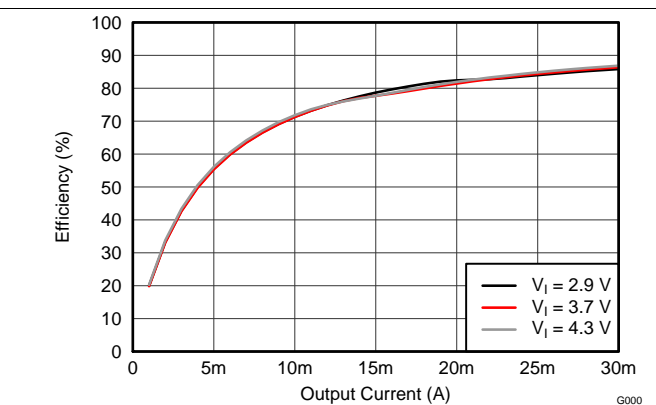

Figure 10. AV_{DD} Efficiency

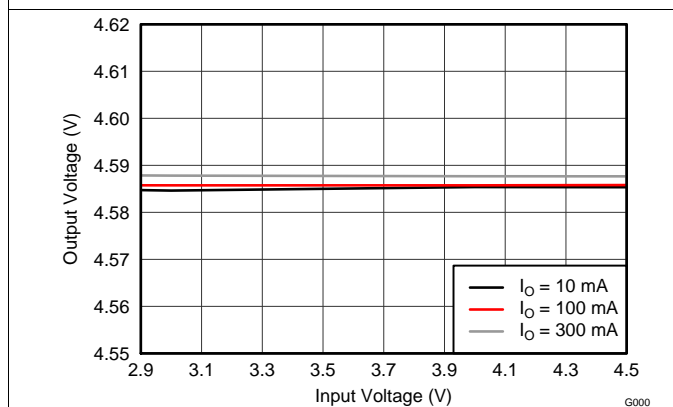

Figure 11. V_{POS} Line Regulation

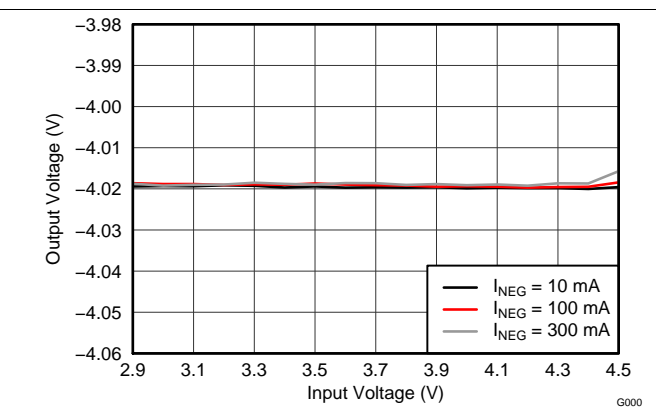

Figure 12. V_{NEG} Line Regulation

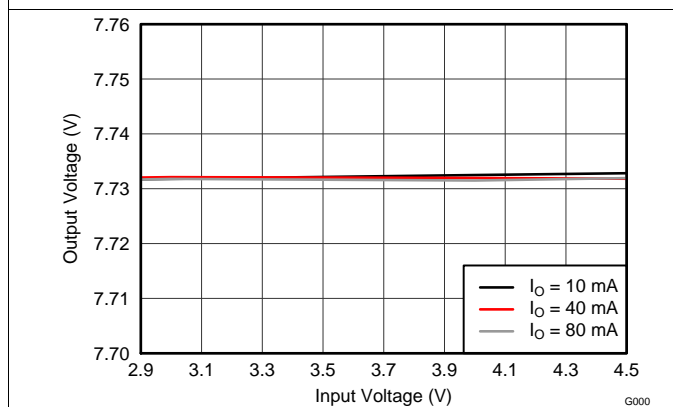

Figure 13. AV_{DD} Line Regulation

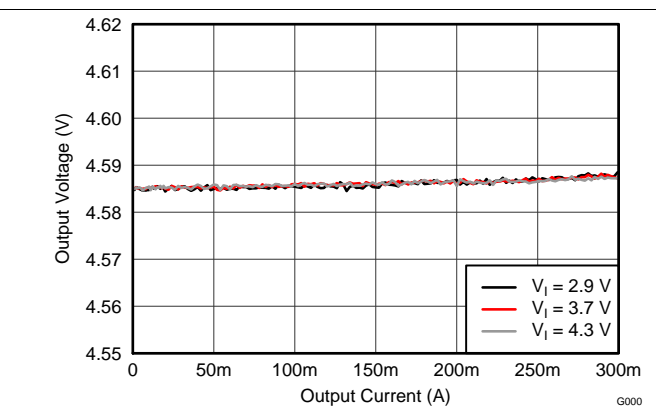

Figure 14. V_{POS} Load Regulation

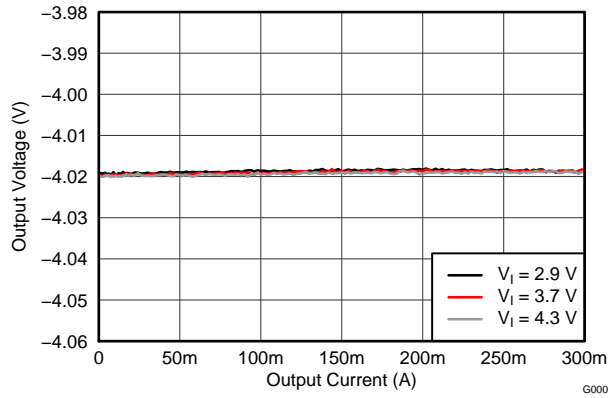

Figure 15. V_{NEG} Load Regulation

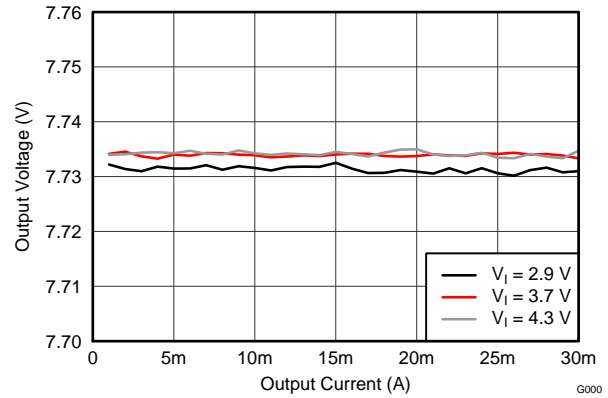

Figure 16. AV_{DD} Load Regulation

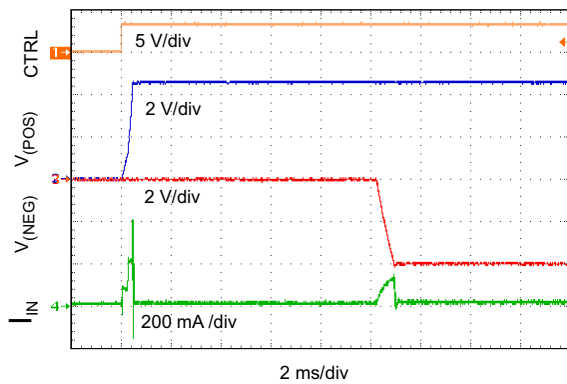

Figure 17. Start-Up: V_{POS} and V_{NEG}

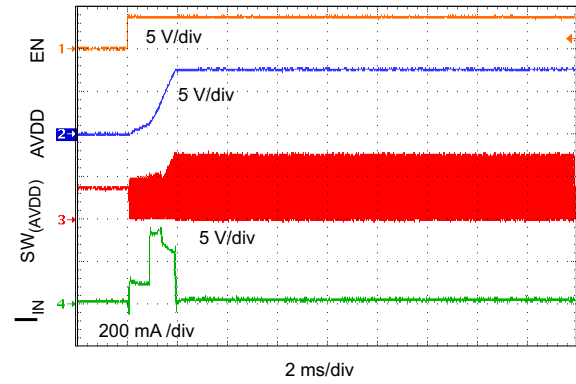

Figure 18. Start-Up: AV_{DD}

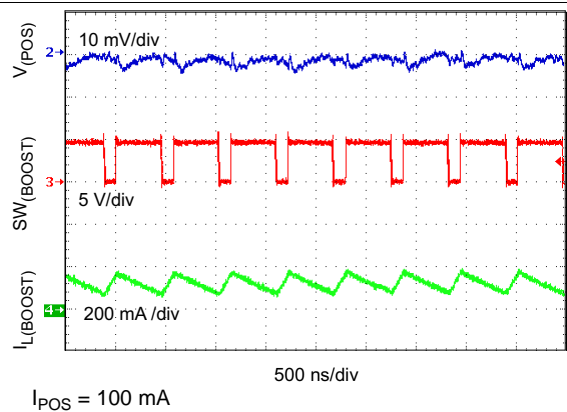

Figure 19. Switch Pin, Inductor Current and Output Voltage Waveforms: V_{POS}

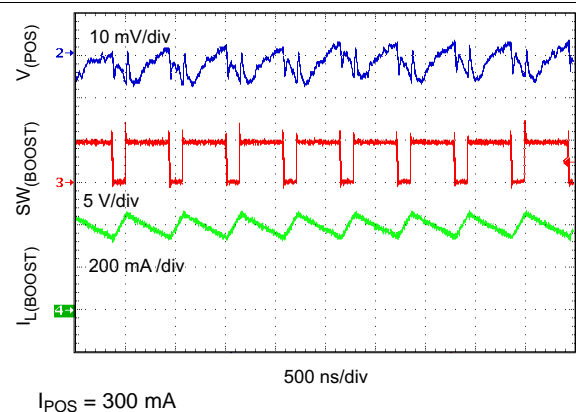

Figure 20. Switch Pin, Inductor Current and Output Voltage Waveforms: V_{POS}

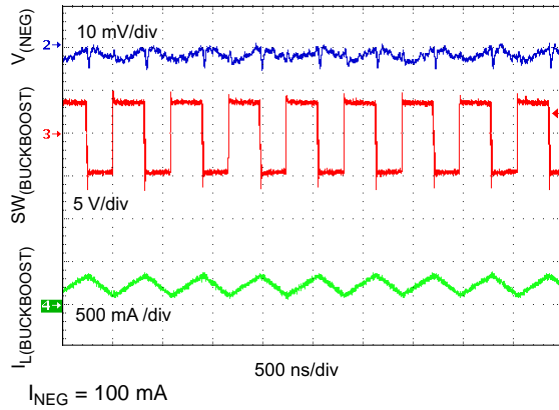

Figure 21. Switch Pin, Inductor Current and Output Voltage Waveforms: V_{NEG}

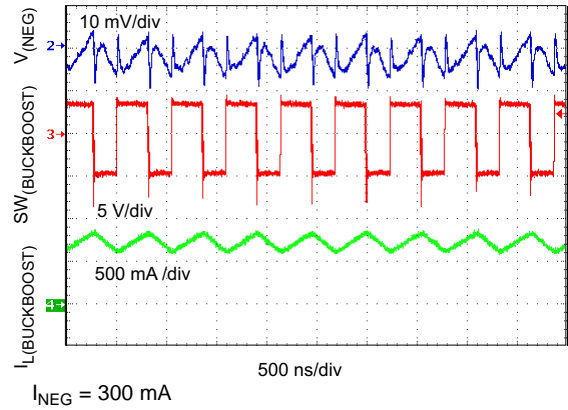

Figure 22. Switch Pin, Inductor Current and Output Voltage Waveforms: V_{NEG}

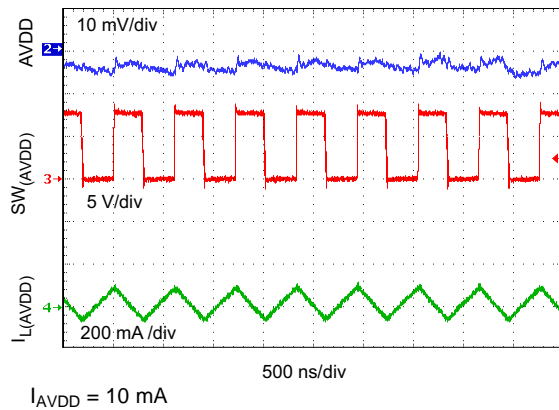

Figure 23. Switch Pin, Inductor Current and Output Voltage Waveforms: AV_{DD}

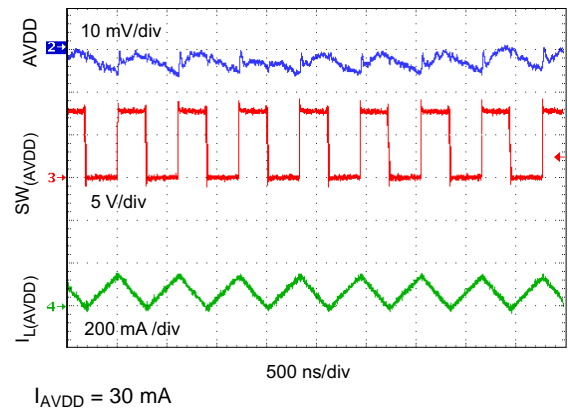

Figure 24. Switch Pin, Inductor Current and Output Voltage Waveforms: AV_{DD}

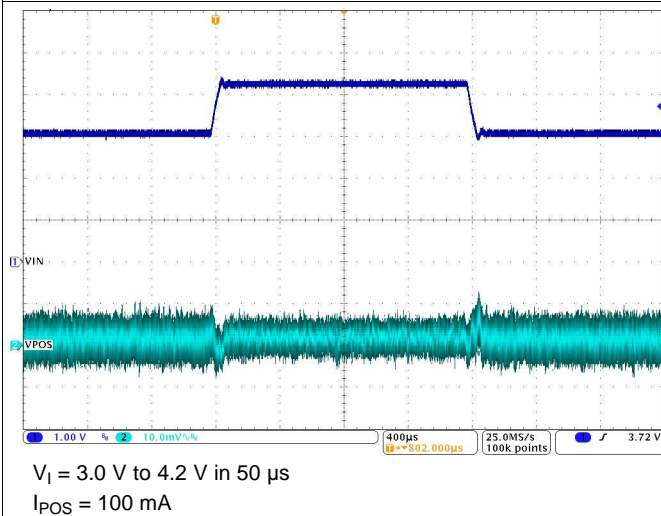

Figure 25. V_{POS} Line Transient Response

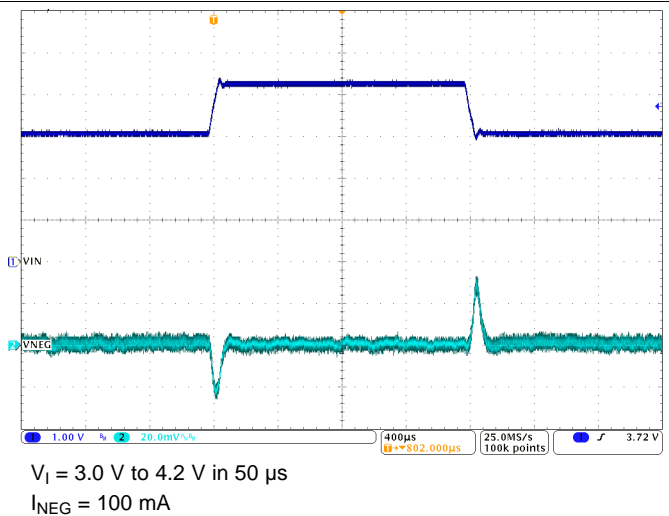
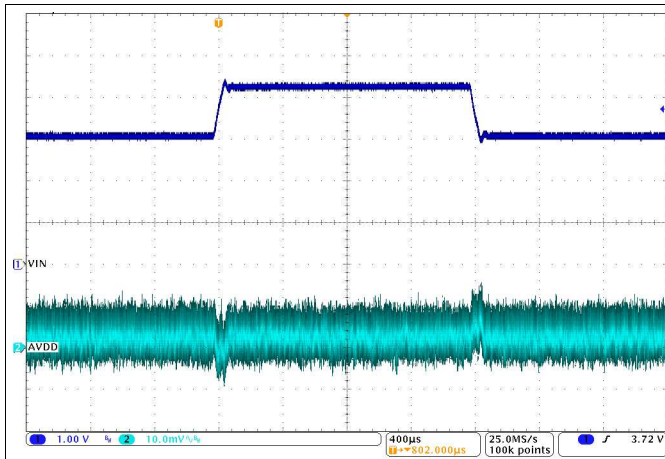
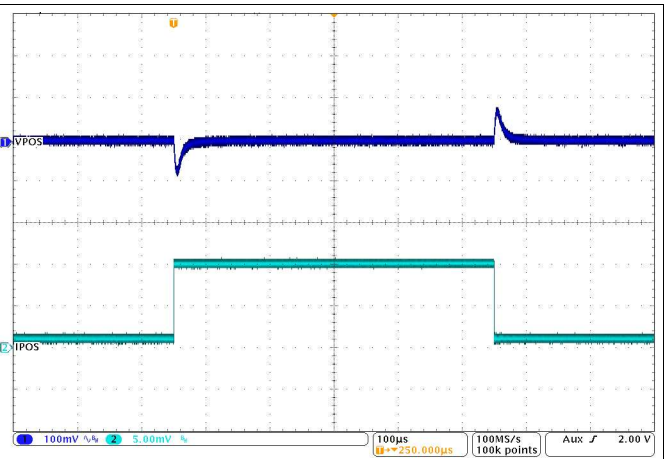

Figure 26. V_{NEG} Line Transient Response



$V_I = 3.0\text{ V to } 4.2\text{ V in } 50\ \mu\text{s}$
 $I_{AVDD} = 30\text{ mA}$

Figure 27. AV_{DD} Line Transient Response



$I_{POS} = 10\text{ mA to } 100\text{ mA in } 100\text{ ns}$

Figure 28. V_{POS} Load Transient Response

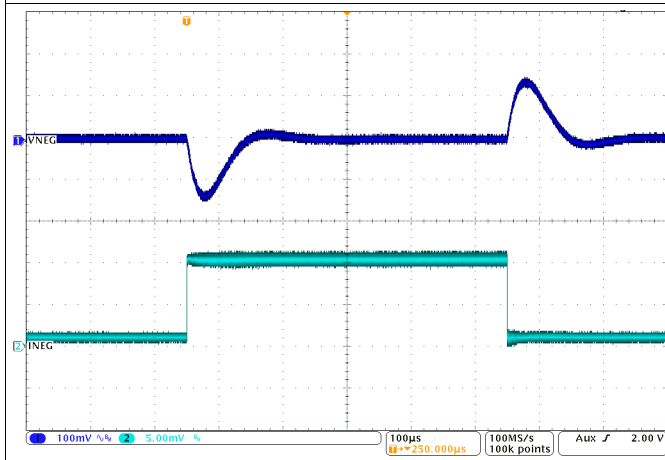

$I_{NEG} = 10\text{ mA to } 100\text{ mA in } 100\text{ ns}$

Figure 29. V_{NEG} Load Transient Response

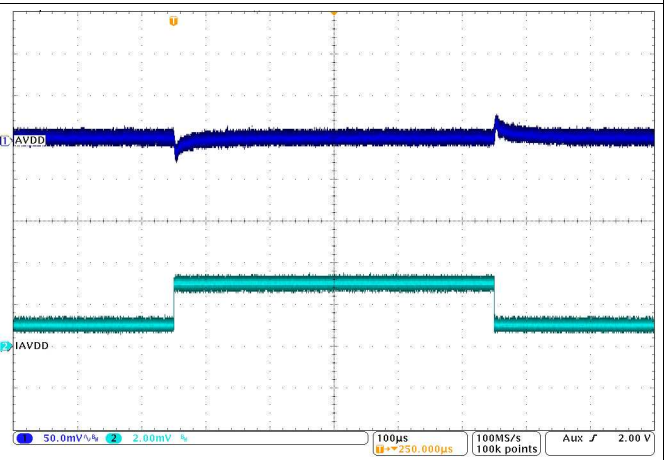

$I_{AVDD} = 10\text{ mA to } 30\text{ mA in } 100\text{ ns}$

Figure 30. AV_{DD} Load Transient Response

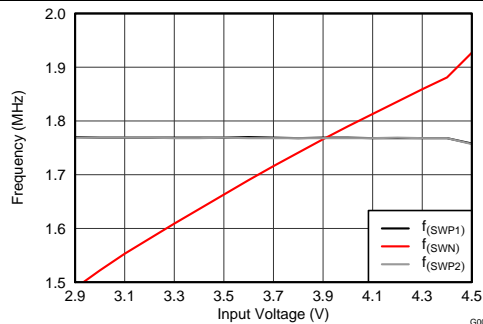

$I_{POS} = 100\text{ mA}$

$I_{NEG} = 100\text{ mA}$

$I_{AVDD} = 30\text{ mA}$

Figure 31. Switching Frequency

9 Power Supply Recommendations

The TPS65632 device is designed to operate with input supply voltages in the range 2.9 V to 4.5 V. If the input supply voltage is located more than a few centimeters away from the device, additional bulk capacitance may be required. The three 10- μ F capacitors shown in [Figure 8](#) are suitable for typical applications.

10 Layout

10.1 Layout Guidelines

- Place the input capacitor on PVIN and the output capacitor on OUTN as close as possible to device. Use short and wide traces to connect the input capacitor on PVIN and the output capacitor on OUTN.
- Place the output capacitor on OUTP1 and OUTP2 as close as possible to device. Use short and wide traces to connect the output capacitor on OUTP1 and OUTP2.
- Connect the ground of CT capacitor with AGND, pin 7, directly.
- Connect input ground and output ground on the same board layer, not through via hole.
- Connect AGND, PGND1 and PGND2 with exposed thermal pad.

10.2 Layout Example

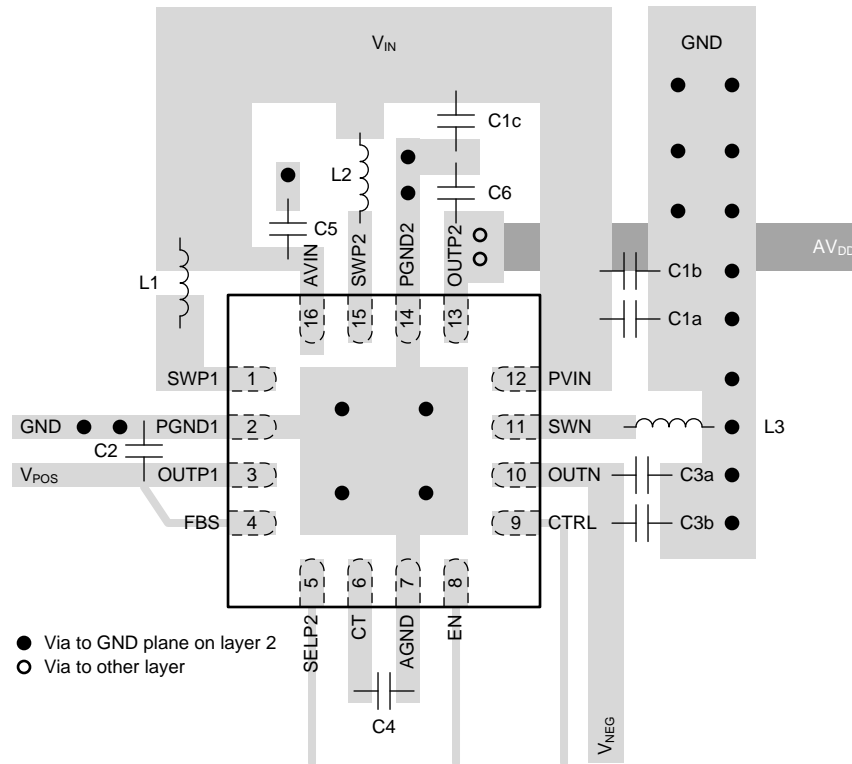

11 Device and Documentation Support

11.1 Device Support

11.1.1 Third-Party Products Disclaimer

TI'S PUBLICATION OF INFORMATION REGARDING THIRD-PARTY PRODUCTS OR SERVICES DOES NOT CONSTITUTE AN ENDORSEMENT REGARDING THE SUITABILITY OF SUCH PRODUCTS OR SERVICES OR A WARRANTY, REPRESENTATION OR ENDORSEMENT OF SUCH PRODUCTS OR SERVICES, EITHER ALONE OR IN COMBINATION WITH ANY TI PRODUCT OR SERVICE.

11.2 Trademarks

All trademarks are the property of their respective owners.

11.3 Electrostatic Discharge Caution



These devices have limited built-in ESD protection. The leads should be shorted together or the device placed in conductive foam during storage or handling to prevent electrostatic damage to the MOS gates.

11.4 Glossary

[SLYZ022](#) — *TI Glossary*.

This glossary lists and explains terms, acronyms, and definitions.

12 Mechanical, Packaging, and Ordering Information

The following pages include mechanical, packaging, and ordering information. This information is the most current data available for the designated devices. This data is subject to change without notice and revision of this document. For browser-based versions of this data sheet, refer to the left-hand navigation.

PACKAGING INFORMATION

Orderable Device	Status (1)	Package Type	Package Drawing	Pins	Package Qty	Eco Plan (2)	Lead finish/ Ball material (6)	MSL Peak Temp (3)	Op Temp (°C)	Device Marking (4/5)	Samples
TPS65632RTER	ACTIVE	WQFN	RTE	16	3000	RoHS & Green	NIPDAU	Level-1-260C-UNLIM	-40 to 85	PC6I	Samples
TPS65632RTET	ACTIVE	WQFN	RTE	16	250	RoHS & Green	NIPDAU	Level-1-260C-UNLIM	-40 to 85	PC6I	Samples

(1) The marketing status values are defined as follows:

ACTIVE: Product device recommended for new designs.

LIFEBUY: TI has announced that the device will be discontinued, and a lifetime-buy period is in effect.

NRND: Not recommended for new designs. Device is in production to support existing customers, but TI does not recommend using this part in a new design.

PREVIEW: Device has been announced but is not in production. Samples may or may not be available.

OBSOLETE: TI has discontinued the production of the device.

(2) **RoHS:** TI defines "RoHS" to mean semiconductor products that are compliant with the current EU RoHS requirements for all 10 RoHS substances, including the requirement that RoHS substance do not exceed 0.1% by weight in homogeneous materials. Where designed to be soldered at high temperatures, "RoHS" products are suitable for use in specified lead-free processes. TI may reference these types of products as "Pb-Free".

RoHS Exempt: TI defines "RoHS Exempt" to mean products that contain lead but are compliant with EU RoHS pursuant to a specific EU RoHS exemption.

Green: TI defines "Green" to mean the content of Chlorine (Cl) and Bromine (Br) based flame retardants meet JS709B low halogen requirements of <=1000ppm threshold. Antimony trioxide based flame retardants must also meet the <=1000ppm threshold requirement.

(3) MSL, Peak Temp. - The Moisture Sensitivity Level rating according to the JEDEC industry standard classifications, and peak solder temperature.

(4) There may be additional marking, which relates to the logo, the lot trace code information, or the environmental category on the device.

(5) Multiple Device Markings will be inside parentheses. Only one Device Marking contained in parentheses and separated by a "~" will appear on a device. If a line is indented then it is a continuation of the previous line and the two combined represent the entire Device Marking for that device.

(6) Lead finish/Ball material - Orderable Devices may have multiple material finish options. Finish options are separated by a vertical ruled line. Lead finish/Ball material values may wrap to two lines if the finish value exceeds the maximum column width.

Important Information and Disclaimer:The information provided on this page represents TI's knowledge and belief as of the date that it is provided. TI bases its knowledge and belief on information provided by third parties, and makes no representation or warranty as to the accuracy of such information. Efforts are underway to better integrate information from third parties. TI has taken and continues to take reasonable steps to provide representative and accurate information but may not have conducted destructive testing or chemical analysis on incoming materials and chemicals. TI and TI suppliers consider certain information to be proprietary, and thus CAS numbers and other limited information may not be available for release.

In no event shall TI's liability arising out of such information exceed the total purchase price of the TI part(s) at issue in this document sold by TI to Customer on an annual basis.

TAPE AND REEL INFORMATION

QUADRANT ASSIGNMENTS FOR PIN 1 ORIENTATION IN TAPE

*All dimensions are nominal

Device	Package Type	Package Drawing	Pins	SPQ	Reel Diameter (mm)	Reel Width W1 (mm)	A0 (mm)	B0 (mm)	K0 (mm)	P1 (mm)	W (mm)	Pin1 Quadrant
TPS65632RTER	WQFN	RTE	16	3000	330.0	12.4	3.3	3.3	1.1	8.0	12.0	Q2
TPS65632RTET	WQFN	RTE	16	250	180.0	12.4	3.3	3.3	1.1	8.0	12.0	Q2

TAPE AND REEL BOX DIMENSIONS

*All dimensions are nominal

Device	Package Type	Package Drawing	Pins	SPQ	Length (mm)	Width (mm)	Height (mm)
TPS65632RTER	WQFN	RTE	16	3000	335.0	335.0	25.0
TPS65632RTET	WQFN	RTE	16	250	182.0	182.0	20.0

GENERIC PACKAGE VIEW

RTE 16

WQFN - 0.8 mm max height

3 x 3, 0.5 mm pitch

PLASTIC QUAD FLATPACK - NO LEAD

This image is a representation of the package family, actual package may vary.
Refer to the product data sheet for package details.

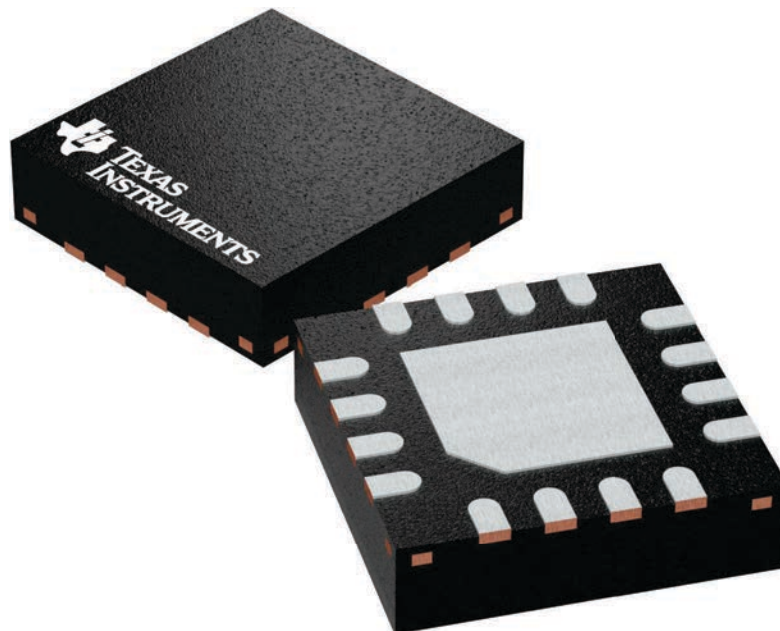

4225944/A

EXAMPLE BOARD LAYOUT

RTE0016C

WQFN - 0.8 mm max height

PLASTIC QUAD FLATPACK - NO LEAD

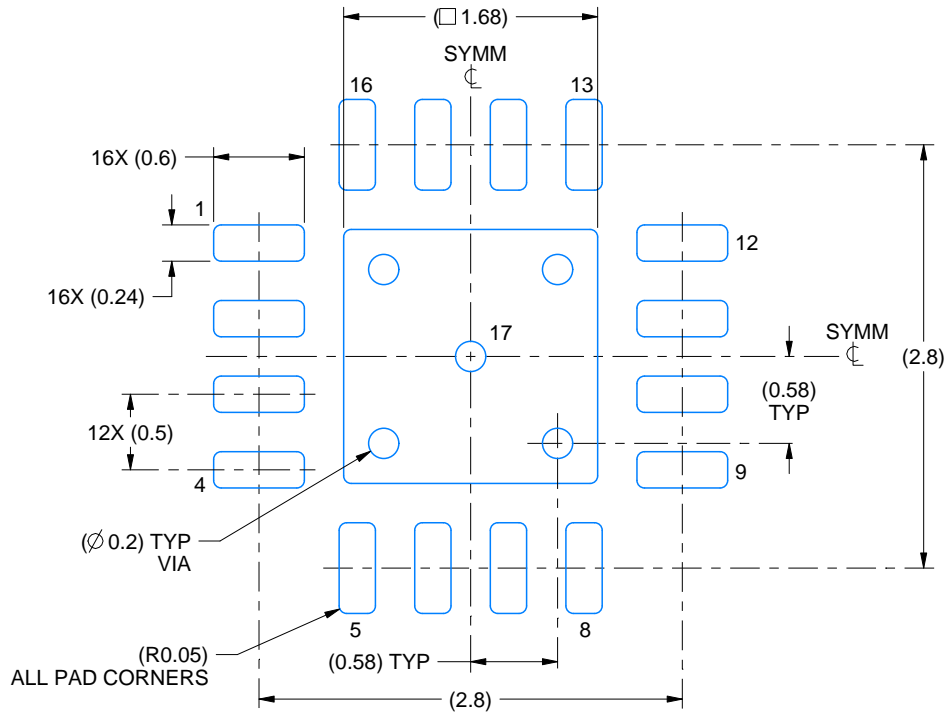

LAND PATTERN EXAMPLE
EXPOSED METAL SHOWN
SCALE:20X

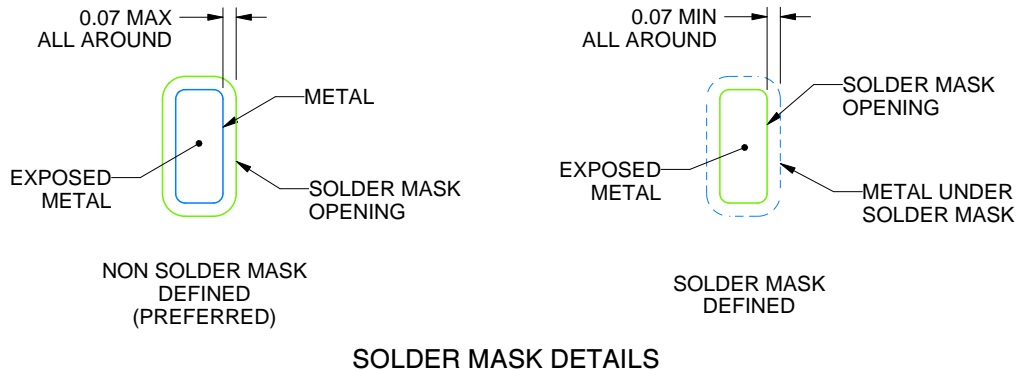

SOLDER MASK DETAILS

4219117/B 04/2022

NOTES: (continued)

- This package is designed to be soldered to a thermal pad on the board. For more information, see Texas Instruments literature number SLUA271 (www.ti.com/lit/slua271).
- Vias are optional depending on application, refer to device data sheet. If any vias are implemented, refer to their locations shown on this view. It is recommended that vias under paste be filled, plugged or tented.

EXAMPLE STENCIL DESIGN

RTE0016C

WQFN - 0.8 mm max height

PLASTIC QUAD FLATPACK - NO LEAD

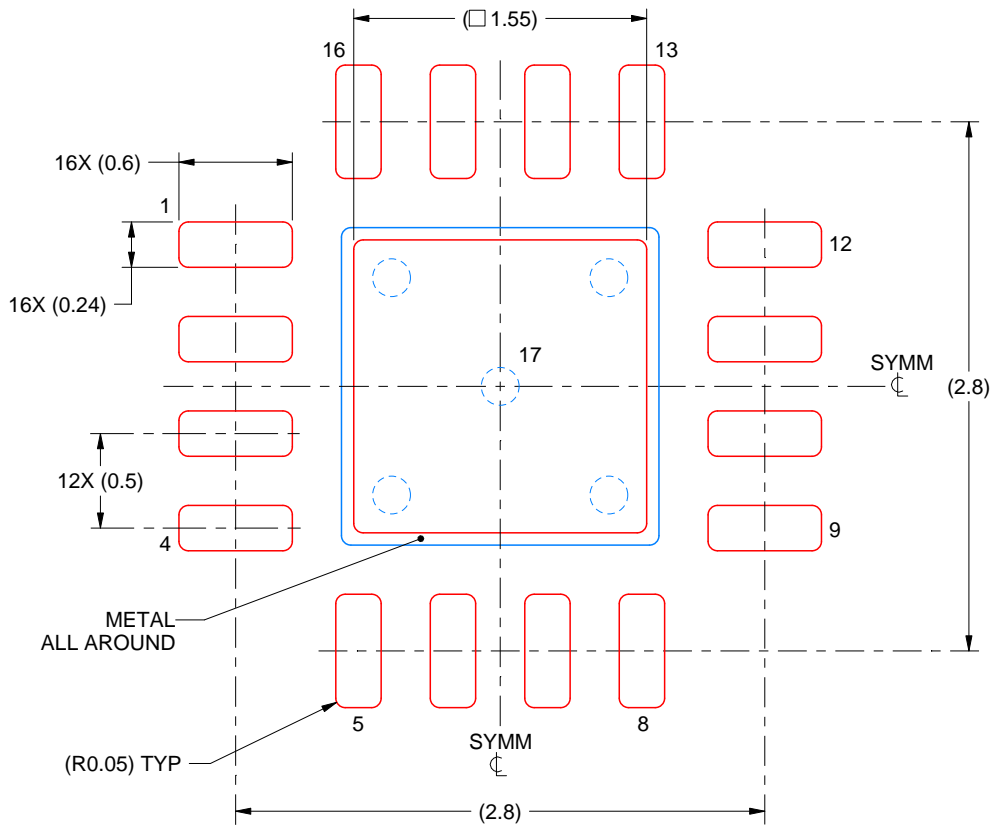

SOLDER PASTE EXAMPLE
BASED ON 0.125 mm THICK STENCIL

EXPOSED PAD 17:
85% PRINTED SOLDER COVERAGE BY AREA UNDER PACKAGE
SCALE:25X

4219117/B 04/2022

NOTES: (continued)

6. Laser cutting apertures with trapezoidal walls and rounded corners may offer better paste release. IPC-7525 may have alternate design recommendations.

IMPORTANT NOTICE AND DISCLAIMER

TI PROVIDES TECHNICAL AND RELIABILITY DATA (INCLUDING DATA SHEETS), DESIGN RESOURCES (INCLUDING REFERENCE DESIGNS), APPLICATION OR OTHER DESIGN ADVICE, WEB TOOLS, SAFETY INFORMATION, AND OTHER RESOURCES "AS IS" AND WITH ALL FAULTS, AND DISCLAIMS ALL WARRANTIES, EXPRESS AND IMPLIED, INCLUDING WITHOUT LIMITATION ANY IMPLIED WARRANTIES OF MERCHANTABILITY, FITNESS FOR A PARTICULAR PURPOSE OR NON-INFRINGEMENT OF THIRD PARTY INTELLECTUAL PROPERTY RIGHTS.

These resources are intended for skilled developers designing with TI products. You are solely responsible for (1) selecting the appropriate TI products for your application, (2) designing, validating and testing your application, and (3) ensuring your application meets applicable standards, and any other safety, security, regulatory or other requirements.

These resources are subject to change without notice. TI grants you permission to use these resources only for development of an application that uses the TI products described in the resource. Other reproduction and display of these resources is prohibited. No license is granted to any other TI intellectual property right or to any third party intellectual property right. TI disclaims responsibility for, and you will fully indemnify TI and its representatives against, any claims, damages, costs, losses, and liabilities arising out of your use of these resources.

TI's products are provided subject to [TI's Terms of Sale](#) or other applicable terms available either on [ti.com](https://www.ti.com) or provided in conjunction with such TI products. TI's provision of these resources does not expand or otherwise alter TI's applicable warranties or warranty disclaimers for TI products.

TI objects to and rejects any additional or different terms you may have proposed.

Mailing Address: Texas Instruments, Post Office Box 655303, Dallas, Texas 75265
Copyright © 2023, Texas Instruments Incorporated

Looking for pricing, stock, or lifecycle information?

Click below to explore more details on WIN SOURCE:

 [View TPS65632RTET](#) on WIN SOURCE

 [Texas Instruments](#) Information

Optimize Your Supply Chain with WIN SOURCE Solutions

-  Global Sourcing Solution
-  Obsolete Management
-  Cost Control Management
-  Shortage Management
-  Alternative Solution
-  Excess Inventory Management