



**THE DATASHEET OF
AZ1117BH-1.8TRE1**





LOW DROPOUT LINEAR REGULATOR

AZ1117B

General Description

The AZ1117B is a low dropout three-terminal regulator.

The AZ1117B has been optimized for low voltage where transient response and minimum input voltage are critical. It provides current limit and thermal shutdown. Its circuit includes a trimmed bandgap reference to assure output voltage accuracy to be within $\pm 1\%$. On-chip thermal shutdown provides protection against a combination of high current and ambient temperature that would create excessive junction temperature.

The AZ1117B is available in 1.2V, 1.5V, 1.8V, 2.5V, 3.3V, 5.0V fixed output voltage versions and ADJ output voltage version. The fixed versions integrate the adjust resistors. It is also available in an adjustable version which can set the output voltage with two external resistors.

The AZ1117B is available in the industry-standard SOT-223 and SOT-89 power packages.

Features

- Current Limit: 1.0A (Typ.)
- Output Noise from 10Hz to 10KHz: 0.003% of V_{OUT}
- PSRR at $I_{OUT}=300mA$ and $f=120Hz$: 70dB
- Output Voltage Accuracy: $\pm 1\%$
- On-chip Thermal Shutdown
- Maximum Quiescent Current: $I_{QMAX}=6mA$
- Operation Junction Temperature: -20 to $125^{\circ}C$

Applications

- USB Device
- Add-on Card
- DVD Player
- PC Motherboard

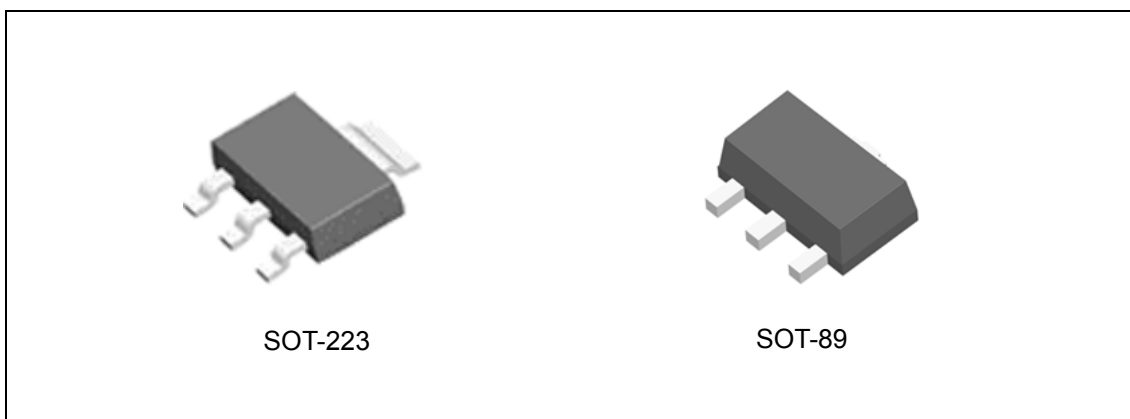

Figure 1. Package Type of AZ1117B



LOW DROPOUT LINEAR REGULATOR

AZ1117B

Pin Configuration



Figure 2. Pin Configuration of AZ1117B (Top View)

Functional Block Diagram

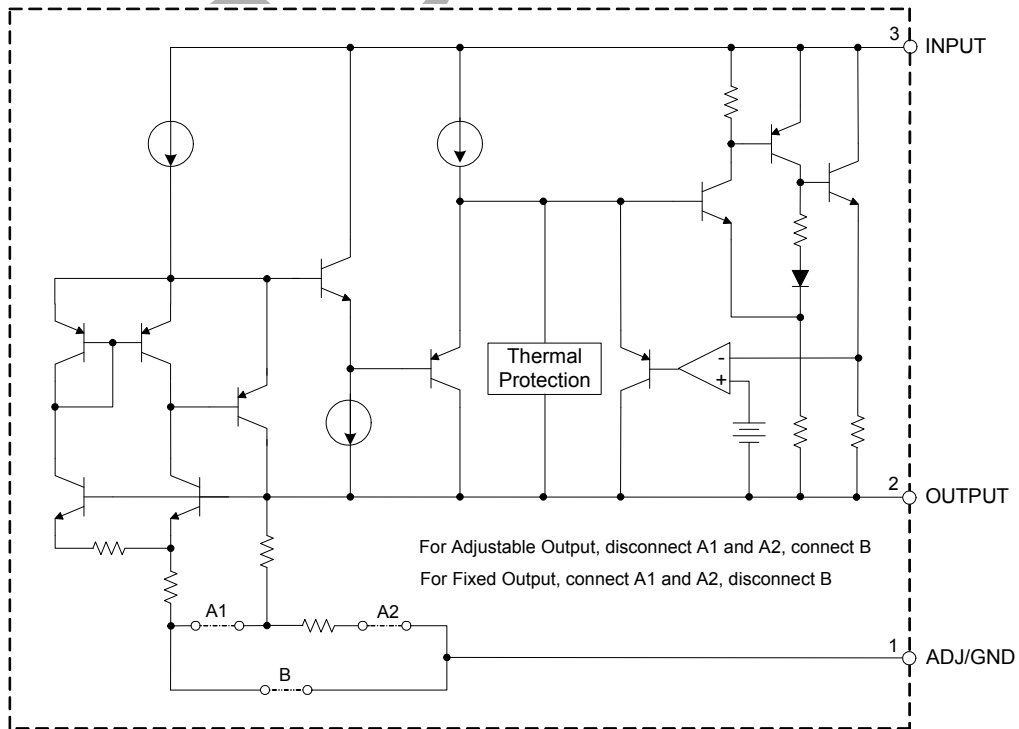

Figure 3. Functional Block Diagram of AZ1117B



LOW DROPOUT LINEAR REGULATOR

AZ1117B

Ordering Information

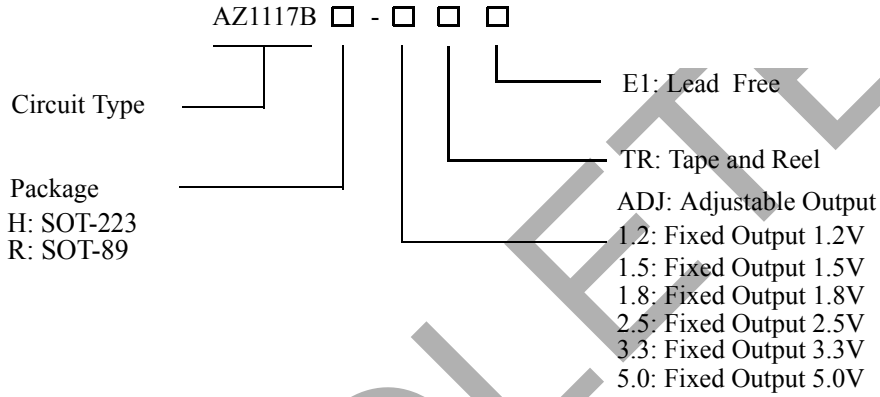

Package	Temperature Range	Part Number	Marking ID	Packing Type
SOT-223	-20 to 125°C	AZ1117BH-ADJTRE1	EH17K	Tape & Reel
		AZ1117BH-1.2TRE1	EH17P	Tape & Reel
		AZ1117BH-1.5TRE1	EH17Q	Tape & Reel
		AZ1117BH-1.8TRE1	EH17L	Tape & Reel
		AZ1117BH-2.5TRE1	EH17N	Tape & Reel
		AZ1117BH-3.3TRE1	EH17M	Tape & Reel
		AZ1117BH-5.0TRE1	EH17R	Tape & Reel
SOT-89	-20 to 125°C	AZ1117BR-ADJTRE1	E31F	Tape & Reel
		AZ1117BR-1.2TRE1	E31G	Tape & Reel
		AZ1117BR-1.5TRE1	E31H	Tape & Reel
		AZ1117BR-1.8TRE1	E31J	Tape & Reel
		AZ1117BR-2.5TRE1	E31K	Tape & Reel
		AZ1117BR-3.3TRE1	E31L	Tape & Reel
		AZ1117BR-5.0TRE1	E31M	Tape & Reel

BCD Semiconductor's Pb-free products, as designated with "E1" suffix in the part number, are RoHS compliant.

**LOW DROPOUT LINEAR REGULATOR****AZ1117B****Absolute Maximum Ratings (Note 1)**

Parameter	Symbol	Value	Unit
Input Voltage	V_{IN}	18	V
Operating Junction Temperature Range	T_J	150	°C
Storage Temperature Range	T_{STG}	-65 to 150	°C
Thermal Resistance (No Heatsink)	θ_{JA}	SOT-223	150
		SOT-89	210
Lead Temperature (Soldering, 10sec)	T_{LEAD}	260	°C

Note 1: Stresses greater than those listed under "Absolute Maximum Ratings" may cause permanent damage to the device. These are stress ratings only, and functional operation of the device at these or any other conditions beyond those indicated under "Recommended Operating Conditions" is not implied. Exposure to "Absolute Maximum Ratings" for extended periods may affect device reliability.

Recommended Operating Conditions

Parameter	Symbol	Min	Max	Unit
Input Voltage	V_{IN}		15	V
Operating Junction Temperature Range	T_J	-20	125	°C

LOW DROPOUT LINEAR REGULATOR
AZ1117B
Electrical Characteristics
AZ1117B-ADJ Electrical Characteristics

 Operating Conditions: $V_{IN}=V_{OUT}+2V$, $I_{OUT}=10mA$, $T_J=25^{\circ}C$, unless otherwise specified. ($P \leq$ maximum power dissipation).

 Limits appearing in **Boldface** type apply over the entire junction temperature range for operation, $-20^{\circ}C$ to $125^{\circ}C$.

Parameter	Symbol	Conditions	Min	Typ	Max	Unit	
Reference Voltage	V_{REF}		1.238	1.250	1.262	V	
		$1.5V \leq V_{IN} - V_{OUT} \leq 10V$	1.225	1.250	1.270		
Line Regulation	V_{RLINE}	$1.5V \leq V_{IN} - V_{OUT} \leq 10V$		0.001	0.1	%	
					0.2		
Load Regulation	V_{RLOAD}			0.4	1.0	%	
Dropout Voltage	V_{DROP}	$\Delta V_{REF}=1\%$, $I_{OUT}=0.8A$	SOT-223		1.2	1.3	V
			SOT-89		1.2		
Current Limit	I_{LIMIT}		0.85	1	1.15	A	
Adjust Pin Current				60	120	μA	
Adjust Pin Current Change		$1.5V \leq (V_{IN} - V_{OUT}) \leq 10V$		0.2	5	μA	
Minimum Load Current		$1.5V \leq (V_{IN} - V_{OUT}) \leq 10V$		1.7	5	mA	
Ripple Rejection	PSRR	$f=120Hz$, $C_{OUT}=22\mu F$ $(V_{IN} - V_{OUT})=3V$, $I_{OUT}=300mA$		70		dB	
Temperature Stability				0.5		%	
RMS Output Noise (% of V_{OUT})		$T_A=25^{\circ}C$, $10Hz \leq f \leq 10KHz$		0.003		%	
Thermal Shutdown		Junction Temperature		160		$^{\circ}C$	
Thermal Shutdown Hysteresis				16		$^{\circ}C$	
Thermal Resistance	θ_{JC}	SOT-223		33		$^{\circ}C/W$	
		SOT-89		39			

**LOW DROPOUT LINEAR REGULATOR****AZ1117B****Electrical Characteristics (Continued)****AZ1117B-1.2 Electrical Characteristics**

Operating Conditions: $V_{IN} \leq 10V$, $I_{OUT} = 10mA$, $T_J = 25^\circ C$, unless otherwise specified. ($P \leq$ maximum power dissipation). Limits appearing in **Boldface** type apply over the entire junction temperature range for operation, $-20^\circ C$ to $125^\circ C$.

Parameter	Symbol	Conditions	Min	Typ	Max	Unit	
Output Voltage	V_{OUT}		1.176	1.2	1.224	V	
		$3.2V \leq V_{IN} \leq 10V$	1.152	1.2	1.228		
Line Regulation	V_{RLINE}	$1.5V \leq V_{IN} - V_{OUT} \leq 10V$		0.5	6	mV	
					10		
Load Regulation	V_{RLOAD}			2	15	mV	
Dropout Voltage	V_{DROP}	$\Delta V_{OUT} = 1\%$, $I_{OUT} = 0.8A$	SOT-223		1.2	1.3	V
			SOT-89		1.2		
Current Limit	I_{LIMIT}		0.85	1	1.15	A	
Quiescent Current	I_Q	$I_{OUT} = 0$		4	6	mA	
Ripple Rejection	PSRR	$f = 120Hz$, $C_{OUT} = 22\mu F$ $(V_{IN} - V_{OUT}) = 3V$, $I_{OUT} = 300mA$		70		dB	
Temperature Stability				0.5		%	
RMS Output Noise (% of V_{OUT})		$T_A = 25^\circ C$, $10Hz \leq f \leq 10KHz$		0.003		%	
Thermal Shutdown		Junction Temperature		160		$^\circ C$	
Thermal Shutdown Hysteresis				16		$^\circ C$	
Thermal Resistance	θ_{JC}	SOT-223		33		$^\circ C/W$	
		SOT-89		39			

**LOW DROPOUT LINEAR REGULATOR****AZ1117B****Electrical Characteristics (Continued)****AZ1117B-1.5 Electrical Characteristics**

Operating Conditions: $V_{IN} \leq 10V$, $I_{OUT} = 10mA$, $T_J = 25^\circ C$, unless otherwise specified. ($P \leq$ maximum power dissipation). Limits appearing in **Boldface** type apply over the entire junction temperature range for operation, $-20^\circ C$ to $125^\circ C$.

Parameter	Symbol	Conditions	Min	Typ	Max	Unit	
Output Voltage	V_{OUT}		1.485	1.5	1.515	V	
		$3.5V \leq V_{IN} \leq 10V$	1.470	1.5	1.530		
Line Regulation	V_{RLINE}	$1.5V \leq V_{IN} - V_{OUT} \leq 10V$		0.5	6	mV	
					10		
Load Regulation	V_{RLOAD}			2	15	mV	
Dropout Voltage	V_{DROP}	$\Delta V_{OUT} = 1\%$, $I_{OUT} = 0.8A$	SOT-223		1.2	1.3	V
			SOT-89		1.2		
Current Limit	I_{LIMIT}		0.85	1	1.15	A	
Quiescent Current	I_Q	$I_{OUT} = 0$		4	6	mA	
Ripple Rejection	PSRR	$f = 120Hz$, $C_{OUT} = 22\mu F$ $(V_{IN} - V_{OUT}) = 3V$, $I_{OUT} = 300mA$		70		dB	
Temperature Stability				0.5		%	
RMS Output Noise (% of V_{OUT})		$T_A = 25^\circ C$, $10Hz \leq f \leq 10KHz$		0.003		%	
Thermal Shutdown		Junction Temperature		160		$^\circ C$	
Thermal Shutdown Hysteresis				16		$^\circ C$	
Thermal Resistance	θ_{JC}	SOT-223		33		$^\circ C/W$	
		SOT-89		39			

**LOW DROPOUT LINEAR REGULATOR****AZ1117B****Electrical Characteristics (Continued)****AZ1117B-1.8 Electrical Characteristics**

Operating Conditions: $V_{IN} \leq 10V$, $I_{OUT} = 10mA$, $T_J = 25^\circ C$, unless otherwise specified. ($P \leq$ maximum power dissipation). Limits appearing in **Boldface** type apply over the entire junction temperature range for operation, $-20^\circ C$ to $125^\circ C$.

Parameter	Symbol	Conditions	Min	Typ	Max	Unit
Output Voltage	V_{OUT}		1.782	1.8	1.818	V
		$3.8V \leq V_{IN} \leq 10V$	1.764	1.8	1.836	
Line Regulation	V_{RLINE}	$1.5V \leq V_{IN} - V_{OUT} \leq 10V$		0.5	6	mV
					10	
Load Regulation	V_{RLOAD}			2	15	mV
Dropout Voltage	V_{DROP}	$\Delta V_{OUT} = 1\%$, $I_{OUT} = 0.8A$	SOT-223	1.2	1.3	V
			SOT-89	1.2		
Current Limit	I_{LIMIT}		0.85	1	1.15	A
Quiescent Current	I_Q	$I_{OUT} = 0$		4	6	mA
Ripple Rejection	PSRR	$f = 120Hz$, $C_{OUT} = 22\mu F$ $(V_{IN} - V_{OUT}) = 3V$, $I_{OUT} = 300mA$		70		dB
Temperature Stability				0.5		%
RMS Output Noise (% of V_{OUT})		$T_A = 25^\circ C$, $10Hz \leq f \leq 10KHz$		0.003		%
Thermal Shutdown		Junction Temperature		160		$^\circ C$
Thermal Shutdown Hysteresis				16		$^\circ C$
Thermal Resistance	θ_{JC}	SOT-223		33		$^\circ C/W$
		SOT-89		39		

**LOW DROPOUT LINEAR REGULATOR****AZ1117B****Electrical Characteristics (Continued)****AZ1117B-2.5 Electrical Characteristics**

Operating Conditions: $V_{IN} \leq 10V$, $I_{OUT} = 10mA$, $T_J = 25^\circ C$, unless otherwise specified. ($P \leq$ maximum power dissipation). Limits appearing in **Boldface** type apply over the entire junction temperature range for operation, $-20^\circ C$ to $125^\circ C$.

Parameter	Symbol	Conditions	Min	Typ	Max	Unit	
Output Voltage	V_{OUT}		2.475	2.5	2.525	V	
		$4.5V \leq V_{IN} \leq 10V$	2.455	2.5	2.545		
Line Regulation	V_{RLINE}	$1.5V \leq V_{IN} - V_{OUT} \leq 10V$		0.5	6	mV	
					10		
Load Regulation	V_{RLOAD}			2	15	mV	
Dropout Voltage	V_{DROP}	$\Delta V_{OUT} = 1\%$, $I_{OUT} = 0.8A$	SOT-223		1.2	1.3	V
			SOT-89		1.2		
Current Limit	I_{LIMIT}		0.85	1	1.15	A	
Quiescent Current	I_Q	$I_{OUT} = 0$		4	6	mA	
Ripple Rejection	PSRR	$f = 120Hz$, $C_{OUT} = 22\mu F$ $(V_{IN} - V_{OUT}) = 3V$, $I_{OUT} = 300mA$		70		dB	
Temperature Stability				0.5		%	
RMS Output Noise (% of V_{OUT})		$T_A = 25^\circ C$, $10Hz \leq f \leq 10KHz$		0.003		%	
Thermal Shutdown		Junction Temperature		160		$^\circ C$	
Thermal Shutdown Hysteresis				16		$^\circ C$	
Thermal Resistance	θ_{JC}	SOT-223		33		$^\circ C/W$	
		SOT-89		39			

**LOW DROPOUT LINEAR REGULATOR****AZ1117B****Electrical Characteristics (Continued)****AZ1117B-3.3 Electrical Characteristics**

Operating Conditions: $V_{IN} \leq 10V$, $I_{OUT} = 10mA$, $T_J = 25^\circ C$, unless otherwise specified. ($P \leq$ maximum power dissipation). Limits appearing in **Boldface** type apply over the entire junction temperature range for operation, $-20^\circ C$ to $125^\circ C$.

Parameter	Symbol	Conditions	Min	Typ	Max	Unit	
Output Voltage	V_{OUT}		3.267	3.3	3.333	V	
		$5.3V \leq V_{IN} \leq 10V$	3.235	3.3	3.365		
Line Regulation	V_{RLINE}	$1.5V \leq V_{IN} - V_{OUT} \leq 10V$		0.5	6	mV	
					10		
Load Regulation	V_{RLOAD}			2	15	mV	
Dropout Voltage	V_{DROP}	$\Delta V_{OUT} = 1\%$, $I_{OUT} = 0.8A$	SOT-223		1.2	1.3	V
			SOT-89		1.2		
Current Limit	I_{LIMIT}		0.85	1	1.15	A	
Quiescent Current	I_Q	$I_{OUT} = 0$		4	6	mA	
Ripple Rejection	PSRR	$f = 120Hz$, $C_{OUT} = 22\mu F$ $(V_{IN} - V_{OUT}) = 3V$, $I_{OUT} = 300mA$		70		dB	
Temperature Stability				0.5		%	
RMS Output Noise (% of V_{OUT})		$T_A = 25^\circ C$, $10Hz \leq f \leq 10KHz$		0.003		%	
Thermal Shutdown		Junction Temperature		160		$^\circ C$	
Thermal Shutdown Hysteresis				16		$^\circ C$	
Thermal Resistance	θ_{JC}	SOT-223		33		$^\circ C/W$	
		SOT-89		39			

**LOW DROPOUT LINEAR REGULATOR****AZ1117B****Electrical Characteristics (Continued)****AZ1117B-5.0 Electrical Characteristics**

Operating Conditions: $V_{IN} \leq 10V$, $I_{OUT} = 10mA$, $T_J = 25^\circ C$, unless otherwise specified. ($P \leq$ maximum power dissipation). Limits appearing in **Boldface** type apply over the entire junction temperature range for operation, $-20^\circ C$ to $125^\circ C$.

Parameter	Symbol	Conditions	Min	Typ	Max	Unit	
Output Voltage	V_{OUT}		4.950	5.0	5.050	V	
		$6.5V \leq V_{IN} \leq 10V$	4.900	5.0	5.100		
Line Regulation	V_{RLINE}	$1.5V \leq V_{IN} - V_{OUT} \leq 10V$		0.5	6	mV	
				10			
Load Regulation	V_{RLOAD}			2	15	mV	
Dropout Voltage	V_{DROP}	$\Delta V_{OUT} = 1\%$, $I_{OUT} = 0.8A$	SOT-223		1.2	1.3	V
			SOT-89		1.2		
Current Limit	I_{LIMIT}		0.85	1	1.15	A	
Quiescent Current	I_Q	$I_{OUT} = 0$		4	6	mA	
Ripple Rejection	PSRR	$f = 120Hz$, $C_{OUT} = 22\mu F$ $(V_{IN} - V_{OUT}) = 3V$, $I_{OUT} = 300mA$		70		dB	
Temperature Stability				0.5		%	
RMS Output Noise (% of V_{OUT})		$T_A = 25^\circ C$, $10Hz \leq f \leq 10KHz$		0.003		%	
Thermal Shutdown		Junction Temperature		160		$^\circ C$	
Thermal Shutdown Hysteresis				16		$^\circ C$	
Thermal Resistance	θ_{JC}	SOT-223		33		$^\circ C/W$	
		SOT-89		39			



LOW DROPOUT LINEAR REGULATOR

AZ1117B

Typical Performance Characteristics

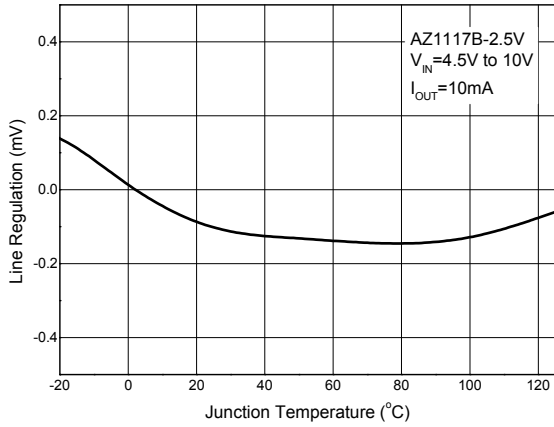

Figure 4. Line Regulation vs. Junction Temperature

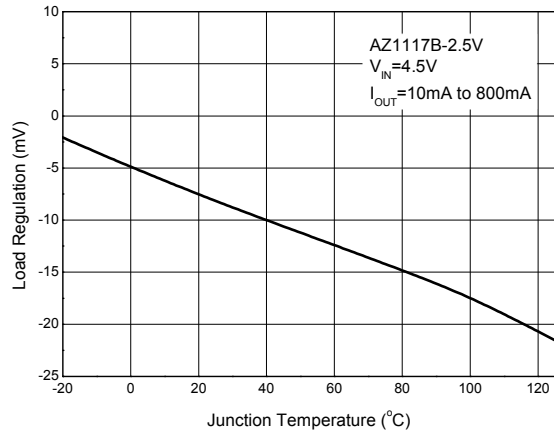

Figure 5. Load Regulation vs. Junction Temperature

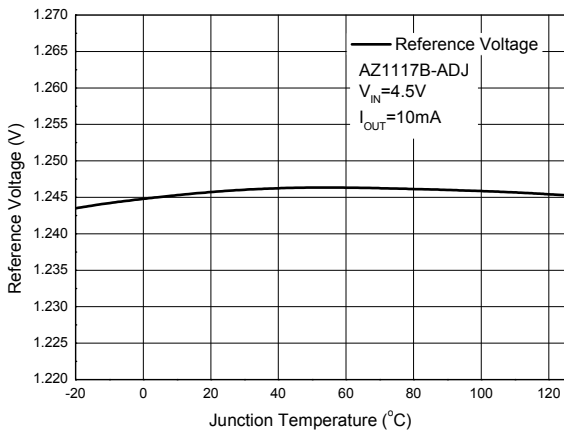

Figure 6. Reference Voltage vs. Junction Temperature

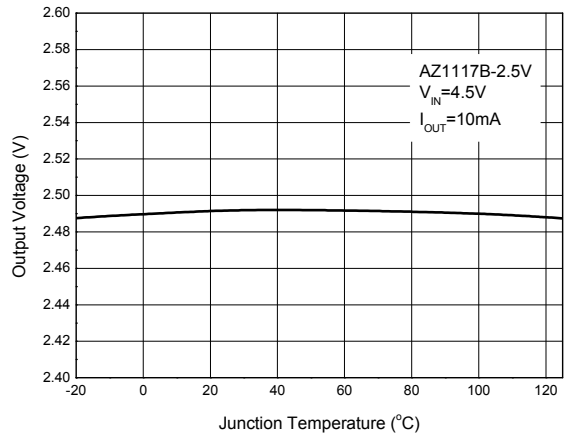

Figure 7. Output Voltage vs. Junction Temperature



LOW DROPOUT LINEAR REGULATOR

AZ1117B

Typical Performance Characteristics (Continued)

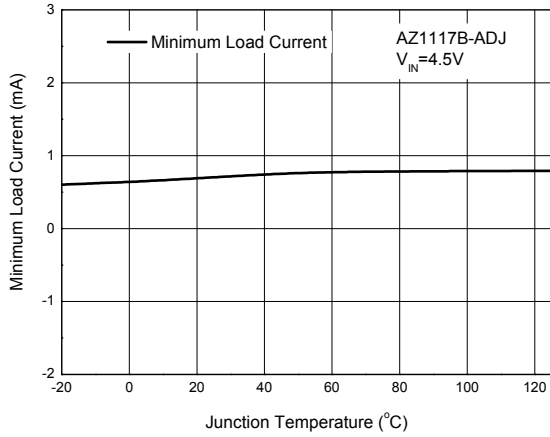

Figure 8. Minimum Load Current vs. Junction Temperature

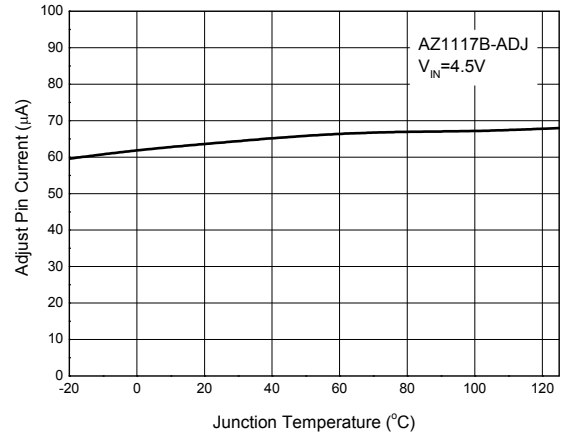

Figure 9. Adjust Pin Current vs. Junction Temperature

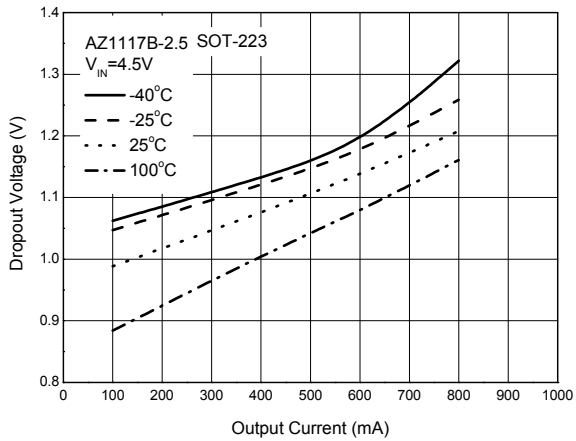

Figure 10. Dropout Voltage vs. Output Current

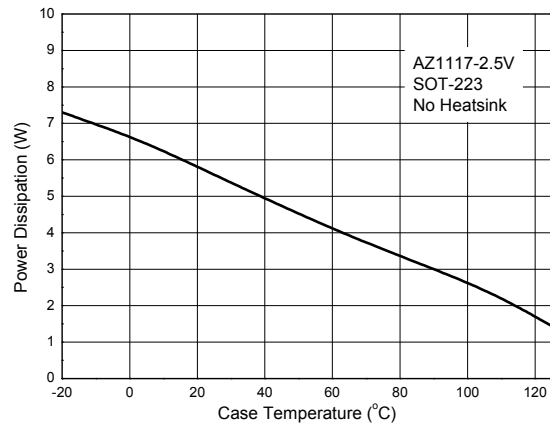

Figure 11. Power Dissipation vs. Case Temperature



LOW DROPOUT LINEAR REGULATOR

AZ1117B

Typical Performance Characteristics (Continued)

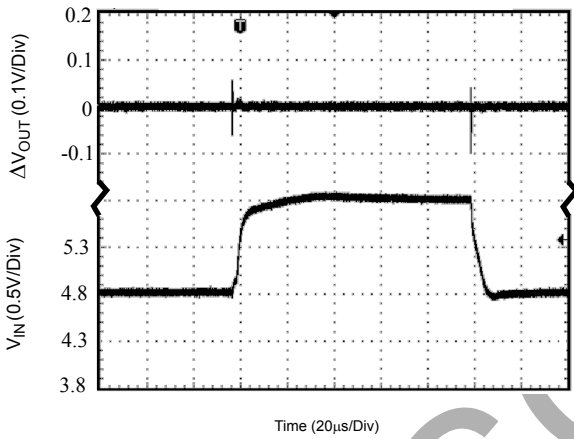

Figure 12. Line Transient Response

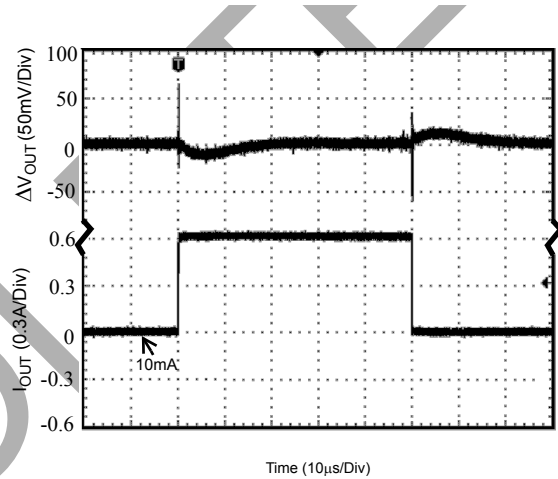

Figure 13. Load Transient Response

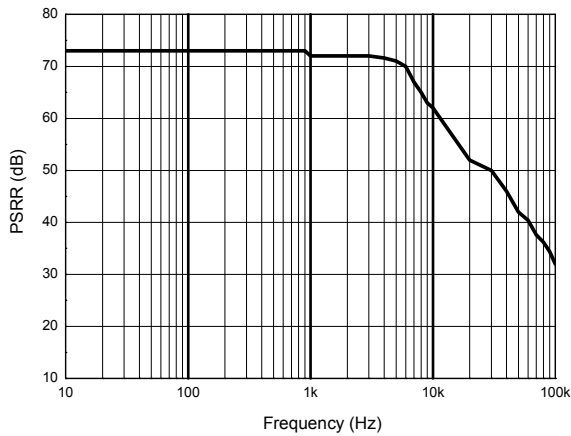

Figure 14. PSRR vs. Frequency

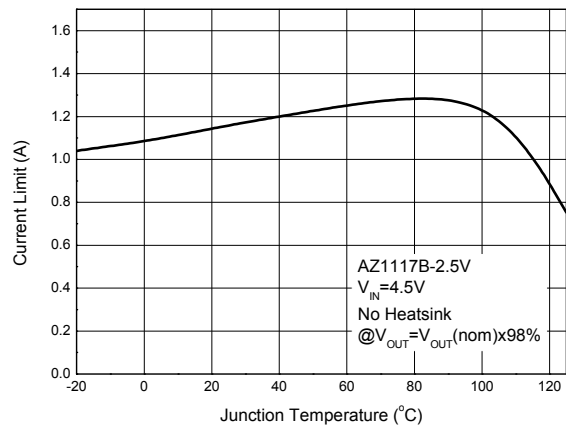

Figure 15. Current Limit vs. Junction Temperature



LOW DROPOUT LINEAR REGULATOR

AZ1117B

Typical Performance Characteristics (Continued)

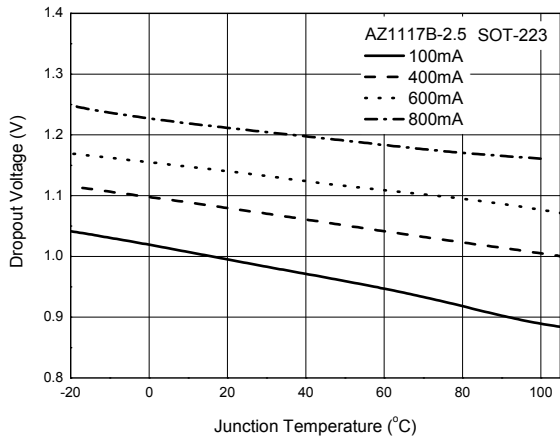

Figure 16. Dropout Voltage vs. Junction Temperature



LOW DROPOUT LINEAR REGULATOR

AZ1117B

Typical Applications

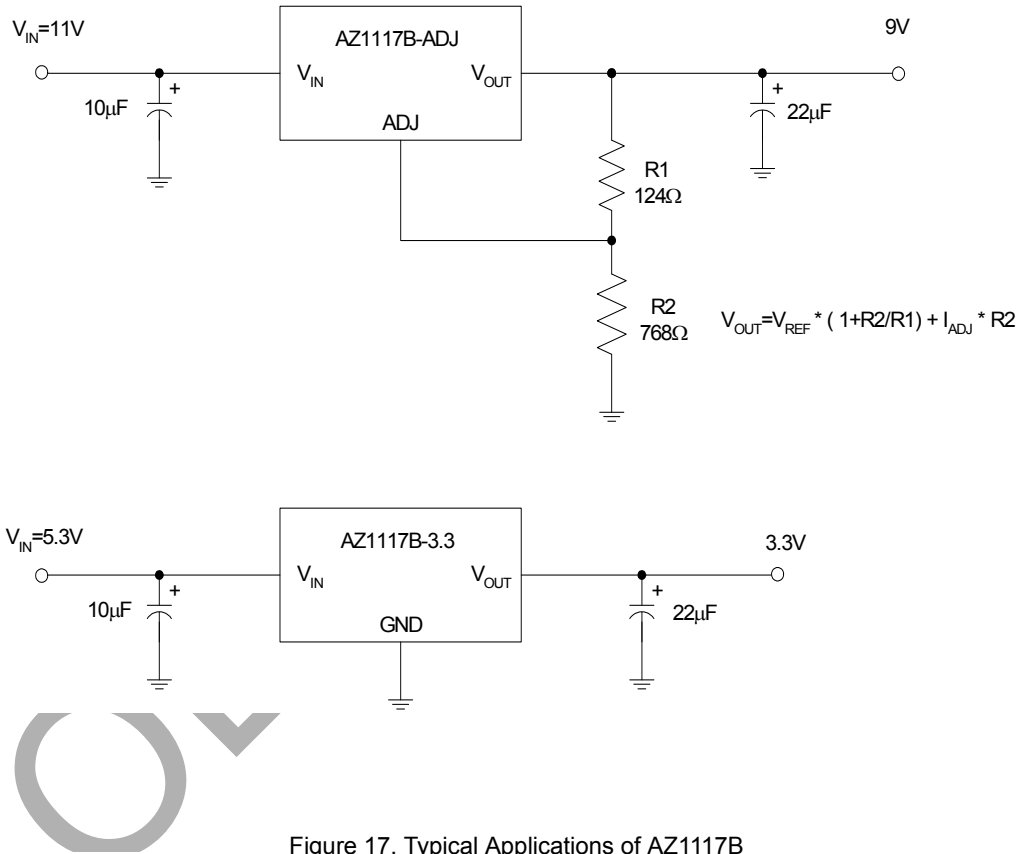

Figure 17. Typical Applications of AZ1117B



LOW DROPOUT LINEAR REGULATOR

AZ1117B

Mechanical Dimensions

SOT-223

Unit: mm(inch)

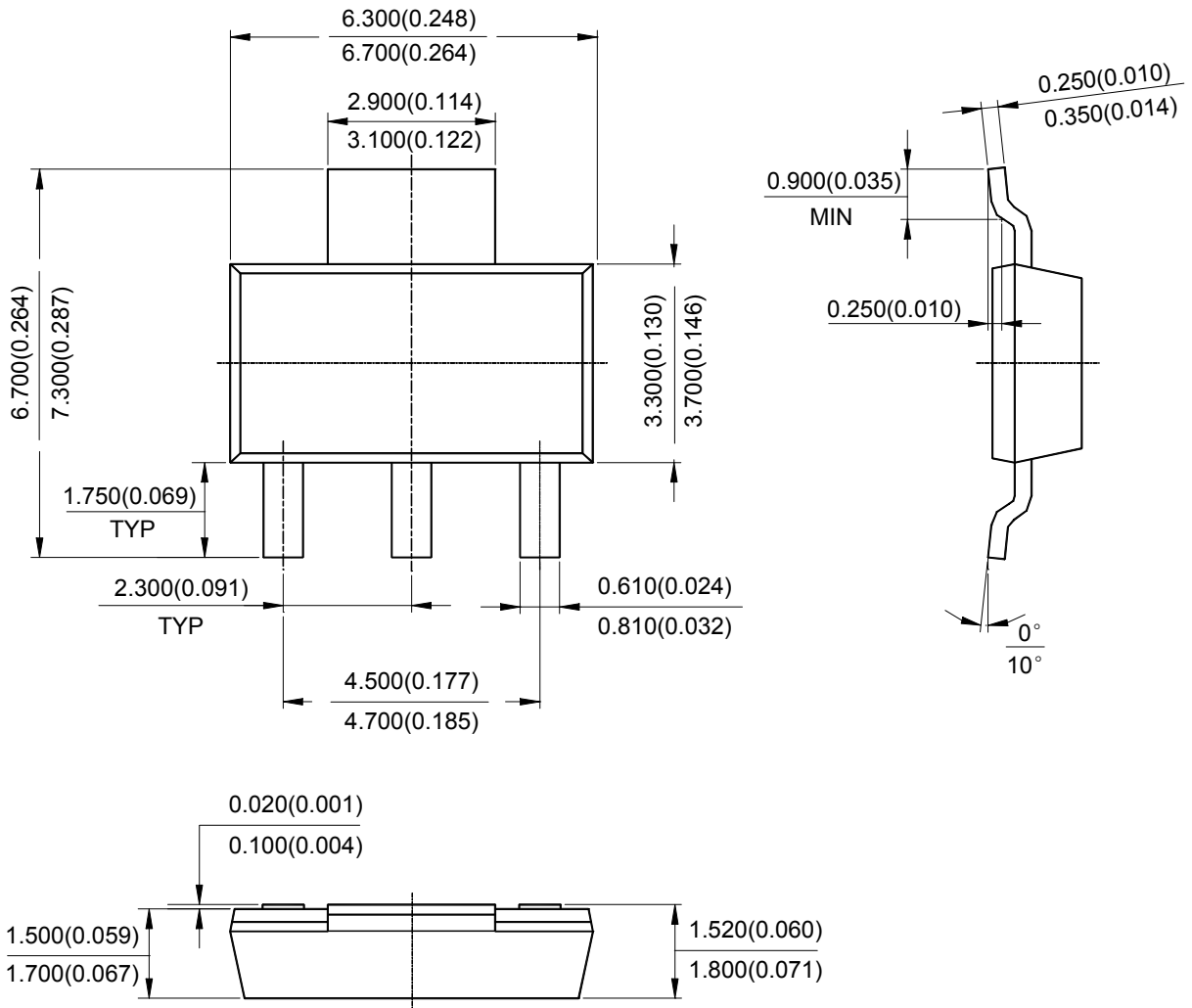

Part Obsolete



BCD Semiconductor Manufacturing Limited

<http://www.bcdsemi.com>

IMPORTANT NOTICE

BCD Semiconductor Manufacturing Limited reserves the right to make changes without further notice to any products or specifications herein. BCD Semiconductor Manufacturing Limited does not assume any responsibility for use of any its products for any particular purpose, nor does BCD Semiconductor Manufacturing Limited assume any liability arising out of the application or use of any its products or circuits. BCD Semiconductor Manufacturing Limited does not convey any license under its patent rights or other rights nor the rights of others.

MAIN SITE

- Headquarters

BCD Semiconductor Manufacturing Limited

No. 1600, Zi Xing Road, Shanghai Zizhu Science-based Industrial Park, 200241, China
Tel: +86-21-24162266, Fax: +86-21-24162277

- Wafer Fab

Shanghai SIM-BCD Semiconductor Manufacturing Co., Ltd.

800 Yi Shan Road, Shanghai 200233, China
Tel: +86-21-6485 1491, Fax: +86-21-5450 0008

REGIONAL SALES OFFICE

Shenzhen Office

Shanghai SIM-BCD Semiconductor Manufacturing Co., Ltd., Shenzhen Office

Unit A Room 1203, Skyworth Bldg., Gaoxin Ave. 1.S., Nanshan District, Shenzhen, China

Tel: +86-755-8826 7951

Fax: +86-755-8826 7865

Taiwan Office

BCD Semiconductor (Taiwan) Company Limited

4F, 298-1, Rui Guang Road, Nei-Hu District, Taipei, Taiwan

Tel: +886-2-2656 2808

Fax: +886-2-2656 2806

USA Office

BCD Semiconductor Corp.



30920 Huntwood Ave. Hayward, CA 94544, USA

Tel : +1-510-324-2988

Fax: +1-510-324-2788

Looking for pricing, stock, or lifecycle information?

Click below to explore more details on WIN SOURCE:

-  [View AZ1117BH-1.8TRE1 on WIN SOURCE](#)
-  [Diodes Incorporated Information](#)

Optimize Your Supply Chain with WIN SOURCE Solutions

-  Global Sourcing Solution
-  Obsolete Management
-  Cost Control Management
-  Shortage Management
-  Alternative Solution
-  Excess Inventory Management