



**THE DATASHEET OF
AZ1117H-1.2TRG1**



**1A LOW DROPOUT LINEAR REGULATOR****AZ1117****General Description**

The AZ1117 is a series of low dropout three-terminal regulators with a dropout of 1.15V at 1A output current.

The AZ1117 series provides current limiting and thermal shutdown. Its circuit includes a trimmed bandgap reference to assure output voltage accuracy to be within 1% for 1.5V, 1.8V, 2.5V, 2.85V, 3.3V, 5.0V and adjustable versions or 2% for 1.2V version. Current limit is trimmed to ensure specified output current and controlled short-circuit current. On-chip thermal shutdown provides protection against any combination of overload and ambient temperature that would create excessive junction temperature.

The AZ1117 has an adjustable version, that can provide the output voltage from 1.25V to 12V with only 2 external resistors.

The AZ1117 series is available in the industry standard SOT-223, SOT-89, TO-220-3, TO-252-2 (1) and TO-263-3 power packages.

Features

- Low Dropout Voltage: 1.15V at 1A Output Current
- Trimmed Current Limit
- On-chip Thermal Shutdown
- Three-terminal Adjustable or Fixed 1.2V, 1.5V, 1.8V, 2.5V, 2.85V, 3.3V, 5.0V
- Operation Junction Temperature: -40 to 125°C

Applications

- PC Motherboard
- LCD Monitor
- Graphic Card
- DVD-video Player
- NIC/Switch
- Telecom Equipment
- ADSL Modem
- Printer and other Peripheral Equipment

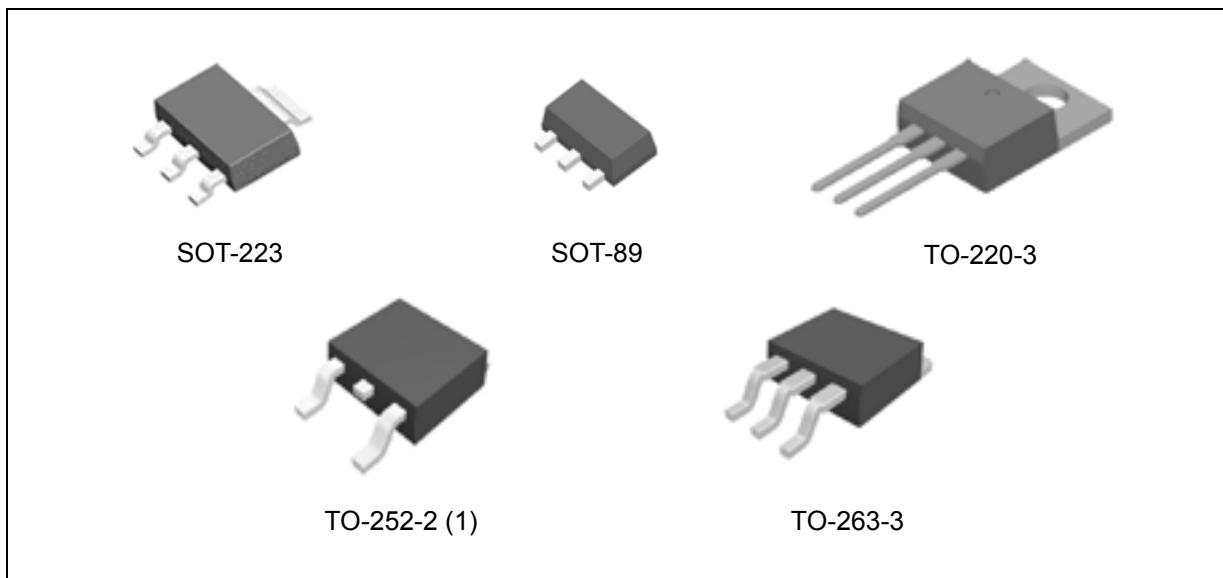

Figure 1. Package Types of AZ1117

1A LOW DROPOUT LINEAR REGULATOR**AZ1117****Pin Configuration**

Figure 2. Pin Configuration of AZ1117

1A LOW DROPOUT LINEAR REGULATOR

AZ1117

Functional Block Diagram

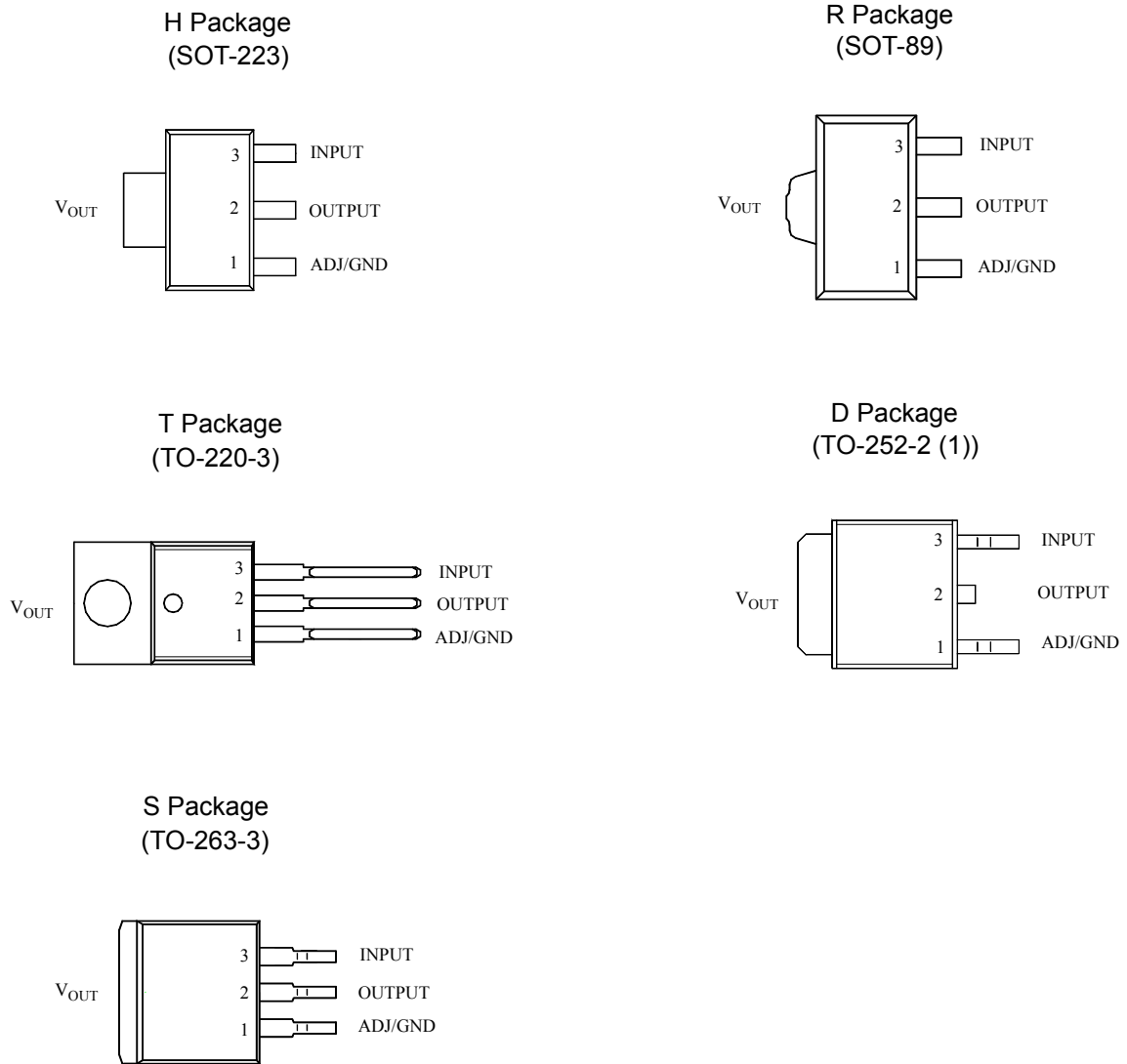
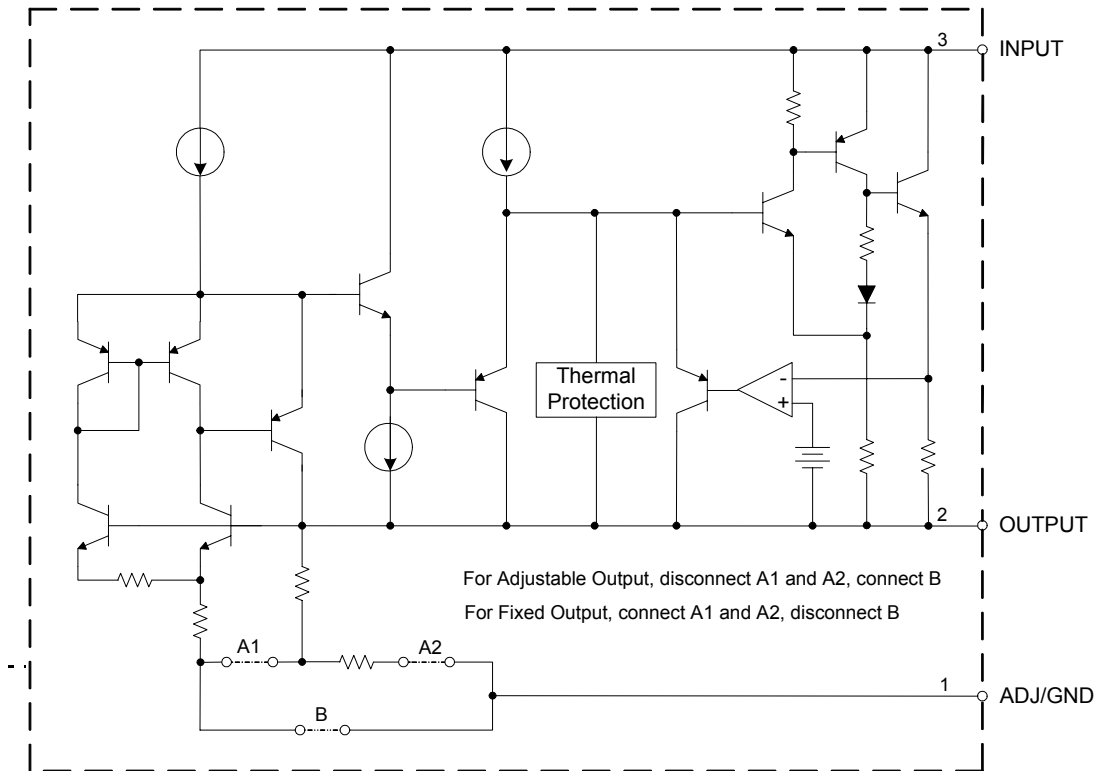

Figure 3. Functional Block Diagram of AZ1117



1A LOW DROPOUT LINEAR REGULATOR

AZ1117

Ordering Information

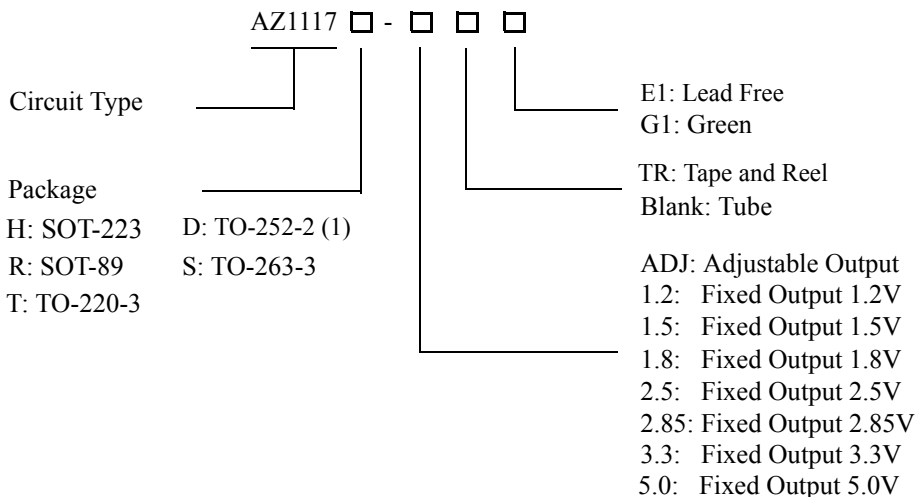

Package	Temperature Range	Part Number		Marking ID		Packing Type
		Lead Free	Green	Lead Free	Green	
SOT-223	-40 to 125°C	AZ1117H-ADJTRE1	AZ1117H-ADJTRG1	EH11A	GH11A	Tape & Reel
		AZ1117H-1.2TRE1	AZ1117H-1.2TRG1	EH18A	GH18A	Tape & Reel
		AZ1117H-1.5TRE1	AZ1117H-1.5TRG1	EH12A	GH12A	Tape & Reel
		AZ1117H-1.8TRE1	AZ1117H-1.8TRG1	EH13A	GH13A	Tape & Reel
		AZ1117H-2.5TRE1	AZ1117H-2.5TRG1	EH14A	GH14A	Tape & Reel
		AZ1117H-2.85TRE1	AZ1117H-2.85TRG1	EH15A	GH15A	Tape & Reel
		AZ1117H-3.3TRE1	AZ1117H-3.3TRG1	EH16A	GH16A	Tape & Reel
		AZ1117H-5.0TRE1	AZ1117H-5.0TRG1	EH17A	GH17A	Tape & Reel
SOT-89	-40 to 125°C	AZ1117R-ADJTRE1	AZ1117R-ADJTRG1	E17A	G17A	Tape & Reel
		AZ1117R-1.2TRE1	AZ1117R-1.2TRG1	E17G	G17G	Tape & Reel
		AZ1117R-1.5TRE1	AZ1117R-1.5TRG1	E17B	G17B	Tape & Reel
		AZ1117R-1.8TRE1	AZ1117R-1.8TRG1	E17C	G17C	Tape & Reel
		AZ1117R-2.5TRE1	AZ1117R-2.5TRG1	E17D	G17D	Tape & Reel
		AZ1117R-2.85TRE1	AZ1117R-2.85TRG1	E17H	G17H	Tape & Reel
		AZ1117R-3.3TRE1	AZ1117R-3.3TRG1	E17E	G17E	Tape & Reel
		AZ1117R-5.0TRE1	AZ1117R-5.0TRG1	E17F	G17F	Tape & Reel
TO-220-3	-40 to 125°C	AZ1117T-ADJE1	AZ1117T-ADJG1	AZ1117T-ADJE1	AZ1117T-ADJG1	Tube
		AZ1117T-1.2E1	AZ1117T-1.2G1	AZ1117T-1.2E1	AZ1117T-1.2G1	Tube
		AZ1117T-1.5E1	AZ1117T-1.5G1	AZ1117T-1.5E1	AZ1117T-1.5G1	Tube
		AZ1117T-1.8E1	AZ1117T-1.8G1	AZ1117T-1.8E1	AZ1117T-1.8G1	Tube
		AZ1117T-2.5E1	AZ1117T-2.5G1	AZ1117T-2.5E1	AZ1117T-2.5G1	Tube
		AZ1117T-2.85E1	AZ1117T-2.85G1	AZ1117T-2.85E1	AZ1117T-2.85G1	Tube
		AZ1117T-3.3E1	AZ1117T-3.3G1	AZ1117T-3.3E1	AZ1117T-3.3G1	Tube
		AZ1117T-5.0E1	AZ1117T-5.0G1	AZ1117T-5.0E1	AZ1117T-5.0G1	Tube



1A LOW DROPOUT LINEAR REGULATOR AZ1117

Ordering Information (Continued)

Package	Temperature Range	Part Number		Marking ID		Packing Type
		Lead Free	Green	Lead Free	Green	
TO-252-2 (1)	-40 to 125°C	AZ1117D-ADJE1	AZ1117D-ADJG1	AZ1117D-ADJE1	AZ1117D-ADJG1	Tube
		AZ1117D-ADJTRE1	AZ1117D-ADJTRG1	AZ1117D-ADJE1	AZ1117D-ADJG1	Tape & Reel
		AZ1117D-1.2E1	AZ1117D-1.2G1	AZ1117D-1.2E1	AZ1117D-1.2G1	Tube
		AZ1117D-1.2TRE1	AZ1117D-1.2TRG1	AZ1117D-1.2E1	AZ1117D-1.2G1	Tape & Reel
		AZ1117D-1.5E1	AZ1117D-1.5G1	AZ1117D-1.5E1	AZ1117D-1.5G1	Tube
		AZ1117D-1.5TRE1	AZ1117D-1.5TRG1	AZ1117D-1.5E1	AZ1117D-1.5G1	Tape & Reel
		AZ1117D-1.8E1	AZ1117D-1.8G1	AZ1117D-1.8E1	AZ1117D-1.8G1	Tube
		AZ1117D-1.8TRE1	AZ1117D-1.8TRG1	AZ1117D-1.8E1	AZ1117D-1.8G1	Tape & Reel
		AZ1117D-2.5E1	AZ1117D-2.5G1	AZ1117D-2.5E1	AZ1117D-2.5G1	Tube
		AZ1117D-2.5TRE1	AZ1117D-2.5TRG1	AZ1117D-2.5E1	AZ1117D-2.5G1	Tape & Reel
		AZ1117D-2.85E1	AZ1117D-2.85G1	AZ1117D-2.85E1	AZ1117D-2.85G1	Tube
		AZ1117D-2.85TRE1	AZ1117D-2.85TRG1	AZ1117D-2.85E1	AZ1117D-2.85G1	Tape & Reel
		AZ1117D-3.3E1	AZ1117D-3.3G1	AZ1117D-3.3E1	AZ1117D-3.3G1	Tube
		AZ1117D-3.3TRE1	AZ1117D-3.3TRG1	AZ1117D-3.3E1	AZ1117D-3.3G1	Tape & Reel
		AZ1117D-5.0E1	AZ1117D-5.0G1	AZ1117D-5.0E1	AZ1117D-5.0G1	Tube
		AZ1117D-5.0TRE1	AZ1117D-5.0TRG1	AZ1117D-5.0E1	AZ1117D-5.0G1	Tape & Reel
TO-263-3	-40 to 125°C	AZ1117S-ADJE1	AZ1117S-ADJG1	AZ1117S-ADJE1	AZ1117S-ADJG1	Tube
		AZ1117S-ADJTRE1	AZ1117S-ADJTRG1	AZ1117S-ADJE1	AZ1117S-ADJG1	Tape & Reel
		AZ1117S-1.2E1	AZ1117S-1.2G1	AZ1117S-1.2E1	AZ1117S-1.2G1	Tube
		AZ1117S-1.2TRE1	AZ1117S-1.2TRG1	AZ1117S-1.2E1	AZ1117S-1.2G1	Tape & Reel
		AZ1117S-1.5E1	AZ1117S-1.5G1	AZ1117S-1.5E1	AZ1117S-1.5G1	Tube
		AZ1117S-1.5TRE1	AZ1117S-1.5TRG1	AZ1117S-1.5E1	AZ1117S-1.5G1	Tape & Reel
		AZ1117S-1.8E1	AZ1117S-1.8G1	AZ1117S-1.8E1	AZ1117S-1.8G1	Tube
		AZ1117S-1.8TRE1	AZ1117S-1.8TRG1	AZ1117S-1.8E1	AZ1117S-1.8G1	Tape & Reel
		AZ1117S-2.5E1	AZ1117S-2.5G1	AZ1117S-2.5E1	AZ1117S-2.5G1	Tube
		AZ1117S-2.5TRE1	AZ1117S-2.5TRG1	AZ1117S-2.5E1	AZ1117S-2.5G1	Tape & Reel
		AZ1117S-2.85E1	AZ1117S-2.85G1	AZ1117S-2.85E1	AZ1117S-2.85G1	Tube
		AZ1117S-2.85TRE1	AZ1117S-2.85TRG1	AZ1117S-2.85E1	AZ1117S-2.85G1	Tape & Reel
		AZ1117S-3.3E1	AZ1117S-3.3G1	AZ1117S-3.3E1	AZ1117S-3.3G1	Tube
		AZ1117S-3.3TRE1	AZ1117S-3.3TRG1	AZ1117S-3.3E1	AZ1117S-3.3G1	Tape & Reel
		AZ1117S-5.0E1	AZ1117S-5.0G1	AZ1117S-5.0E1	AZ1117S-5.0G1	Tube
		AZ1117S-5.0TRE1	AZ1117S-5.0TRG1	AZ1117S-5.0E1	AZ1117S-5.0G1	Tape & Reel

BCD Semiconductor's Pb-free products, as designated with "E1" suffix in the part number, are RoHS compliant. Products with "G1" suffix are available in green packages.

**1A LOW DROPOUT LINEAR REGULATOR****AZ1117****Absolute Maximum Ratings (Note 1)**

Parameter	Symbol	Value	Unit	
Input Voltage	V_{IN}	20	V	
Operating Junction Temperature	T_J	150	°C	
Storage Temperature	T_S	-65 to 150	°C	
Lead Temperature (Soldering, 10sec)	T_{LEAD}	260	°C	
Thermal Resistance (No Heatsink, Note 2)	θ_{JA}	SOT-223	120	°C/W
		SOT-89	165	
		TO-220-3	60	
		TO-252-2 (1)	100	
		TO-263-3	60	
ESD (Human Body Model)	ESD	2000	V	
ESD (Machine Model)	ESD	250	V	

Note 1: Stresses greater than those listed under "Absolute Maximum Ratings" may cause permanent damage to the device. These are stress ratings only, and functional operation of the device at these or any other conditions beyond those indicated under "Recommended Operating Conditions" is not implied. Exposure to "Absolute Maximum Ratings" for extended periods may affect device reliability.

Note 2: Absolute maximum ratings indicate limits beyond which damage to the component may occur. Electrical specifications do not apply when operating the device outside of its operating ratings. The maximum allowable power dissipation is a function of the maximum junction temperature, $T_{J(max)}$, the junction-to-ambient thermal resistance, θ_{JA} , and the ambient temperature, T_A . The maximum allowable power dissipation at any ambient temperature is calculated using: $P_{D(max)} = (T_{J(max)} - T_A) / \theta_{JA}$. Exceeding the maximum allowable power dissipation will result in excessive die temperature, and the regulator will go into thermal shutdown.

Recommended Operating Conditions

Parameter	Symbol	Min	Max	Unit
Input Voltage	V_{IN}		15	V
Operating Junction Temperature Range	T_J	-40	125	°C

**1A LOW DROPOUT LINEAR REGULATOR****AZ1117****Electrical Characteristics****AZ1117-ADJ Electrical Characteristics**Operating Conditions: $V_{IN} \leq 10V$, $T_J = 25^\circ C$, unless otherwise specified.

Parameter	Symbol	Conditions	Min	Typ	Max	Unit
Reference Voltage	V_{REF}	$I_{OUT} = 10mA$, $V_{IN} - V_{OUT} = 2V$ $10mA \leq I_{OUT} \leq 1A$, $1.4V \leq V_{IN} - V_{OUT} \leq 8V$, $P \leq$ Maximum Power Dissipation	1.238 1.225	1.250 1.250	1.262 1.270	V
Line Regulation	ΔV_{OUT}	$I_{OUT} = 10mA$, $1.5V \leq V_{IN} - V_{OUT} \leq 10V$		0.035	0.2	%
Load Regulation	ΔV_{OUT}	$V_{IN} - V_{OUT} = 2V$, $10mA \leq I_{OUT} \leq 1A$		0.2	0.4	%
Dropout Voltage	V_{DROP}	$\Delta V_{REF} = 1\%$, $I_{OUT} = 0.1A$		1.00	1.1	V
		$\Delta V_{REF} = 1\%$, $I_{OUT} = 0.5A$		1.08	1.18	V
		$\Delta V_{REF} = 1\%$, $I_{OUT} = 1.0A$		1.15	1.25	V
Current Limit	I_{LIMIT}	$V_{IN} - V_{OUT} = 2V$	1.25	1.35		A
Adjust Pin Current	I_{ADJ}			60	120	μA
Adjust Pin Current Change	ΔI_{ADJ}	$1.4V \leq V_{IN} - V_{OUT} \leq 10V$, $10mA \leq I_{OUT} \leq 1A$		0.2	5	μA
Minimum Load Current (ADJ)	$I_{LOAD(MIN)}$	$1.5V \leq V_{IN} - V_{OUT} \leq 10V$ (ADJ only)		1.7	5	mA
Quiescent Current	I_Q	$V_{IN} = V_{OUT} + 1.25V$		5	10	mA
Ripple Rejection	PSRR	$f = 120Hz$, $C_{OUT} = 22\mu F$ Tantalum, $V_{IN} - V_{OUT} = 3V$, $I_{OUT} = 1A$	60	75		dB
Temperature Stability				0.5		%
Long-term Stability		$T_A = 125^\circ C$, 1000hrs		0.3		%
RMS Output Noise (% of V_{OUT})		$T_A = 25^\circ C$, $10Hz \leq f \leq 10kHz$		0.003		%
Thermal Shutdown		Junction Temperature		150		$^\circ C$
Thermal Shutdown Hysteresis				25		$^\circ C$

**1A LOW DROPOUT LINEAR REGULATOR****AZ1117****Electrical Characteristics (Continued)****AZ1117-1.2 Electrical Characteristics**Operating Conditions: $V_{IN} \leq 10V$, $T_J = 25^\circ C$, unless otherwise specified.

Parameter	Symbol	Conditions	Min	Typ	Max	Unit
Output Voltage	V_{OUT}	$I_{OUT} = 10mA$, $V_{IN} = 3.2V$ $10mA \leq I_{OUT} \leq 1A$, $3.0V \leq V_{IN} \leq 10V$	1.176 1.152	1.2 1.2	1.224 1.248	V
Line Regulation	ΔV_{OUT}	$I_{OUT} = 10mA$, $1.5V \leq V_{IN} - V_{OUT} \leq 10V$		1	6	mV
Load Regulation	ΔV_{OUT}	$V_{IN} - V_{OUT} = 2V$, $10mA \leq I_{OUT} \leq 1A$		1	10	mV
Dropout Voltage	V_{DROP}	$\Delta V_{OUT} = 1\%$, $I_{OUT} = 0.1A$		1.00	1.1	V
		$\Delta V_{OUT} = 1\%$, $I_{OUT} = 0.5A$		1.08	1.18	V
		$\Delta V_{OUT} = 1\%$, $I_{OUT} = 1.0A$		1.15	1.25	V
Current Limit	I_{LIMIT}	$V_{IN} - V_{OUT} = 2V$	1.25	1.35		A
Quiescent Current	I_Q	$V_{IN} = V_{OUT} + 1.25V$		5	10	mA
Ripple Rejection	PSRR	$f = 120Hz$, $C_{OUT} = 22\mu F$ Tantalum, $V_{IN} - V_{OUT} = 3V$, $I_{OUT} = 1A$	60	75		dB
Temperature Stability				0.5		%
Long-term Stability		$T_A = 125^\circ C$, 1000hrs		0.3		%
RMS Output Noise (% of V_{OUT})		$T_A = 25^\circ C$, $10Hz \leq f \leq 10kHz$		0.003		%
Thermal Shutdown		Junction Temperature		150		$^\circ C$
Thermal Shutdown Hysteresis				25		$^\circ C$

**1A LOW DROPOUT LINEAR REGULATOR****AZ1117****Electrical Characteristics (Continued)****AZ1117-1.5 Electrical Characteristics**Operating Conditions: $V_{IN} \leq 10V$, $T_J = 25^\circ C$, unless otherwise specified.

Parameter	Symbol	Conditions	Min	Typ	Max	Unit
Output Voltage	V_{OUT}	$I_{OUT}=10mA$, $V_{IN}=3.5V$ $10mA \leq I_{OUT} \leq 1A$, $3.0V \leq V_{IN} \leq 10V$	1.485 1.470	1.5 1.5	1.515 1.530	V
Line Regulation	ΔV_{OUT}	$I_{OUT}=10mA$, $1.5V \leq V_{IN}-V_{OUT} \leq 10V$		1	6	mV
Load Regulation	ΔV_{OUT}	$V_{IN}-V_{OUT}=2V$, $10mA \leq I_{OUT} \leq 1A$		1	10	mV
Dropout Voltage	V_{DROP}	$\Delta V_{OUT}=1\%$, $I_{OUT}=0.1A$		1.00	1.1	V
		$\Delta V_{OUT}=1\%$, $I_{OUT}=0.5A$		1.08	1.18	V
		$\Delta V_{OUT}=1\%$, $I_{OUT}=1.0A$		1.15	1.25	V
Current Limit	I_{LIMIT}	$V_{IN}-V_{OUT}=2V$	1.25	1.35		A
Quiescent Current	I_Q	$V_{IN}=V_{OUT}+1.25V$		5	10	mA
Ripple Rejection	PSRR	$f=120Hz$, $C_{OUT}=22\mu F$ Tantalum, $V_{IN}-V_{OUT}=3V$, $I_{OUT}=1A$	60	75		dB
Temperature Stability				0.5		%
Long-term Stability		$T_A=125^\circ C$, 1000hrs		0.3		%
RMS Output Noise (% of V_{OUT})		$T_A=25^\circ C$, $10Hz \leq f \leq 10kHz$		0.003		%
Thermal Shutdown		Junction Temperature		150		$^\circ C$
Thermal Shutdown Hysteresis				25		$^\circ C$



1A LOW DROPOUT LINEAR REGULATOR

AZ1117

Electrical Characteristics (Continued)

AZ1117-1.8 Electrical Characteristics

Operating Conditions: $V_{IN} \leq 10V$, $T_J = 25^\circ C$, unless otherwise specified.

Parameter	Symbol	Conditions	Min	Typ	Max	Unit
Output Voltage	V_{OUT}	$I_{OUT} = 10mA$, $V_{IN} = 3.8V$ $10mA \leq I_{OUT} \leq 1A$, $3.2V \leq V_{IN} \leq 10V$	1.782 1.746	1.8 1.8	1.818 1.854	V
Line Regulation	ΔV_{OUT}	$I_{OUT} = 10mA$, $1.5V \leq V_{IN} - V_{OUT} \leq 10V$		1	6	mV
Load Regulation	ΔV_{OUT}	$V_{IN} - V_{OUT} = 2V$, $10mA \leq I_{OUT} \leq 1A$		1	10	mV
Dropout Voltage	V_{DROP}	$\Delta V_{OUT} = 1\%$, $I_{OUT} = 0.1A$		1.00	1.1	V
		$\Delta V_{OUT} = 1\%$, $I_{OUT} = 0.5A$		1.08	1.18	V
		$\Delta V_{OUT} = 1\%$, $I_{OUT} = 1.0A$		1.15	1.25	V
Current Limit	I_{LIMIT}	$V_{IN} - V_{OUT} = 2V$	1.25	1.35		A
Quiescent Current	I_Q	$V_{IN} = V_{OUT} + 1.25V$		5	10	mA
Ripple Rejection	PSRR	$f = 120Hz$, $C_{OUT} = 22\mu F$ Tantalum, $V_{IN} - V_{OUT} = 3V$, $I_{OUT} = 1A$	60	75		dB
Temperature Stability				0.5		%
Long-term Stability		$T_A = 125^\circ C$, 1000hrs		0.3		%
RMS Output Noise (% of V_{OUT})		$T_A = 25^\circ C$, $10Hz \leq f \leq 10kHz$		0.003		%
Thermal Shutdown		Junction Temperature		150		$^\circ C$
Thermal Shutdown Hysteresis				25		$^\circ C$

**1A LOW DROPOUT LINEAR REGULATOR****AZ1117****Electrical Characteristics (Continued)****AZ1117-2.5 Electrical Characteristics**Operating Conditions: $V_{IN} \leq 10V$, $T_J = 25^\circ C$, unless otherwise specified.

Parameter	Symbol	Conditions	Min	Typ	Max	Unit
Output Voltage	V_{OUT}	$I_{OUT} = 10mA$, $V_{IN} = 4.5V$ $10mA \leq I_{OUT} \leq 1A$, $3.9V \leq V_{IN} \leq 10V$	2.475 2.450	2.5 2.5	2.525 2.550	V
Line Regulation	ΔV_{OUT}	$I_{OUT} = 10mA$, $1.5V \leq V_{IN} - V_{OUT} \leq 10V$		1	6	mV
Load Regulation	ΔV_{OUT}	$V_{IN} - V_{OUT} = 2V$, $10mA \leq I_{OUT} \leq 1A$		1	10	mV
Dropout Voltage	V_{DROP}	$\Delta V_{OUT} = 1\%$, $I_{OUT} = 0.1A$		1.00	1.1	V
		$\Delta V_{OUT} = 1\%$, $I_{OUT} = 0.5A$		1.08	1.18	V
		$\Delta V_{OUT} = 1\%$, $I_{OUT} = 1.0A$		1.15	1.25	V
Current Limit	I_{LIMIT}	$V_{IN} - V_{OUT} = 2V$	1.25	1.35		A
Quiescent Current	I_Q	$V_{IN} = V_{OUT} + 1.25V$		5	10	mA
Ripple Rejection	PSRR	$f = 120Hz$, $C_{OUT} = 22\mu F$ Tantalum, $V_{IN} - V_{OUT} = 3V$, $I_{OUT} = 1A$	60	75		dB
Temperature Stability				0.5		%
Long-term Stability		$T_A = 125^\circ C$, 1000hrs		0.3		%
RMS Output Noise (% of V_{OUT})		$T_A = 25^\circ C$, $10Hz \leq f \leq 10kHz$		0.003		%
Thermal Shutdown		Junction Temperature		150		$^\circ C$
Thermal Shutdown Hysteresis				25		$^\circ C$



1A LOW DROPOUT LINEAR REGULATOR

AZ1117

Electrical Characteristics (Continued)

AZ1117-2.85 Electrical Characteristics

Operating Conditions: $V_{IN} \leq 10V$, $T_J = 25^\circ C$, unless otherwise specified.

Parameter	Symbol	Conditions	Min	Typ	Max	Unit
Output Voltage	V_{OUT}	$I_{OUT}=10mA$, $V_{IN}=4.85V$ $10mA \leq I_{OUT} \leq 1A$, $4.25V \leq V_{IN} \leq 10V$	2.822 2.793	2.85 2.85	2.878 2.907	V
Line Regulation	ΔV_{OUT}	$I_{OUT}=10mA$, $1.5V \leq V_{IN} - V_{OUT} \leq 10V$		1	6	mV
Load Regulation	ΔV_{OUT}	$V_{IN} - V_{OUT} = 2V$, $10mA \leq I_{OUT} \leq 1A$		1	10	mV
Dropout Voltage	V_{DROP}	$\Delta V_{REF}=1\%$, $I_{OUT}=0.1A$		1.00	1.1	V
		$\Delta V_{REF}=1\%$, $I_{OUT}=0.5A$		1.08	1.18	V
		$\Delta V_{REF}=1\%$, $I_{OUT}=1.0A$		1.15	1.25	V
Current Limit	I_{LIMIT}	$V_{IN} - V_{OUT} = 2V$	1.25	1.35		A
Quiescent Current	I_Q	$V_{IN} = V_{OUT} + 1.25V$		5	10	mA
Ripple Rejection	PSRR	$f=120Hz$, $C_{OUT}=22\mu F$ Tantalum, $V_{IN} - V_{OUT} = 3V$, $I_{OUT} = 1A$	60	75		dB
Temperature Stability				0.5		%
Long-term Stability		$T_A = 125^\circ C$, 1000hrs		0.3		%
RMS Output Noise (% of V_{OUT})		$T_A = 25^\circ C$, $10Hz \leq f \leq 10kHz$		0.003		%
Thermal Shutdown		Junction Temperature		150		$^\circ C$
Thermal Shutdown Hysteresis				25		$^\circ C$

**1A LOW DROPOUT LINEAR REGULATOR****AZ1117****Electrical Characteristics (Continued)****AZ1117-3.3 Electrical Characteristics**Operating Conditions: $V_{IN} \leq 10V$, $T_J = 25^\circ C$, unless otherwise specified.

Parameter	Symbol	Conditions	Min	Typ	Max	Unit
Output Voltage	V_{OUT}	$I_{OUT} = 10mA$, $V_{IN} = 5.0V$ $10mA \leq I_{OUT} \leq 1A$, $4.75V \leq V_{IN} \leq 10V$	3.267 3.235	3.3 3.3	3.333 3.365	V
Line Regulation	ΔV_{OUT}	$I_{OUT} = 10mA$, $1.5V \leq V_{IN} - V_{OUT} \leq 10V$		1	6	mV
Load Regulation	ΔV_{OUT}	$V_{IN} - V_{OUT} = 2V$, $10mA \leq I_{OUT} \leq 1A$		1	10	mV
Dropout Voltage	V_{DROP}	$\Delta V_{OUT} = 1\%$, $I_{OUT} = 0.1A$		1.00	1.1	V
		$\Delta V_{OUT} = 1\%$, $I_{OUT} = 0.5A$		1.08	1.18	V
		$\Delta V_{OUT} = 1\%$, $I_{OUT} = 1.0A$		1.15	1.25	V
Current Limit	I_{LIMIT}	$V_{IN} - V_{OUT} = 2V$	1.25	1.35		A
Quiescent Current	I_Q	$V_{IN} = V_{OUT} + 1.25V$		5	10	mA
Ripple Rejection	PSRR	$f = 120Hz$, $C_{OUT} = 22\mu F$ Tantalum, $V_{IN} - V_{OUT} = 3V$, $I_{OUT} = 1A$	60	75		dB
Temperature Stability				0.5		%
Long-term Stability		$T_A = 125^\circ C$, 1000hrs		0.3		%
RMS Output Noise (% of V_{OUT})		$T_A = 25^\circ C$, $10Hz \leq f \leq 10kHz$		0.003		%
Thermal Shutdown		Junction Temperature		150		$^\circ C$
Thermal Shutdown Hysteresis				25		$^\circ C$



1A LOW DROPOUT LINEAR REGULATOR

AZ1117

Electrical Characteristics (Continued)

AZ1117-5.0 Electrical Characteristics

Operating Conditions: $V_{IN} \leq 10V$, $T_J = 25^\circ C$, unless otherwise specified.

Parameter	Symbol	Conditions	Min	Typ	Max	Unit
Output Voltage	V_{OUT}	$I_{OUT} = 10mA$, $V_{IN} = 7.0V$ $10mA \leq I_{OUT} \leq 1A$, $6.5V \leq V_{IN} \leq 12V$	4.950 4.900	5.0 5.0	5.050 5.100	V
Line Regulation	ΔV_{OUT}	$I_{OUT} = 10mA$, $1.5V \leq V_{IN} - V_{OUT} \leq 10V$		1	10	mV
Load Regulation	ΔV_{OUT}	$V_{IN} - V_{OUT} = 2V$, $10mA \leq I_{OUT} \leq 1A$		1	15	mV
Dropout Voltage	V_{DROP}	$\Delta V_{OUT} = 1\%$, $I_{OUT} = 0.1A$		1.00	1.1	V
		$\Delta V_{OUT} = 1\%$, $I_{OUT} = 0.5A$		1.08	1.18	V
		$\Delta V_{OUT} = 1\%$, $I_{OUT} = 1.0A$		1.15	1.25	V
Current Limit	I_{LIMIT}	$V_{IN} - V_{OUT} = 2V$	1.25	1.35		A
Quiescent Current	I_Q	$V_{IN} = V_{OUT} + 1.25V$		5	10	mA
Ripple Rejection	PSRR	$f = 120Hz$, $C_{OUT} = 22\mu F$ Tantalum, $V_{IN} - V_{OUT} = 3V$, $I_{OUT} = 1A$	60	75		dB
Temperature Stability				0.5		%
Long-term Stability		$T_A = 125^\circ C$, 1000hrs		0.3		%
RMS Output Noise (% of V_{OUT})		$T_A = 25^\circ C$, $10Hz \leq f \leq 10kHz$		0.003		%
Thermal Shutdown		Junction Temperature		150		$^\circ C$
Thermal Shutdown Hysteresis				25		$^\circ C$



1A LOW DROPOUT LINEAR REGULATOR

AZ1117

Typical Performance Characteristics

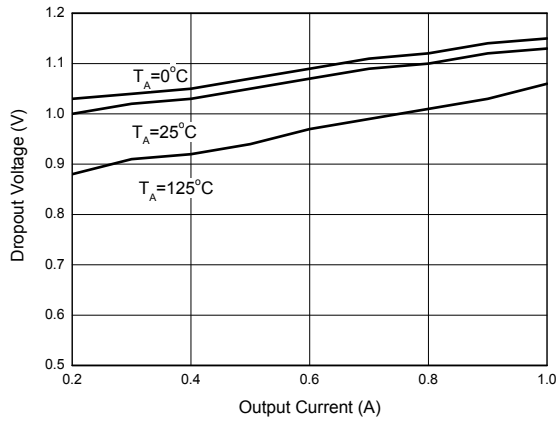

Figure 4. Dropout Voltage vs. Output Current

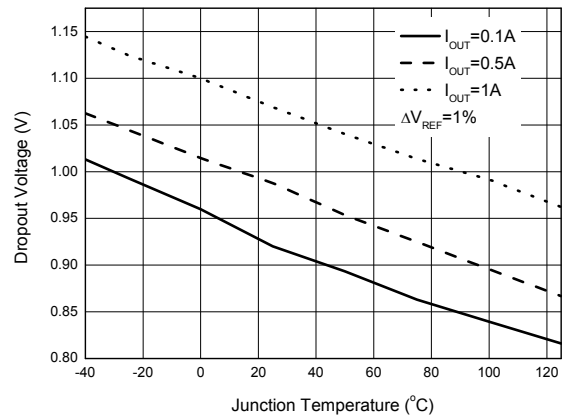

Figure 5. Dropout Voltage vs. Junction Temperature

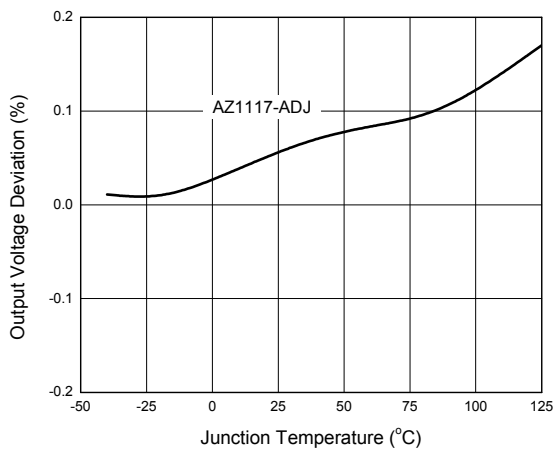

Figure 6. Load Regulation vs. Junction Temperature

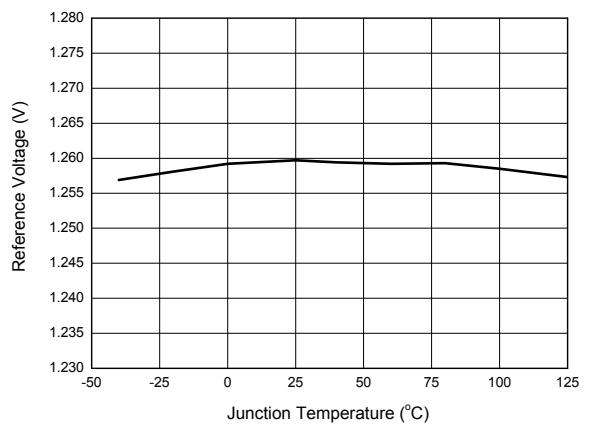

Figure 7. Reference Voltage vs. Junction Temperature



1A LOW DROPOUT LINEAR REGULATOR

AZ1117

Typical Performance Characteristics (Continued)

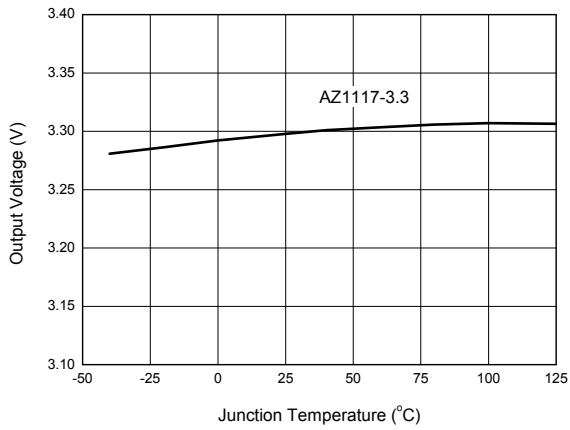

Figure 8. Output Voltage vs. Junction Temperature

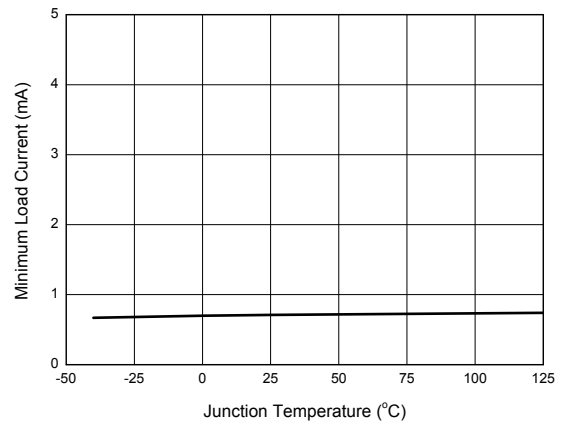

Figure 9. Minimum Load Current vs. Junction Temperature

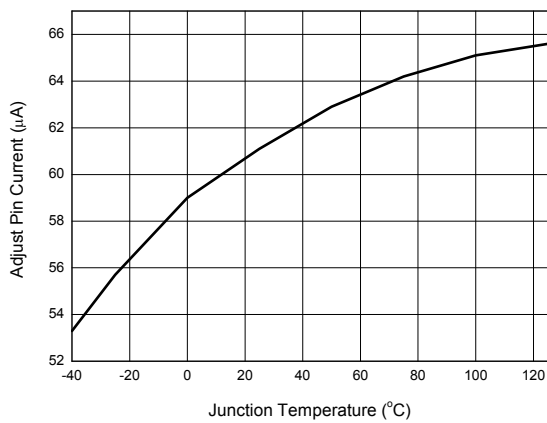

Figure 10. Adjust Pin Current vs. Junction Temperature

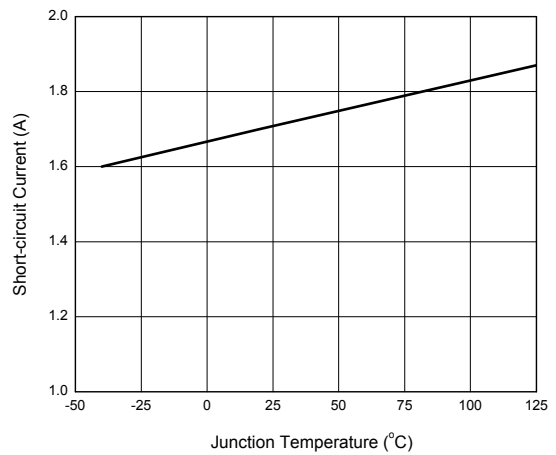

Figure 11. Short-circuit Current vs. Junction Temperature



1A LOW DROPOUT LINEAR REGULATOR

AZ1117

Typical Performance Characteristics (Continued)

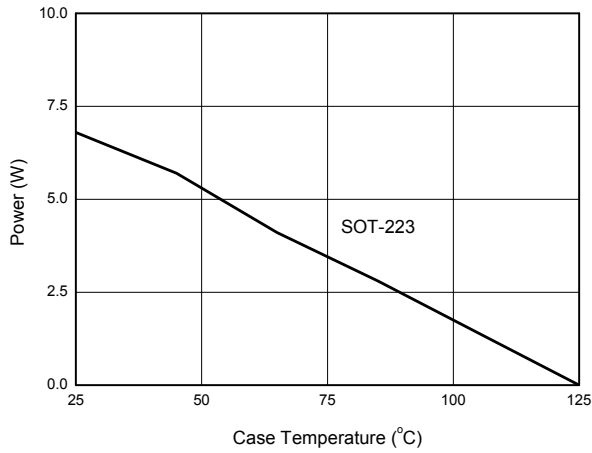

Figure 12. Maximum Power Dissipation

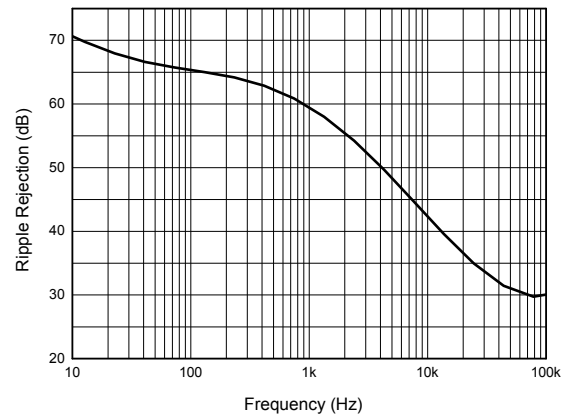

Figure 13. Ripple Rejection vs. Frequency

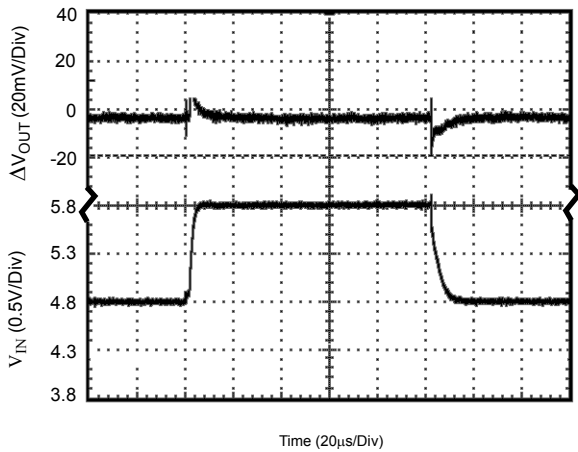

Figure 14. Line Transient Response
(Conditions: $V_{IN}=4.8$ to $5.8V$, $V_{OUT}=3.33V$,
 $I_{OUT}=0.1A$, $C_{IN}=1\mu F$, $C_{OUT}=10\mu F$)

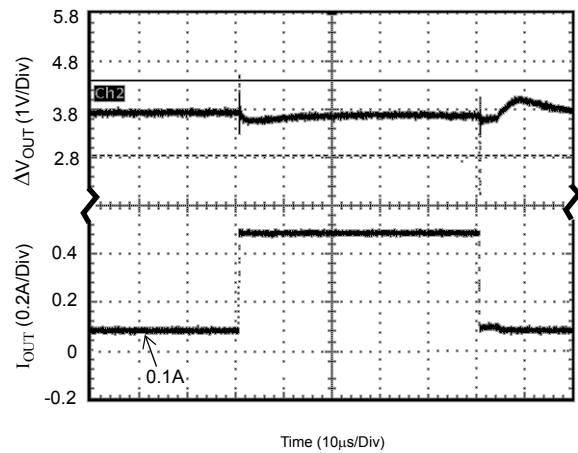

Figure 15. Load Transient Response
(Conditions: $V_{IN}=4.8V$, $V_{OUT}=3.33V$,
 $I_{OUT}=0.1$ to $0.5A$, $C_{IN}=C_{OUT}=10\mu F$)

1A LOW DROPOUT LINEAR REGULATOR

AZ1117

Typical Applications

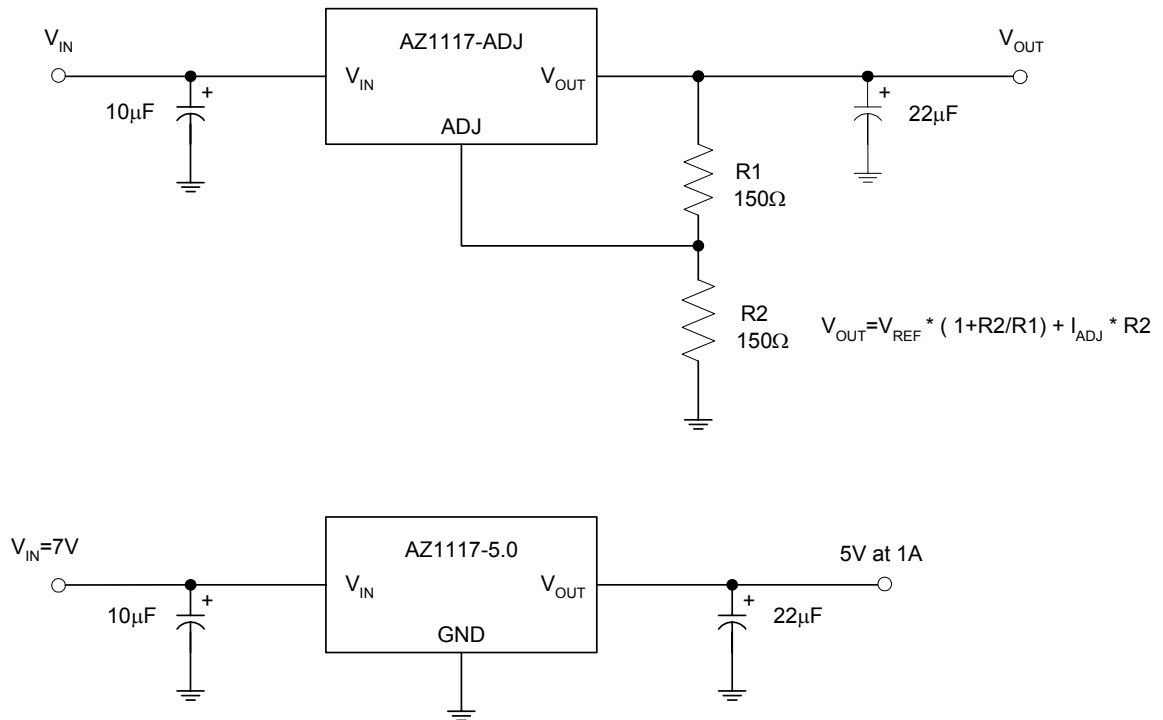

Figure 16. Typical Applications of AZ1117



1A LOW DROPOUT LINEAR REGULATOR

AZ1117

Mechanical Dimensions

SOT-223

Unit: mm(inch)

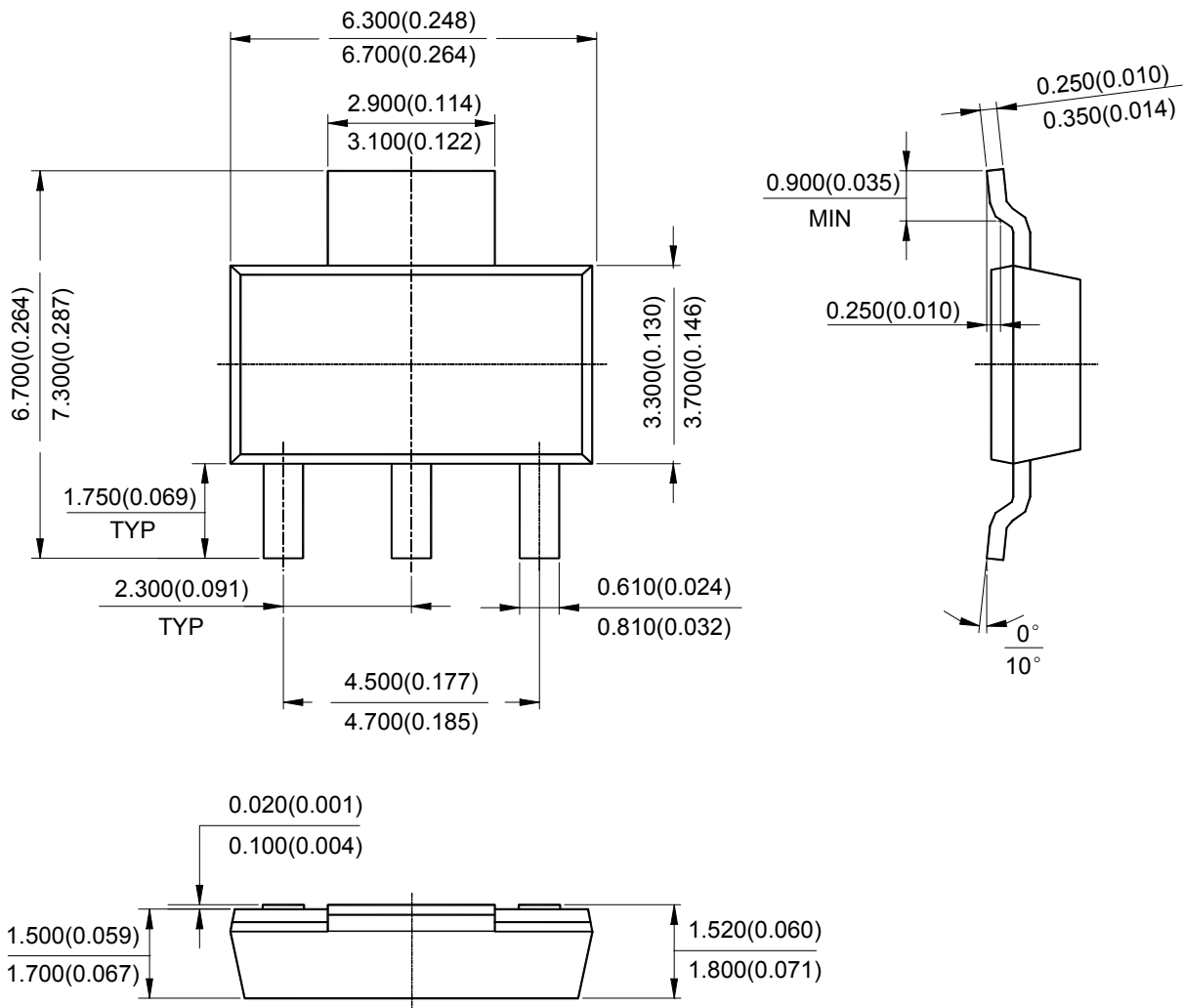



1A LOW DROPOUT LINEAR REGULATOR

AZ1117

Mechanical Dimensions (Continued)

TO-252-2 (1)

Unit: mm(inch)

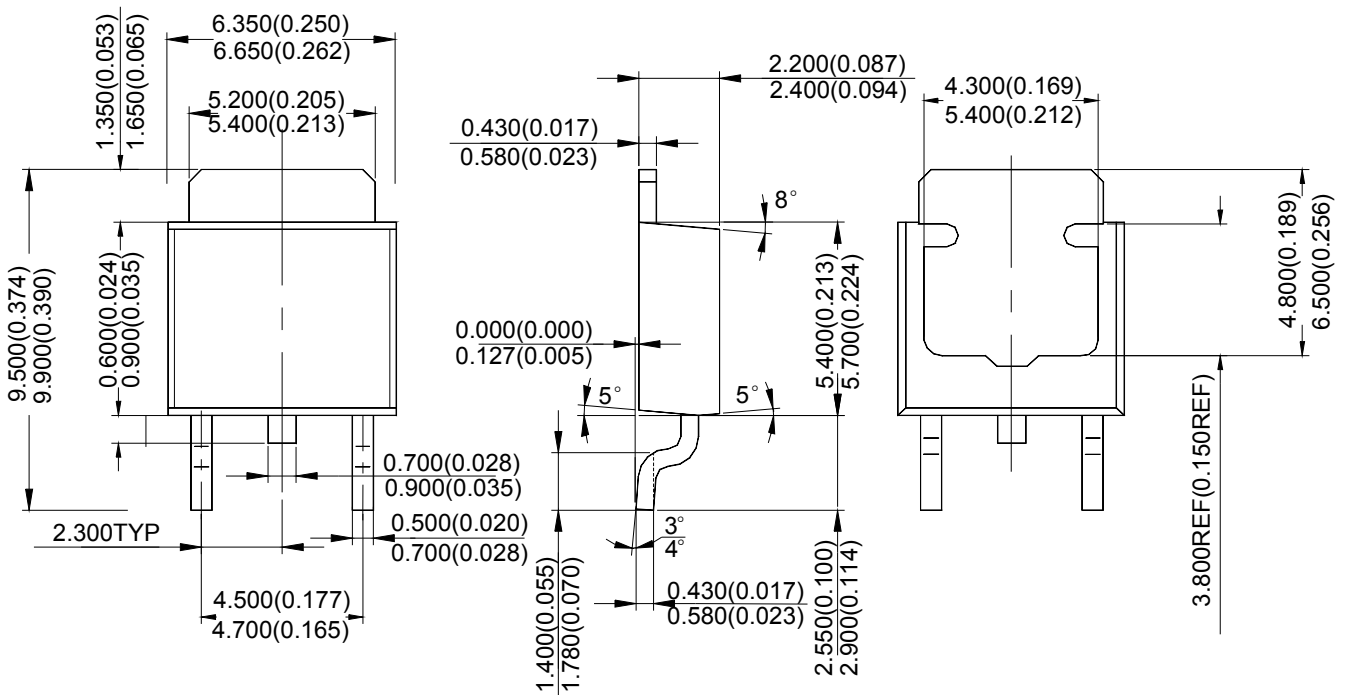



1A LOW DROPOUT LINEAR REGULATOR

AZ1117

Mechanical Dimensions (Continued)

TO-220-3

Unit: mm(inch)

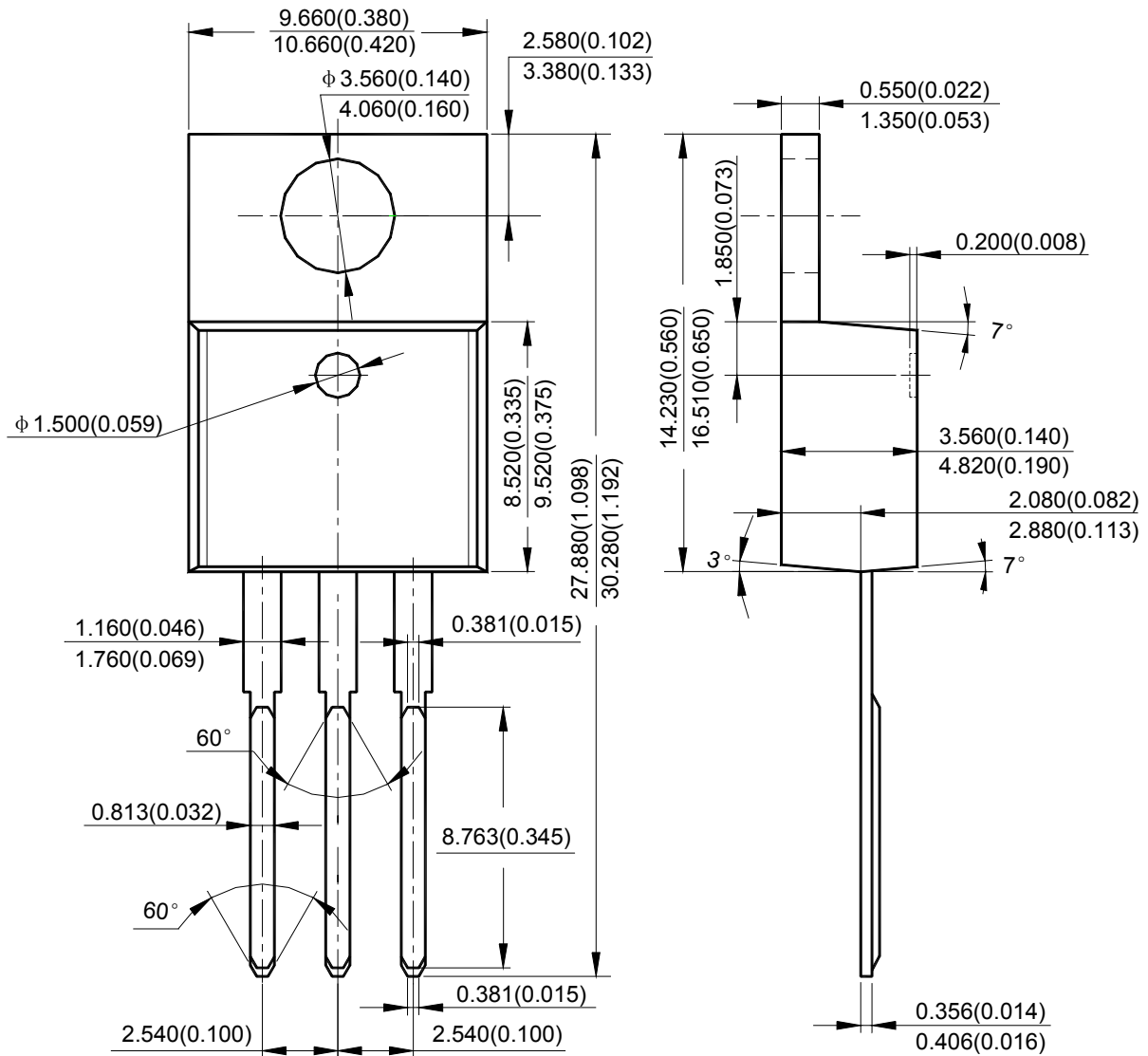



1A LOW DROPOUT LINEAR REGULATOR

AZ1117

Mechanical Dimensions (Continued)

TO-263-3

Unit: mm(inch)

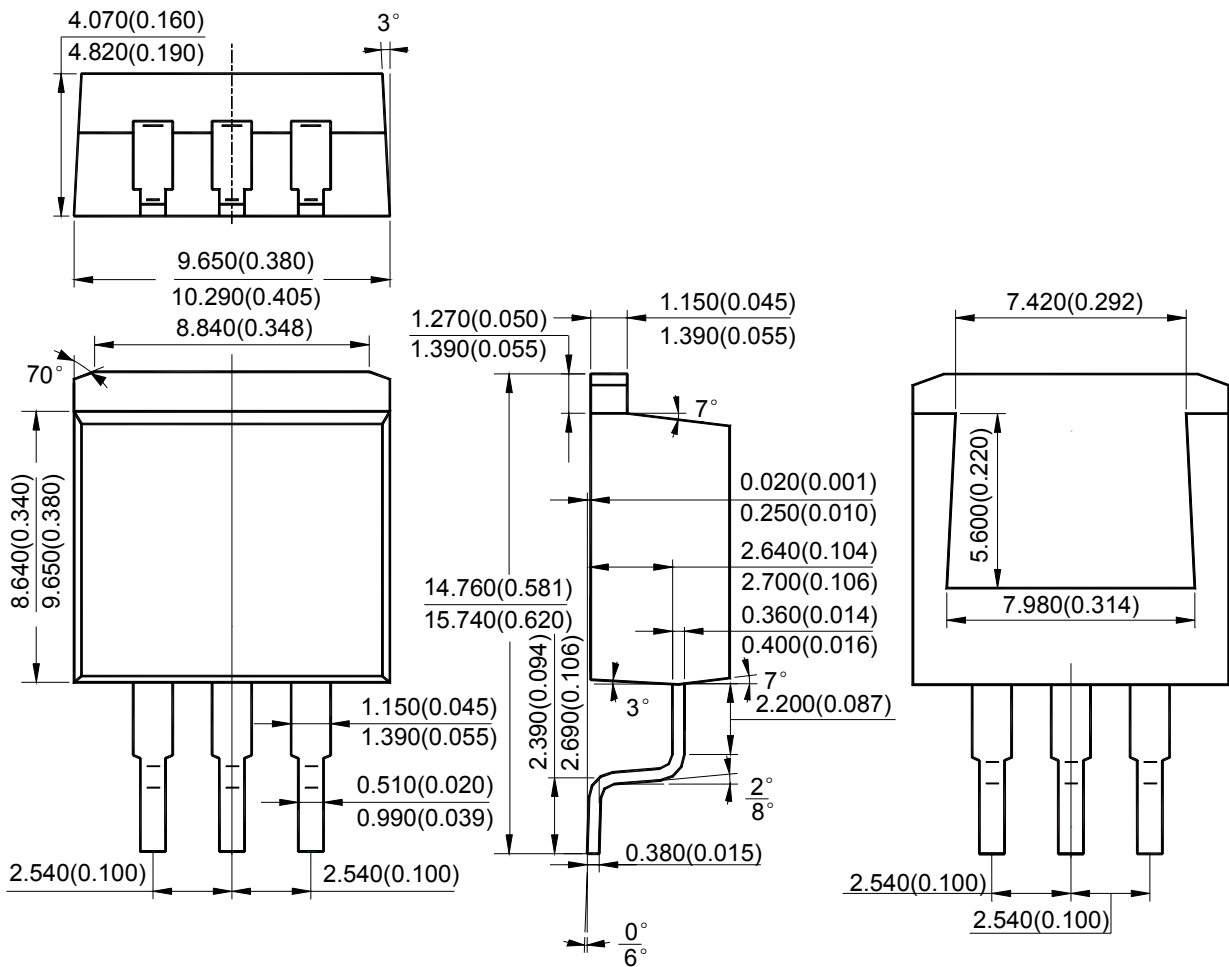



BCD Semiconductor Manufacturing Limited

<http://www.bcdsemi.com>

IMPORTANT NOTICE

BCD Semiconductor Manufacturing Limited reserves the right to make changes without further notice to any products or specifications herein. BCD Semiconductor Manufacturing Limited does not assume any responsibility for use of any its products for any particular purpose, nor does BCD Semiconductor Manufacturing Limited assume any liability arising out of the application or use of any its products or circuits. BCD Semiconductor Manufacturing Limited does not convey any license under its patent rights or other rights nor the rights of others.

MAIN SITE

- Headquarters

BCD Semiconductor Manufacturing Limited

No. 1600, Zi Xing Road, Shanghai Zizhu Science-based Industrial Park, 200241, China
Tel: +86-21-24162266, Fax: +86-21-24162277

- Wafer Fab

Shanghai SIM-BCD Semiconductor Manufacturing Co., Ltd.

800 Yi Shan Road, Shanghai 200233, China
Tel: +86-21-6485 1491, Fax: +86-21-5450 0008

REGIONAL SALES OFFICE

Shenzhen Office

Shanghai SIM-BCD Semiconductor Manufacturing Co., Ltd., Shenzhen Office
Room E, 5F, Noble Center, No.1006, 3rd Fuzhong Road, Futian District, Shenzhen,
518026, China
Tel: +86-755-8826 7951
Fax: +86-755-8826 7865

Taiwan Office



BCD Semiconductor (Taiwan) Company Limited
4F, 298-1, Rui Guang Road, Nei-Hu District, Taipei,
Taiwan
Tel: +886-2-2656 2808
Fax: +886-2-2656 2806

USA Office

BCD Semiconductor Corp.
30920 Huntwood Ave. Hayward,
CA 94544, USA
Tel : +1-510-324-2988
Fax: +1-510-324-2788

Looking for pricing, stock, or lifecycle information?

Click below to explore more details on WIN SOURCE:

-  [View AZ1117H-1.2TRG1 on WIN SOURCE](#)
-  [Diodes Incorporated Information](#)

Optimize Your Supply Chain with WIN SOURCE Solutions

-  Global Sourcing Solution
-  Obsolete Management
-  Cost Control Management
-  Shortage Management
-  Alternative Solution
-  Excess Inventory Management