



**THE DATASHEET OF
ZY1207HG-T3**





Applications

- Low voltage, high density systems with Intermediate Bus Architectures (IBA)
- Point-of-load regulators for high performance DSP, FPGA, ASIC, and microprocessor applications
- Desktops, servers, and portable computing
- Broadband, networking, optical, and communications systems
- Active memory bus terminators

Benefits

- Integrates digital power conversion with intelligent power management
- Eliminates the need for external power management components and communication bus
- Completely programmable via pin strapping and external R and C
- One part that covers all applications
- Reduces board space, system cost and complexity, and time to market

Description

Power-One's point-of-load converters are recommended for use with regulated bus converters in an Intermediate Bus Architecture (IBA). The ZY1207 is an intelligent, fully programmable step-down point-of-load DC-DC module integrating digital power conversion and intelligent power management. The ZY1207 completely eliminates the need for external components for sequencing, tracking, protection, monitoring, and reporting. Performance parameters of the ZY1207 are programmable by pin strapping and external resistor and capacitor and can be changed by a user at any time during product development and service without a need for a communication bus.

Features

- RoHS lead free and lead-solder-exempt products are available
- Wide input voltage range: 3V–14V
- High continuous output current: 7A
- Wide programmable output voltage range: 0.5V–5.5V
- Active digital current share
- Output voltage margining
- Overcurrent and overtemperature protections
- Overvoltage and undervoltage protections, and Power Good signal tracking the output voltage setpoint
- Programmable power-up delay
- Tracking during turn-on and turn-off with guaranteed slew rates
- Sequenced and cascaded modes of operation
- Single-wire line for frequency synchronization between multiple POLs
- Programmable interleave
- Programmable feedback loop compensation
- Enable control with programmable polarity
- Flexible fault management and propagation
- Start-up into the load pre-biased up to 100%
- Full rated current sink
- Real time current and temperature measurements, monitoring, and reporting
- Small footprint SMT package: 12.5x22mm
- Low profile of 6.5mm
- Compatible with conventional pick-and-place equipment
- Wide industrial operating temperature range
- UL 60950-1/CSA 22.2 No. 60950-1-07 Second Edition, IEC 60950-1: 2005, and EN 60950-1:2006

Reference Documents

No-Bus™ POL Converters. Z-1000 Series Application Note
Z-One® POL Converters. Eutectic Solder Process Application Note
Z-One® POL Converters. Lead-Free Process Application Note

1. Ordering Information

ZY	12	07	x	y	-	zz
Product family: Z-One Module	Series: No-Bus POL Converter	Output Current: 7A	Output voltage setpoint accuracy: No suffix – 1.5% or 35mV, whichever is greater. H¹ – 1.5% or 20mV, whichever is greater	RoHS compliance: No suffix - RoHS compliant with Pb solder exemption ² G - RoHS compliant for all six substances	Dash	Packaging Option³: T1 – 500pcs T&R T2 – 100pcs T&R T3 – 50pcs T&R Q1 – 1pc sample for evaluation only K1 – 1pc mounted on the evaluation board ⁴

¹ Contact factory for availability.

² The solder exemption refers to all the restricted materials except lead in solder. These materials are Cadmium (Cd), Hexavalent chromium (Cr6+), Mercury (Hg), Polybrominated biphenyls (PBB), Polybrominated diphenylethers (PBDE), and Lead (Pb) used anywhere except in solder.

³ Packaging option is used only for ordering and not included in the part number printed on the POL converter label.

⁴ The evaluation board is available in only one configuration: ZY1207-K1.

Example: **ZY1207HG-T2**: A 100-peices reel of RoHS compliant POL converters with the output voltage setpoint of 1.5% or 20mV, whichever is greater. Each POL converter is labeled ZY1207HG.

2. Absolute Maximum Ratings

Stresses in excess of the absolute maximum ratings may cause performance degradation, adversely affect long-term reliability, and cause permanent damage to the POL converter.

Parameter	Conditions/Description	Min	Max	Units
Operating Temperature	Controller Case Temperature	-40	105	°C
Input Voltage	250ms Transient		15	VDC
Output Current	(See Output Current Derating Curves)	-7	7	ADC

3. Environmental and Mechanical Specifications

Parameter	Conditions/Description	Min	Nom	Max	Units
Ambient Temperature Range		-40		85	°C
Storage Temperature (Ts)		-55		125	°C
Weight				8	grams
MTBF	Calculated Per Telcordia Technologies SR-332	6.24			MHrs
Peak Reflow Temperature	ZY1207 ZY1207G		245	220 260	°C °C
Lead Plating	ZY1207 and ZY1207G	100% Matte Tin or 1.5µm Ag over 1.5µm Ni			
Moisture Sensitivity Level	ZY1207 ZY1207G	2 3			

4. Electrical Specifications

Specifications apply at the input voltage from 3V to 14V, output load from 0 to 7A, ambient temperature from -40°C to 85°C, output capacitance consisting of 110µF ceramic and 220µF tantalum, and default performance parameters settings unless otherwise noted.

4.1 Input Specifications

Parameter	Conditions/Description	Min	Nom	Max	Units
Input voltage (V_{IN})	At $V_{IN}<4.75V$, VLDO pin needs to be connected to an external voltage source higher than 4.75V	3		14	VDC
Input Current (at no load)	$V_{IN}\geq 4.75V$, VLDO pin connected to VIN		50		mADC
Undervoltage Lockout (VLDO connected to VIN)	Ramping Up		4.00		VDC
	Ramping Down		3.9		VDC
Undervoltage Lockout (VLDO connected to $V_{AUX}=5V$)	Ramping Up		2.8		VDC
	Ramping Down		2.7		VDC
External Low Voltage Supply	Connect to VLDO pin when $V_{IN}<4.75V$	4.75		14	VDC
VLDO Input Current	Current drawn from the external low voltage supply at VLDO=5V		50		mADC

4.2 Output Specifications

Parameter	Conditions/Description	Min	Nom	Max	Units
Output Current (I_{OUT})	$V_{IN\ MIN}$ to $V_{IN\ MAX}$	-7 ¹		7	ADC
Output Voltage Range (V_{OUT})	Programmable ² with a resistor between TRIM and REF pins Default (no resistor)	0.5		5.5	VDC
			0.5		VDC
Output Voltage Setpoint Accuracy ³	$V_{IN}=12V$, $I_{OUT}=0.5*I_{OUT\ MAX}$, room temperature	See Ordering Information			
Line Regulation ³	$V_{IN\ MIN}$ to $V_{IN\ MAX}$		±0.2		% V_{OUT}
Load Regulation ³	0 to $I_{OUT\ MAX}$		±0.2		% V_{OUT}
Dynamic Regulation Peak Deviation Peak Deviation Settling Time	Slew rate 1A/µs, 50-75% load step, $V_{IN}\geq 5V$ $V_{IN}=3.3V$ to 10% of peak deviation		75		mV
			100		mV
			30		µs
Output Voltage Peak-to-Peak Ripple and Noise Full Load	$V_{IN}=5.0V$, $V_{OUT}\leq 2.5V$ $V_{IN}=5.0V$, $V_{OUT}>2.5V$ $V_{IN}=12V$, $V_{OUT}\leq 2.5V$ $V_{IN}=12V$, $V_{OUT}>2.5V$		15		mV
			25		mV
			25		mV
			40		mV
Temperature Coefficient	$V_{IN}=12V$, $I_{OUT}=0.5*I_{OUT\ MAX}$		50		ppm/°C
Switching Frequency		450	500	550	kHz

¹ At the negative output current (bus terminator mode) efficiency of the ZY1207 degrades resulting in increased internal power dissipation. Therefore maximum allowable negative current under specific conditions is 20% lower than the current determined from the derating curves shown in paragraph 5.5.

² ZY1207 is a step-down converter, thus the output voltage is always lower than the input voltage as show in Figure 1.

³ Digital PWM has an inherent quantization uncertainty of ±6.25mV that is not included in the specified static regulation parameters.

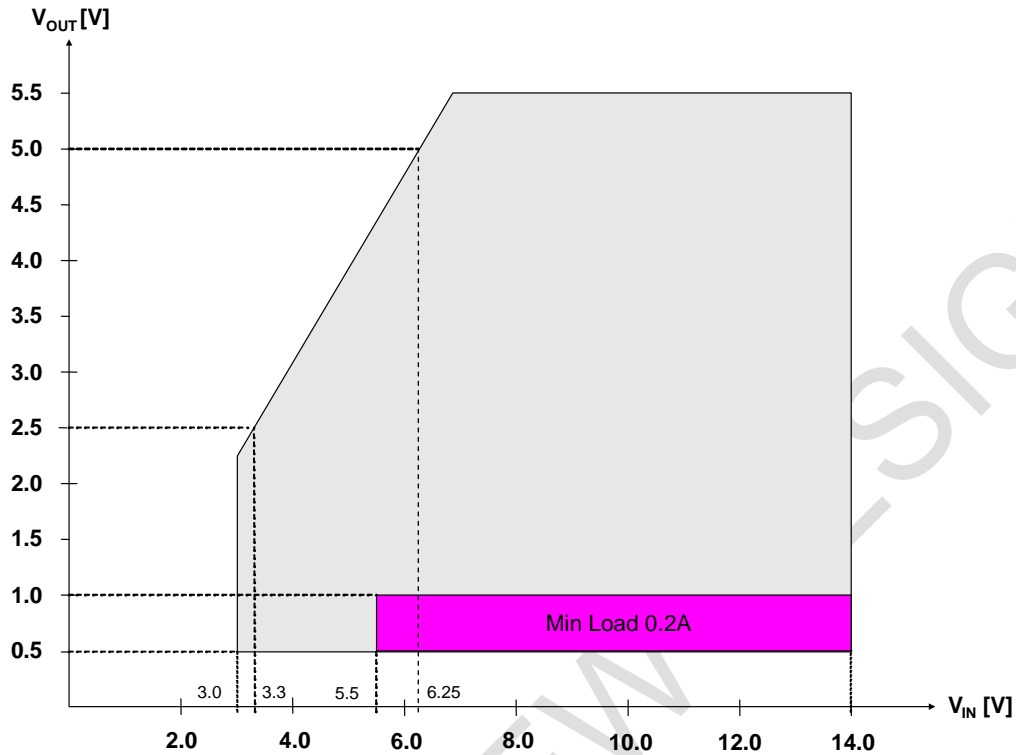

Figure 1. Output Voltage as a Function of Input Voltage and Output Current

4.3 Protection Specifications

Parameter	Conditions/Description	Min	Nom	Max	Units
Output Overcurrent Protection					
Type		Non-Latching, 130ms period			
Threshold			140		%I _{OUT}
Threshold Accuracy		-25		25	%I _{OCP.SET}
Output Overvoltage Protection					
Type		Latching			
Threshold	Follows the output voltage setpoint		130 ¹		%V _{O.SET}
Threshold Accuracy	Measured at V _{O.SET} =2.5V	-2		2	%V _{OVP.SET}
Delay	From instant when threshold is exceeded until the turn-off command is generated		6		μs
Output Undervoltage Protection					
Type		Non-Latching, 130ms period			
Threshold	Follows the output voltage setpoint		75		%V _{O.SET}
Threshold Accuracy	Measured at V _{O.SET} =2.5V	-2		2	%V _{UVP.SET}
Delay	From instant when threshold is exceeded until the turn-off command is generated		6		μs

Overtemperature Protection					
Type		Non-Latching, 130ms period			
Turn Off Threshold	Temperature is increasing		120		°C
Turn On Threshold	Temperature is decreasing after module was shut down by OTP		110		°C
Threshold Accuracy		-5		5	°C
Delay	From instant when threshold is exceeded until the turn-off command is generated		6		µs
Power Good Signal (PGOOD pin)					
Logic	V _{OUT} is inside the PG window and stable V _{OUT} is outside of the PG window or ramping up/down		High Low		N/A
Lower Threshold	Follows the output voltage setpoint		90		%V _{O,SET}
Upper Threshold	Follows the output voltage setpoint		110		%V _{O,SET}
Delay	From instant when threshold is exceeded until status of PG signal changes		6		µs
Threshold Accuracy	Measured at V _{O,SET} =2.5V	-2		2	%V _{O,SET}

¹ Minimum OVP threshold is 1.0V

4.4 Feature Specifications

Parameter	Conditions/Description	Min	Nom	Max	Units
Current Share (CS pin)					
Type		Active, Single Line			
Maximum Number of Modules Connected in Parallel	I _{OUT MIN} =0	4			
Current Share Accuracy	I _{OUT MIN} ≥20%*I _{OUT NOM}			±20	%I _{OUT}
Interleave (IM and INTL2...INTL4 pins)					
Interleave (Phase Lag)	Programmable via INTL2...INTL4 pins in 45° steps	0		315	degree
Sequencing (DELAY pin)					
Power-Up Delay	Programmable by capacitor connected to DELAY pin			210	ms
	Default: C _{DELAY} =0		0		ms
Tracking					
Rising Slew Rate	Proportional to SYNC frequency		0.1		V/ms
Falling Slew Rate	Proportional to SYNC frequency		-0.5		V/ms

Enable (EN and ENP pins)					
EN Pin Polarity	ENP pin is pulled low	Negative (enables the output when EN pin is pulled low)			
	ENP pin is open	Positive (enables the output when EN pin is open or pulled high)			
EN High Threshold		2.3			VDC
EN Low Threshold				1.0	VDC
Open Circuit Voltage	EN and ENP		3.3		VDC
Turn-On Delay	From EN pin changing state to V _{OUT} starting to ramp up		0		ms
Turn-Off Delay	From EN pin changing state to V _{OUT} reaching 0V		11		ms
Feedback Loop Compensation (CCA0...CCA2 pins)					
CCA=7 (default)	Recommended V _{IN} range	8	12	14	VDC
	Recommended C _{OUT} /ESR range, combination of ceramic+ tantalum	50/5 + 220/40	100/5 + 470/40	400/5 + 2000/20	μF/mΩ μF/mΩ
CCA=6	Recommended V _{IN} range	8	12	14	VDC
	Recommended C _{OUT} range, tantalum Recommended ESR range, tantalum	440 40	880 25	10,000 10	μF mΩ
CCA=5	Recommended V _{IN} range	8	12	14	VDC
	Recommended C _{OUT} /ESR range, ceramic	100/5	220/5	400/5	μF/mΩ
CCA=3 or CCA=4	Recommended V _{IN} range	3	5	5.5	VDC
	Recommended C _{OUT} /ESR range, combination of ceramic + tantalum	50/5 + 220/40	100/5 + 470/40	200/5 + 880/40	μF/mΩ μF/mΩ
CCA=2	Recommended V _{IN} range	3	5	5.5	VDC
	Recommended C _{OUT} /ESR range, tantalum	100/25	440/20	1,000/10	μF/mΩ
CCA=1	Recommended V _{IN} range	3	5	5.5	VDC
	Recommended C _{OUT} /ESR range, ceramic	100/5	220/5	400/5	μF/mΩ
CCA=0	Recommended V _{IN} range	6		11	VDC
	Recommended C _{OUT} /ESR range, combination of ceramic+ tantalum	50/5 + 220/40	100/5 + 470/40	200/5 + 880/40	μF/mΩ μF/mΩ
Output Current Monitoring (CS pin)					
Output Current Monitoring Accuracy	20%*I _{OUT NOM} < I _{OUT} < I _{OUT NOM} V _{IN} =12V	-20		+20	%I _{OUT}
Conversion Ratio	Duty Cycle of the negative pulse corresponding to 100% of nominal current		70		%
Temperature Monitoring (TEMP pin)					
Temperature Monitoring Accuracy	Junction temperature of POL controller	-5		+5	°C
Conversion Ratio	Junction temperature from -40°C to 140°C		10		mV/°C
Monitoring Voltage Range	Corresponds to -40°C to 140°C junction temperature range	0.2		2	VDC
Output Impedance	TEMP pin		6.4		kΩ
Remote Voltage Sense (+VS pin)					
Voltage Drop Compensation	Between +VS and V _{OUT}			300	mV

4.5 Signal Specifications

Parameter	Conditions/Description	Min	Nom	Max	Units
VDD	Internal supply voltage	3.15	3.3	3.45	V
SYNC Line					
ViL_s	LOW level input voltage	-0.5		0.3 x VDD	V
ViH_s	HIGH level input voltage	0.75 x VDD		VDD + 0.5	V
Vhyst_s	Hysteresis of input Schmitt trigger	0.25 x VDD		0.45 x VDD	V
IoL_s	LOW level sink current V(SYNC)=0.5V	14		60	mA
Ipu_s	Pull-up current source V(SYNC)=0V	300		1000	µA
Tr_s	Maximum allowed rise time 10/90%VDD			300	ns
Cnode_s	Added node capacitance		5	10	pF
Freq_s	Clock frequency of external SYNC line	475		525	kHz
Tsynq	Sync pulse duration	22		28	% of clock cycle
T0	Data=0 pulse duration	72		78	% of clock cycle
Inputs: INTL2...INTL4, CCA0...CCA2, EN, ENP, IM					
Iup_x	Pull-up current source V(X)=0	25		110	µA
ViL_x	LOW level input voltage	-0.5		0.3 x VDD	V
ViH_x	HIGH level input voltage	0.7 x VDD		VDD+0.5	V
Vhyst_x	Hysteresis of input Schmitt trigger	0.1 x VDD		0.3 x VDD	V
RdnL_x	External pull down resistance pin forced low			10	kOhm
Power Good and OK Inputs/Outputs					
Iup_PG	Pull-up current source V(PG)=0	25		110	µA
Iup_OK	Pull-up current source V(OK)=0	175		725	µA
ViL_x	LOW level input voltage	-0.5		0.3 x VDD	V
ViH_x	HIGH level input voltage	0.7 x VDD		VDD+0.5	V
Vhyst_x	Hysteresis of input Schmitt trigger	0.1 x VDD		0.3 x VDD	V
IoL_x	LOW level sink current at 0.5V	4		20	mA
Current Share/Sense Bus					
Iup_CS	Pull-up current source at V(CS)=0V	0.84		3.10	mA
ViL_CS	LOW level input voltage	-0.5		0.3 x VDD	V
ViH_CS	HIGH level input voltage	0.75 x VDD		VDD+0.5	V
Vhyst_CS	Hysteresis of input Schmitt trigger	0.25 x VDD		0.45 x VDD	V
IoL_CS	LOW level sink current V(CS)=0.5V	14		60	mA
Tr_CS	Maximum allowed rise time 10/90% VDD			100	ns

5. Typical Performance Characteristics

5.1 Efficiency Curves

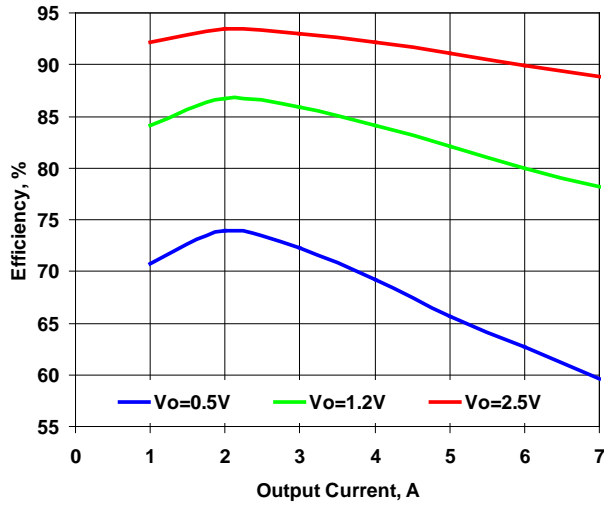

Figure 2. Efficiency vs. Load. Vin=3.3V

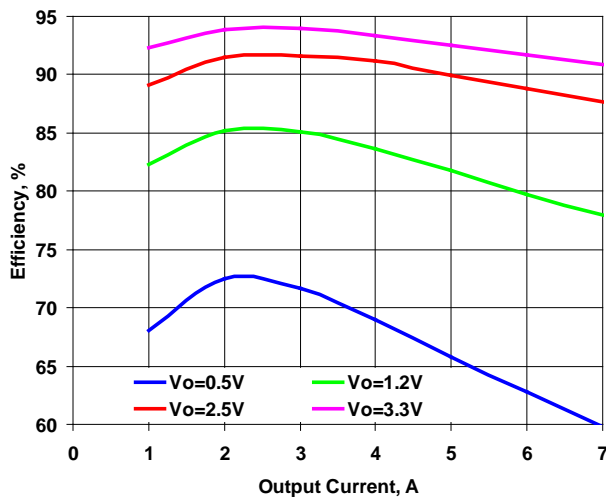

Figure 3. Efficiency vs. Load. Vin=5V

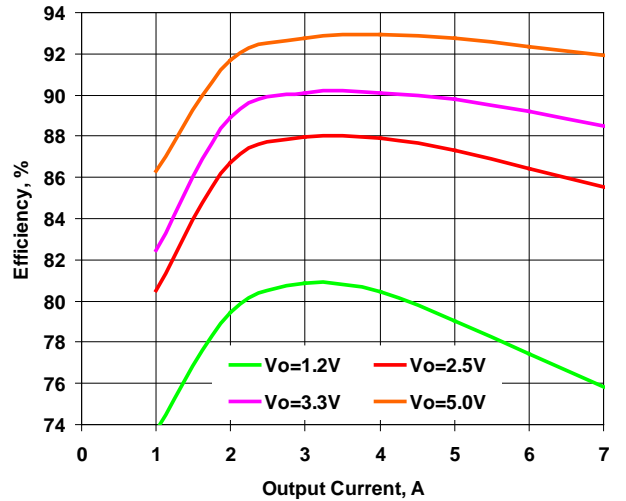

Figure 4. Efficiency vs. Load. Vin=9.6V

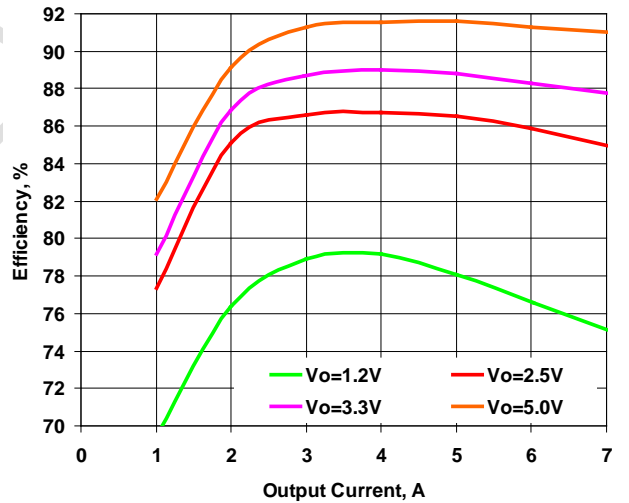

Figure 5. Efficiency vs. Load. Vin=12V

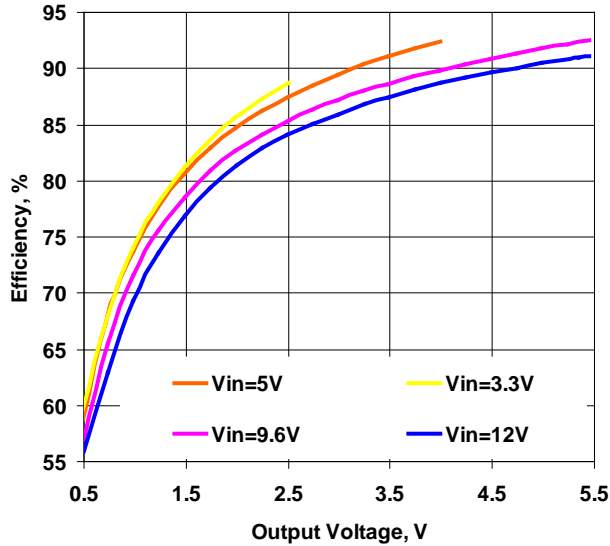

Figure 6. Efficiency vs. Output Voltage, Iout=7A

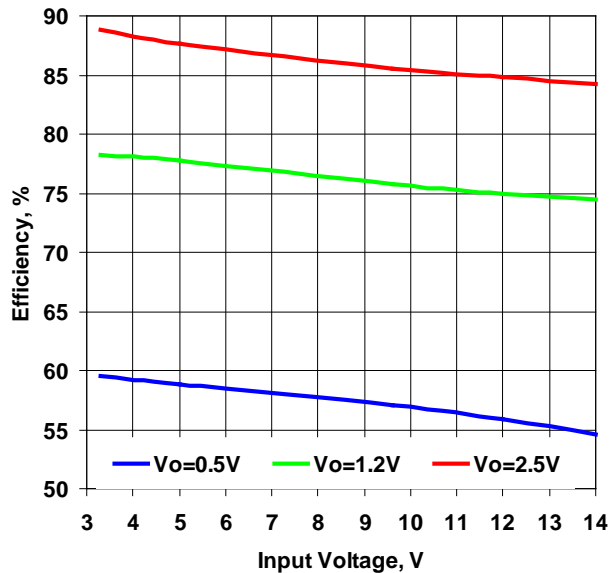

Figure 7. Efficiency vs. Input Voltage, Iout=7A

5.2 Turn-On Characteristics

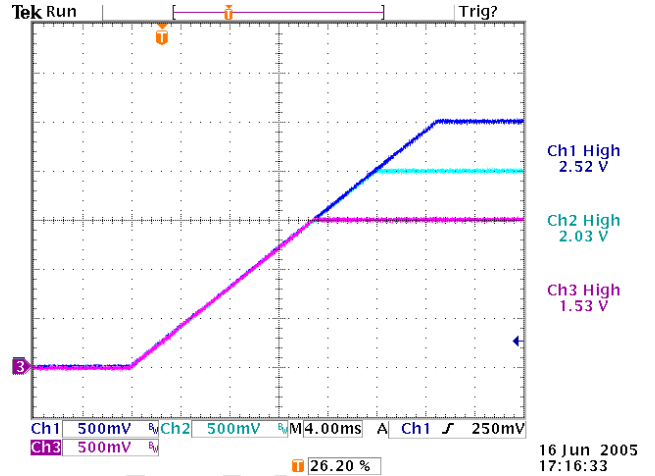

Figure 8. Tracking Turn-On.
Vin=12V, Ch1 – V1, Ch2 – V2, Ch3 – V3

5.3 Turn-Off Characteristics

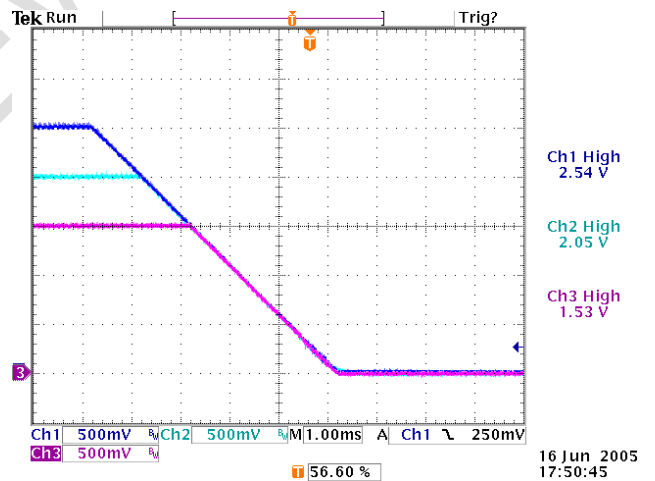

Figure 9. Tracking Turn-Off
Vin=12V, Ch1 – V1, Ch2 – V2, Ch3 – V3

5.4 Transient Response

The pictures in Figure 10 - Figure 15 show the deviation of the output voltage in response to the 50-75-50% step load at 1.0A/μs. In all tests the POL converters had 5x22μF ceramic capacitors and a 220μF tantalum capacitor connected across the output pins. The speed of the transient response was optimized by selecting appropriate CCA settings.

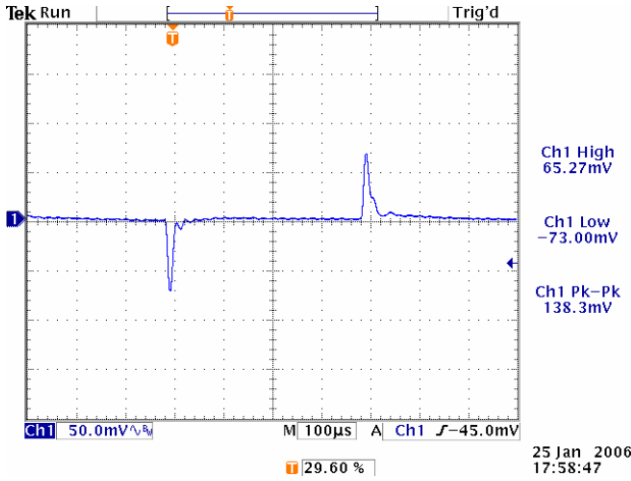

Figure 10. Vin=12V, Vout=1V. CCA=00

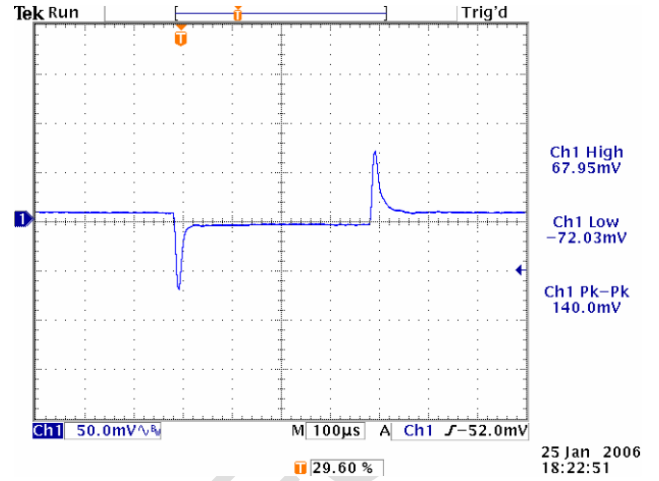

Figure 13. Vin=5V, Vout=1V. CCA=03

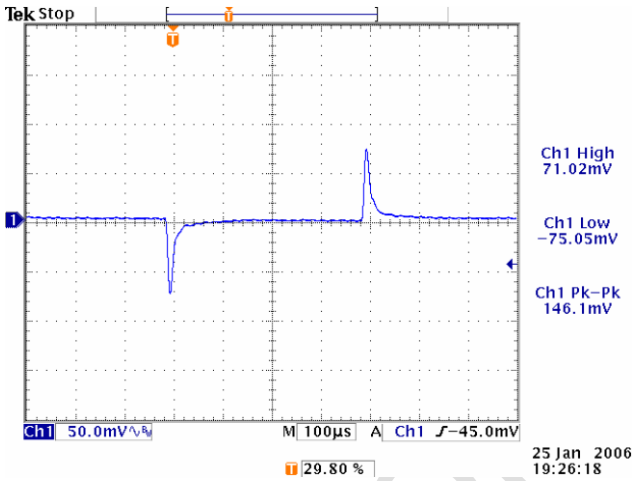

Figure 11. Vin=12V, Vout=2.5V. CCA=00

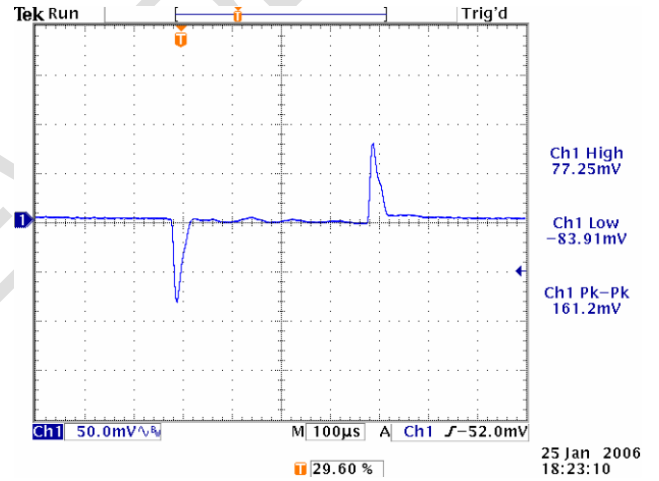

Figure 14. Vin=5V, Vout=2.5V. CCA=03

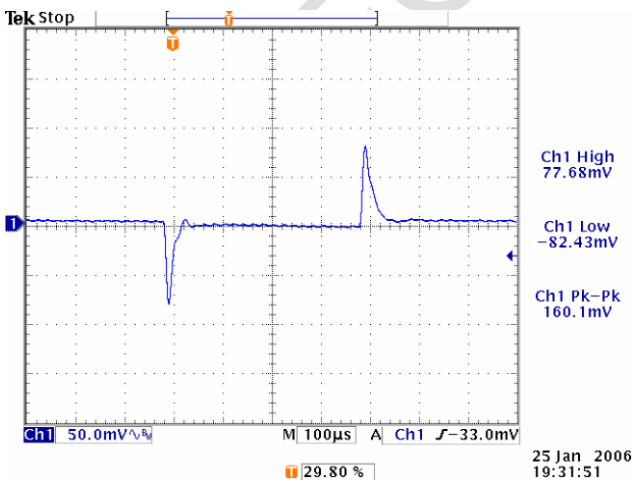

Figure 12. Vin=12V, Vout=5V, CCA=00

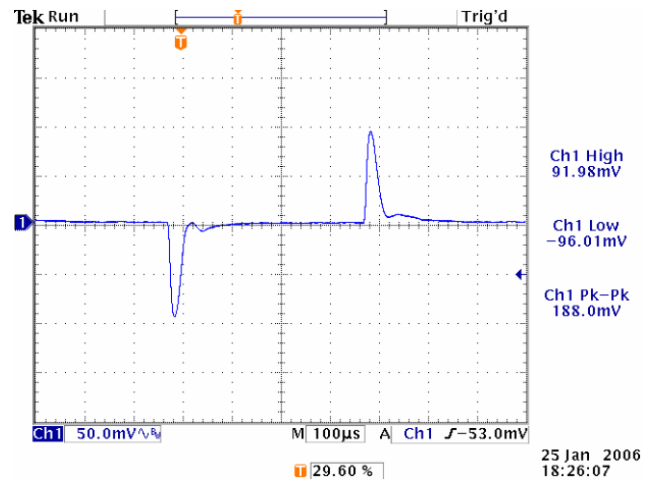

Figure 15. Vin=3.3V, Vout=1V. CCA=03

5.5 Thermal Derating Curves

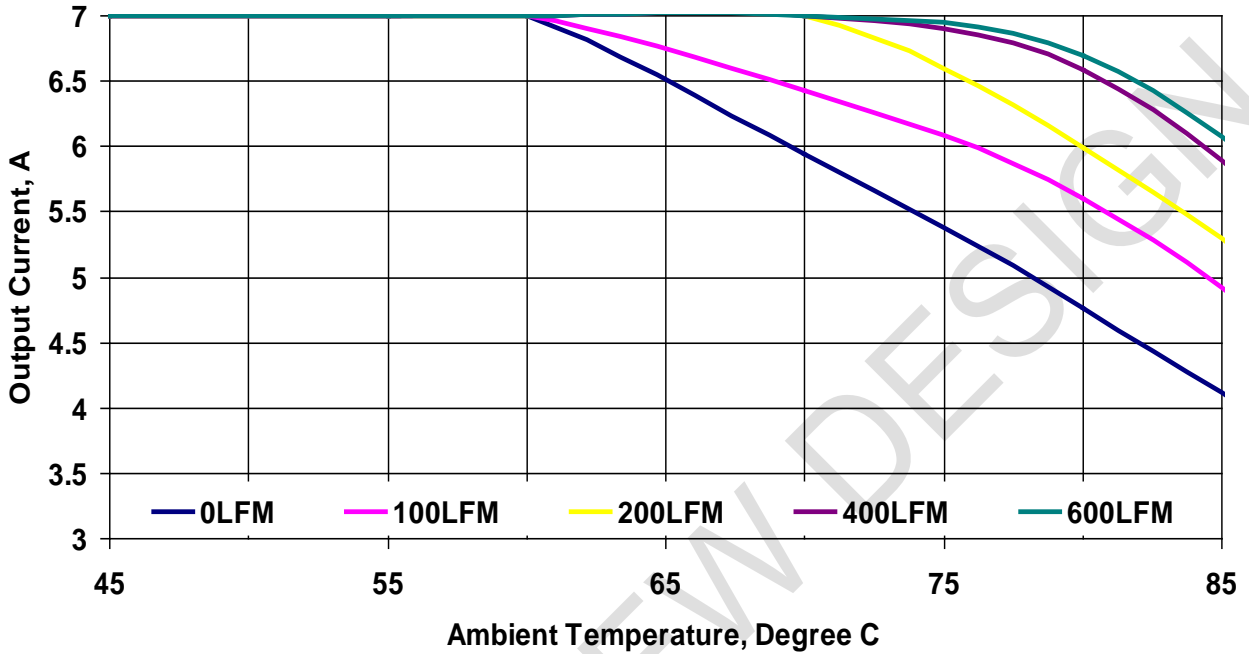

Figure 16. Thermal Derating Curves. Vin=12V, Vout=5.0V

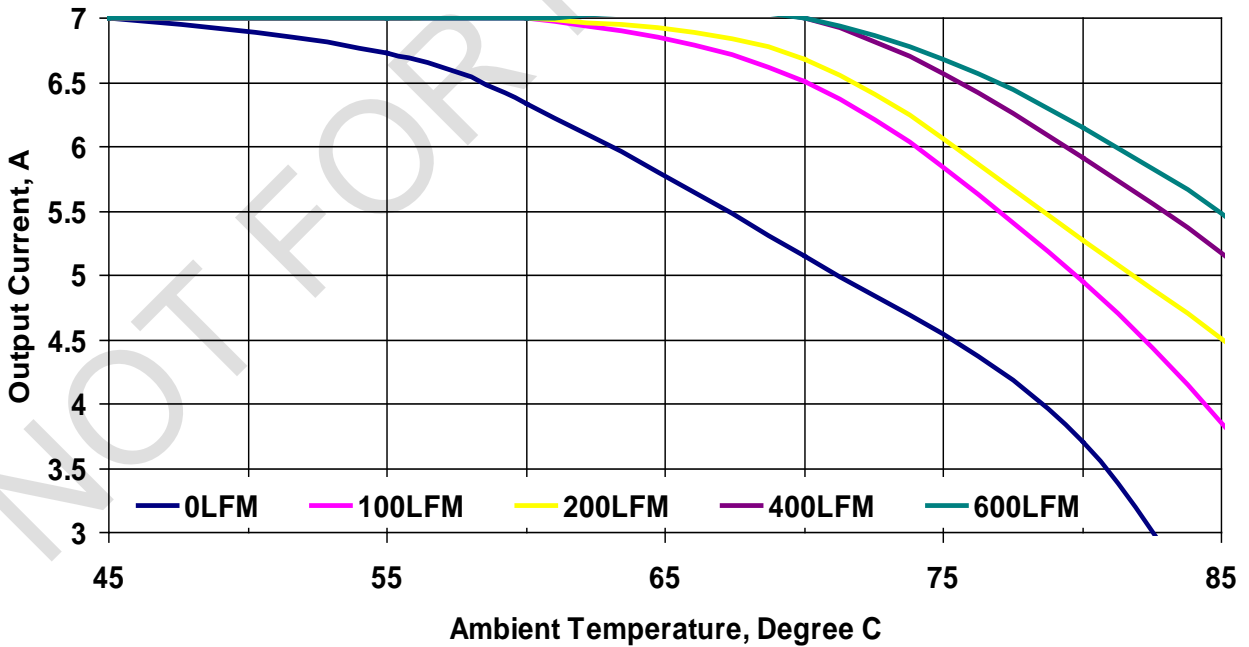

Figure 17. Thermal Derating Curves. Vin=14V, Vout=5.0V

6. Typical Application

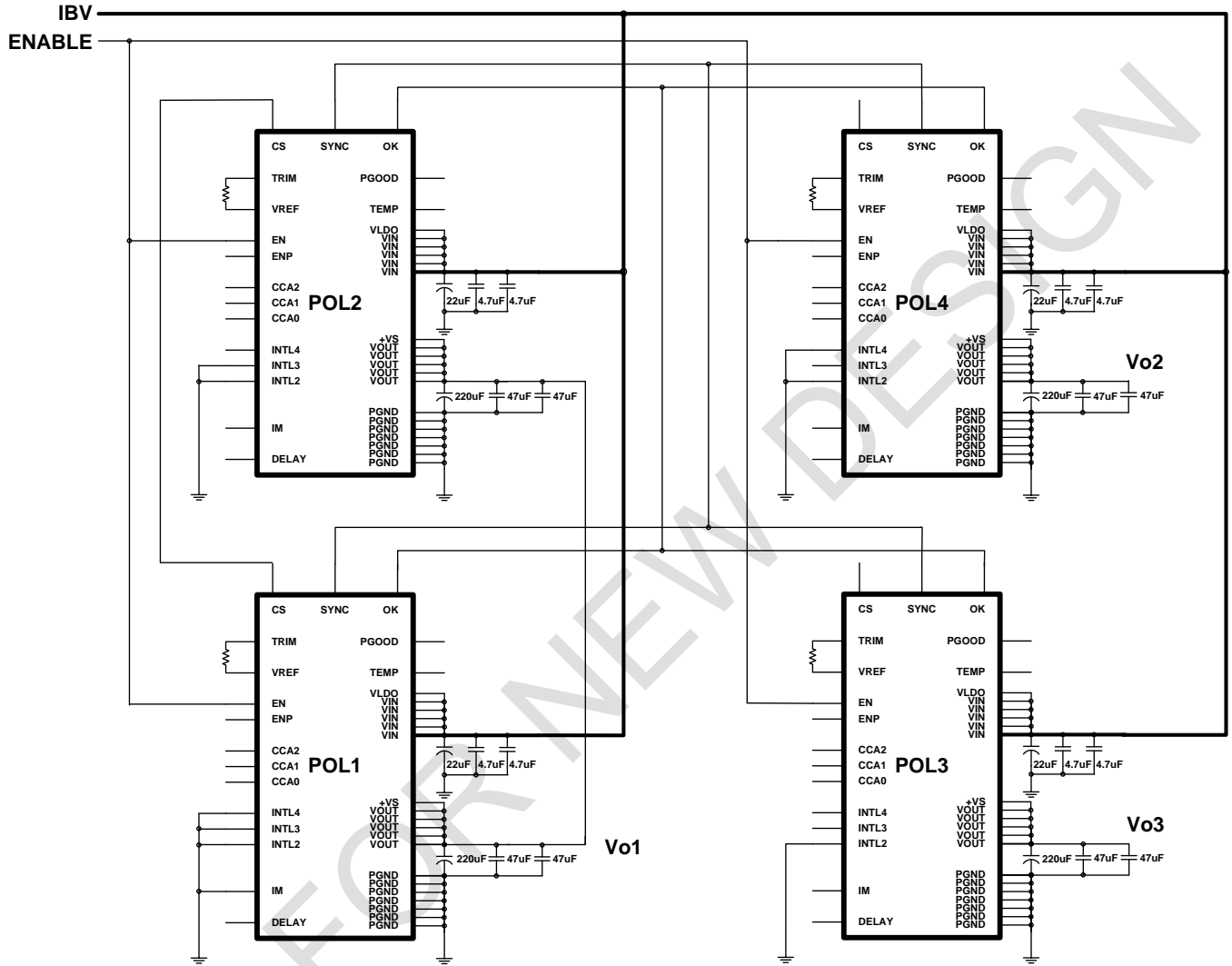

Figure 18. Complete Schematic of Application with Three Independent Outputs. Intermediate Bus Voltage is from 8V to 14V.

In this application four POL converters are configured to deliver three independent output voltages. POL1 and POL2 are connected in parallel for increased output current. Output voltages are programmed with the resistors connected between TRIM and VREF pins of individual converters.

POL1 is configured as a master (IM and INTL0...INTL4 pins are grounded) and all other POL converters are synchronized to the switching frequency of POL1. Interleave is programmed with pins INTL0...INTL4 to ensure the lowest input and output noise. POL2 has 180° phase shift, POL 3 and POL4 have phase shifts of 270° and 90° respectively.

All converters are controlled by the common ENABLE signal. Turn-on and turn-off processes of the system are illustrated by pictures in Figure 8 and Figure 9.

7. Pin Assignments and Description

Pin Name	Pin No.	Pin Type	Buffer Type	Pin Description	Notes
VLDO	1	P		Low Voltage Dropout	Connect to an external voltage source higher than 4.75V, if $V_{IN} < 4.75V$. Connect to V_{IN} , if $V_{IN} \geq 4.75V$
CCA0	2	I	PU	Compensation Coefficient Address Bit 0	Tie to PGND for 0 or leave open for 1
CCA1	3	I	PU	Compensation Coefficient Address Bit 1	Tie to PGND for 0 or leave open for 1
CCA2	4	I	PU	Compensation Coefficient Address Bit 2	Tie to PGND for 0 or leave open for 1
TEMP	5	A		Temperature Measurement	Analog voltage proportional to junction temperature of the controller
ENP	6	I	PU	Enable Logic Selection	Tie to PGND for Negative logic or leave open for Positive logic
INTL2	7	I	PU	Interleave Bit 2	Tie to PGND for 0 or leave open for 1
INTL3	8	I	PU	Interleave Bit 3	Tie to PGND for 0 or leave open for 1
INTL4	9	I	PU	Interleave Bit 4	Tie to PGND for 0 or leave open for 1
CS	10	I/O	PU	Current Share/Sense	Connect to CS pin of other Z-POLs connected in parallel
TRIM	11	A		Output Voltage Trim	To program the output voltage, connect a resistor between VREF and TRIM
PGOOD	12	I/O	PU	Power Good	
SYNC	13	I/O	PU	Frequency Synchronization Line	Connect to SYNC pin of other Z-POLs and/or to an external clock generator
OK	14	I/O	PU	Fault Status	Connect to OK pin of other Z-1000 POLs. Leave open, if not used
EN	15	I	PU	Enable	Polarity is determined by ENP pin
VREF	16	A		Voltage Reference	To program the output voltage, connect a resistor between VREF and TRIM
IM	17	I	PU	Interleave Mode	Tie to PGND for master or leave open to set interleave by INTL0...INTL4 pins
DELAY	18	A		Power-Up Delay	Connect a capacitor between the pin and PGND to program the Power-Up delay. Leave open for zero delay
VOUT	19-23	P		Output Voltage	
+VS	24	I	PU	Positive Voltage Sense	Connect to the positive point close to the load
PGND	25-31	P		Power Ground	
VIN	32-36	P		Input Voltage	

Legend: I=input, O=output, I/O=input/output, P=power, A=analog, PU=internal pull-up

8. Pin and Feature Description

8.1 VLDO, Low Voltage Dropout

The input of the internal linear regulator. V_{VLDO} always needs to be greater than 4.75V for normal operation of the POL converter.

8.2 IM, Interleave Mode

The input with the internal pull-up resistor. When the pin is left floating, the phase lag of the POL converter is set by INTL2...INTL4 pins. If the pin is pulled low, the phase lag is set to 0°. Pulling all INTL pins and the IM pin low configures a POL converter as a master. The master determines the clock on the SYNC line.

8.3 TEMP, Temperature Measurement

The voltage output of the internal temperature sensor measuring junction temperature of the controller IC. Voltage range from 0 to 2V corresponds to the temperature range from -50°C to 150°C.

8.4 ENP, Enable Polarity

The input with the internal pull-up resistor. When the ENP pin is pulled low, the control logic of the EN input is inverted.

8.5 DELAY, Power-Up Delay

The input of the POR circuit with the internal pull-up resistor. By connecting a capacitor between the pin and PGND the power-up delay can be programmed.

8.6 CCA[0:2], Compensation Coefficient Address

Inputs with internal pull-ups to select one of 7 sets of digital filter coefficients optimized for various application conditions.

8.7 VREF, Voltage Reference

The output of the 2V internal voltage reference that is used to program the output voltage of the POL converter.

8.8 EN, Enable

The input with the internal pull-up resistor. The POL converter is turned off, when the pin is pulled low (see ENP to inverse logic of the Enable function).

8.9 OK, Fault Status

The open drain input/output with the internal pull-up resistor. The POL converter pulls its OK pin low, if a

fault occurs. Pulling low the OK input by an external circuitry turns off the POL converter.

8.10 SYNC, Frequency Synchronization Line

The bidirectional input/output with the internal pull-up resistor. If the POL converter is configured as a master, the SYNC line propagates clock to other POL converters. If the POL converter is configured as a slave, the internal clock recovery circuit synchronizes the POL converter to the clock of the SYNC line.

8.11 PG, Power Good

The open drain input/output with the internal pull-up resistor. The pin is pulled low by the POL converter, if the output voltage is outside of the window defined by the Power Good High and Low thresholds.

Note: See the No-Bus Application Note for recommendations on PG deglitching.

8.12 TRIM, Output Voltage Trim

The input of the TRIM comparator for the output voltage programming.

The output voltage can be programmed by a single resistor connected between VREF and TRIM pins. Resistance of the trim resistor can be determined from the equation below:

$$R_{TRIM} = \frac{20 \times (5.5 - V_{OUT})}{V_{OUT}}, \text{ kOhms}$$

where V_{OUT} is the desired output voltage in Volts.

If the R_{TRIM} is open or the TRIM pin is shorted to PGND, the $V_{OUT}=0.5V$.

8.13 CS, Current Share/Sense Bus

The open drain digital input/output with the internal pull-up resistor. The duty cycle of the digital signal is proportional to the output current of the POL converter. External capacitive loading of the pin shall be avoided.

8.14 INTL[2:4], Interleave Bits

Inputs with internal pull-up resistors. The encoded number determines the phase lag of the POL converter when the IM pin is left floating. The phase lag is equal to the number multiplied by 45°.

8.15 +VS

The positive voltage input of the POL converter feedback loop.

9. Application Information

9.1 Output Voltage Margining

Margining can be implemented either by changing the trim voltage as described in the previous paragraph or by changing the resistance between the REF and TRIM pins.

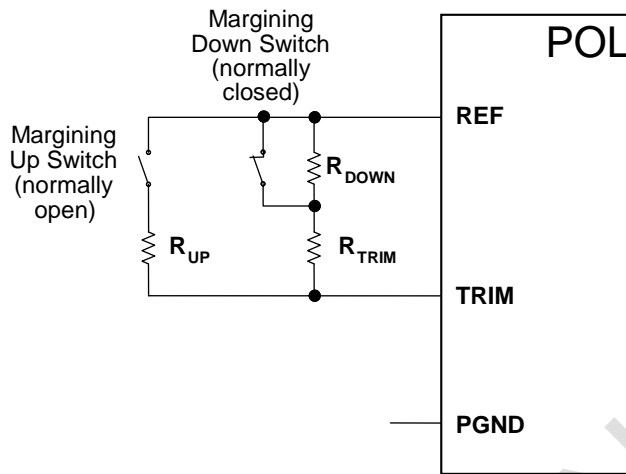

Figure 19. Margining Configuration

In the schematic shown in Figure 19, the nominal output voltage is set with the trim resistor R_{TRIM} calculated from the equation in the paragraph 8.12. Resistors R_{UP} and R_{DOWN} are added to margin the output voltage up and down respectively and determined from the equations below.

$$R_{UP} = \frac{20 \times R_{TRIM}}{20 + R_{TRIM}} \times \left(\frac{5 \times R_{TRIM} - \Delta V\%}{\Delta V\%} \right), \text{ k}\Omega$$

$$R_{DOWN} = (20 + R_{TRIM}) \times \left(\frac{\Delta V\%}{100 - \Delta V\%} \right), \text{ k}\Omega$$

where R_{TRIM} is the value of the trim resistor in $\text{k}\Omega$ and $\Delta V\%$ is the absolute value of desired margining expressed in percents of the nominal output voltage.

During normal operation the resistors are removed from the circuit by the switches. The “Margining Down” switch is normally closed shorting the resistor R_{DOWN} while the “Margining Up” switch is normally open disconnecting the resistor R_{UP} .

An alternative configuration of the margining circuit is shown in Figure 20. In this configuration both switches are normally open that may be advantageous in some implementations.

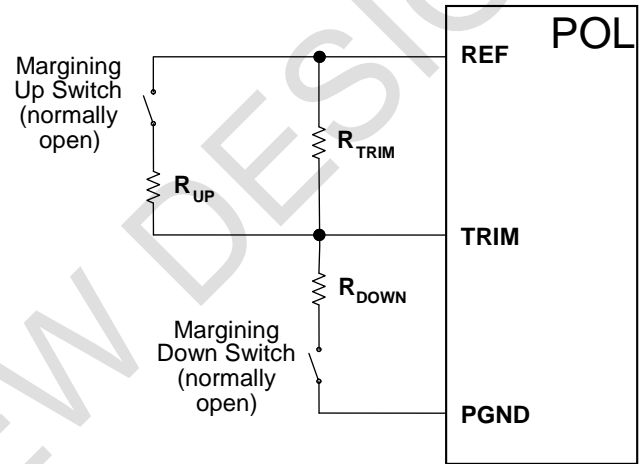

Figure 20. Alternative Margining Configuration

R_{UP} and R_{DOWN} for this configuration are determined from the following equations:

$$R_{UP} = \frac{20 \times R_{TRIM}}{20 + R_{TRIM}} \times \left(\frac{5 \times R_{TRIM} - \Delta V\%}{\Delta V\%} \right), \text{ k}\Omega$$

$$R_{DOWN} = \frac{20 \times R_{TRIM}}{20 + R_{TRIM}} \times \left(\frac{100 - \Delta V\%}{\Delta V\%} \right), \text{ k}\Omega$$

Caution: Noise injected into the TRIM node may affect accuracy of the output voltage and stability of the POL converter. Always minimize the PCB trace length from the TRIM pin to external components to avoid noise pickup.

Refer to No-Bus™ POL Converters. Z-1000 Series Application Note on www.power-one.com for more application information on this and other product features.

10. Mechanical Drawings

All Dimensions are in mm

Tolerances:

0.5-10 ±0.1

10-100 ±0.2

Pin Coplanarity: 0.1 max

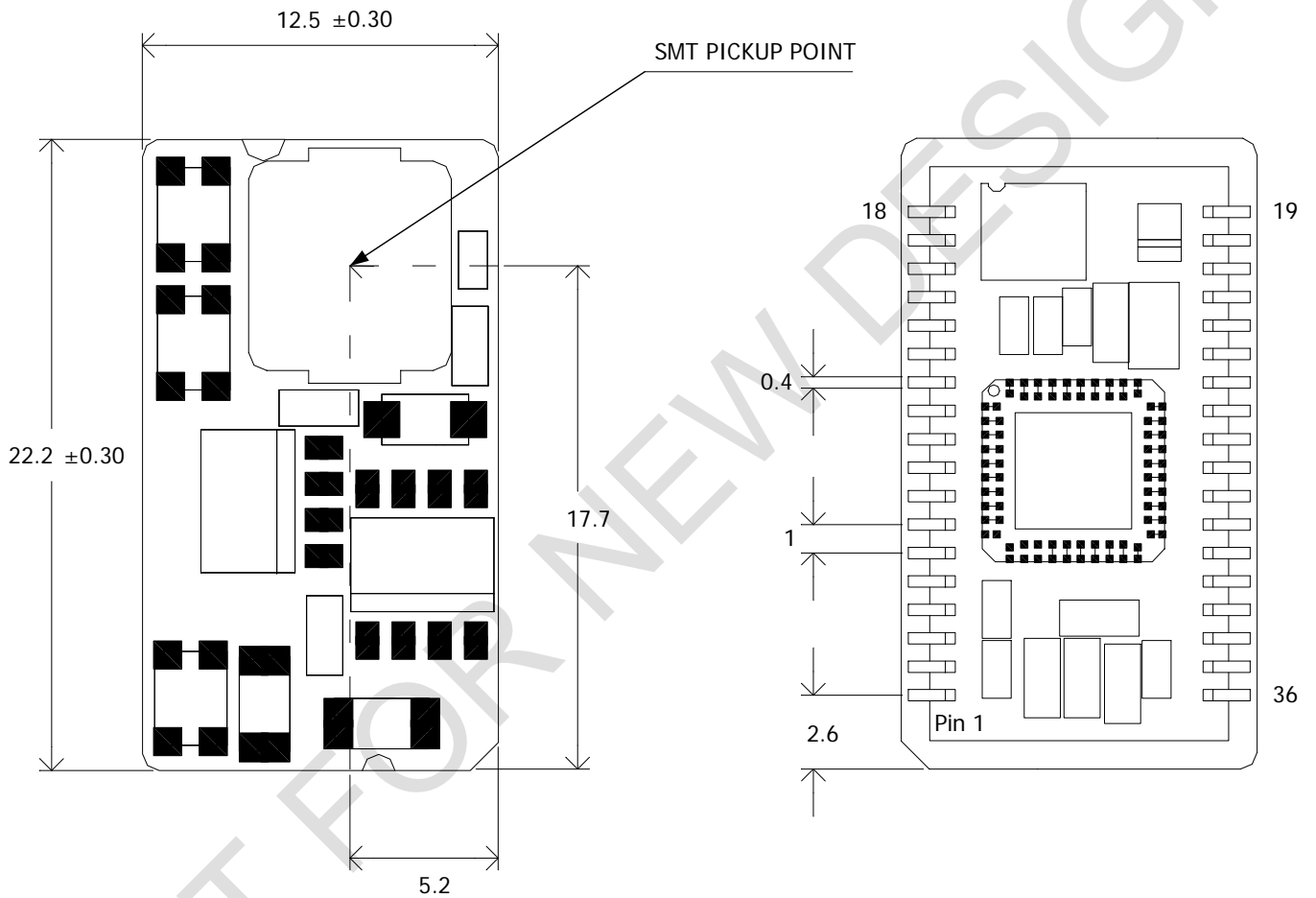

Figure 21. Top (Left) and Bottom Views

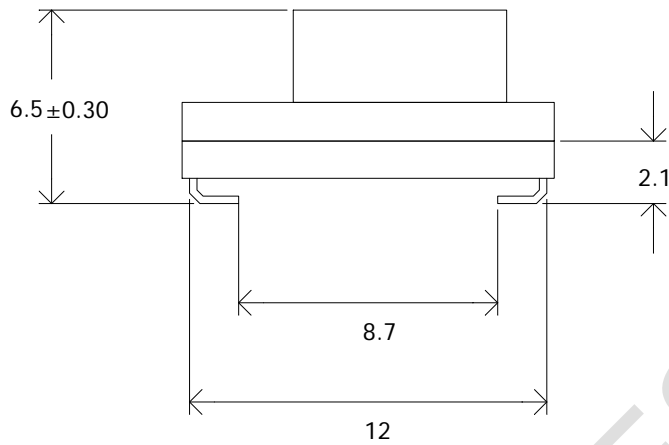

Figure 22. Side View

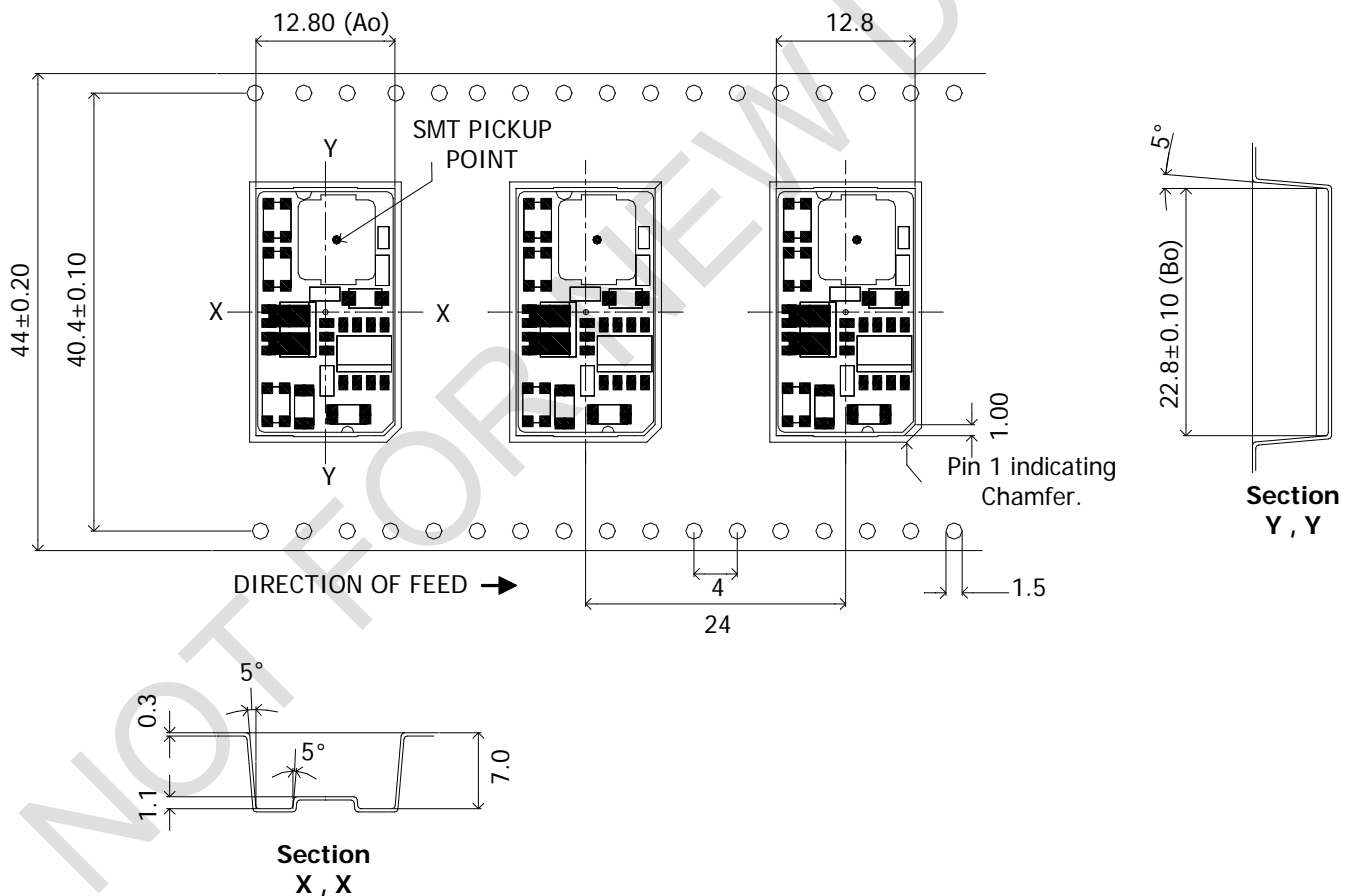

Figure 23. Tape and Reel

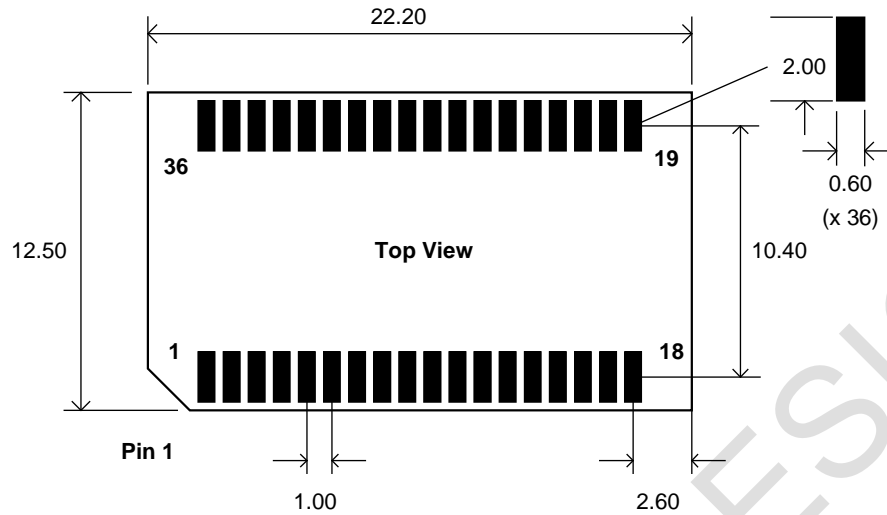

Figure 24. Recommended PCB Pad Sizes

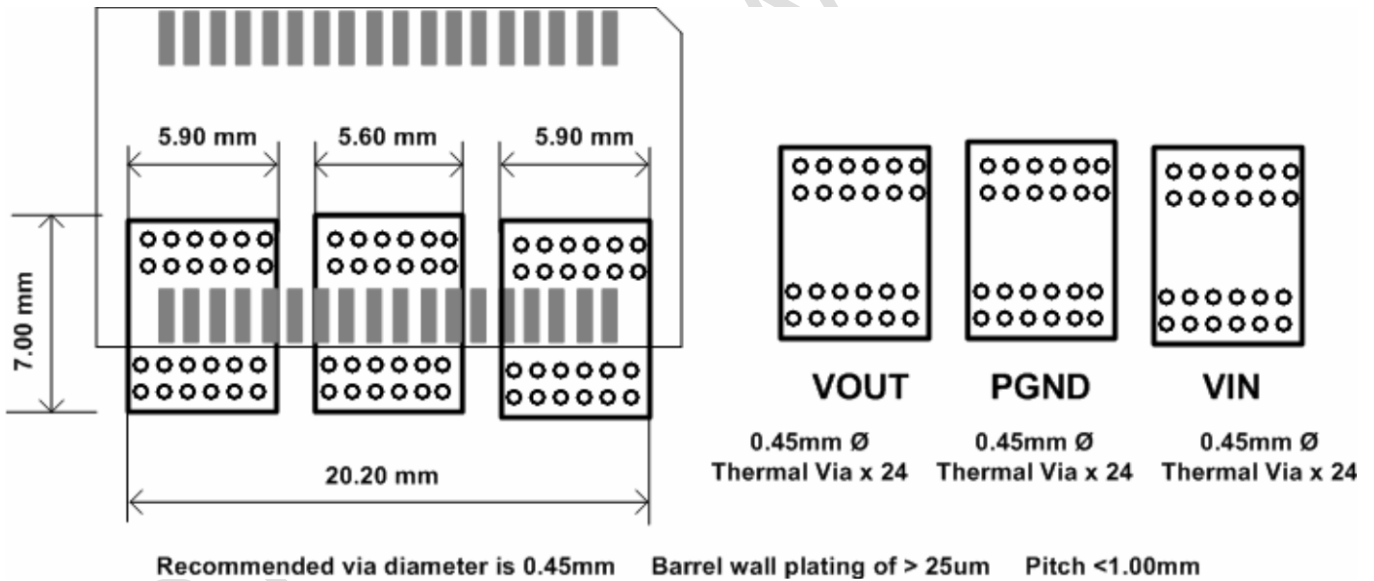



Figure 25. Recommended PCB Layout for Multilayer PCBs

Notes:

1. NUCLEAR AND MEDICAL APPLICATIONS - Power-One products are not designed, intended for use in, or authorized for use as critical components in life support systems, equipment used in hazardous environments, or nuclear control systems without the express written consent of the respective divisional president of Power-One, Inc.
2. TECHNICAL REVISIONS - The appearance of products, including safety agency certifications pictured on labels, may change depending on the date manufactured. Specifications are subject to change without notice.

Looking for pricing, stock, or lifecycle information?

Click below to explore more details on WIN SOURCE:

-  [View ZY1207HG-T3 on WIN SOURCE](#)
-  [Bel Power Solutions Information](#)

Optimize Your Supply Chain with WIN SOURCE Solutions

-  Global Sourcing Solution
-  Obsolete Management
-  Cost Control Management
-  Shortage Management
-  Alternative Solution
-  Excess Inventory Management