



**THE DATASHEET OF
NFP0QSN112HL2D**



Common Mode Noise Filter
NFP0QSN□□□HL2□ **Reference Specification**

1. Scope

This reference specification applies to Chip Common Mode Noise Filter NFP0QSN Series.

2. Part Numbering

(ex.) NF P 0Q S N 121 H L 2 D
 (1) (2) (3) (4) (5) (6) (7) (8) (9) (10)

- | | |
|-------------------------------------|--|
| (1) Chip Common Mode Noise Filter | (6) Common Mode Insertion Loss Characteristic Resonant Frequency(Typ.) |
| (2) Structure (P : Film Type) | (7) Circuit H : Characteristic Impedance 100Ω system |
| (3) Dimension (L×W) 0Q : 0.65×0.5mm | (8) Features |
| (4) Type | (9) Number of Line |
| (5) Category N : General Use | (10) Packaging Code D : Taping / B : Bulk |

3. Rating

Customer Part Number	MURATA Part Number	Common Mode Insertion Loss Characteristic (dB Typ.)				
		240 MHz	700 MHz	900 MHz	1.7 GHz	2.4 GHz
	NFP0QSN112HL2D	14	24	26	24	20
	NFP0QSN112HL2B					
	NFP0QSN122HL2D	12	23	26	25	21
	NFP0QSN122HL2B					

MURATA Part Number	Common Mode Impedance (Ω typ.) at 100MHz (Under Standard Testing Condition)	Rated Current (mA)	Rated Voltage (V(DC))	Withstanding Voltage (V(DC))	DC Resistance (Rdc) (Ω)	Insulation Resistance (I.R.) (Ω)
NFP0QSN112HL2D	90	100	5	12.5	3.0±30%	100M min.
NFP0QSN112HL2B						
NFP0QSN122HL2D	65	100	5		2.7±30%	
NFP0QSN122HL2B						

Operating Temperature : -40 to +85°C Storage Temperature : -40 to +85°C

4. Standard Testing Conditions

<Unless otherwise specified>
 Temperature : Ordinary Temperature 15 to 35°C
 Humidity : Ordinary Humidity 25 to 85%(RH)

<In case of doubt>
 Temperature : 20 ± 2°C
 Humidity : 60 to 70%(RH)
 Atmospheric Pressure : 86 to 106kPa

5. Style and Dimensions

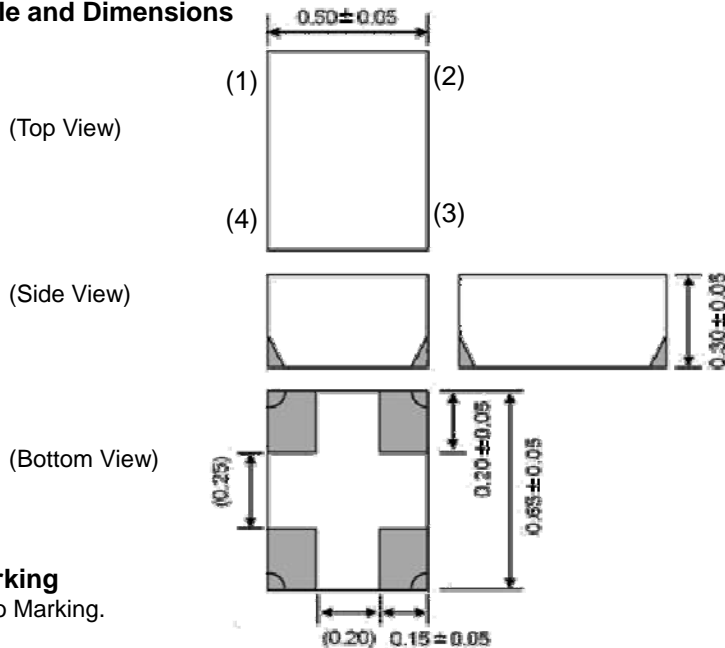

■ Equivalent Circuits

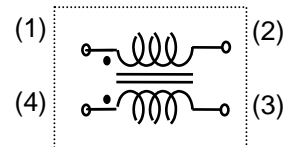

No polarity.

■ Unit Mass(Typical value)
0.5mg

6. Marking

No Marking.

7. Electrical Performance

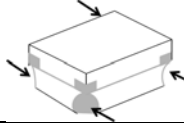
No.	Item	Specification	Test Method
7.1	Common Mode Impedance	Meet item 3.	Measuring Frequency : 100±1MHz (ref.item 10.) Measuring Equipment : Agilent 4291A or the equivalents (In case of doubt in standard condition, the heat treatment(200°C, about 10 minutes)shall be applied.
7.2	Withstanding Voltage	Products shall not be damaged.	Test Voltage : 2.5 times for Rated Voltage Time : 1 to 5 seconds Charge Current : 1 mA max.(ref.item 10.)
7.3	DC Resistance (Rdc)	Meet item 3.	Measuring current : 100mA max.(ref.item 10.) 
7.4	Insulation Resistance (I.R.)		Measuring voltage : Rated Voltage Measuring time : 1 minute max. (ref.item 10.)
7.5	Rated Current	Self- temperature rise shall be limited to 25°C max.	The rated current is applies.

8. Mechanical Performance

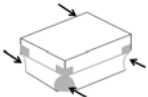
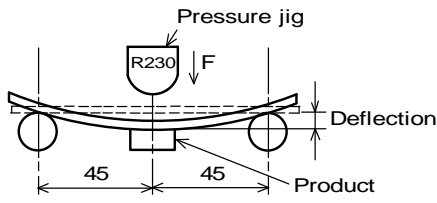
No.	Item	Specification	Test Method
8.1	Appearance and Dimensions	Meet item 5.	Visual Inspection and measured with Slide Calipers.
8.2	Solderability	The electrodes shall be at least 95% covered with new solder coating. 	Flux : Ethanol solution of rosin,25(wt)% Pre-Heating : 150±10°C, 60~90s Solder : Sn-3.0Ag-0.5Cu Solder Temperature : 240±3°C Immersion Time : 3±0.5s Immersion and emersion rates : 25 mm / s
8.3	Resistance to Soldering Heat	Meet Table 1. <u>Table 1</u>	Flux : Ethanol solution of rosin,25(wt)% Pre-Heating : 150±10°C, 60~90s Solder : Sn-3.0Ag-0.5Cu Solder Temperature : 270±5°C Immersion Time : 5±1s Immersion and emersion rates : 25 mm / s Then measured arter exposure in the room condition for 4 to 48 hours.
8.4	Drop	DC Resistance Change	
8.5	Vibration		It shall be soldered on the substrate. Oscillation Frequency : 10 to 2000 to 10Hz for 15 minutes Total amplitude : 3.0 mm or Acceleration amplitude 196 m/s ² whichever is smaller. Testing Time : A period of 2 hours in each of 3 mutually perpendicular directions.
8.6	Bending Strength	Meet Table 2. <u>Table 2</u>	Substrate : (t =1.0 mm). Deflection : 3 mm Speed of Applying Force : 1.0 mm / s Keeping time : 5 seconds 

9.Environmental Performance (Products shall be soldered on the glass-epoxy substrate)

No.	Item	Specification	Test Method
9.1	Temperature Cycle	Meet Table 1.	1 Cycle Step 1 -40°C(+0°C,-3°C) / 30(+3,-0) min Step 2 Ordinary Temp. / within 3 min Step 3 +85(+3°C,-0°C) / 30(+3,-0) min Step 4 Ordinary Temp. / within 3 min Total of 100 cycles. Then measured after exposure in the room condition for 4 to 48 hours.
9.2	Humidity		Temperature : 40±2°C Humidity : 90 to 95 % (RH) Time : 1000 hours(+48 hours,-0 hours) Then measured after exposure in the room condition for 4 to 48 hours.
9.3	Heat life		Temperature : 85±2°C Test Voltage : 2 times for Rated Voltage Time : 1000 hours(+48 hours,-0 hours) Then measured after exposure in the room condition for 4 to 48 hours. (ref. Item 10.)
9.4	Cold Resistance		Temperature : -40± 2°C Time : 1000 hours(+48 hours,-0 hours) Then measured after exposure in the room condition for 4 to 48 hours.

10. Terminal to be Tested.

When measuring and supplying the voltage,the following terminal is applied.

No.	Item	Terminal to be Tested
10.1	Common Mode Impedance	
10.2	Withstanding Voltage Insulation Resistance Heat Life	
10.3	DC Resistance	

11. Measuring method for common mode impedance.

Measured common mode impedance may be included measurement error due to stray capacitance, residual inductance of test fixture.

To correct this error, the common mode impedance should be calculate as follows;

- (1) Measure admittance of the fixture(opened), G_o B_o .
- (2) Measure impedance of the fixture(shorted), R_s X_s .
- (3) Measure admittance of the specimen, G_m B_m .
- (4) Calculate corrected impedance $|Z|$ using the formula below.

$$|Z| = (R_x^2 + X_x^2)^{1/2}$$

Where

$$R_x = \frac{G_m - G_o}{(G_m - G_o)^2 + (B_m - B_o)^2} - R_s$$

$$X_x = \frac{-(B_m - B_o)}{(G_m - G_o)^2 + (B_m - B_o)^2} - X_s$$

12. P.C.B., Flux, Solder and Soldering condition

Test shall be done using P.C.B., Flux, Solder and Soldering condition which are specified in item 16 except the case of being specified special condition.

13. Impedance Frequency Characteristics(Typical)

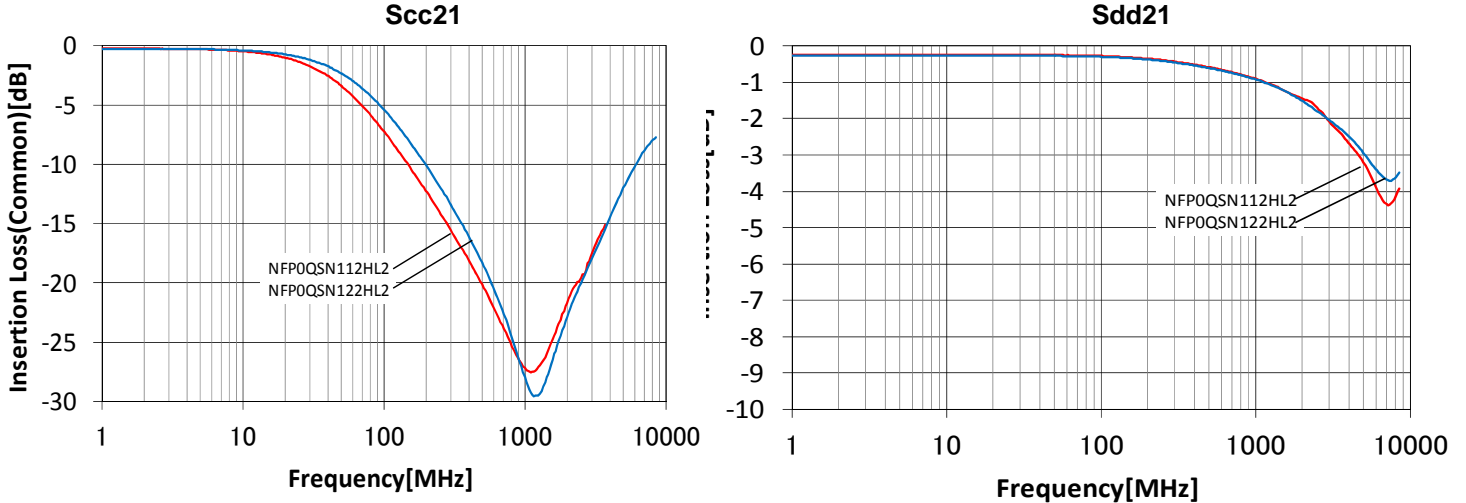

14. Specification of Packaging

14.1 Appearance and Dimensions (8mm-wide, 2mm pitch paper tape)

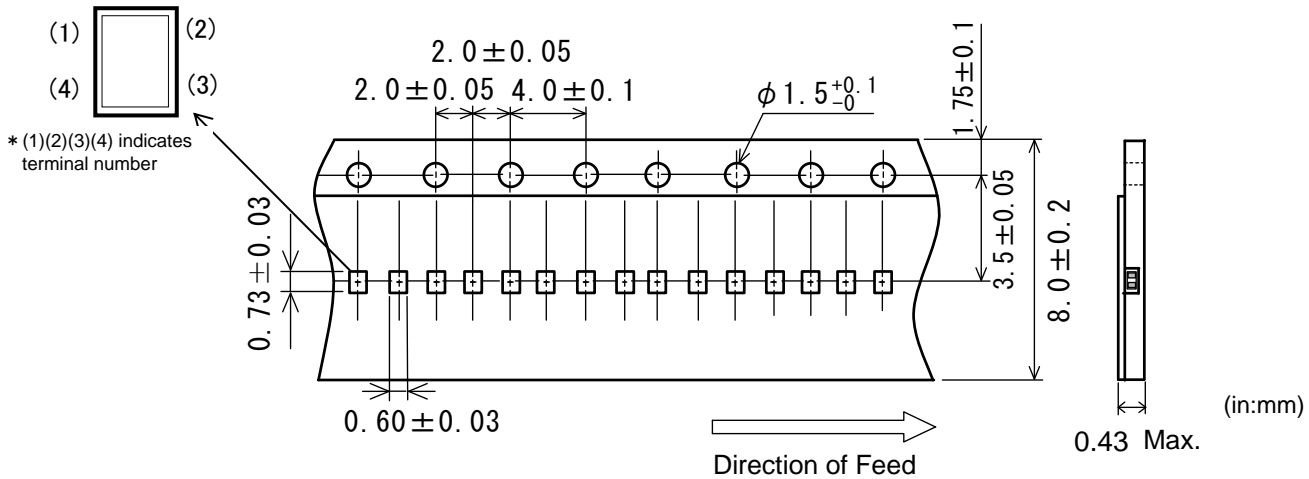

14.2 Specification of Taping

- (1) Packing quantity(Standard quantity) 15000 pcs. / reel
- (2) Taping
 - Products shall be packaged in the cavity of the base tape(paper tape) of 8mm-wide, 2mm-pitch continuously and sealed by cover tape .
- (3) Sprocket hole: The sprocket holes are to the right as the tape is pulled toward the user.
- (4) Spliced point: The base tape and cover tape have no spliced point
- (5) Cavity: There shall not be burr in the cavity.
- (6) Missing components number
 - Missing components number within 0.1% of the number per reel or 1 pc., whichever is greater, and are not continuous. The specified quantity per reel is kept.

14.3 Pull Strength of Plastic Tape

Paper Tape	5N min.
Cover Tape	10N min.

14.4 Peeling off force of Cover Tape

0.1 to 0.6N(Minimum value is Typical)
 Speed of Peeling off : 300 mm/min.

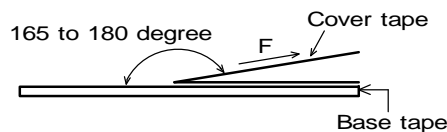

14.5 Dimensions of Leader-tape, Trailer and Reel

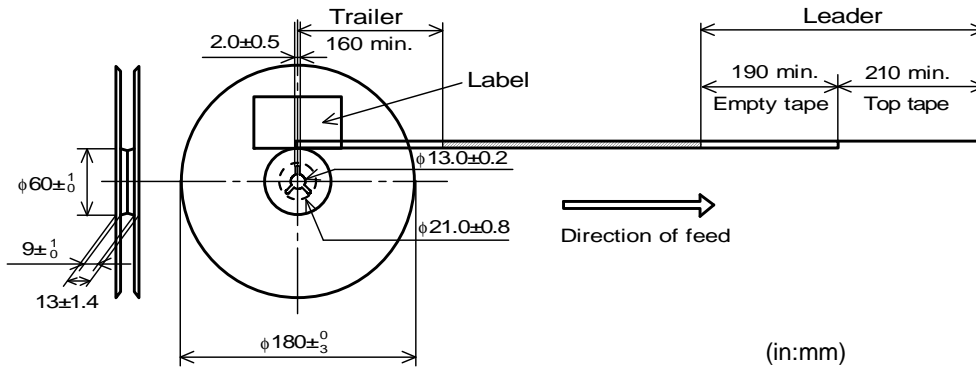

14.6 Marking for reel

Customer part number, MURATA part number, Inspection number(*1), RoHS marking(*2), Quantity, etc

*1) « Expression of Inspection No. »

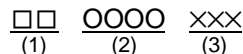

- (1) Factory Code
- (2) Date

First digit : Year / Last digit of year
 Second digit : Month / Jan. to Sep. → 1 to 9, Oct. to Dec. → O, N, D
 Third, Fourth digit : Day

- (3) Serial No.

*2) « Expression of RoHS marking »

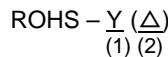

- (1) RoHS regulation conformity parts.
- (2) MURATA classification number

14.7 Marking for Outside package

Customer name Purchasing Order Number, Customer Part Number, MURATA part number, RoHS marking(*2), Quantity, etc

14.8 Specification of Outer Case

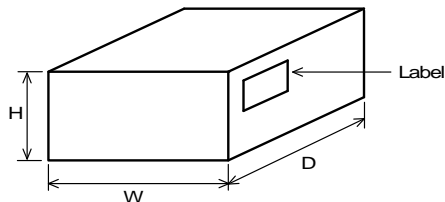

Outer Case Dimensions (mm)			Standard Reel Quantity in Outer Case (Reel)
W	D	H	
186	186	93	5

* Above Outer Case size is typical. It depends on a quantity of an order.

15. ⚠ Caution

15.1 Mounting Direction

Mount products in right direction.

Wrong direction which is 90° rotated from right direction causes not only open or short circuit but also flames or other serious trouble.

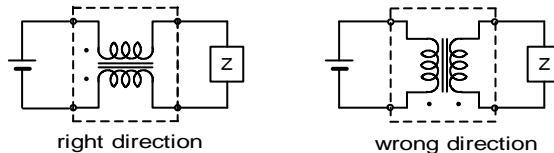

15.2 Limitation of Applications

Please contact us before using our products for the applications listed below which require especially high reliability for the prevention of defects which might directly cause damage to the third party's life, body or property.

- (1) Aircraft equipment
- (2) Aerospace equipment
- (3) Undersea equipment
- (4) Power plant control equipment
- (5) Medical equipment
- (6) Transportation equipment (vehicles, trains, ships, etc.)
- (7) Traffic signal equipment
- (8) Disaster prevention / crime prevention equipment
- (9) Data-processing equipment
- (10) Applications of similar complexity and / or reliability requirements to the applications listed in the above.

16. Notice

This product is designed for solder mounting. (reflow soldering only)
Please consult us in advance for applying other mounting method such as conductive adhesive.

16.1 Flux and Solder

Flux	Use rosin-based flux, but not highly acidic flux (with chlorine content exceeding 0.2(wt)%.) Do not use water-soluble flux.
Solder	Use Sn-3.0Ag-0.5Cu solder Use of Sn-Zn based solder will deteriorate performance of products. In case of using Sn-Zn based solder, please contact Murata in advance.

16.2 Assembling

<Thermal Shock>

Pre-heating should be in such a way that the temperature difference between solder and ceramic surface is limited to 100°C MAX. Also cooling into solvent after soldering should be in such a way that the temperature difference is limited to 100°C max.

16.3 Resin coating

The impedance value may change and/or it may affect on the product's performance due to high cure-stress of resin to be used for coating / molding products. So please pay your careful attention when you select resin. In prior to use, please make the reliability evaluation with the product mounted in your application set.

16.4 Attention regarding P.C.B. bending

The following shall be considered when designing and laying out P.C.B.'s.

(1) P.C.B. shall be designed so that products are not subject to the mechanical stress due to warping the board.

[Products direction]

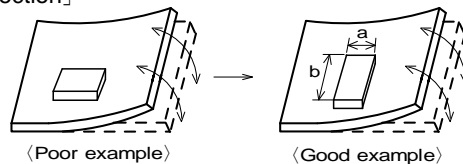

Products shall be location the sideways Direction (Length : $a < b$) to the machanical Stress.

[Wrapping direction]

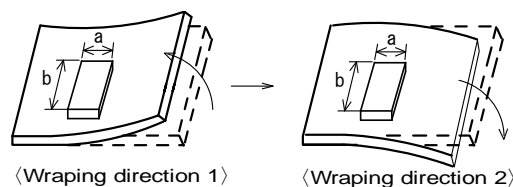

Products(wrapping direction 1, wrapping direction 2) shall be located carefully so that products are not subject to the mechanical stress due to warping the board. Because they may be subjected the mechanical stress in order of wrapping direction 1>wrapping direction 2.

(2)Products location on P.C.B. separation

Products(A,B,C,D) shall be located carefully so that products are not subject to the mechanical stress due to warping the board. Because they may be subjected the mechanical stress in order of $A > C > B \cong D$.

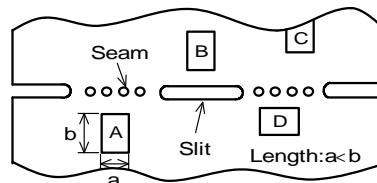
**16.5 Attention Regarding P.C.B. Design**

< The Arrangement of Products >

P.C.B. shall be designed so that products are far from the portion of perforation.

The portion of perforation shall be designed as narrow as possible, and shall be designed so as not to be applied the stress in the case of P.C.B. separation.

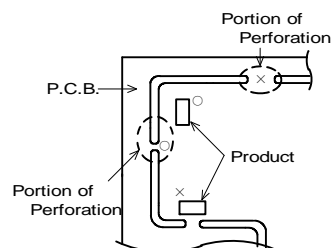

Products shall not be arranged on the line of a series of holes when there are big holes in P.C.B.
 (Because the stress concentrate on the line of holes.)

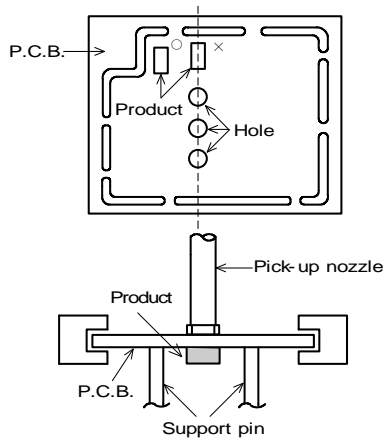

< Products Placing >

Support pins shall be set under P.C.B. to prevent causing a warp to P.C.B. during placing the products on the other side of P.C.B.

< P.C.B. Separation >

P.C.B. shall not be separated with hand.
 P.C.B. shall be separated with the fixture so as not to cause P.C.B. bending.

16.6 Attention Regarding P.C.B. Mounting

In case of mounting by use of mounting machine, please choose nozzle which can pick up components of 0603 size.

16.7 Standard Land Dimensions

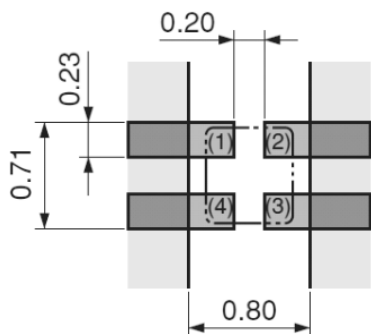

* (1)(2)(3)(4) indicates terminal number.

- Land Pattern
- + Solder Resist
- Land Pattern
- Solder Resist (in: mm)

16.8 Soldering(Reflow soldering)

Standard soldering profile and the limit soldering profile is as follows.
 The excessive limit soldering conditions may cause leaching of the electrode and / or resulting in the deterioration of product quality.

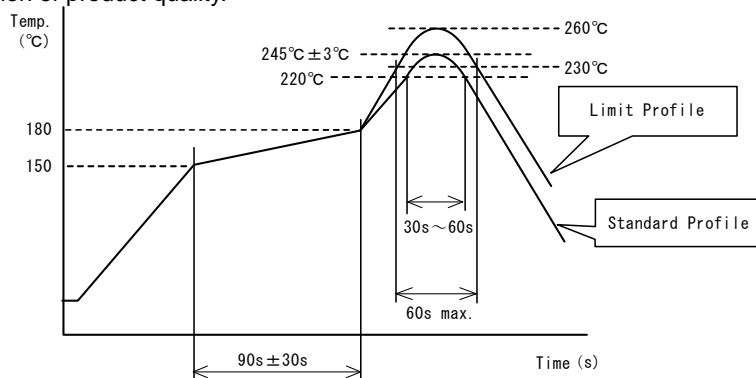

	Standard Profile	Limit Profile
Pre-heating	150~180°C、90s±30s	
Heating	above 220°C、30s~60s	above 230°C、60s max.
Peak temperature	245±3°C	260°C、10s
Cycle of reflow	2 times	2 times

- (1) Standard printing pattern of solder paste
 - Standard thickness of the solder paste should be 100 to 150 μ m.
 - Use the solder paste printing pattern of the right pattern.
 - For the resist and copper foil pattern, use standard land dimensions.
 - Use Sn-3.0Ag-0.5Cu solder.

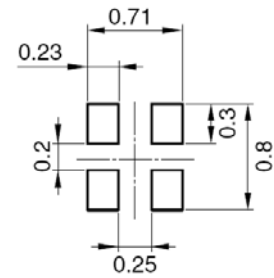

(in: mm)

- (2) Reworking with Soldering iron
This product can not rework with soldering iron.

- (3) Solder Volume
Solder shall be used not to be exceeded the upper limits as shown below.



Accordingly increasing the solder volume, the mechanical stress to product is also increased. Excessive solder volume may cause the failure of mechanical or electrical performance.

16.9 Cleaning Conditions

Products shall be cleaned on the following conditions.

- (1) Cleaning temperature shall be limited to 60°C max. (40°C max. for Isopropyl alcohol.)
- (2) Ultrasonic cleaning shall comply with the following conditions, avoiding the resonance phenomenon at the mounted products and P.C.B..
 - Power : 20W/ l max. • Frequency : 28kHz to 40kHz • Time : 5 minutes max.
- (3) Cleaner
 1. Alternative cleaner • Isopropyl alcohol (IPA)
 2. Aqueous agent • PINE ALPHA ST-100S
- (4) There shall be no residual flux and residual cleaner after cleaning.
In the case of using aqueous agent, products shall be dried completely after rinse with de-ionized water in order to remove the cleaner.
- (5) Other cleaning
Please contact us.

16.10 Handling of a substrate

After mounting products on a substrate, do not apply any stress to the product caused by bending or twisting to the substrate when cropping the substrate, inserting and removing a connector from the substrate or tightening screw to the substrate.

Excessive mechanical stress may cause cracking in the product.

Bending

Twisting



16.11 Operating Environment

Do not use this product under the following environmental conditions, on deterioration of the performance, such as insulation resistance may result from the use.

- (1) in corrosive gases (acidic gases, alkaline gases, chlorine, sulfur gases, organic gases and etc.)
- (2) in the atmosphere where liquid such as organic solvent, may splash on the products.

16.12 Storage Conditions

(1) Storage period

Use the products within 12 months after delivered.

Solderability should be checked if this period is exceeded.

(2) Storage environment condition

- Products should be stored in the warehouse on the following conditions.

Temperature : -10 to +40°C

Humidity : 15 to 85% relative humidity

No rapid change on temperature and humidity

- Products should not be stored in corrosive gases, such as sulfurous, acid gases, alkaline gases, to prevent the following deterioration.

Poor solderability due to the oxidized electrode.

- Products should be stored on the palette for the prevention of the influence from humidity, dust and so on.
- Products should be stored in the warehouse without heat shock, vibration, direct sunlight and so on.
- Products should be stored under the airtight packaged condition.

(3) Delivery

Care should be taken when transporting or handling product to avoid excessive vibration or mechanical shock.

17.  Note



(1) Please make sure that your product has been evaluated in view of your specifications with our product being mounted to your product.

(2) You are requested not to use our product deviating from the agreed specifications.

(3) The contents of this reference specification are subject to change without advance notice. Please approve our product specifications or transact the approval sheet for product specifications before ordering.

Looking for pricing, stock, or lifecycle information?

Click below to explore more details on WIN SOURCE:

-  [View NFP0QSN112HL2D on WIN SOURCE](#)
-  [Murata Electronics North America Information](#)

Optimize Your Supply Chain with WIN SOURCE Solutions

-  Global Sourcing Solution
-  Obsolete Management
-  Cost Control Management
-  Shortage Management
-  Alternative Solution
-  Excess Inventory Management