



**THE DATASHEET OF  
AZ770-1C-24DE**



## SPDT SUBMINIATURE POWER RELAY

### FEATURES

- 5 kV dielectric strength, 10 kV surge
- 8 mm creepage and clearance
- Proof tracking index (PTI/CTI) 250
- 5 A switching capability (high capacity version: 10 A)
- 20 A high inrush current (1 Form A)
- Epoxy sealed version available
- UL Class F insulation (155°C) standard
- EN 60335-1 (GWT) approved version available
- Reinforced insulation, EN 60730-1 (VDE 0631, part 1), 1 Form A: EN 60335-1 (VDE 0700, part 1)
- UL, CUR file E44211
- VDE certificate 40006815



### CONTACTS

<b>Arrangement</b>	SPST (1 Form A), SPDT (1 Form C)
<b>Ratings (max.)</b> switched power switched current switched voltage	(resistive load) 150 W or 1250 VA 5 A 30 VDC* or 400 VAC
High cap. version switched power switched current switched voltage	150 W or 2500 VA 10 A 30 VDC* or 400 VAC
<b>Rated Loads</b> UL	<b>1 Form A</b> 5 A at 250 VAC, resistive, 100k cycles 5 A at 30 VDC, resistive, 100k cycles 3 A at 250 VAC, cos phi 0.4, 100k cycles 1/8 HP at 125/250 VAC, 100k cycles C300 pilot duty, 125/250 VAC, 100k cycles TV-2 at 120 VAC <b>1 Form C</b> 3 A at 250 VAC, resistive, 100k cycles 3 A at 30 VDC, resistive, 100k cycles
VDE	<b>1 Form A</b> 5 A at 250 VAC, 85°C, 100k cycles 2 A at 250 VAC, cos phi 0.5, 85°C, 30k cycles 3 A at 400 VAC, 85°C, 100k cycles * 5 A at 30 VDC, 85°C, 10k cycles * sensitive coil version only <b>1 Form C</b> 3 A at 250 VAC, 85°C, 100k cycles 5 A at 250 VAC, 85°C, 100k cycles ** 2 A at 250 VAC, cos phi 0.5, 85°C, 30k cycles ** ** change-over contact tested as make contact
High cap. version UL	10 A at 250 VAC, resistive, 85°C, 100k cycles 15 A at 120 VAC, resistive, 70°C, 6k cycles B300 pilot duty, 40°C 1000 W, 250 VAC, tungsten load, 40°C, 6k cycles
VDE	10 A at 250 VAC, 85°C, 15k cycles 6 A at 250 VAC, 85°C, 100k cycles *** *** standard coil version only
<b>Contact materials</b>	Silver nickel (standard version) Silver tin oxide (high capacity version) Gold plating available
<b>Initial resistance</b>	< 100 mΩ

### GENERAL DATA

<b>Life Expectancy</b> mechanical electrical High cap. version mechanical electrical	(minimum operations) 1 x 10 <sup>6</sup> 1 x 10 <sup>5</sup> at 5 A 250 VAC resistive 1 x 10 <sup>6</sup> 1 x 10 <sup>5</sup> at 10 A 250 VAC resistive
<b>Operate Time</b>	8 ms (max.) at nominal coil voltage
<b>Release Time</b>	4 ms (max.) at nominal coil voltage, without coil suppression
<b>Dielectric Strength</b>	(at sea level for 1 min.) 5000 V <sub>RMS</sub> coil to contact 1000 V <sub>RMS</sub> between open contacts
<b>Surge voltage</b> coil to contact	10,000 V (at 1.2 x 50 μs)
<b>Insulation Resistance</b>	1000 MΩ (min.) at 20°C, 500 VDC, 50% RH
<b>Insulation</b>	(according to DIN VDE 0110, IEC 60664-1) C250 Overvoltage category: III, Pollution degree: 3, Nominal voltage: 250 VAC
<b>Temperature Range</b> operating	(at nominal coil voltage) -40°C (-40°F) to 85°C (185°F)
<b>Vibration resistance</b>	1.5 mm (0.062") DA at 10–55 Hz N.C. contact: 0.6 mm (0.024") if vibration is in length direction
<b>Shock</b>	10 g operating, 100 g damage
<b>Enclosure</b> type material group	P.B.T. polyester flux proof, wash tight IIIa
<b>Terminals</b>	Tinned copper alloy, P. C.
<b>Soldering</b> max. Temperature max. Time	270°C (518°F) 5 seconds
<b>Cleaning</b> max. Solvent Temp. max. Immersion Time	80°C (176°F) 30 seconds
<b>Dimensions</b> length width height	17.85 mm (0.703") 10.35 mm (0.407") 12.95 mm (0.510")
<b>Weight</b>	4.6 grams (approx.)
<b>Packing unit in pcs</b>	100 per tray / 1000 per carton box
<b>Compliance</b>	UL 508, IEC 61810-1, IEC60335-1 (GWT), RoHS, REACH

# AZ770

## COIL

<b>Nominal coil DC voltages</b>	see coil voltage specifications tables
<b>Dropout</b>	> 5% of nominal coil voltage
<b>Nominal power</b> standard coil sensitive coil - standard version sensitive coil - high cap. Version	(approx.) 450 mW 200 mW 230 mW
<b>Power at pickup voltage</b> standard coil sensitive coil - standard version sensitive coil - high cap. Version	(typ.) 253 mW 113 mW 130 mW
<b>Max. continuous dissipation</b>	760 mW at 20°C (68°F) ambient
<b>Temperature Rise</b> standard coil sensitive coil - standard version sensitive coil - high cap. Version	(at nominal coil voltage) 41 K (74°F) 22 K (40°F) 27 K (49°F)
<b>Max. temperature</b>	155°C (311°F)

## COIL VOLTAGE SPECIFICATIONS

### Standard Coil

Nominal Coil VDC	Must Operate VDC	Max. Continuous VDC	Resistance Ohm ± 10%
3	2.25	3.9	20
5	3.75	6.6	55
6	4.5	7.8	80
9	6.75	11.7	180
12	9.0	15.6	320
18	13.5	23.4	720
24	18.0	31.2	1280
48	36.0	62.4	5120

### Sensitive Coil - Standard Version

Nominal Coil VDC	Must Operate VDC	Max. Continuous VDC	Resistance Ohm ± 10%
3	2.25	5.1	45
5	3.75	8.5	125
6	4.5	10.2	180
9	6.75	15.3	400
12	9.0	20.4	720
18	13.5	30.6	1600
24	18.0	40.8	2800

### Sensitive Coil - High Capacity Version

Nominal Coil VDC	Must Operate VDC	Max. Continuous VDC	Resistance Ohm ± 10%
3	2.25	5.1	38
5	3.75	8.5	108
6	4.5	10.2	155
9	6.75	15.3	350
12	9.0	20.4	620
18	13.5	30.6	1390
24	18.0	40.8	2480
48	36.0	81.6	9920

Note: All values at 23°C (73°F), upright position, terminals downward.

## ORDERING DATA

### Standard Version

AZ770-□□-□□D□□□□□□

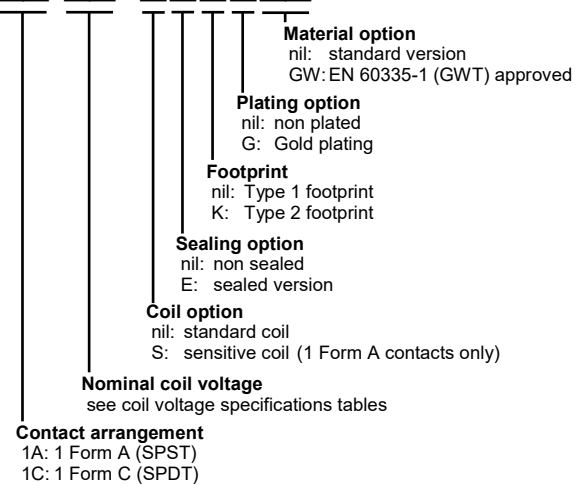

### High Capacity Version

AZ770T-1AE-□□D□□□□□□

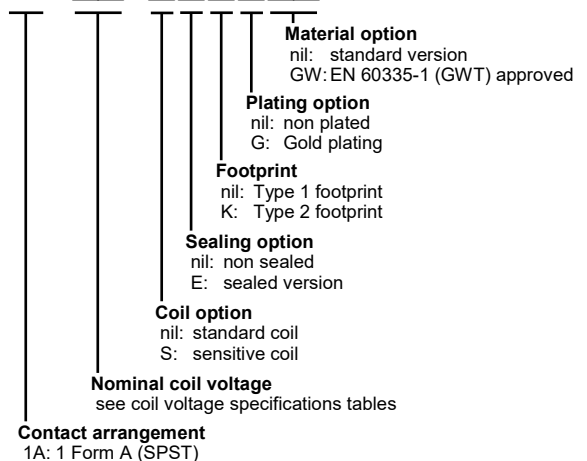

### Example ordering data

- AZ770-1A-5D Standard version, 1 Form A, 5 VDC nominal coil voltage, standard coil, non sealed, type 1 footprint, non gold plated
- AZ770-1C-12DSEG Standard version, 1 Form C, 12 VDC nominal coil voltage, sensitive coil, sealed, type 1 footprint, gold plated
- AZ770T-1AE-24DS High capacity version, 1 Form A, 24 VDC nominal coil voltage, sensitive coil, non sealed, type 1 footprint, non gold plated
- AZ770-1A-9DSGW Standard version, 1 Form A, 9 VDC nominal coil voltage, sensitive coil, EN 60335-1 (GWT) approved

# AZ770

## MECHANICAL DATA

Dimensions in inches with metric equivalents in parentheses. Tolerance:  $\pm .010$ "

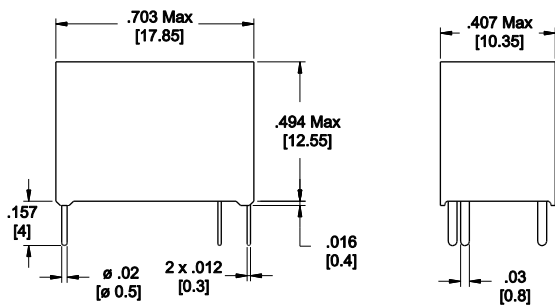

**Type 1**

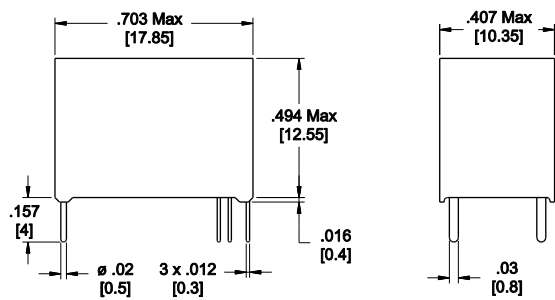

**Type 2**

## WIRING DIAGRAMS

Viewed towards terminals.  
Shown in deenergized condition.

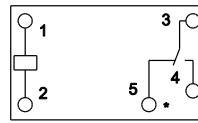

**Type 1**

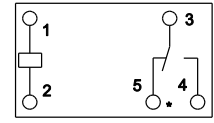

**Type 2**

\* Not used on 1 Form A version

## NOTES

1. All values at reference temperature of 23°C (73°F) unless stated otherwise.
2. Relay may pull in with less than "Must Operate" value.
3. Coil suppression circuits such as diodes, etc. in parallel to the coil will lengthen the release time.
4. Relay adjustment may be affected if excessive shock is applied to the relay.
5. Relay adjustment may be affected if undue pressure is exerted on the relay case.
6. Specifications subject to change without notice.

## PC BOARD LAYOUT

Recommendation for PC board layout.  
Dimensions in inches with metric equivalents in parentheses.  
Viewed towards terminals.

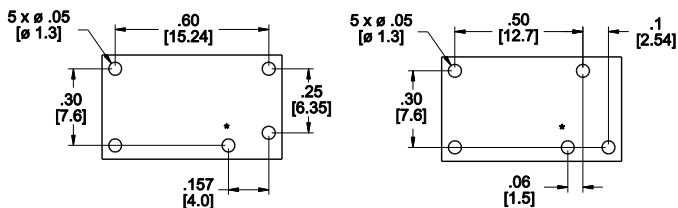

**Type 1**

**Type 2**

\* Not used on 1 Form A version

# AZ770

## DISCLAIMER

This product specification is to be used in conjunction with the application notes which can be downloaded from the regional ZETTLER relay websites. The specification provides an overview of the most significant part features. Any individual applications and operating conditions are not taken into consideration. It is recommended to test the product under application conditions. Responsibility for the application remains with the customer. Proper operation and service life cannot be guaranteed if the part is operated outside the specified limits.

## ZETTLER GROUP

Building on a foundation of more than a century of expertise in German precision engineering, ZETTLER Group is a world-class enterprise, engaged in the design, manufacturing, sales and distribution of electronic components. Our industry leadership is based on a unique combination of engineering competence and global scale.

For more information on other ZETTLER Group companies, please visit [zettler-group.com](http://zettler-group.com). For support on this product or other ZETTLER relays, please visit one of the group sites below.

## SITES FOR ZETTLER RELAYS

### NORTH AMERICA

American Zettler, Inc.  
[www.azettler.com](http://www.azettler.com)  
[sales@azettler.com](mailto:sales@azettler.com)

### EUROPE

Zettler Electronics, GmbH  
[www.zettlerelectronics.com](http://www.zettlerelectronics.com)  
[office@zettlerelectronics.com](mailto:office@zettlerelectronics.com)

Zettler Electronics, Poland  
[www.zettlerelectronics.pl](http://www.zettlerelectronics.pl)  
[office@zettlerelectronics.pl](mailto:office@zettlerelectronics.pl)

### CHINA

Zettler Group, China  
[www.zettlercn.com](http://www.zettlercn.com)  
[relay@zettlercn.com](mailto:relay@zettlercn.com)

### ASIA PACIFIC



Zettler Electronics (HK) Ltd.  
[www.zettlerhk.com](http://www.zettlerhk.com)  
[sales@zettlerhk.com](mailto:sales@zettlerhk.com)



# ZETTLER

## Looking for pricing, stock, or lifecycle information?

Click below to explore more details on WIN SOURCE:

-  [View AZ770-1C-24DE on WIN SOURCE](#)
-  [American Zettler, Inc. Information](#)

## Optimize Your Supply Chain with WIN SOURCE Solutions

-  Global Sourcing Solution
-  Obsolete Management
-  Cost Control Management
-  Shortage Management
-  Alternative Solution
-  Excess Inventory Management