



**THE DATASHEET OF
MAX6043AAUT50#TG16**



Precision High-Voltage Reference in SOT23

MAX6043

General Description

The MAX6043 precision voltage reference provides accurate preset +2.5V, +3.3V, +4.096V, +5.0V, and +10V reference voltages from up to +40V input voltages. The MAX6043 features a proprietary temperature coefficient curvature-correction circuit and laser-trimmed thin-film resistors that result in a very low temperature coefficient of 15ppm/°C (max) and excellent initial accuracy of 0.05% (max). Low temperature drift and low noise make the MAX6043 ideal for use with high-resolution A/D or D/A converters.

The MAX6043 draws 320µA of supply current and sources 10mA or sinks 0.6mA of load current. The MAX6043 uses bandgap technology for low-noise performance and excellent accuracy. The MAX6043 does not require an output bypass capacitor for stability, and is stable with capacitive loads up to 100µF. Eliminating the output bypass capacitor saves valuable board area in space-critical applications. The supply-independent, low supply current makes the MAX6043 ideal for battery-operated, high-performance systems.

The MAX6043 is available in a 6-pin SOT23 package and operates over the automotive (-40°C to +125°C) temperature range.

Applications

- Analog-to-Digital Converters
- Digital-to-Analog Converters
- Digital Voltmeters
- Voltage Regulators
- Threshold Detectors

Features

- +2.5V, +3.3V, +4.096V, +5.0V, or +10V Output Voltages
- Excellent Temperature Stability: 15ppm/°C (max)
- Tight Initial Accuracy: 0.05% (max)
- Tiny SOT23 Package
- Wide +4.5V to +40V Supply Voltage Range
- Low Noise: 4µV_{p-p} (typ at 2.5V Output)
- Short-Circuit Protected
- Wide Operating Temperature Range -40°C to +125°C
- Stable with Capacitive Loads from 0 to 100µF
- No External Capacitors Required for Stability

Pin Configuration

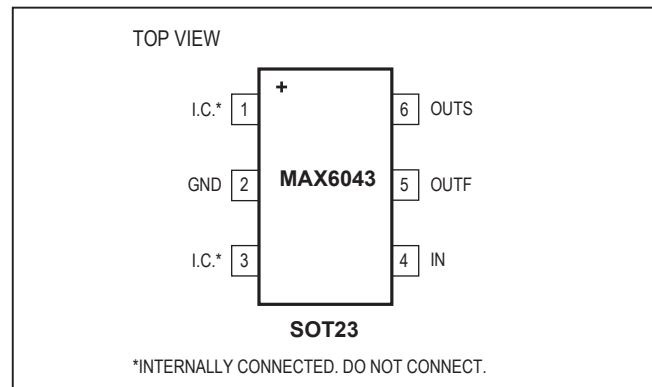

Ordering Information

PART	OUTPUT VOLTAGE (V)	TEMPCO (PPM/°C)	INITIAL ACCURACY (%)	TOP MARK
MAX6043BAUT25-T	2.500	20	0.10	ABDQ
MAX6043CAUT25-T	2.500	65	0.50	ABDR
MAX6043BAUT33-T	3.300	20	0.10	ABDS
MAX6043BAUT41-T	4.096	20	0.10	ABDU

#Denotes an RoHS-compliant device that may include lead that is exempt under the RoHS requirements.
T = Tape and reel.

Ordering Information continued at end of data sheet.
Typical Operating Circuit appears at end of data sheet.

19-3036; Rev 7; 11/21

Absolute Maximum Ratings

IN to GND-0.3V to +42V
 OUTF, OUTS to GND-0.3V to (V_{IN} + 0.3V)
 Continuous Power Dissipation (T_A = +70°C)
 6-Pin SOT23 (derate 7.40mW/°C above +70°C) ...595.20mW
 OUT_ Short-Circuit Duration 5s
 Operating Temperature Range -40°C to +125°C
 Storage Temperature Range -65°C to +150°C

Junction Temperature Range -65°C to +150°C
 Maximum Junction Temperature +150°C
 Lead Temperature (soldering, 10s) +300°C
 Soldering Temperature (reflow)
 RoHS-compliant package +245°C
 Packages containing lead (Pb) +240°C

Package Information

6 SOT23

PACKAGE CODE	U6F+6
Outline Number	21-0058
Land Pattern Number	90-0175
Thermal Resistance, Single-Layer Board	
Junction to Ambient (θ _{JA})	185.50°C/W
Junction to Case (θ _{JC})	75°C/W
Thermal Resistance, Four-Layer Board	
Junction to Ambient (θ _{JA})	134.40°C/W
Junction to Case (θ _{JC})	39°C/W

For the latest package outline information and land patterns (footprints), go to www.maximintegrated.com/packages. Note that a “+”, “#”, or “-” in the package code indicates RoHS status only. Package drawings may show a different suffix character, but the drawing pertains to the package regardless of RoHS status.

Package thermal resistances were obtained using the method described in JEDEC specification JESD51-7, using a four-layer board. For detailed information on package thermal considerations, refer to www.maximintegrated.com/thermal-tutorial.

Electrical Characteristics— $V_{OUT} = +2.5V$

($V_{IN} = +5V$, $I_{OUT} = 0$, $T_A = T_{MIN}$ to T_{MAX} . Typical values are at $T_A = +25^\circ C$, unless otherwise noted.) (Note 1)

PARAMETER	CONDITIONS		MIN	TYP	MAX	UNITS
OUTPUT						
Output Voltage	$I_{OUT} = 0$, $T_A = +25^\circ C$	MAX6043B (0.1%)	2.4975	2.5000	2.5025	V
		MAX6043C (0.5%)	2.4876	2.5000	2.5125	
Output-Voltage Temperature Coefficient (Note 2)	$T_A = -40^\circ C$ to $+125^\circ C$	MAX6043B_25		5	25	ppm/ $^\circ C$
		MAX6043C_25		10	65	
Line Regulation (Note 4)	$4.5V < V_{IN} < 40V$	$T_A = +25^\circ C$		1	6	ppm/V
		$T_A = -40^\circ C$ to $+125^\circ C$		1.5	10	
Load Regulation (Note 4)	Sourcing, $0 < I_{OUT} < 10mA$	$T_A = +25^\circ C$		8	70	ppm/mA
		$T_A = -40^\circ C$ to $+125^\circ C$			70	
	Sinking, $-0.6mA < I_{OUT} < 0mA$	$T_A = +25^\circ C$		70	900	
		$T_A = -40^\circ C$ to $+125^\circ C$			900	
OUT Short-Circuit Current	Output shorted to GND			60		mA
	Output shorted to IN			-2		
Thermal Hysteresis	(Note 3)			150		ppm
Long-Term Stability	$\Delta t = 1000hr$			150		ppm
DYNAMIC CHARACTERISTICS						
Output Noise Voltage	0.1Hz to 10Hz			4		μV_{P-P}
	10Hz to 1kHz			7		μV_{RMS}
Turn-On Settling Time	To $V_{OUT} = 0.05\%$ of final value, $C_{OUT} = 50pF$			150		μs
INPUT						
Supply Voltage Range	Inferred from line regulation test		4.5		40.0	V
Quiescent Supply Current	$I_{OUT} = 0$	$T_A = +25^\circ C$		320	490	μA
		$T_A = -40^\circ C$ to $+125^\circ C$		370	650	

Electrical Characteristics— $V_{OUT} = +3.3V$

($V_{IN} = +10V$, $I_{OUT} = 0$, $T_A = T_{MIN}$ to T_{MAX} . Typical values are at $T_A = +25^\circ C$, unless otherwise noted.) (Note 1)

PARAMETER	CONDITIONS		MIN	TYP	MAX	UNITS
OUTPUT						
Output Voltage	$I_{OUT} = 0$, $T_A = +25^\circ C$	MAX6043B (0.1%)	3.2967	3.3000	3.3033	V
		MAX6043C (0.5%)	3.2836	3.3000	3.3165	
Output-Voltage Temperature Coefficient (Note 2)	$T_A = -40^\circ C$ to $+125^\circ C$	MAX6043B_33		5	25	ppm/ $^\circ C$
		MAX6043C_33		10	65	
Line Regulation (Note 4)	$5.3V \leq V_{IN} \leq 40V$	$T_A = +25^\circ C$		1	6	ppm/V
		$T_A = -40^\circ C$ to $+125^\circ C$		1.5	10	
Load Regulation (Note 4)	Sourcing, $0 \leq I_{OUT} \leq 10mA$	$T_A = +25^\circ C$		23	70	ppm/mA
		$T_A = -40^\circ C$ to $+125^\circ C$			70	
	Sinking, $-0.6mA \leq I_{OUT} \leq 0mA$	$T_A = +25^\circ C$		100	900	
		$T_A = -40^\circ C$ to $+125^\circ C$			900	
OUT Short-Circuit Current	OUT shorted to GND			60		mA
	OUT shorted to IN			-2		
Thermal Hysteresis	(Note 3)			150		ppm
Long-Term Stability	$\Delta t = 1000hr$			150		ppm
DYNAMIC CHARACTERISTICS						
Output Noise Voltage	0.1Hz to 10Hz			5.3		μV_{P-P}
	10Hz to 1kHz			9.5		μV_{RMS}
Turn-On Settling Time	To $V_{OUT} = 0.05\%$ of final value, $C_{OUT} = 50pF$			180		μs
INPUT						
Supply Voltage Range	Inferred from line regulation test		5.3		40.0	V
Quiescent Supply Current	$I_{OUT} = 0$	$T_A = +25^\circ C$		320	490	μA
		$T_A = -40^\circ C$ to $+125^\circ C$		380	650	

Electrical Characteristics— $V_{OUT} = +4.096V$ (V_{IN} = +10V, I_{OUT} = 0, T_A = T_{MIN} to T_{MAX}. Typical values are at T_A = +25°C, unless otherwise noted.) (Note 1)

PARAMETER	CONDITIONS		MIN	TYP	MAX	UNITS
OUTPUT						
Output Voltage	I _{OUT} = 0, T _A = +25°C	MAX6043B (0.1%)	4.0919	4.0960	4.1001	V
		MAX6043C (0.5%)	4.0755	4.0960	4.1165	
Output-Voltage Temperature Coefficient (Note 2)	T _A = -40°C to +125°C	MAX6043B_41		5	25	ppm/°C
		MAX6043C_41		10	65	
Line Regulation (Note 4)	6.1V ≤ V _{IN} ≤ 40V	T _A = +25°C		1	6	ppm/V
		T _A = -40°C to +125°C		1.5	10	
Load Regulation (Note 4)	Sourcing, 0 ≤ I _{OUT} ≤ 10mA	T _A = +25°C		19	70	ppm/mA
		T _A = -40°C to +125°C			70	
	Sinking, -0.6mA ≤ I _{OUT} ≤ 0mA	T _A = +25°C		100	900	
		T _A = -40°C to +125°C			900	
OUT Short-Circuit Current	OUT shorted to GND			60		mA
	OUT shorted to IN			-2		
Thermal Hysteresis	(Note 3)			150		ppm
Long-Term Stability	Δt = 1000hr			150		ppm
DYNAMIC CHARACTERISTICS						
Output Noise Voltage	0.1Hz to 10Hz			6.6		μV _{P-P}
	10Hz to 1kHz			12		μV _{RMS}
Turn-On Settling Time	To V _{OUT} = 0.05% of final value, C _{OUT} = 50pF			200		μs
INPUT						
Supply Voltage Range	Inferred from line regulation test		6.1		40.0	V
Quiescent Supply Current	I _{OUT} = 0	T _A = +25°C		320	490	μA
		T _A = -40°C to +125°C		380	650	

Electrical Characteristics— $V_{OUT} = +5.0V$

($V_{IN} = +15V$, $I_{OUT} = 0$, $T_A = T_{MIN}$ to T_{MAX} . Typical values are at $T_A = +25^\circ C$, unless otherwise noted.) (Note 1)

PARAMETER	CONDITIONS		MIN	TYP	MAX	UNITS
OUTPUT						
Output Voltage	$I_{OUT} = 0$, $T_A = +25^\circ C$	MAX6043B (0.1%)	4.9950	5.0000	5.0050	V
		MAX6043C (0.5%)	4.9751	5.0000	5.0250	
Output-Voltage Temperature Coefficient (Note 2)	$T_A = -40^\circ C$ to $+125^\circ C$	MAX6043B_50		5	25	ppm/ $^\circ C$
		MAX6043C_50		10	65	
Line Regulation (Note 4)	$7V \leq V_{IN} \leq 40V$	$T_A = +25^\circ C$		1	6	ppm/V
		$T_A = -40^\circ C$ to $+125^\circ C$		1.5	10	
Load Regulation (Note 4)	Sourcing, $0 \leq I_{OUT} \leq 10mA$	$T_A = +25^\circ C$		32	70	ppm/mA
		$T_A = -40^\circ C$ to $+125^\circ C$			70	
	Sinking, $-0.6mA \leq I_{OUT} \leq 0mA$	$T_A = +25^\circ C$		130	900	
		$T_A = -40^\circ C$ to $+125^\circ C$			900	
OUT Short-Circuit Current	OUT shorted to GND			60		mA
	OUT shorted to IN			-2		
Thermal Hysteresis	(Note 3)			150		ppm
Long-Term Stability	$\Delta t = 1000hr$			150		ppm
DYNAMIC CHARACTERISTICS						
Output Noise Voltage	0.1Hz to 10Hz			9.5		μV_{P-P}
	10Hz to 1kHz			15		μV_{RMS}
Turn-On Settling Time	To $V_{OUT} = 0.05\%$ of final value, $C_{OUT} = 50pF$			230		μs
INPUT						
Supply Voltage Range	Inferred from line regulation test		7.0		40.0	V
Quiescent Supply Current	$I_{OUT} = 0$	$T_A = +25^\circ C$		320	490	μA
		$T_A = -40^\circ C$ to $+125^\circ C$		380	650	

Electrical Characteristics— $V_{OUT} = +10.0V$

($V_{IN} = +15V$, $I_{OUT} = 0$, $T_A = T_{MIN}$ to T_{MAX} . Typical values are at $T_A = +25^\circ C$, unless otherwise noted.) (Note 1)

PARAMETER	CONDITIONS		MIN	TYP	MAX	UNITS
OUTPUT						
Output Voltage	$I_{OUT} = 0$, $T_A = +25^\circ C$	MAX6043B (0.1%)	9.9900	10.0000	10.0100	V
		MAX6043C (0.5%)	9.9500	10.0000	10.0500	
Output-Voltage Temperature Coefficient (Note 2)	$T_A = -40^\circ C$ to $+125^\circ C$	MAX6043B_10		5	25	ppm/ $^\circ C$
		MAX6043C_10		10	65	
Line Regulation (Note 4)	$12V \leq V_{IN} \leq 40V$	$T_A = +25^\circ C$		1	6	ppm/V
		$T_A = -40^\circ C$ to $+125^\circ C$		1.5	10	
Load Regulation (Note 4)	Sourcing, $0 \leq I_{OUT} \leq 10mA$	$T_A = +25^\circ C$		16	70	ppm/mA
		$T_A = -40^\circ C$ to $+125^\circ C$			70	
	Sinking, $-0.6mA \leq I_{OUT} \leq 0mA$	$T_A = +25^\circ C$		170	900	
		$T_A = -40^\circ C$ to $+125^\circ C$			900	
OUT Short-Circuit Current	OUT shorted to GND			60		mA
	OUT shorted to IN			-2		
Thermal Hysteresis	(Note 3)			150		ppm
Long-Term Stability	$\Delta t = 1000hr$			150		ppm
DYNAMIC CHARACTERISTICS						
Output Noise Voltage	0.1Hz to 10Hz			19		μV_{P-P}
	10Hz to 1kHz			30		μV_{RMS}
Turn-On Settling Time	To $V_{OUT} = 0.05\%$ of final value, $C_{OUT} = 50pF$			390		μs
INPUT						
Supply Voltage Range	Inferred from line regulation test		12.0		40.0	V
Quiescent Supply Current	$I_{OUT} = 0$	$T_A = +25^\circ C$		320	490	μA
		$T_A = -40^\circ C$ to $+125^\circ C$		390	650	

Note 1: All devices are 100% production tested at $T_A = +25^\circ C$ and guaranteed by design over $T_A = T_{MIN}$ to T_{MAX} as specified.

Note 2: Temperature coefficient is defined as ΔV_{OUT} divided by the temperature range.

Note 3: Thermal hysteresis defined as the change in output voltage at $T_A = +25^\circ C$ before and after cycling the device from T_{MAX} to T_{MIN} .

Note 4: Line and load regulation do not include the effect of self heating.

Typical Operating Characteristics

($V_{IN} = +5V$ for $V_{OUT} = +2.5V$, $V_{IN} = +10V$ for $V_{OUT} = +3.3V$ or $+4.096V$, $V_{IN} = +15V$ for $V_{OUT} = +5V$ or $+10V$, $I_{OUT} = 0$, $T_A = +25^\circ C$, unless otherwise noted.)

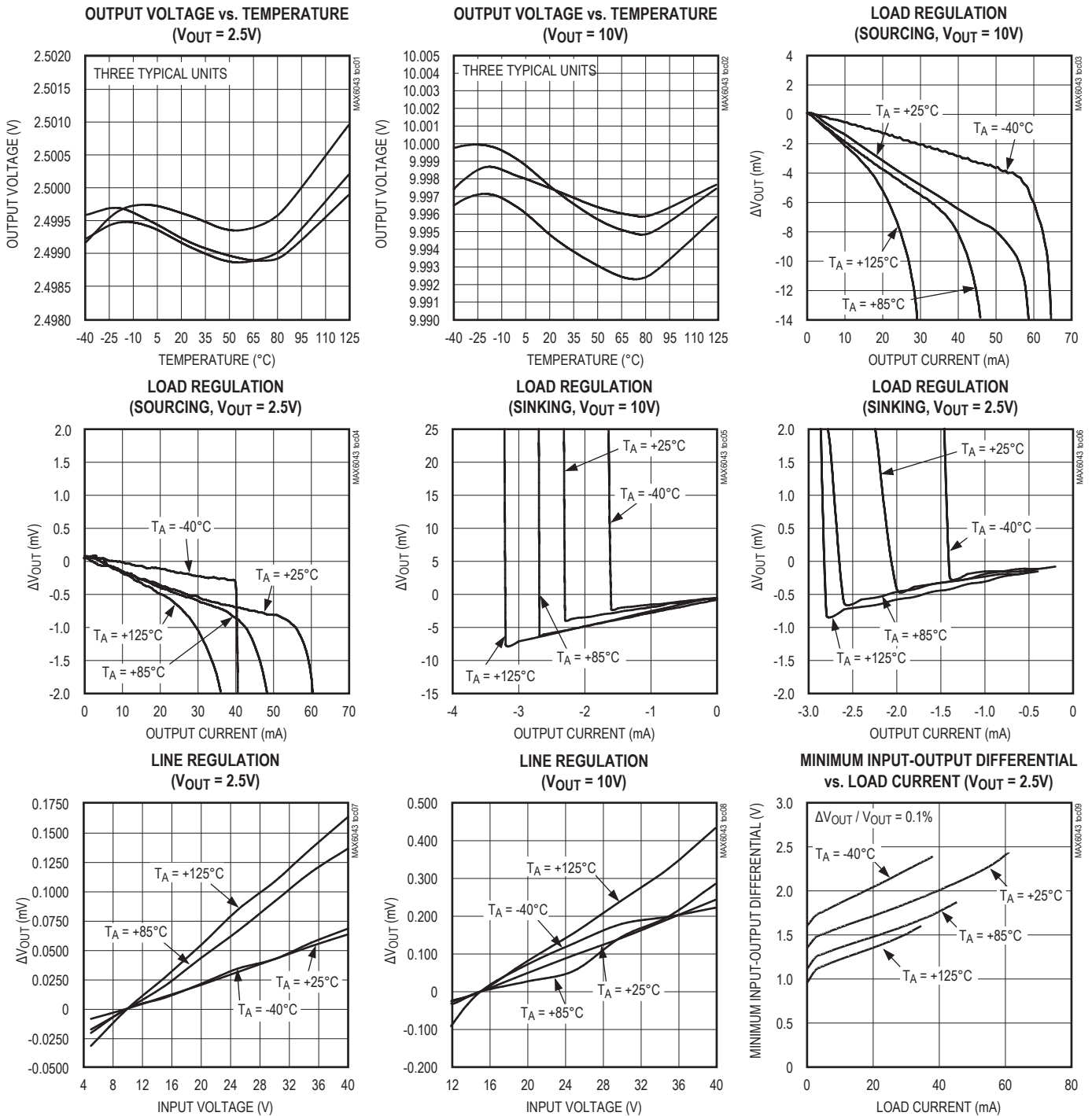

Typical Operating Characteristics (continued)

($V_{IN} = +5V$ for $V_{OUT} = +2.5V$, $V_{IN} = +10V$ for $V_{OUT} = +3.3V$ or $+4.096V$, $V_{IN} = +15V$ for $V_{OUT} = +5V$ or $+10V$, $I_{OUT} = 0$, $T_A = +25^\circ C$, unless otherwise noted.)

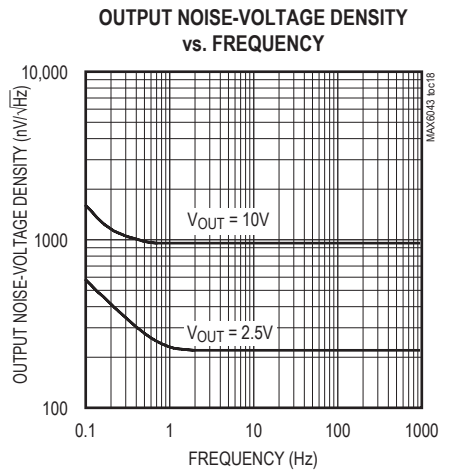
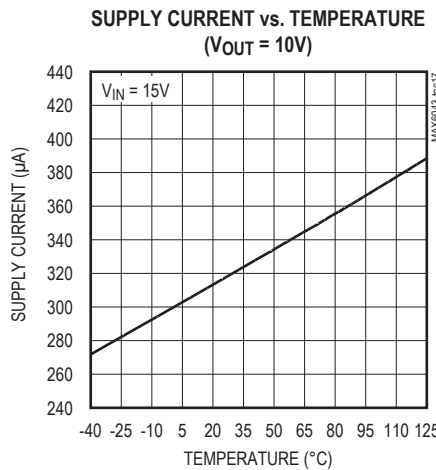
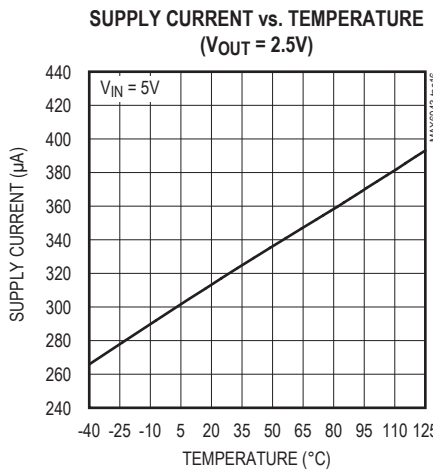
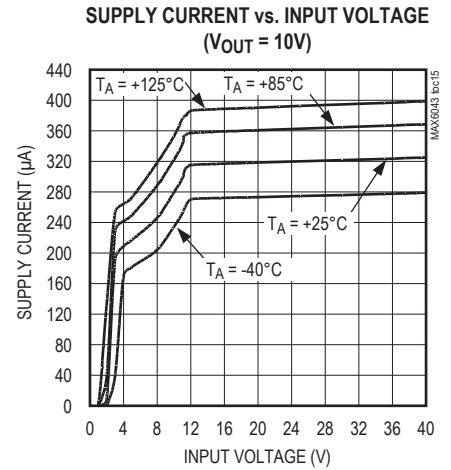
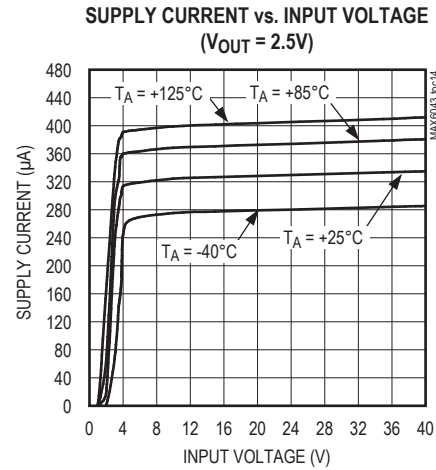
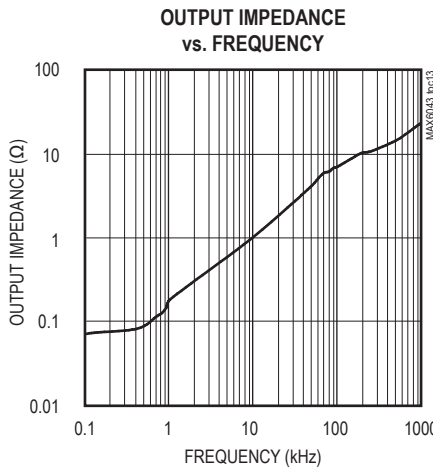
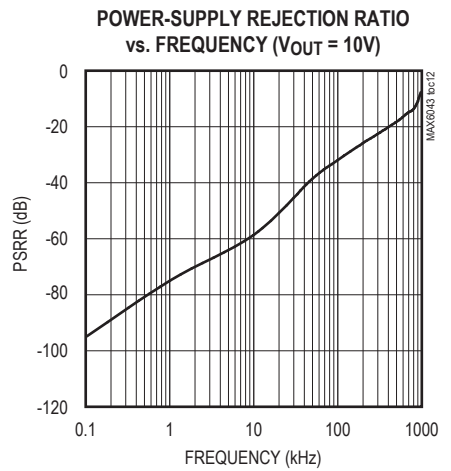
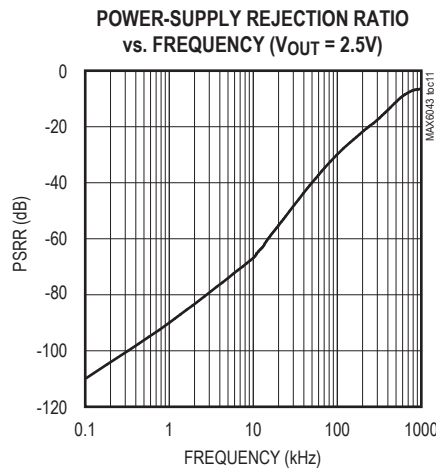
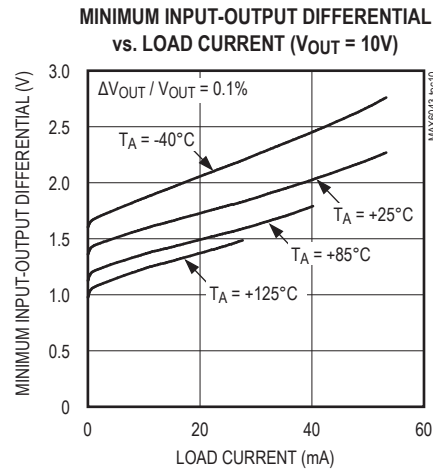

Typical Operating Characteristics (continued)

($V_{IN} = +5V$ for $V_{OUT} = +2.5V$, $V_{IN} = +10V$ for $V_{OUT} = +3.3V$ or $+4.096V$, $V_{IN} = +15V$ for $V_{OUT} = +5V$ or $+10V$, $I_{OUT} = 0$, $T_A = +25^\circ C$, unless otherwise noted.)

0.1Hz TO 10Hz OUTPUT NOISE
($V_{OUT} = 2.5V$)

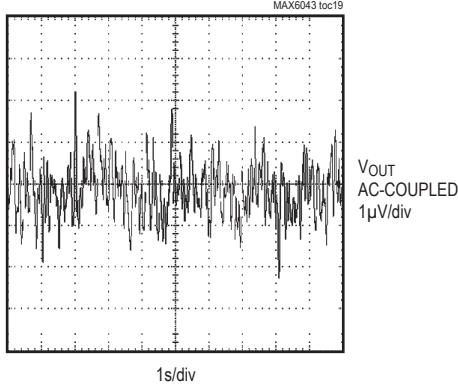

0.1Hz TO 10Hz OUTPUT NOISE
($V_{OUT} = 10V$)

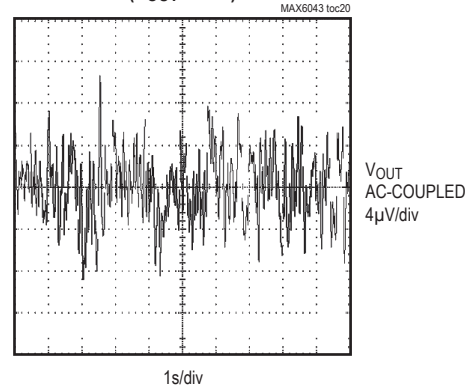

LOAD TRANSIENT
($V_{OUT} = 2.5V$)

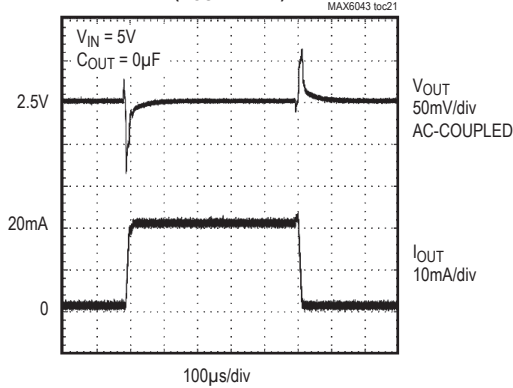

LOAD TRANSIENT
($V_{OUT} = 10V$)

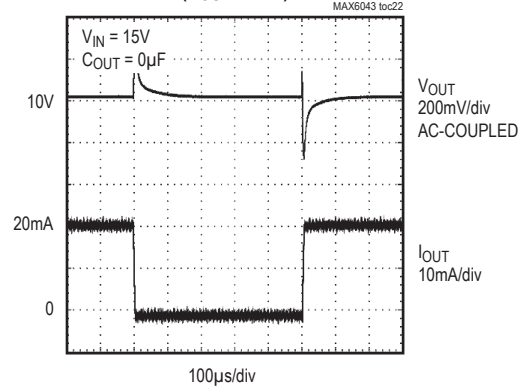

LOAD TRANSIENT
($V_{OUT} = 2.5V$)

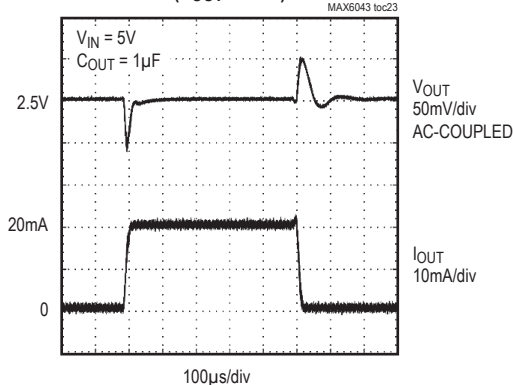

LOAD TRANSIENT
($V_{OUT} = 10V$)

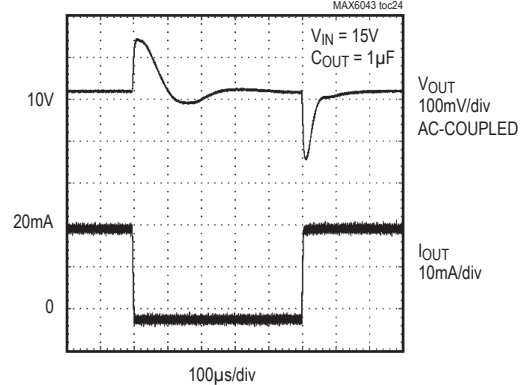

Typical Operating Characteristics (continued)

($V_{IN} = +5V$ for $V_{OUT} = +2.5V$, $V_{IN} = +10V$ for $V_{OUT} = +3.3V$ or $+4.096V$, $V_{IN} = +15V$ for $V_{OUT} = +5V$ or $+10V$, $I_{OUT} = 0$, $T_A = +25^\circ C$, unless otherwise noted.)

LOAD TRANSIENT
($V_{OUT} = 2.5V$)

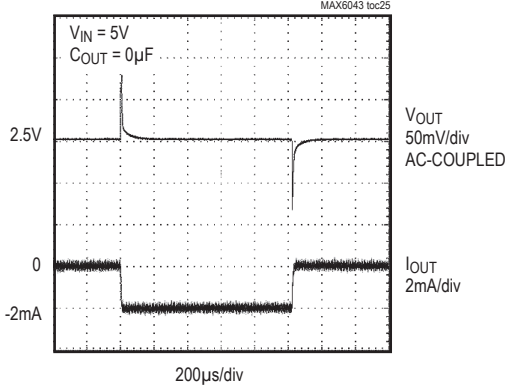

LOAD TRANSIENT
($V_{OUT} = 10V$)

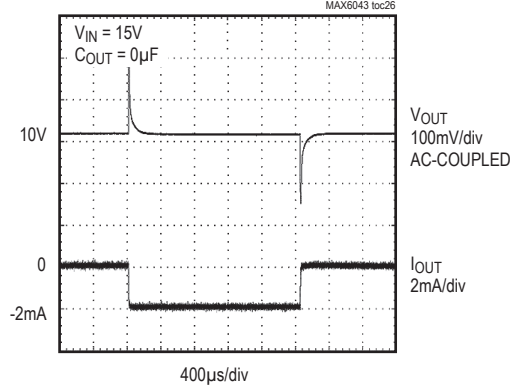

LOAD TRANSIENT
($V_{OUT} = 2.5V$)

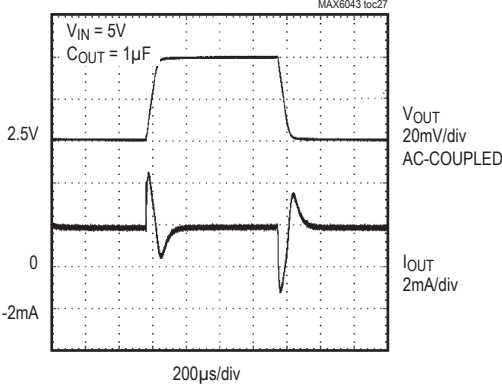

LOAD TRANSIENT
($V_{OUT} = 10V$)

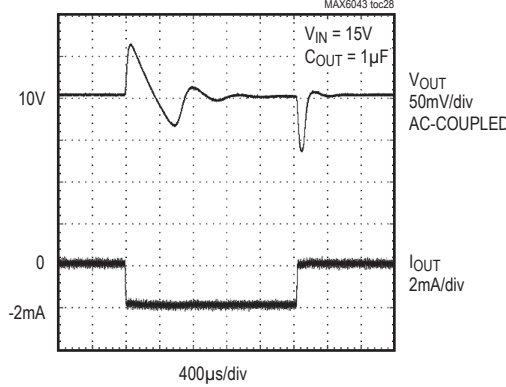

LINE TRANSIENT
($V_{OUT} = 2.5V$)

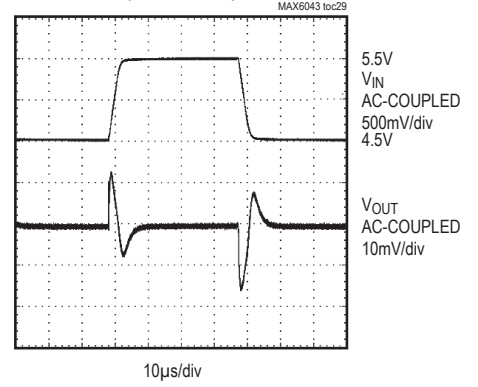

LINE TRANSIENT
($V_{OUT} = 10V$)

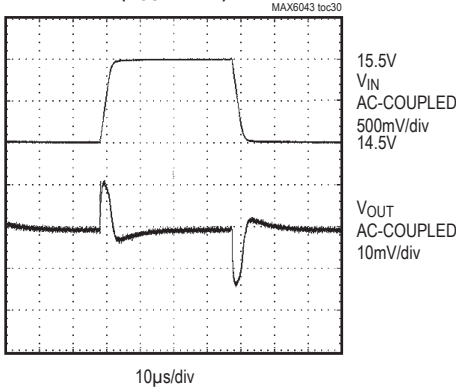

TURN-ON TRANSIENT
($V_{OUT} = 2.5V$)

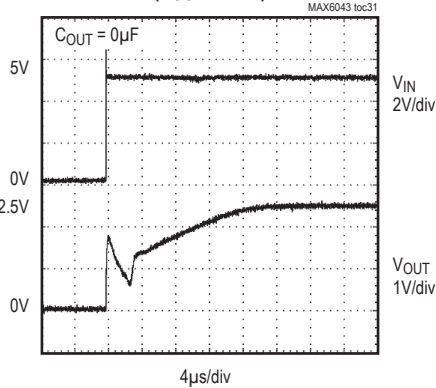

TURN-ON TRANSIENT
($V_{OUT} = 10V$)

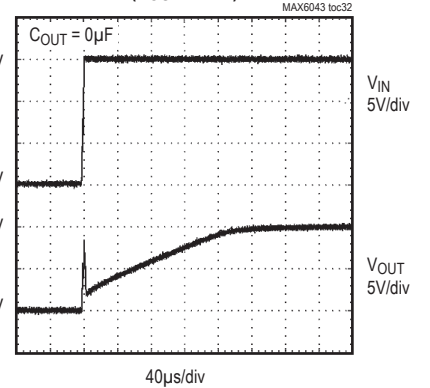

Typical Operating Characteristics (continued)

($V_{IN} = +5V$ for $V_{OUT} = +2.5V$, $V_{IN} = +10V$ for $V_{OUT} = +3.3V$ or $+4.096V$, $V_{IN} = +15V$ for $V_{OUT} = +5V$ or $+10V$, $I_{OUT} = 0$, $T_A = +25^\circ C$, unless otherwise noted.)

TURN-ON TRANSIENT
($V_{OUT} = 2.5V$)

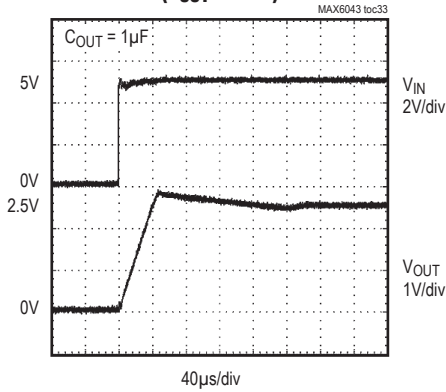

TURN-ON TRANSIENT
($V_{OUT} = 10V$)

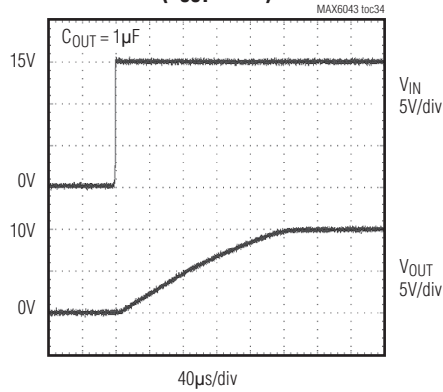

TURN-OFF TRANSIENT
($V_{OUT} = 2.5V$)

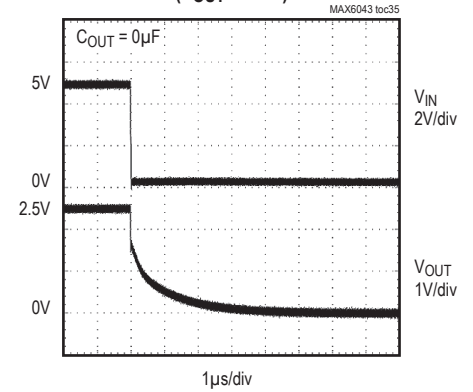

TURN-OFF TRANSIENT
($V_{OUT} = 10V$)

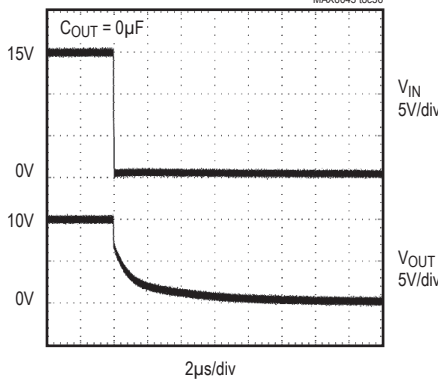

TURN-OFF TRANSIENT
($V_{OUT} = 2.5V$)

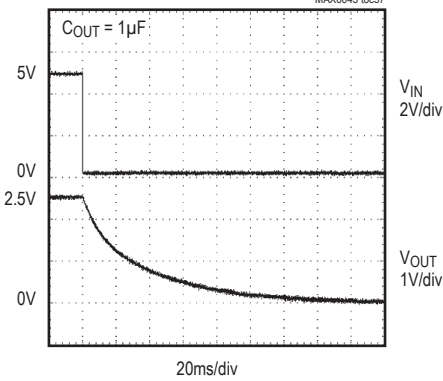

TURN-OFF TRANSIENT

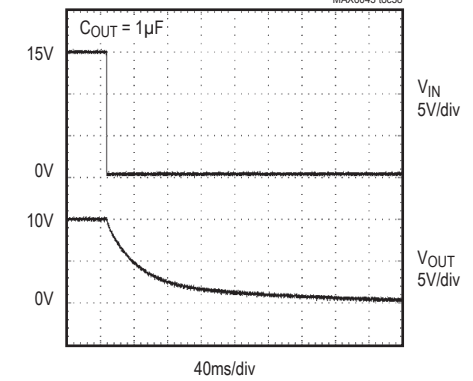

LONG-TERM DRIFT
($V_{OUT} = 2.5V$)

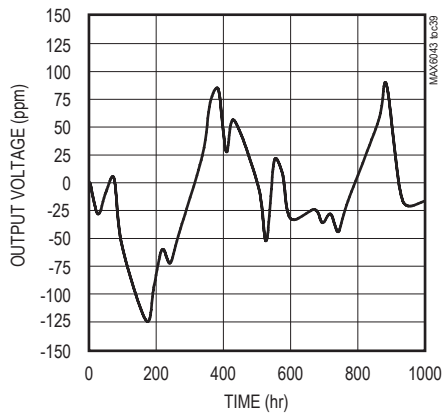

LONG-TERM DRIFT
($V_{OUT} = 10V$)

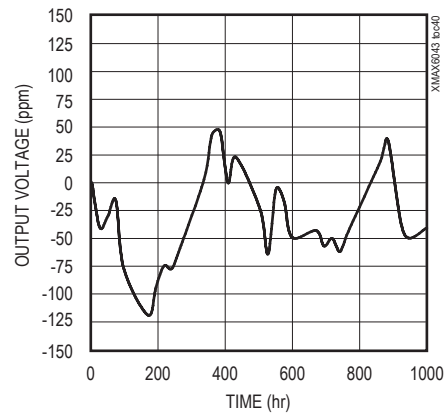

Pin Description

PIN	NAME	FUNCTION
1, 3	I.C.	Internally Connected. Do not connect externally.
2	GND	Ground
4	IN	Positive Power-Supply Input
5	OUTF	Voltage-Reference Force Output. Connect OUTF to OUTS as close to the device as possible. OUTF and OUTS do not require a bypass capacitor for stability.
6	OUTS	Voltage-Reference Sense Input

Applications Information

Bypassing/Output Capacitance

For the best line-transient performance, decouple the input with a 0.1 μ F ceramic capacitor as shown in the *Typical Operating Circuit*. Place the capacitor as close to IN as possible. When transient performance is less important, no capacitor is necessary.

The MAX6043 does not require an output capacitor for stability and is stable with capacitive loads up to 100 μ F. In applications where the load or the supply can experience step changes, a larger output capacitor reduces the amount of overshoot (undershoot) and improves the circuit's transient response. Place output capacitors as close to the device as possible for best performance.

Supply Current

The MAX6043 consumes 320 μ A of quiescent supply current. This improved efficiency reduces power dissipation and extends battery life.

Thermal Hysteresis

Thermal hysteresis is the change in the output voltage at $T_A = +25^\circ\text{C}$ before and after the device is cycled over its entire operating temperature range. Hysteresis is caused by differential package stress appearing across the band-gap core transistors. The typical thermal hysteresis value is 150ppm.

Turn-On Time

The MAX6043 typically turns on and settles to within 0.05% of the preset output voltage in 150 μ s.

Short-Circuited Outputs

The MAX6043 features a short-circuit-protected output. Internal circuitry limits the output current to 60mA when short-circuiting the output.

Temperature Coefficient vs. Operating Temperature Range for a 1 LSB Maximum Error

In a data converter application, the reference voltage of the converter must stay within a certain limit to keep the error in the data converter smaller than the resolution limit through the operating temperature range. Figure 1 shows the maximum allowable reference-voltage temperature coefficient to keep the conversion error to less than 1 LSB, as a function of the operating temperature range ($T_{MAX} - T_{MIN}$) with the converter resolution as a parameter. The graph assumes the reference-voltage temperature coefficient as the only parameter affecting accuracy.

In reality, the absolute static accuracy of a data converter is dependent on the combination of many parameters such as integral nonlinearity, differential nonlinearity, offset error, gain error, as well as voltage-reference changes.

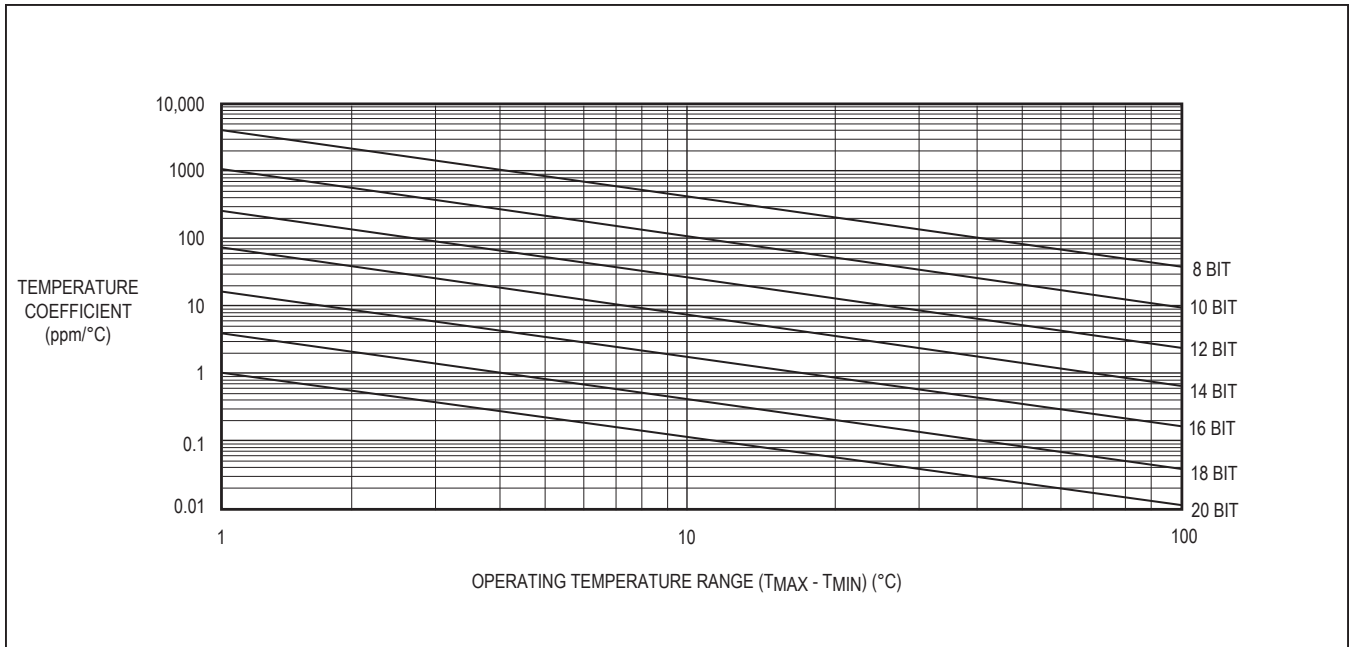
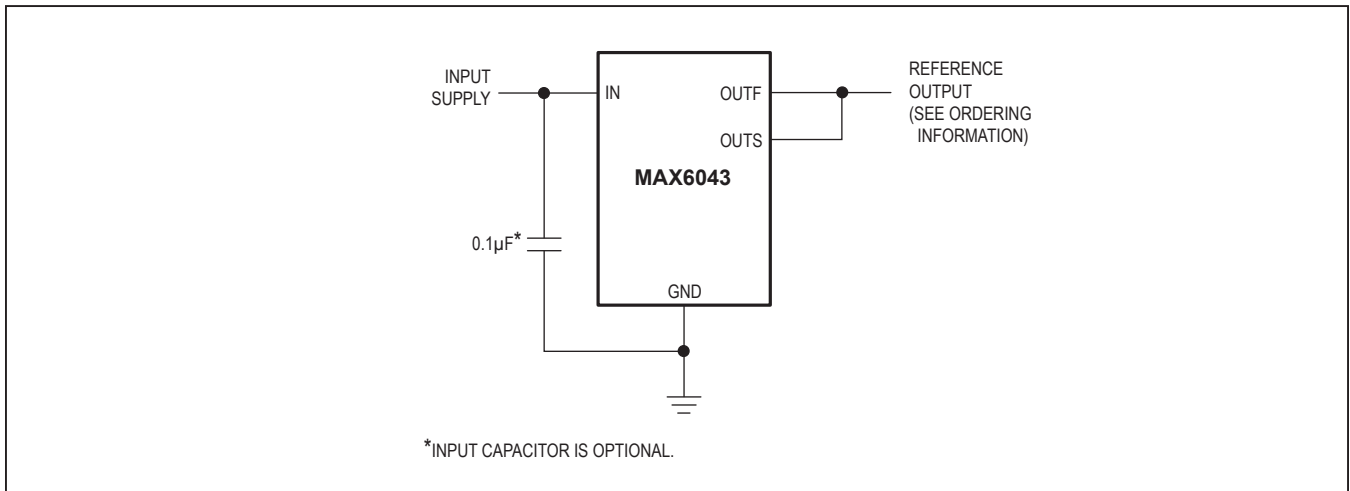

Figure 1. Temperature Coefficient vs. Operating Temperature Range for a 1 LSB Maximum Error

Typical Operating Circuit



Ordering Information (continued)

PART	OUTPUT VOLTAGE (V)	TEMPCO (PPM/°C)	INITIAL ACCURACY (%)	TOP MARK
MAX6043CAUT41-T	4.096	65	0.50	ABDV
MAX6043BAUT50-T	5.000	20	0.10	ABDW
MAX6043CAUT50-T	5.000	65	0.50	ABDX
MAX6043BAUT10-T	10.000	20	0.10	ABDY
MAX6043CAUT10-T	10.000	65	0.50	ABDZ
MAX6043BAUT25+T	2.500	20	0.10	+ABDQ
MAX6043BAUT33+T	3.300	20	0.10	+ABDS
MAX6043BAUT41+T	4.096	20	0.10	+ABDU
MAX6043BAUT50+T	5.000	20	0.10	+ABDW
MAX6043BAUT10+T	10.000	20	0.10	+ABDY
MAX6043CAUT25+T	2.500	65	0.50	+ABDR
MAX6043CAUT33+T	3.300	65	0.50	+ABDT
MAX6043CAUT41+T	4.096	65	0.50	+ABDV
MAX6043CAUT50+T	5.000	65	0.50	+ABDX
MAX6043CAUT10+T	10.000	65	0.50	+ABDZ

#Denotes an RoHS-compliant device that may include lead that is exempt under the RoHS requirements.

T = Tape and reel.

Chip Information

PROCESS: BICMOS

Revision History

REVISION NUMBER	REVISION DATE	DESCRIPTION	PAGES CHANGED
0	11/03	Initial release	—
1	5/04	Added future product information, updated the <i>Electrical Characteristics</i> and <i>Typical Operating Characteristics</i> .	1–6, 11, 12
2	8/12	Updated the <i>Ordering Information/Selector Guide</i> , <i>Absolute Maximum Ratings</i> , and the <i>Package Information</i> sections.	1, 14, 15
3	1/19	Updated <i>Ordering Information</i> , <i>Absolute Maximum Ratings</i> , added <i>Package Information</i> section	1, 2, 14
4	3/19	Updated <i>Ordering Information</i>	15
5	1/20	Updated <i>Ordering Information</i>	15
6	7/21	Updated <i>Ordering Information</i>	1, 15
7	11/21	Updated <i>Ordering Information</i> and <i>Electrical Characteristics</i> table	1, 3–7, 15



Information furnished by Analog Devices is believed to be accurate and reliable. However, no responsibility is assumed by Analog Devices for its use, nor for any infringements of patents or other rights of third parties that may result from its use. Specifications subject to change without notice. No license is granted by implication or otherwise under any patent or patent rights of Analog Devices. Trademarks and registered trademarks are the property of their respective owners.

Looking for pricing, stock, or lifecycle information?

Click below to explore more details on WIN SOURCE:

 [View MAX6043AAUT50#TG16 on WIN SOURCE](#)

 [Maxim Integrated](#) Information

Optimize Your Supply Chain with WIN SOURCE Solutions

-  Global Sourcing Solution
-  Obsolete Management
-  Cost Control Management
-  Shortage Management
-  Alternative Solution
-  Excess Inventory Management