

# Film Capacitors

## Metallized Polypropylene Film Capacitors (MKP)

**Series/Type:** B32674 ... B32678

**Date:** June 2018

© EPCOS AG 2018. Reproduction, publication and dissemination of this publication, enclosures hereto and the information contained therein without EPCOS' prior express consent is prohibited.

EPCOS AG is a TDK Group Company.

**MKP DC link – high power series****Typical applications**

- Frequency converters
- Industrial and high-end power supplies
- Solar inverters

**Climatic**

- Max. operating temperature: 105 °C (case)
- Climatic category (IEC 60068-1:2013):  
40/105/56

**Construction**

- Dielectric: Polypropylene (MKP)
- Plastic case (UL 94 V-0)
- Epoxy resin sealing (UL 94 V-0)

**Features**

- Capacitance value up to 270  $\mu$ F
- High CV product, compact
- Good self-healing properties
- Over-voltage capability
- Low losses with high current capability
- High reliability
- Long useful life
- AEC-Q200D compliant

**Terminals**

- Parallel wire leads, lead-free tinned
- 2-pin, 4-pin and 12-pin versions
- Standard lead lengths: 6 – 1 mm

**Marking**

Manufacturer's logo and lot number,  
date code, rated capacitance (coded),  
capacitance tolerance (code letter),  
rated DC voltage

**Delivery mode**

Bulk (untaped, lead length 6 – 1 mm)



## Dimensional drawings

Dimensions in mm

| Number of wires | Lead spacing $e \pm 0.4$ | Lead diameter $d_1 \pm 0.05$ | Type    |
|-----------------|--------------------------|------------------------------|---------|
| 2-pin           | 27.5                     | 0.8                          | B32674D |
| 2-pin           | 37.5                     | 1.0                          | B32676T |
| 4-pin           | 37.5                     | 1.2                          | B32676G |
| 4-pin           | 37.5                     | 1.2                          | B32676T |
| 4-pin           | 52.5                     | 1.2                          | B32678G |
| 4-pin           | 52.5                     | 1.2                          | B32678T |
| 12-pin          | 52.5                     | 1.2                          | B32678J |

## Dimensional drawings 2-pin versions

### B32674D



|                            |      |
|----------------------------|------|
| Lead spacing $e \pm 0.4$ : | 27.5 |
| Lead diameter $d_1$ :      | 0.8  |

(Dimensions in mm)

### B32676T (low profile)

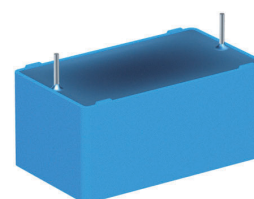

|                            |      |
|----------------------------|------|
| Lead spacing $e \pm 0.4$ : | 37.5 |
| Lead diameter $d_1$ :      | 1.0  |

(Dimensions in mm)



**B32674 ... B32678**

**MKP DC link – high power series**

**Dimensional drawings 4-pin versions**

**B32676G, B32678G**



|                            | B32676G | B32678G |
|----------------------------|---------|---------|
| Lead spacing $e \pm 0.4$ : | 37.5    | 52.5    |
| Lead diameter $d_1$ :      | 1.2     | 1.2     |

(Dimensions in mm)

**B32676T, B32678T (low profile)**

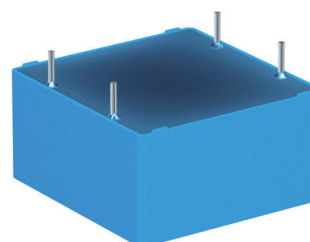

|                            | B32676T | B32678T |
|----------------------------|---------|---------|
| Lead spacing $e \pm 0.4$ : | 37.5    | 52.5    |
| Lead diameter $d_1$ :      | 1.2     | 1.2     |

(Dimensions in mm)

**Dimensional drawing 12-pin version**

**B32678J**

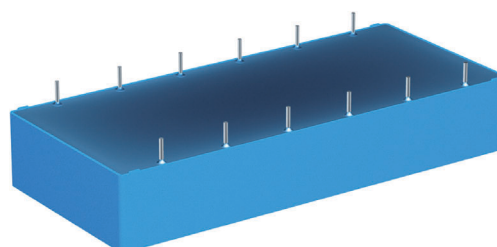

|                            |      |
|----------------------------|------|
| Lead spacing $e \pm 0.4$ : | 52.5 |
| Lead diameter $d_1$ :      | 1.2  |

(Dimensions in mm)



Overview of available types

| Lead spacing          | 27.5 mm |     |     |     |     | 37.5 mm |     |     |     |     |
|-----------------------|---------|-----|-----|-----|-----|---------|-----|-----|-----|-----|
| Type                  | B32674  |     |     |     |     | B32676  |     |     |     |     |
| Page                  | 7       |     |     |     |     | 9       |     |     |     |     |
| V <sub>R</sub> (V DC) | 300     | 450 | 630 | 750 | 875 | 300     | 450 | 630 | 750 | 875 |
| C <sub>R</sub> (μF)   |         |     |     |     |     |         |     |     |     |     |
| 0.47                  |         |     |     |     |     |         |     |     |     |     |
| 0.68                  |         |     |     |     |     |         |     |     |     |     |
| 1.0                   |         |     |     |     |     |         |     |     |     |     |
| 1.5                   |         |     |     |     |     |         |     |     |     |     |
| 2.0                   |         |     |     |     |     |         |     |     |     |     |
| 2.2                   |         |     |     |     |     |         |     |     |     |     |
| 2.7                   |         |     |     |     |     |         |     |     |     |     |
| 3.0                   |         |     |     |     |     |         |     |     |     |     |
| 3.3                   |         |     |     |     |     |         |     |     |     |     |
| 3.5                   |         |     |     |     |     |         |     |     |     |     |
| 4.0                   |         |     |     |     |     |         |     |     |     |     |
| 4.7                   |         |     |     |     |     |         |     |     |     |     |
| 5.0                   |         |     |     |     |     |         |     |     |     |     |
| 5.6                   |         |     |     |     |     |         |     |     |     |     |
| 6.0                   |         |     |     |     |     |         |     |     |     |     |
| 6.2                   |         |     |     |     |     |         |     |     |     |     |
| 6.8                   |         |     |     |     |     |         |     |     |     |     |
| 7.5                   |         |     |     |     |     |         |     |     |     |     |
| 8.0                   |         |     |     |     |     |         |     |     |     |     |
| 8.2                   |         |     |     |     |     |         |     |     |     |     |
| 9.0                   |         |     |     |     |     |         |     |     |     |     |
| 10                    |         |     |     |     |     |         |     |     |     |     |
| 12                    |         |     |     |     |     |         |     |     |     |     |
| 13                    |         |     |     |     |     |         |     |     |     |     |
| 14                    |         |     |     |     |     |         |     |     |     |     |
| 15                    |         |     |     |     |     |         |     |     |     |     |
| 20                    |         |     |     |     |     |         |     |     |     |     |
| 22                    |         |     |     |     |     |         |     |     |     |     |
| 25                    |         |     |     |     |     |         |     |     |     |     |
| 30                    |         |     |     |     |     |         |     |     |     |     |
| 35                    |         |     |     |     |     |         |     |     |     |     |

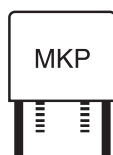

B32674 ... B32678

MKP DC link – high power series

### Overview of available types

|                  |         |     |     |     |     |
|------------------|---------|-----|-----|-----|-----|
| Lead spacing     | 52.5 mm |     |     |     |     |
| Type             | B32678  |     |     |     |     |
| Page             | 11      |     |     |     |     |
| $V_R$ (V DC)     | 300     | 450 | 630 | 750 | 875 |
| $C_R$ ( $\mu$ F) |         |     |     |     |     |
| 7.0              |         |     |     |     |     |
| 9.0              |         |     |     |     |     |
| 13               |         |     |     |     |     |
| 15               |         |     |     |     |     |
| 20               |         |     |     |     |     |
| 22               |         |     |     |     |     |
| 24               |         |     |     |     |     |
| 25               |         |     |     |     |     |
| 28               |         |     |     |     |     |
| 30               |         |     |     |     |     |
| 35               |         |     |     |     |     |
| 38               |         |     |     |     |     |
| 40               |         |     |     |     |     |
| 45               |         |     |     |     |     |
| 47               |         |     |     |     |     |
| 60               |         |     |     |     |     |
| 65               |         |     |     |     |     |
| 80               |         |     |     |     |     |
| 85               |         |     |     |     |     |
| 100              |         |     |     |     |     |
| 120              |         |     |     |     |     |
| 180              |         |     |     |     |     |
| 270              |         |     |     |     |     |

**Ordering codes and packing units (lead spacing 27.5 mm)**

| $C_R^{1)}$<br>$\mu\text{F}$   | Max. dimensions<br>$w \times h \times l$<br>mm | $P_1$<br>mm | Ordering code<br>(composition see<br>below) | $I_{\text{RMS,max}}^{2)}$<br>70 °C<br>10 kHz<br>A | $\text{ESR}_{\text{typ}}$<br>70 °C<br>10 kHz<br>m $\Omega$ | $\text{ESL}_{\text{typ}}^{3)}$<br>nH | $\tan \delta$<br>1 kHz<br>$10^{-3}$ | $\tan \delta$<br>10 kHz<br>$10^{-3}$ | pcs./<br>MOQ |
|---|--|-------------|---|---|--|--------------------------------------|-------------------------------------|--------------------------------------|--------------|
| <b><math>V_{\text{R,85 °C}} = 300 \text{ V DC}, V_{\text{op,70 °C}} = 450 \text{ V DC}</math></b> |  |             |   |   |  |                                      |                                     |                                      |              |
| 2.2   | 11.0 × 19.0 × 31.5                             | –           | B32674D3225+000                             | 5.0   | 18.1   | 16.0                                 | 0.7                                 | 4.1                                  | 1280         |
| 3.3   | 12.5 × 21.5 × 31.5                             | –           | B32674D3335+000                             | 7.0   | 12.2   | 19.0                                 | 0.7                                 | 4.1                                  | 1120         |
| 4.7   | 14.0 × 24.5 × 31.5                             | –           | B32674D3475+000                             | 8.5   | 8.9  | 21.0                                 | 0.7                                 | 4.2                                  | 1040         |
| 5.0   | 15.0 × 24.5 × 31.5                             | –           | B32674D3505+000                             | 9.0   | 8.4  | 21.0                                 | 0.7                                 | 4.2                                  | 960          |
| 6.8   | 18.0 × 27.5 × 31.5                             | –           | B32674D3685+000                             | 11.5  | 6.3  | 24.0                                 | 0.7                                 | 4.4                                  | 800          |
| 8.0   | 16.0 × 32.0 × 31.5                             | –           | B32674D3805+000                             | 12.5  | 5.6  | 27.0                                 | 0.7                                 | 4.5                                  | 880          |
| 8.2   | 18.0 × 33.0 × 31.5                             | –           | B32674D3825+000                             | 13.0  | 5.5  | 27.0                                 | 0.7                                 | 4.5                                  | 800          |
| 10.0  | 21.0 × 31.0 × 31.5                             | –           | B32674D3106+000                             | 14.5  | 4.6  | 27.0                                 | 0.8                                 | 4.6                                  | 720          |
| 12.0  | 22.0 × 36.5 × 31.5                             | –           | B32674D3126+000                             | 17.0  | 4.0  | 31.0                                 | 0.8                                 | 4.9                                  | 640          |
| <b><math>V_{\text{R,85 °C}} = 450 \text{ V DC}, V_{\text{op,70 °C}} = 630 \text{ V DC}</math></b> |  |             |   |   |  |                                      |                                     |                                      |              |
| 1.5   | 11.0 × 19.0 × 31.5                             | –           | B32674D4155+000                             | 4.5   | 22.1   | 16.0                                 | 0.6                                 | 3.3                                  | 1280         |
| 2.2   | 12.5 × 21.5 × 31.5                             | –           | B32674D4225+000                             | 6.0   | 14.9   | 19.0                                 | 0.6                                 | 3.3                                  | 1120         |
| 3.3   | 15.0 × 24.5 × 31.5                             | –           | B32674D4335+000                             | 8.0   | 10.3   | 22.0                                 | 0.6                                 | 3.4                                  | 960          |
| 4.7   | 18.0 × 27.5 × 31.5                             | –           | B32674D4475+000                             | 10.5  | 7.5  | 24.0                                 | 0.6                                 | 3.5                                  | 800          |
| 5.0   | 16.0 × 32.0 × 31.5                             | –           | B32674D4505+000                             | 11.0  | 7.1  | 28.0                                 | 0.7                                 | 3.6                                  | 880          |
| 5.6   | 18.0 × 33.0 × 31.5                             | –           | B32674D4565+000                             | 12.0  | 6.3  | 29.0                                 | 0.7                                 | 3.6                                  | 800          |
| 6.0   | 21.0 × 31.0 × 31.5                             | –           | B32674D4605+000                             | 13.0  | 5.9  | 28.0                                 | 0.7                                 | 3.6                                  | 720          |
| 6.8   | 22.0 × 36.5 × 31.5                             | –           | B32674D4685+000                             | 14.5  | 5.4  | 29.0                                 | 0.7                                 | 3.7                                  | 640          |
| 7.5   | 22.0 × 36.5 × 31.5                             | –           | B32674D4755+000                             | 15.0  | 5.0  | 32.0                                 | 0.7                                 | 3.8                                  | 640          |
| <b><math>V_{\text{R,85 °C}} = 630 \text{ V DC}, V_{\text{op,70 °C}} = 800 \text{ V DC}</math></b> |  |             |   |   |  |                                      |                                     |                                      |              |
| 1.0   | 11.0 × 19.0 × 31.5                             | –           | B32674D6105+000                             | 4.0   | 26.1   | 17.0                                 | 0.6                                 | 2.7                                  | 1280         |
| 1.5   | 12.5 × 21.5 × 31.5                             | –           | B32674D6155+000                             | 5.5   | 17.9   | 19.0                                 | 0.6                                 | 2.7                                  | 1120         |
| 2.2   | 15.0 × 24.5 × 31.5                             | –           | B32674D6225+000                             | 7.5   | 12.4   | 21.0                                 | 0.6                                 | 2.7                                  | 960          |
| 3.3   | 16.0 × 32.0 × 31.5                             | –           | B32674D6335+000                             | 10.0  | 8.5  | 28.0                                 | 0.6                                 | 2.8                                  | 880          |
| 4.7   | 22.0 × 36.5 × 31.5                             | –           | B32674D6475+000                             | 13.5  | 6.0  | 31.0                                 | 0.6                                 | 3.0                                  | 640          |
| 5.0   | 22.0 × 36.5 × 31.5                             | –           | B32674D6505+000                             | 14.5  | 5.8  | 31.0                                 | 0.6                                 | 3.0                                  | 640          |

MOQ = Minimum Order Quantity, consisting of 4 packing units.  
Intermediate capacitance values are available on request.

**Composition of ordering code**

+ = Capacitance tolerance code:

K =  $\pm 10\%$

J =  $\pm 5\%$

1) Capacitance value measured at 1 kHz

2) Max. ripple current  $I_{\text{RMS}}$  at 70 °C at 10 kHz for a  $\Delta T \leq 20$  °C when  $\Delta \text{ESR}_{\text{typ}} \leq \pm 5\%$

3) ESL value measured at resonance frequency (see specific graphs of Z versus frequency)

**B32674**
**MKP DC link – high power series**
**Ordering codes and packing units (lead spacing 27.5 mm)**

| $C_R^{4)}$   | Max. dimensions<br>$w \times h \times l$ | $P_1$ | Ordering code<br>(composition see<br>below) | $I_{RMS,max}^{5)}$<br>70 °C<br>10 kHz<br>A | $ESR_{typ}$<br>70 °C<br>10 kHz<br>mΩ | $ESL_{typ}^{6)}$<br>nH | $\tan \delta$<br>1 kHz<br>$10^{-3}$ | $\tan \delta$<br>10 kHz<br>$10^{-3}$ | pcs./<br>MOQ |
|--|--|-------|---|--|--------------------------------------|------------------------|-------------------------------------|--------------------------------------|--------------|
| $V_{R,85\text{ °C}} = 750\text{ V DC}, V_{op,70\text{ °C}} = 900\text{ V DC}$  |  |       |   |  |                                      |                        |                                     |                                      |              |
| 0.68   | 11.0 × 19.0 × 31.5                       | –     | B32674D1684+000                             | 3.5  | 34.7                                 | 17.0                   | 0.5                                 | 2.4                                  | 1280         |
| 1.0  | 12.5 × 21.5 × 31.5                       | –     | B32674D1105+000                             | 4.5  | 24.2                                 | 18.0                   | 0.5                                 | 2.5                                  | 1120         |
| 1.5  | 14.0 × 24.5 × 31.5                       | –     | B32674D1155+000                             | 6.5  | 16.3                                 | 22.0                   | 0.6                                 | 2.5                                  | 1040         |
| 2.2  | 18.0 × 27.5 × 31.5                       | –     | B32674D1225+000                             | 8.5  | 11.3                                 | 24.0                   | 0.6                                 | 2.5                                  | 800          |
| 3.3  | 21.0 × 31.0 × 31.5                       | –     | B32674D1335+000                             | 11.0                                       | 7.9                                  | 28.0                   | 0.6                                 | 2.6                                  | 720          |
| 4.0  | 22.0 × 36.5 × 31.5                       | –     | B32674D1405+000                             | 13.0                                       | 6.7                                  | 32.0                   | 0.6                                 | 2.7                                  | 640          |
| $V_{R,85\text{ °C}} = 875\text{ V DC}, V_{op,70\text{ °C}} = 1050\text{ V DC}$ |  |       |   |  |                                      |                        |                                     |                                      |              |
| 0.47   | 11.0 × 19.0 × 31.5                       | –     | B32674D8474+000                             | 3.0  | 45.2                                 | 16.0                   | 0.5                                 | 2.2                                  | 1280         |
| 0.68   | 11.0 × 21.0 × 31.5                       | –     | B32674D8684+000                             | 4.0  | 31.5                                 | 19.0                   | 0.5                                 | 2.2                                  | 1280         |
| 1.0  | 13.5 × 23.0 × 31.5                       | –     | B32674D8105+000                             | 5.0  | 22.2                                 | 20.0                   | 0.5                                 | 2.2                                  | 1040         |
| 1.5  | 18.0 × 27.5 × 31.5                       | –     | B32674D8155+000                             | 7.5  | 14.7                                 | 23.0                   | 0.5                                 | 2.2                                  | 800          |
| 2.2  | 18.0 × 33.0 × 31.5                       | –     | B32674D8225+000                             | 9.5  | 10.3                                 | 29.0                   | 0.5                                 | 2.3                                  | 800          |
| 3.0  | 22.0 × 36.5 × 31.5                       | –     | B32674D8305+000                             | 12.0                                       | 7.8                                  | 31.0                   | 0.5                                 | 2.4                                  | 640          |

MOQ = Minimum Order Quantity, consisting of 4 packing units.

Intermediate capacitance values are available on request.

**Composition of ordering code**

+ = Capacitance tolerance code:

K = ±10%

J = ±5%

4) Capacitance value measured at 1 kHz

5) Max. ripple current  $I_{RMS}$  at 70 °C at 10 kHz for a  $\Delta T \leq 20\text{ °C}$  when  $\Delta ESR_{typ} \leq \pm 5\%$

6) ESL value measured at resonance frequency (see specific graphs of Z versus frequency)

**Ordering codes and packing units (lead spacing 37.5 mm)**

| $C_R^{1)}$<br>$\mu\text{F}$   | Max. dimensions<br>$w \times h \times l$<br>mm | $P_1$<br>mm | Ordering code<br>(composition see<br>below) | $I_{\text{RMS,max}}^{2)}$<br>70 °C<br>10 kHz<br>A | $\text{ESR}_{\text{typ}}$<br>70 °C<br>10 kHz<br>m $\Omega$ | $\text{ESL}_{\text{typ}}^{3)}$<br>nH | $\tan \delta$<br>1 kHz<br>$10^{-3}$ | $\tan \delta$<br>10 kHz<br>$10^{-3}$ | pcs./<br>MOQ |
|---|--|-------------|---|---|--|--------------------------------------|-------------------------------------|--------------------------------------|--------------|
| <b><math>V_{\text{R,85 °C}} = 300 \text{ V DC}, V_{\text{op,70 °C}} = 450 \text{ V DC}</math></b> |  |             |   |   |  |                                      |                                     |                                      |              |
| 6.2   | 24.0 × 15.0 × 41.5                             | —           | B32676T3625+000                             | 8.0   | 12.6   | 18.0                                 | 1.1                                 | 8.2                                  | 1040         |
| 9.0   | 24.0 × 19.0 × 41.5                             | —           | B32676T3905+000                             | 10.0  | 9.1  | 19.0                                 | 1.1                                 | 8.3                                  | 780          |
| 15.0  | 20.0 × 39.5 × 42.0                             | 10.2        | B32676G3156+000                             | 16.0  | 5.4  | 10.0                                 | 1.1                                 | 8.3                                  | 640          |
| 20.0  | 28.0 × 37.0 × 42.0                             | 10.2        | B32676G3206+000                             | 20.0  | 4.0  | 11.0                                 | 1.1                                 | 8.4                                  | 440          |
| 20.0  | 43.0 × 22.0 × 41.5                             | 20.3        | B32676T3206K000                             | 19.5  | 4.0  | 13.0                                 | 1.1                                 | 8.3                                  | 280          |
| 22.0  | 28.0 × 42.5 × 42.0                             | 10.2        | B32676G3226+000                             | 21.5  | 3.8  | 11.0                                 | 1.2                                 | 8.5                                  | 440          |
| 25.0  | 28.0 × 42.5 × 42.0                             | 10.2        | B32676G3256+000                             | 22.5  | 3.4  | 12.0                                 | 1.2                                 | 8.6                                  | 440          |
| 30.0  | 30.0 × 45.0 × 42.0                             | 20.3        | B32676G3306+000                             | 26.0  | 2.8  | 12.0                                 | 1.2                                 | 8.7                                  | 400          |
| 35.0  | 33.0 × 48.0 × 42.0                             | 20.3        | B32676G3356+000                             | 29.5  | 2.5  | 13.0                                 | 1.2                                 | 8.8                                  | 180          |
| <b><math>V_{\text{R,85 °C}} = 450 \text{ V DC}, V_{\text{op,70 °C}} = 630 \text{ V DC}</math></b> |  |             |   |   |  |                                      |                                     |                                      |              |
| 4.0   | 24.0 × 15.0 × 41.5                             | —           | B32676T4405+000                             | 7.0   | 15.5   | 19.0                                 | 1.0                                 | 6.6                                  | 1040         |
| 4.7   | 24.0 × 19.0 × 41.5                             | —           | B32676T4475+000                             | 8.0   | 13.2   | 18.0                                 | 1.0                                 | 6.6                                  | 780          |
| 8.2   | 20.0 × 39.5 × 42.0                             | 10.2        | B32676G4825+000                             | 13.5  | 7.8  | 9.0                                  | 1.0                                 | 6.7                                  | 640          |
| 10.0  | 20.0 × 39.5 × 42.0                             | 10.2        | B32676G4106+000                             | 14.5  | 6.4  | 11.0                                 | 1.0                                 | 6.7                                  | 640          |
| 13.0  | 43.0 × 22.0 × 41.5                             | 20.3        | B32676T4136K000                             | 17.5  | 5.0  | 13.0                                 | 1.0                                 | 6.6                                  | 280          |
| 15.0  | 28.0 × 42.5 × 42.0                             | 10.2        | B32676G4156+000                             | 20.0  | 4.4  | 11.0                                 | 1.0                                 | 6.8                                  | 440          |
| 20.0  | 30.0 × 45.0 × 42.0                             | 20.3        | B32676G4206K000                             | 24.0  | 3.3  | 13.0                                 | 1.0                                 | 6.9                                  | 400          |
| 25.0  | 33.0 × 48.0 × 42.0                             | 20.3        | B32676G4256K000                             | 28.0  | 2.8  | 14.0                                 | 1.0                                 | 7.1                                  | 180          |
| <b><math>V_{\text{R,85 °C}} = 630 \text{ V DC}, V_{\text{op,70 °C}} = 800 \text{ V DC}</math></b> |  |             |   |   |  |                                      |                                     |                                      |              |
| 2.7   | 24.0 × 15.0 × 41.5                             | —           | B32676T6275+000                             | 7.0   | 17.7   | 20.0                                 | 0.8                                 | 5.1                                  | 1040         |
| 3.5   | 24.0 × 19.0 × 41.5                             | —           | B32676T6355+000                             | 8.0   | 14.1   | 19.0                                 | 0.8                                 | 5.1                                  | 780          |
| 6.8   | 20.0 × 39.5 × 42.0                             | 10.2        | B32676G6685+000                             | 13.5  | 7.4  | 10.0                                 | 0.8                                 | 5.2                                  | 640          |
| 7.5   | 20.0 × 39.5 × 42.0                             | 10.2        | B32676G6755+000                             | 14.5  | 6.6  | 12.0                                 | 0.8                                 | 5.2                                  | 640          |
| 8.2   | 28.0 × 37.0 × 42.0                             | 10.2        | B32676G6825+000                             | 16.0  | 6.1  | 11.0                                 | 0.8                                 | 5.2                                  | 440          |
| 9.0   | 43.0 × 22.0 × 41.5                             | 20.3        | B32676T6905K000                             | 16.5  | 5.7  | 13.0                                 | 0.8                                 | 5.1                                  | 280          |
| 10.0  | 28.0 × 42.5 × 42.0                             | 10.2        | B32676G6106+000                             | 18.5  | 5.1  | 11.0                                 | 0.8                                 | 5.2                                  | 440          |
| 12.0  | 28.0 × 42.5 × 42.0                             | 10.2        | B32676G6126+000                             | 20.0  | 4.4  | 12.0                                 | 0.8                                 | 5.3                                  | 440          |
| 14.0  | 30.0 × 45.0 × 42.0                             | 20.3        | B32676G6146+000                             | 23.0  | 3.7  | 14.0                                 | 0.8                                 | 5.3                                  | 400          |
| 15.0  | 33.0 × 48.0 × 42.0                             | 20.3        | B32676G6156+000                             | 25.0  | 3.5  | 14.0                                 | 0.8                                 | 5.4                                  | 180          |

MOQ = Minimum Order Quantity, consisting of 4 packing units.

Intermediate capacitance values are available on request.

**Composition of ordering code**

+ = Capacitance tolerance code:

K =  $\pm 10\%$

J =  $\pm 5\%$

1) Capacitance value measured at 1 kHz

2) Max. ripple current  $I_{\text{RMS}}$  at 70 °C at 10 kHz for a  $\Delta T \leq 20$  °C when  $\Delta \text{ESR}_{\text{typ}} \leq \pm 5\%$

3) ESL value measured at resonance frequency (see specific graphs of Z versus frequency)

**B32676**
**MKP DC link – high power series**
**Ordering codes and packing units (lead spacing 37.5 mm)**

| $C_R^{4)}$   | Max. dimensions<br>$w \times h \times l$ | $P_1$ | Ordering code<br>(composition see<br>below) | $I_{RMS,max}^{5)}$<br>70 °C<br>10 kHz<br>A | $ESR_{typ}$<br>70 °C<br>10 kHz<br>mΩ | $ESL_{typ}^{6)}$<br>nH | $\tan \delta$<br>1 kHz<br>$10^{-3}$ | $\tan \delta$<br>10 kHz<br>$10^{-3}$ | pcs./<br>MOQ |
|--|--|-------|---|--|--------------------------------------|------------------------|-------------------------------------|--------------------------------------|--------------|
| $V_{R,85\text{ °C}} = 750\text{ V DC}, V_{op,70\text{ °C}} = 900\text{ V DC}$  |  |       |   |  |                                      |                        |                                     |                                      |              |
| 2.0  | 24.0 × 15.0 × 41.5                       | –     | B32676T1205+000                             | 6.0  | 22.7                                 | 18.0                   | 0.8                                 | 4.6                                  | 1040         |
| 2.7  | 24.0 × 19.0 × 41.5                       | –     | B32676T1275+000                             | 7.5  | 16.7                                 | 19.0                   | 0.8                                 | 4.6                                  | 780          |
| 4.7  | 20.0 × 39.5 × 42.0                       | 10.2  | B32676G1475+000                             | 12.0                                       | 9.5                                  | 10.0                   | 0.8                                 | 4.6                                  | 640          |
| 5.6  | 20.0 × 39.5 × 42.0                       | 10.2  | B32676G1565+000                             | 13.0                                       | 8.2                                  | 11.0                   | 0.8                                 | 4.7                                  | 640          |
| 6.8  | 28.0 × 37.0 × 42.0                       | 10.2  | B32676G1685+000                             | 15.5                                       | 6.7                                  | 11.0                   | 0.8                                 | 4.7                                  | 440          |
| 9.0  | 30.0 × 45.0 × 42.0                       | 20.3  | B32676G1905+000                             | 19.5                                       | 5.1                                  | 12.0                   | 0.8                                 | 4.7                                  | 440          |
| 10.0   | 30.0 × 45.0 × 42.0                       | 20.3  | B32676G1106+000                             | 20.5                                       | 4.7                                  | 13.0                   | 0.8                                 | 4.8                                  | 400          |
| 12.0   | 33.0 × 48.0 × 42.0                       | 20.3  | B32676G1126+000                             | 23.0                                       | 4.0                                  | 14.0                   | 0.8                                 | 4.8                                  | 180          |
| $V_{R,85\text{ °C}} = 875\text{ V DC}, V_{op,70\text{ °C}} = 1050\text{ V DC}$ |  |       |   |  |                                      |                        |                                     |                                      |              |
| 1.5  | 24.0 × 15.0 × 41.5                       | –     | B32676T8155+000                             | 5.5  | 26.2                                 | 18.0                   | 0.7                                 | 4.1                                  | 1040         |
| 2.0  | 24.0 × 19.0 × 41.5                       | –     | B32676T8205+000                             | 7.0  | 19.6                                 | 19.0                   | 0.7                                 | 4.1                                  | 780          |
| 3.3  | 20.0 × 39.5 × 42.0                       | 10.2  | B32676G8335+000                             | 10.5                                       | 12.0                                 | 9.0                    | 0.7                                 | 4.1                                  | 640          |
| 4.0  | 20.0 × 39.5 × 42.0                       | 10.2  | B32676G8405+000                             | 12.0                                       | 9.9                                  | 11.0                   | 0.7                                 | 4.1                                  | 640          |
| 4.7  | 28.0 × 37.0 × 42.0                       | 10.2  | B32676G8475+000                             | 13.5                                       | 8.6                                  | 10.0                   | 0.7                                 | 4.1                                  | 440          |
| 6.8  | 28.0 × 42.5 × 42.0                       | 10.2  | B32676G8685+000                             | 17.0                                       | 6.0                                  | 12.0                   | 0.7                                 | 4.2                                  | 440          |
| 7.5  | 30.0 × 45.0 × 42.0                       | 20.3  | B32676G8755+000                             | 19.0                                       | 5.4                                  | 13.0                   | 0.7                                 | 4.2                                  | 400          |
| 10.0   | 33.0 × 48.0 × 42.0                       | 20.3  | B32676G8106K000                             | 22.5                                       | 4.3                                  | 14.0                   | 0.7                                 | 4.3                                  | 180          |

MOQ = Minimum Order Quantity, consisting of 4 packing units.  
Intermediate capacitance values are available on request.

**Composition of ordering code**

+ = Capacitance tolerance code:

K = ±10%

J = ±5%

4) Capacitance value measured at 1 kHz

5) Max. ripple current  $I_{RMS}$  at 70 °C at 10 kHz for a  $\Delta T \leq 20\text{ °C}$  when  $\Delta ESR_{typ} \leq \pm 5\%$

6) ESL value measured at resonance frequency (see specific graphs of Z versus frequency)

**Ordering codes and packing units (lead spacing 52.5 mm)**

| $C_R^{1)}$<br>$\mu\text{F}$   | Max. dimensions<br>$w \times h \times l$<br>mm | $P_1$<br>mm | Ordering code<br>(composition see<br>below) | $I_{\text{RMS,max}}^{2)}$<br>70 °C<br>10 kHz<br>A | $\text{ESR}_{\text{typ}}$<br>70 °C<br>10 kHz<br>m $\Omega$ | $\text{ESL}_{\text{typ}}^{3)}$<br>nH | $\tan \delta$<br>1 kHz<br>$10^{-3}$ | $\tan \delta$<br>10 kHz<br>$10^{-3}$ | pcs./<br>MOQ |
|---|--|-------------|---|---|--|--------------------------------------|-------------------------------------|--------------------------------------|--------------|
| <b><math>V_{\text{R,85 °C}} = 300 \text{ V DC}, V_{\text{op,70 °C}} = 450 \text{ V DC}</math></b> |  |             |   |   |  |                                      |                                     |                                      |              |
| 30.0  | 43.0 × 24.0 × 57.5                             | 20.3        | B32678T3306K000                             | 22.5  | 3.9  | 13.0                                 | 1.5                                 | 11.8                                 | 560          |
| 40.0  | 30.0 × 45.0 × 57.5                             | 20.3        | B32678G3406+000                             | 28.0  | 3.0  | 12.0                                 | 1.5                                 | 12.3                                 | 280          |
| 47.0  | 35.0 × 50.0 × 57.5                             | 20.3        | B32678G3476+000                             | 33.0  | 2.6  | 13.0                                 | 1.5                                 | 12.5                                 | 108          |
| 60.0  | 35.0 × 50.0 × 57.5                             | 20.3        | B32678G3606K000                             | 37.0  | 2.1  | 15.0                                 | 1.6                                 | 12.9                                 | 108          |
| 80.0  | 45.0 × 57.0 × 57.5                             | 20.3        | B32678G3806+000                             | 47.0  | 1.6  | 18.0                                 | 1.6                                 | 13.5                                 | 140          |
| 80.0  | 130.0 × 24.0 × 57.5                            | 20.3        | B32678J3806K000                             | 51.0  | 1.4  | 4.0                                  | 1.5                                 | 11.7                                 | 80           |
| 100.0   | 60.0 × 45.0 × 57.5                             | 20.3        | B32678G3107+000                             | 48.0  | 1.4  | 19.0                                 | 1.6                                 | 13.5                                 | 200          |
| 270.0   | 130.0 × 58.0 × 57.5                            | 20.3        | B32678J3277K000                             | 108.0   | 0.5  | 6.0                                  | 1.6                                 | 13.8                                 | 40           |
| <b><math>V_{\text{R,85 °C}} = 450 \text{ V DC}, V_{\text{op,70 °C}} = 630 \text{ V DC}</math></b> |  |             |   |   |  |                                      |                                     |                                      |              |
| 20.0  | 43.0 × 24.0 × 57.5                             | 20.3        | B32678T4206K000                             | 20.0  | 4.9  | 13.0                                 | 1.3                                 | 9.8                                  | 560          |
| 30.0  | 35.0 × 50.0 × 57.5                             | 20.3        | B32678G4306+000                             | 28.0  | 3.2  | 14.0                                 | 1.3                                 | 9.9                                  | 108          |
| 35.0  | 35.0 × 50.0 × 57.5                             | 20.3        | B32678G4356+000                             | 31.5  | 2.8  | 14.0                                 | 1.3                                 | 10.0                                 | 108          |
| 40.0  | 35.0 × 50.0 × 57.5                             | 20.3        | B32678G4406K000                             | 34.0  | 2.5  | 15.0                                 | 1.3                                 | 10.2                                 | 108          |
| 60.0  | 45.0 × 57.0 × 57.5                             | 20.3        | B32678G4606+000                             | 45.0  | 1.8  | 18.0                                 | 1.4                                 | 11.2                                 | 140          |
| 60.0  | 130.0 × 24.0 × 57.5                            | 20.3        | B32678J4606K000                             | 49.5  | 1.6  | 4.0                                  | 1.2                                 | 9.5                                  | 80           |
| 65.0  | 60.0 × 45.0 × 57.5                             | 20.3        | B32678G4656+000                             | 48.0  | 1.6  | 19.0                                 | 1.3                                 | 10.6                                 | 200          |
| 180.0   | 130.0 × 58.0 × 57.5                            | 20.3        | B32678J4187K000                             | 97.5  | 0.6  | 6.0                                  | 1.4                                 | 11.2                                 | 40           |
| <b><math>V_{\text{R,85 °C}} = 630 \text{ V DC}, V_{\text{op,70 °C}} = 800 \text{ V DC}</math></b> |  |             |   |   |  |                                      |                                     |                                      |              |
| 13.0  | 43.0 × 24.0 × 57.5                             | 20.3        | B32678T6136K000                             | 18.0  | 5.9  | 13.0                                 | 1.1                                 | 7.9                                  | 560          |
| 20.0  | 35.0 × 50.0 × 57.5                             | 20.3        | B32678G6206+000                             | 26.5  | 4.0  | 13.0                                 | 1.1                                 | 8.2                                  | 108          |
| 25.0  | 35.0 × 50.0 × 57.5                             | 20.3        | B32678G6256+000                             | 29.5  | 3.3  | 15.0                                 | 1.1                                 | 8.3                                  | 108          |
| 38.0  | 130.0 × 24.0 × 57.5                            | 20.3        | B32678J6386K000                             | 43.5  | 2.1  | 4.0                                  | 1.1                                 | 7.9                                  | 80           |
| 40.0  | 45.0 × 57.0 × 57.5                             | 20.3        | B32678G6406+000                             | 41.0  | 2.1  | 18.0                                 | 1.2                                 | 8.8                                  | 140          |
| 45.0  | 60.0 × 45.0 × 57.5                             | 20.3        | B32678G6456+000                             | 43.0  | 1.9  | 19.0                                 | 1.2                                 | 8.7                                  | 200          |
| 120.0   | 130.0 × 58.0 × 57.5                            | 20.3        | B32678J6127K000                             | 90.0  | 0.7  | 6.0                                  | 1.2                                 | 8.8                                  | 40           |

MOQ = Minimum Order Quantity, consisting of 4 packing units.  
Intermediate capacitance values are available on request.

**Composition of ordering code**

+ = Capacitance tolerance code:  
K =  $\pm 10\%$   
J =  $\pm 5\%$

1) Capacitance value measured at 1 kHz  
2) Max. ripple current  $I_{\text{RMS}}$  at 70 °C at 10 kHz for a  $\Delta T \leq 20$  °C when  $\Delta \text{ESR}_{\text{typ}} \leq \pm 5\%$   
3) ESL value measured at resonance frequency (see specific graphs of Z versus frequency)

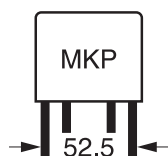
**B32678**
**MKP DC link – high power series**
**Ordering codes and packing units (lead spacing 52.5 mm)**

| $C_R^{4)}$   | Max. dimensions<br>$w \times h \times l$ | $P_1$ | Ordering code<br>(composition see<br>below) | $I_{RMS,max}^{5)}$<br>70 °C<br>10 kHz<br>A | $ESR_{typ}$<br>70 °C<br>10 kHz<br>mΩ | $ESL_{typ}^{6)}$<br>nH | $\tan \delta$<br>1 kHz<br>$10^{-3}$ | $\tan \delta$<br>10 kHz<br>$10^{-3}$ | pcs./<br>MOQ |
|--|--|-------|---|--|--------------------------------------|------------------------|-------------------------------------|--------------------------------------|--------------|
| $\mu F$  | mm                                       | mm    |   |  |                                      |                        |                                     |                                      |              |
| <b><math>V_{R,85\text{ °C}} = 750\text{ V DC}, V_{op,70\text{ °C}} = 900\text{ V DC}</math></b>  |  |       |   |  |                                      |                        |                                     |                                      |              |
| 9.0  | 43.0 × 24.0 × 57.5                       | 20.3  | B32678T1905K000                             | 16.5                                       | 7.2                                  | 13.0                   | 1.0                                 | 6.8                                  | 560          |
| 15.0   | 30.0 × 45.0 × 57.5                       | 20.3  | B32678G1156K000                             | 23.0                                       | 4.5                                  | 14.0                   | 1.0                                 | 7.0                                  | 280          |
| 20.0   | 35.0 × 50.0 × 57.5                       | 20.3  | B32678G1206K000                             | 28.0                                       | 3.5                                  | 15.0                   | 1.0                                 | 7.2                                  | 108          |
| 28.0   | 45.0 × 57.0 × 57.5                       | 20.3  | B32678G1286+000                             | 37.5                                       | 2.5                                  | 18.0                   | 1.0                                 | 7.4                                  | 140          |
| 30.0   | 60.0 × 45.0 × 57.5                       | 20.3  | B32678G1306+000                             | 39.5                                       | 2.4                                  | 19.0                   | 1.0                                 | 7.3                                  | 200          |
| 30.0   | 130.0 × 24.0 × 57.5                      | 20.3  | B32678J1306K000                             | 40.5                                       | 2.3                                  | 4.0                    | 1.0                                 | 6.8                                  | 80           |
| 85.0   | 130.0 × 58.0 × 57.5                      | 20.3  | B32678J1856K000                             | 82.5                                       | 0.9                                  | 6.0                    | 1.0                                 | 7.4                                  | 40           |
| <b><math>V_{R,85\text{ °C}} = 875\text{ V DC}, V_{op,70\text{ °C}} = 1050\text{ V DC}</math></b> |  |       |   |  |                                      |                        |                                     |                                      |              |
| 7.0  | 43.0 × 24.0 × 57.5                       | 20.3  | B32678T8705K000                             | 15.5                                       | 8.2                                  | 13.0                   | 0.9                                 | 6.0                                  | 560          |
| 15.0   | 35.0 × 50.0 × 57.5                       | 20.3  | B32678G8156K000                             | 26.5                                       | 4.0                                  | 15.0                   | 0.9                                 | 6.3                                  | 108          |
| 22.0   | 45.0 × 57.0 × 57.5                       | 20.3  | B32678G8226+000                             | 35.0                                       | 2.9                                  | 17.0                   | 1.0                                 | 6.5                                  | 140          |
| 22.0   | 130.0 × 24.0 × 57.5                      | 20.3  | B32678J8226K000                             | 39.0                                       | 2.6                                  | 5.0                    | 0.9                                 | 6.0                                  | 80           |
| 24.0   | 60.0 × 45.0 × 57.5                       | 20.3  | B32678G8246+000                             | 38.0                                       | 2.6                                  | 19.0                   | 0.9                                 | 6.4                                  | 200          |
| 65.0   | 130.0 × 58.0 × 57.5                      | 20.3  | B32678J8656K000                             | 78.0                                       | 1.0                                  | 6.0                    | 1.0                                 | 6.5                                  | 40           |

MOQ = Minimum Order Quantity, consisting of 4 packing units.  
Intermediate capacitance values are available on request.

**Composition of ordering code**

+ = Capacitance tolerance code:

K = ±10%

J = ±5%

4) Capacitance value measured at 1 kHz

5) Max. ripple current  $I_{RMS}$  at 70 °C at 10 kHz for a  $\Delta T \leq 20\text{ °C}$  when  $\Delta ESR_{typ} \leq \pm 5\%$

6) ESL value measured at resonance frequency (see specific graphs of Z versus frequency)

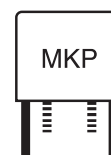

### Technical data

Reference standard: IEC 61071:2007 and AEC-Q200D. All data given at  $T = 20\text{ °C}$ , unless otherwise specified.

|  |  |   |     |     |      |
|--|--|---|-----|-----|------|
| Rated temperature $T_R$  | +85 °C   |   |     |     |      |
| Operating temperature range (case)   | Max. operating temperature, $T_{op,max}$   | +105 °C   |     |     |      |
|  | Upper category temperature $T_{max}$   | +105 °C   |     |     |      |
|  | Lower category temperature $T_{min}$   | -40 °C  |     |     |      |
| Insulation resistance $R_{ins}$<br>given as time constant<br>$\tau = C_R \cdot R_{ins}$ , rel. humidity $\leq 65\%$<br>(minimum as-delivered values) | $\tau > 10000\text{ s}$ (after 1 min)<br>For $V_R \geq 500\text{ V}$ measured at 500 V<br>For $V_R < 500\text{ V}$ measured at $V_R$   |   |     |     |      |
| DC voltage test between terminals (10 s)   | $1.5 \cdot V_R$  |   |     |     |      |
| Voltage test terminal to case (10 s)   | 2110 V AC, 50 Hz   |   |     |     |      |
| Pulse Handling Capability (V/ $\mu$ s)   | $I_P$ (A) / C ( $\mu$ F)   |   |     |     |      |
| Biased humidity<br>Limit values after test   | 1000 hours / 40 °C / 93% relative humidity with $V_{R,DC}$<br>Capacitance change $ \Delta C/C  \leq 5\%$<br>Dissipation factor change $\Delta \tan \delta \leq 0.002$ (at 1 kHz)<br>Insulation resistance $R_{ins} \geq 50\%$ of minimum as-delivered values |   |     |     |      |
| Reliability:   | Failure rate $\lambda$   | 1 fit ( $\leq 1 \cdot 10^{-9}/h$ ) at $0.5 \cdot V_R$ , 40 °C   |     |     |      |
|  | Service life $t_{SL}$  | 200 000 h at $V_R$ , 85 °C<br>For conversion to other operating conditions and temperatures, refer to chapter "Quality, 2 Reliability". |     |     |      |
| $V_R$ (V DC)   | 300  | 450   | 630 | 750 | 875  |
| Continuous operation voltage<br>$V_{op}$ (V DC) at 70 °C   | 450  | 630   | 800 | 900 | 1050 |
| Continuous operation voltage<br>$V_{op}$ (V DC) at 85 °C   | 300  | 450   | 630 | 750 | 875  |
| For temperatures between<br>85 °C and 100 °C   | 1.2%/°C of $V_{op}$ derating compared to $V_{op}$ at 85 °C   |   |     |     |      |

### Typical waveforms

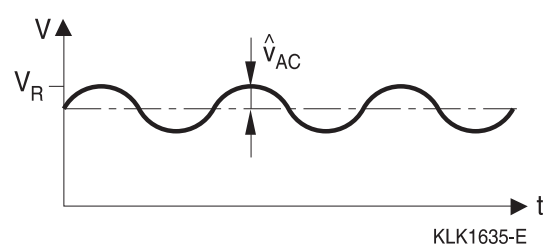

### Restrictions:

**$V_R$ :** Maximum operating peak voltage of either polarity but of a non-reversing waveform, for which the capacitor has been designed for continuous operation.



**B32674 ... B32678**

**MKP DC link – high power series**

$$\hat{u}_{AC} \leq 0.2 \cdot V_R$$

$$V_{p, max}$$

| Overvoltage      | Maximum duration within one day | Observation       |
|------------------|---------------------------------|-------------------|
| $1.1 \cdot V_R$  | 30% of on-load duration         | System regulation |
| $1.15 \cdot V_R$ | 30 min.                         | System regulation |
| $1.2 \cdot V_R$  | 5 min.                          | System regulation |
| $1.3 \cdot V_R$  | 1 min.                          | System regulation |

NOTE 1 An overvoltage equal to  $1.5 \cdot V_R$  for 30 ms is permitted 1000 times during the life of the capacitor.

The amplitudes of the overvoltages that may be tolerated without significant reduction in the life time of the capacitor depend on their duration, the number of application and the capacitor temperature.

In addition these values assume that the overvoltages may appear when the internal temperature of the capacitor is less than 0 °C but within the temperature category.

NOTE 2 The average applied voltage must not be higher than the specified voltage.

### Pulse handling capability

"dV/dt" represents the maximum permissible voltage change per unit of time for non-sinusoidal voltages, expressed in V/μs.

*Note:*

*The values of dV/dt and  $k_0$  provided below must not be exceeded in order to avoid damaging the capacitor. These parameters are given for isolated pulses in such a way that the heat generated by one pulse will be completely dissipated before applying the next pulse. For a train of pulses, please refer to the curves of permissible AC voltage-current versus frequency.*

### dV/dt values

| Lead spacing  | 27.5 mm |     |     |     |     | 37.5 mm |     |     |     |     | 52.5 mm |     |     |     |     |
|---------------|---------|-----|-----|-----|-----|---------|-----|-----|-----|-----|---------|-----|-----|-----|-----|
| Type          | B32674  |     |     |     |     | B32676  |     |     |     |     | B32678  |     |     |     |     |
| $V_R$ (V DC)  | 300     | 450 | 630 | 750 | 875 | 300     | 450 | 630 | 750 | 875 | 300     | 450 | 630 | 750 | 875 |
| dV/dt in V/μs | 40      | 75  | 100 | 125 | 150 | 22      | 54  | 73  | 85  | 100 | 15      | 35  | 50  | 60  | 70  |



**Characteristics curves**

Additional technical information can be found under "Design support" on [www.epcos.com](http://www.epcos.com).

**Impedance Z versus frequency f**  
(typical values)

Lead spacing 27.5 mm

300 V DC



**ESR versus frequency f**  
(typical values)

Lead spacing 27.5 mm

300 V DC



**Impedance Z versus frequency f**  
(typical values)

Lead spacing 27.5 mm

450 V DC



**ESR versus frequency f**  
(typical values)

Lead spacing 27.5 mm

450 V DC





**B32674**

**MKP DC link – high power series**

**Characteristics curves**

Additional technical information can be found under "Design support" on [www.epcos.com](http://www.epcos.com).

**Impedance Z versus frequency f**  
(typical values)

**Lead spacing 27.5 mm**

**630 V DC**



**ESR versus frequency f**  
(typical values)

**Lead spacing 27.5 mm**

**630 V DC**



**Impedance Z versus frequency f**  
(typical values)

**Lead spacing 27.5 mm**

**750 V DC**



**ESR versus frequency f**  
(typical values)

**Lead spacing 27.5 mm**

**750 V DC**





### Characteristics curves

Additional technical information can be found under "Design support" on [www.epcos.com](http://www.epcos.com).

#### Impedance Z versus frequency f (typical values)

Lead spacing 27.5 mm

875 V DC

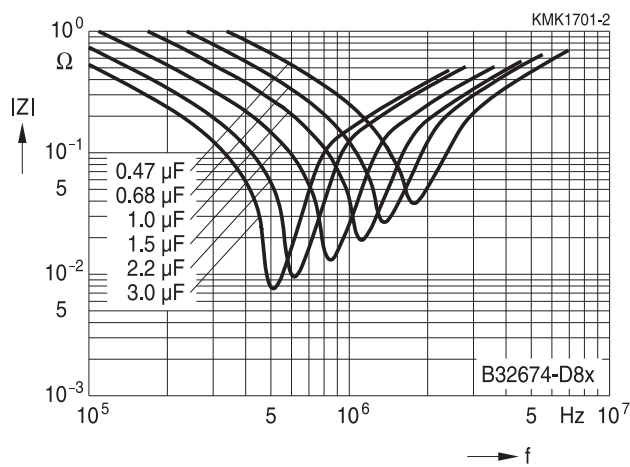

#### ESR versus frequency f (typical values)

Lead spacing 27.5 mm

875 V DC

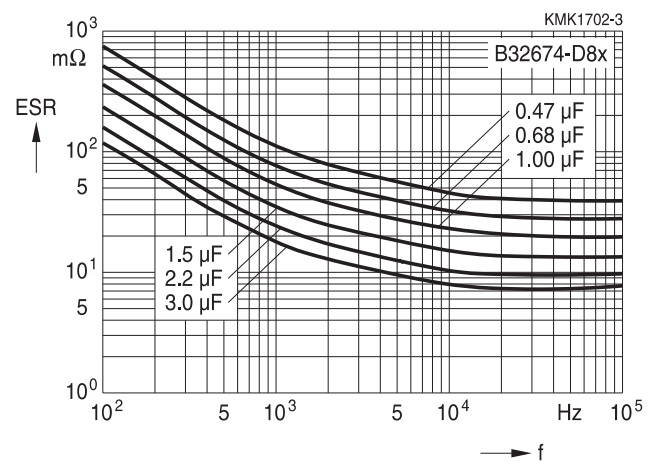



**B32676**

**MKP DC link – high power series**

**Characteristics curves**

Additional technical information can be found under "Design support" on [www.epcos.com](http://www.epcos.com).

**Impedance Z versus frequency f**  
(typical values)

**Lead spacing 37.5 mm**

**300 V DC**

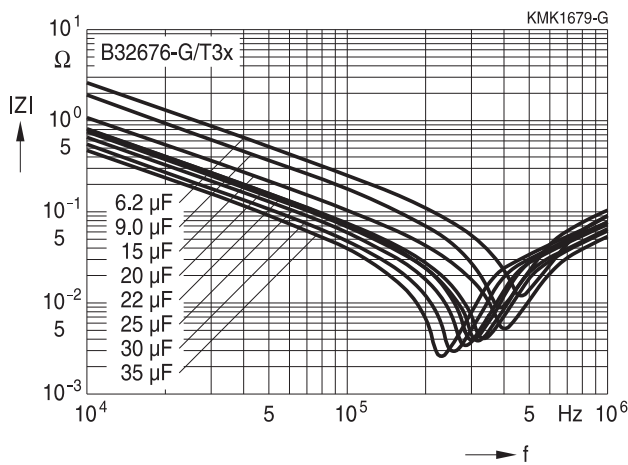

**ESR versus frequency f**  
(typical values)

**Lead spacing 37.5 mm**

**300 V DC**

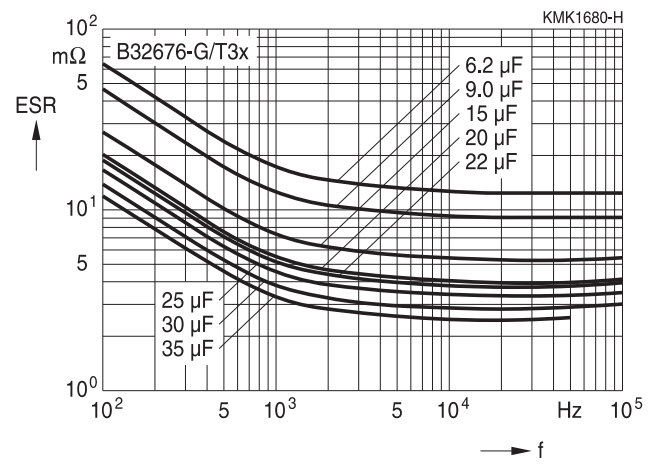

**Impedance Z versus frequency f**  
(typical values)

**Lead spacing 37.5 mm**

**450 V DC**



**ESR versus frequency f**  
(typical values)

**Lead spacing 37.5 mm**

**450 V DC**

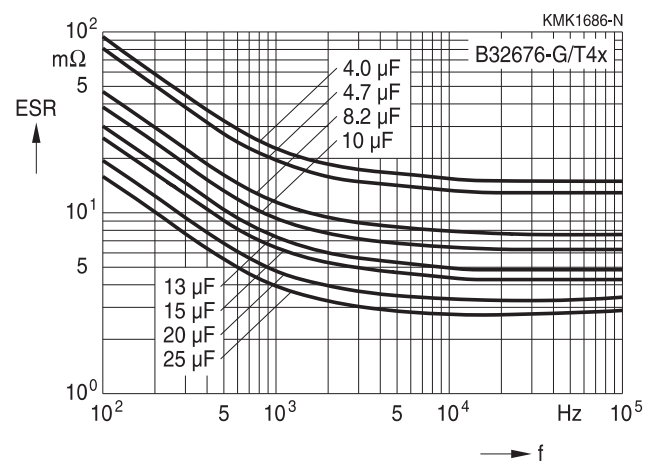

B32676

MKP DC link – high power series



**Characteristics curves**

Additional technical information can be found under "Design support" on [www.epcos.com](http://www.epcos.com).

**Impedance Z versus frequency f**  
(typical values)

Lead spacing 37.5 mm

630 V DC

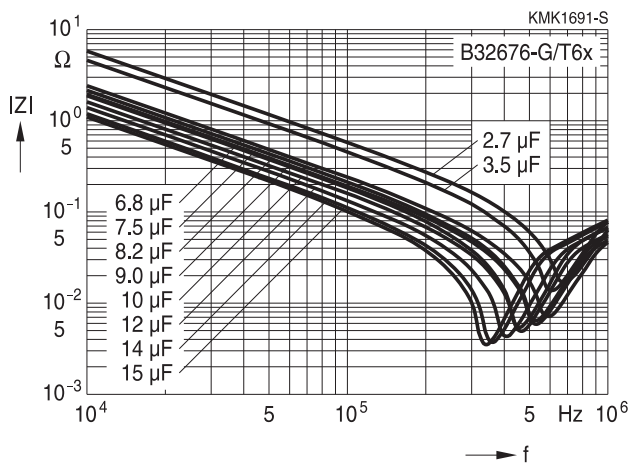

**ESR versus frequency f**  
(typical values)

Lead spacing 37.5 mm

630 V DC



**Impedance Z versus frequency f**  
(typical values)

Lead spacing 37.5 mm

750 V DC

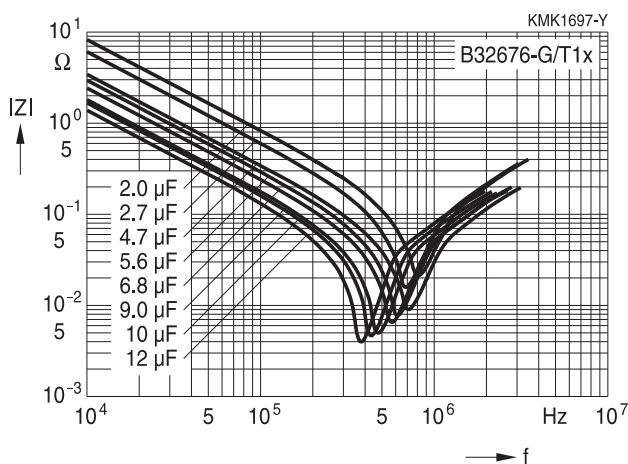

**ESR versus frequency f**  
(typical values)

Lead spacing 37.5 mm

750 V DC



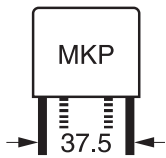

**B32676**

**MKP DC link – high power series**

**Characteristics curves**

Additional technical information can be found under "Design support" on [www.epcos.com](http://www.epcos.com).

**Impedance Z versus frequency f**  
(typical values)

**Lead spacing 37.5 mm**

**875 V DC**

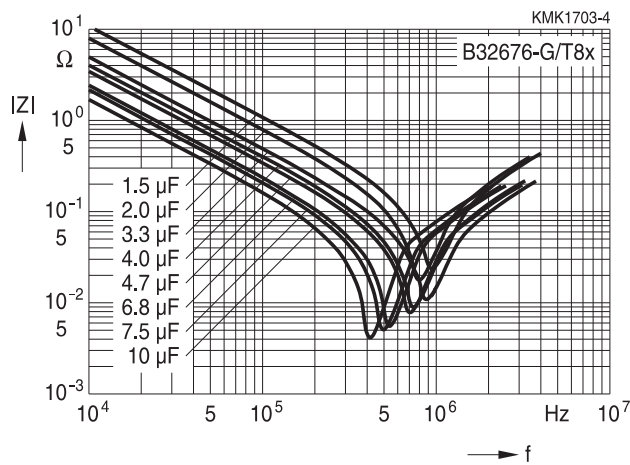

**ESR versus frequency f**  
(typical values)

**Lead spacing 37.5 mm**

**875 V DC**

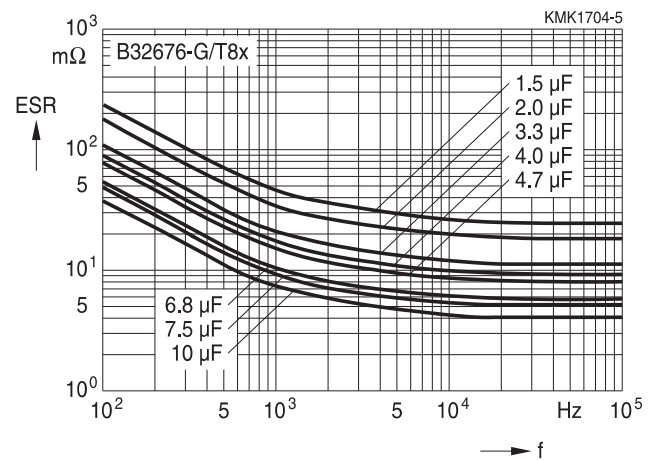

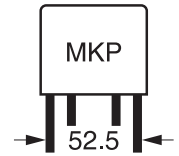

**Characteristics curves**

Additional technical information can be found under "Design support" on [www.epcos.com](http://www.epcos.com).

**Impedance Z versus frequency f**  
(typical values)

**Lead spacing 52.5 mm**

**300 V DC**

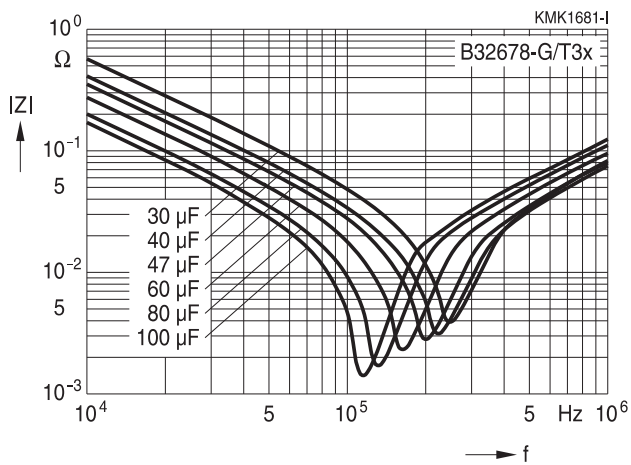

**ESR versus frequency f**  
(typical values)

**Lead spacing 52.5 mm**

**300 V DC**



**Impedance Z versus frequency f**  
(typical values)

**Lead spacing 52.5 mm**

**450 V DC**

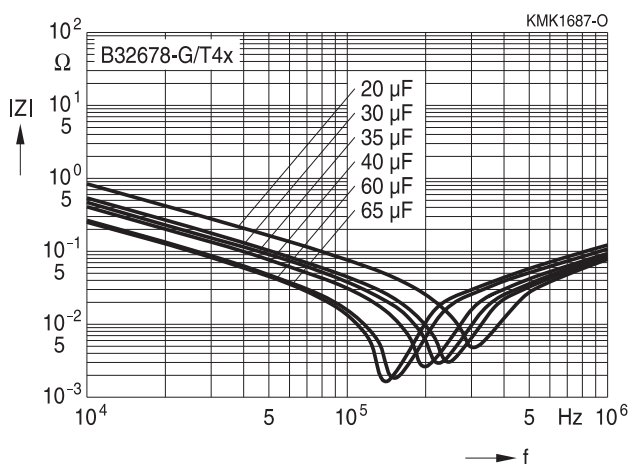

**ESR versus frequency f**  
(typical values)

**Lead spacing 52.5 mm**

**450 V DC**



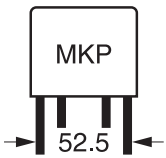

**B32678**  
**MKP DC link – high power series**

**Characteristics curves**

Additional technical information can be found under "Design support" on [www.epcos.com](http://www.epcos.com).

**Impedance Z versus frequency f**  
 (typical values)

**Lead spacing 52.5 mm**  
 630 V DC

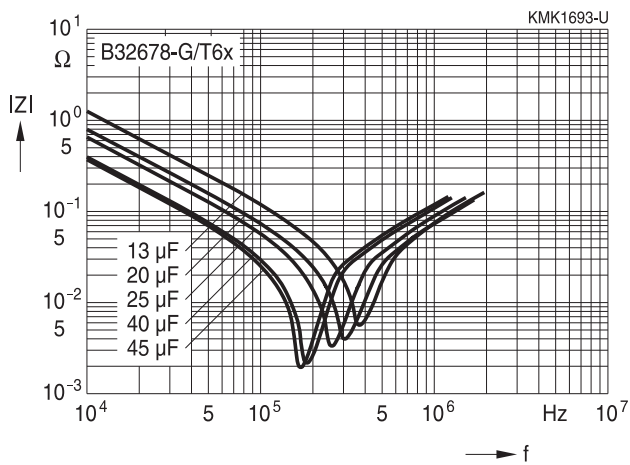

**ESR versus frequency f**  
 (typical values)

**Lead spacing 52.5 mm**  
 630 V DC

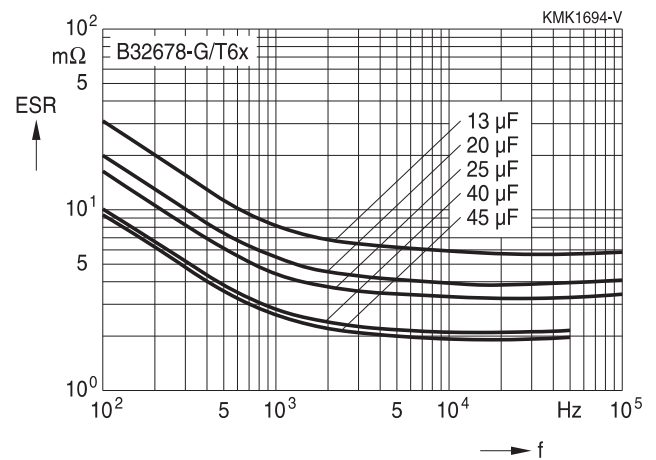

**Impedance Z versus frequency f**  
 (typical values)

**Lead spacing 52.5 mm**  
 750 V DC

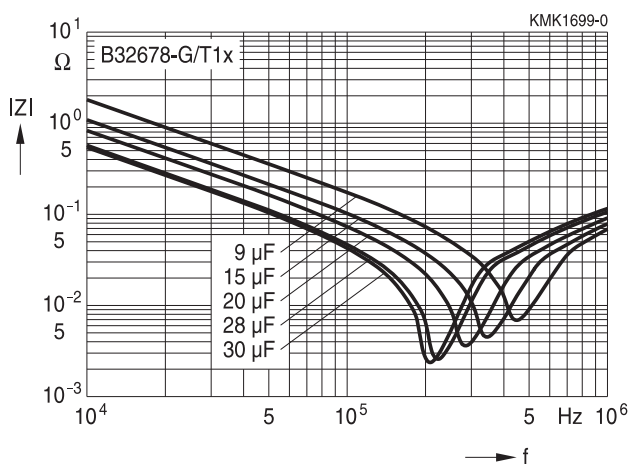

**ESR versus frequency f**  
 (typical values)

**Lead spacing 52.5 mm**  
 750 V DC

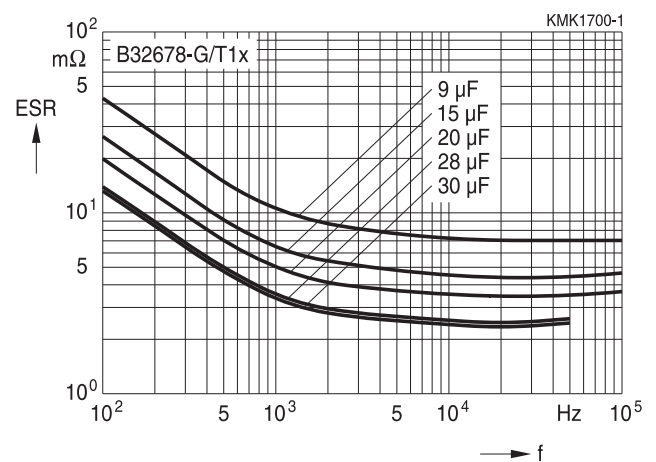

B32678

MKP DC link – high power series



**Characteristics curves**

Additional technical information can be found under "Design support" on [www.epcos.com](http://www.epcos.com).

**Impedance Z versus frequency f**  
(typical values)

Lead spacing 52.5 mm

875 V DC



**ESR versus frequency f**  
(typical values)

Lead spacing 52.5 mm

875 V DC

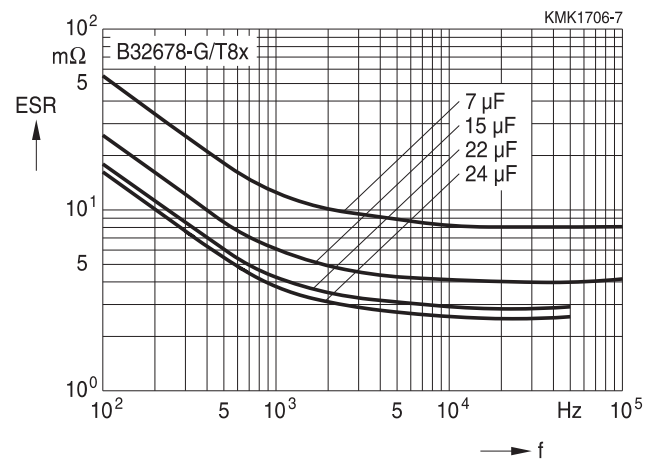

**Impedance Z versus frequency f**  
(typical values)

Lead spacing 52.5 mm (12 pins)

300 V DC, 450 V DC, 630 V DC,  
750 V DC, 875 V DC



**ESR versus frequency f**  
(typical values)

Lead spacing 52.5 mm (12 pins)

300 V DC, 450 V DC, 630 V DC,  
750 V DC, 875 V DC

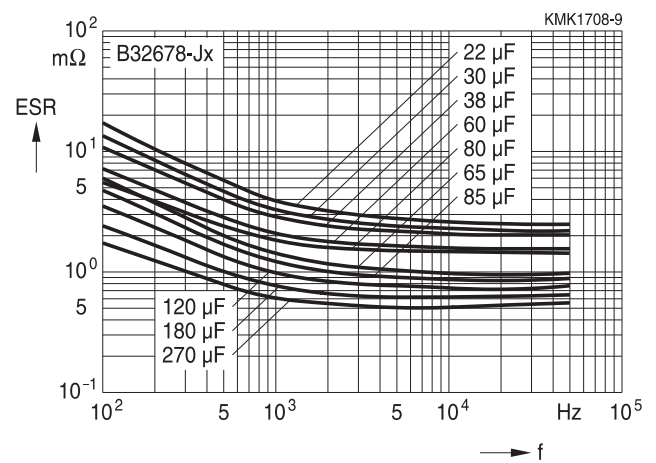



B32674

MKP DC link – high power series

**Characteristics curves**

**Permissible current  $I_{RMS}$  versus frequency  $f$  at 70 °C**

**Lead spacing 27.5 mm**

B32674D\*

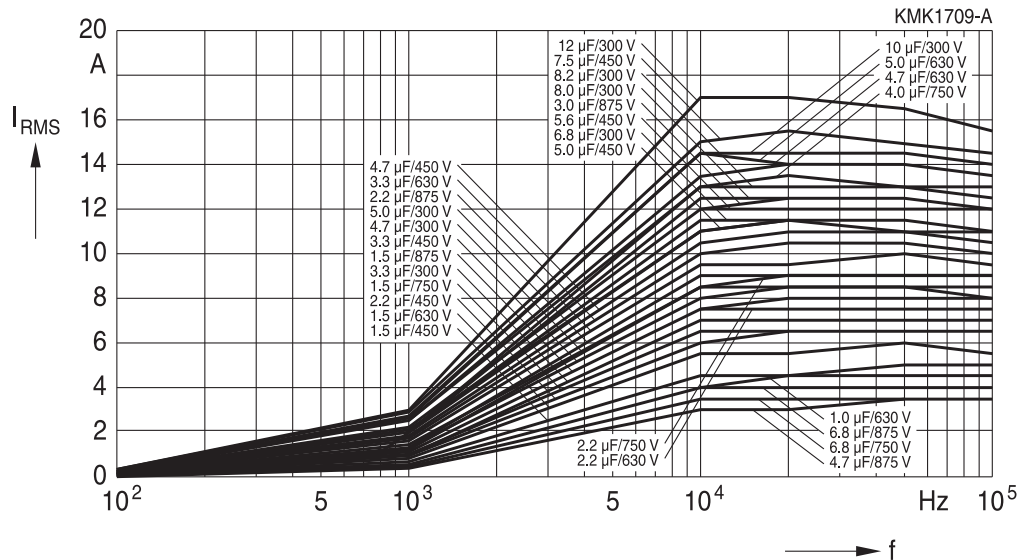



**Characteristics curves**

**Permissible current  $I_{RMS}$  versus frequency  $f$  at 70 °C**

**Lead spacing 37.5 mm**

**B32676G/T\***



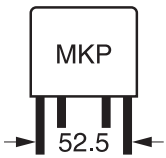

**B32678**

**MKP DC link – high power series**

**Characteristics curves**

**Permissible current  $I_{RMS}$  versus frequency  $f$  at 70 °C**

**Lead spacing 52.5 mm**

**B32678G/T\***



**B32678J\***



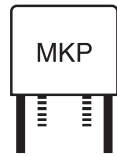

**Curves characteristics ( $I_{RMS}$  derating versus temperature)**

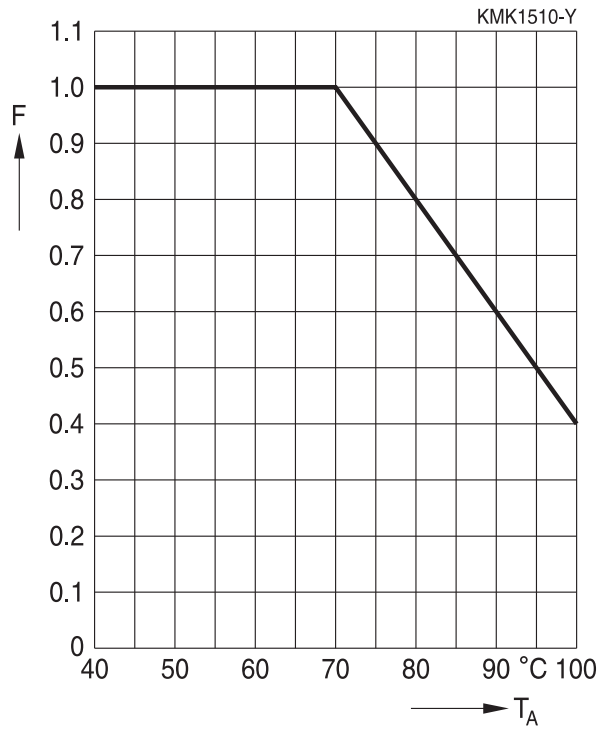

Maximum  $I_{RMS}$  current as function of the ambient temperature:  $I_{RMS}(T_A) = \text{Factor} \times I_{RMS}(70\text{ °C})$



B32674 ... B32678

MKP DC link – high power series

### Heat transference for self heating calculation



Figure 1 (2-pin, 4-pin)



Figure 2 (12-pin)

| Box dimensions |        |        | Equivalent heat coefficient<br>G (mW/°C) |
|----------------|--------|--------|--|
| w (mm)         | h (mm) | l (mm) |  |
| 11.0           | 19.0   | 31.5   | 25                                       |
| 11.0           | 21.0   | 31.5   | 28                                       |
| 12.5           | 21.5   | 31.5   | 30                                       |
| 13.5           | 23.0   | 31.5   | 32                                       |
| 14.0           | 24.5   | 31.5   | 35                                       |
| 15.0           | 24.5   | 31.5   | 36                                       |
| 16.0           | 32.0   | 31.5   | 45                                       |
| 18.0           | 27.5   | 31.5   | 44                                       |
| 18.0           | 33.0   | 31.5   | 48                                       |
| 19.0           | 30.0   | 31.5   | 48                                       |
| 20.0           | 11.0   | 31.5   | 65                                       |
| 21.0           | 31.0   | 31.5   | 51                                       |
| 22.0           | 36.5   | 31.5   | 58                                       |
| 12.0           | 22.0   | 41.5   | 70                                       |
| 14.0           | 25.0   | 41.5   | 43                                       |
| 16.0           | 28.5   | 41.5   | 50                                       |
| 18.0           | 32.5   | 41.5   | 59                                       |
| 20.0           | 39.5   | 42.0   | 72                                       |
| 24.0           | 19.0   | 41.5   | 50                                       |
| 24.0           | 15.0   | 41.5   | 44                                       |
| 28.0           | 37.0   | 42.0   | 83                                       |
| 28.0           | 42.5   | 42.0   | 90                                       |
| 30.0           | 45.0   | 42.0   | 100                                      |
| 33.0           | 48.0   | 42.0   | 110                                      |
| 43.0           | 22.0   | 41.5   | 80                                       |
| 30.0           | 45.0   | 57.5   | 125                                      |
| 35.0           | 50.0   | 57.5   | 145                                      |
| 43.0           | 24.0   | 57.5   | 103                                      |
| 45.0           | 57.0   | 57.5   | 185                                      |
| 60.0           | 45.0   | 57.5   | 192                                      |
| 130.0          | 24.0   | 57.5   | 200                                      |
| 130.0          | 58.0   | 57.5   | 300                                      |

The equivalent heat coefficient "**G (mW/°C)**" is given for measuring the temperature on the lateral surface of the plastic box as figure1 shows. By using a thermocouple and avoiding effect of radiation and convection the temperature measured during operation conditions should be a result of the dissipated power divided by the equivalent heat coefficient.

### Self Heating by power dissipation and equivalent heat coefficient

The  $I_{RMS}$  and consequently the power dissipation must be limited during operation in order to not exceed the maximum limit of  $\Delta T$  allowed for this series.  $\Delta T_{max}$  given for this series is equal or lower than 20 °C at rated temperature (70 °C), for higher ambient temperatures  $\Delta T_{max}(T)$  will have the same derating factor than  $I_{RMS}$  versus temperature and then an equivalent derating as per:

$$\Delta T_{max}(T) = (\text{Factor})^2 \times \Delta T(70\text{ °C}).$$

For any particular  $I_{RMS}$  the  $\Delta T$  may be calculated by:

$$\Delta T(\text{°C}) = P_{dis}(\text{mW}) / G(\text{mW/°C}).$$

Where  $\Delta T(\text{°C})$  is the difference between the temperature measured on the box (see figure 1) and the ambient temperature when capacitor is working during normal operation;

$$\Delta T(\text{°C}) = T_{op}(\text{°C}) - T_A(\text{°C}).$$

It represents the increasing of temperature provoked by the  $I_{RMS}$  during operation.

$G(\text{mW/°C})$  is the equivalent heat coefficient described above and  $P_{dis}(\text{mW})$  is the dissipated power defined by:

$$P_{dis}(\text{mW}) = ESR_{typ}(\text{m}\Omega) \times I_{RMS}^2(\text{A}_{RMS}).$$

### Example for thermal calculation:

We will take as reference B32678G8156K (15  $\mu\text{F}/875\text{ V}$ ) type for thermal calculation. Considering the following load and capacitor characteristics:

$I_{RMS}$ : 15  $A_{RMS}$  at 20 kHz

$T_A$ : 85 °C

35 × 50 × 57.5 box

$G(\text{mW/°C})$ : 145

Then we have to find the  $ESR_{typ}$  at 20 kHz what is approximately 4.0 m $\Omega$ .

So according to  $P_{dis}(\text{mW}) = ESR_{typ}(\text{m}\Omega) \times I_{RMS}^2(\text{A}_{RMS})$

we have the following:  $P_{dis}(\text{mW}) = 4.0\text{ m}\Omega \times 15\text{ A}_{RMS}^2 = 900\text{ mW}.$

And as per  $\Delta T(\text{°C}) = P_{dis}(\text{mW}) / G(\text{mW/°C})$

we have the following:  $\Delta T(\text{°C}) = 900(\text{mW}) / 145(\text{mW/°C}) = 6.2\text{ °C}.$

What is below of the  $\Delta T_{max}(85\text{ °C}) = (\text{Factor})^2 \times \Delta T(70\text{ °C}) = (0.7)^2 \times 20\text{ °C} = 9.8\text{ °C}.$

On the other hand we may confirm that max  $I_{RMS}$  at 20 kHz at 70 °C = 26.5  $A_{RMS}$ .

And then max  $I_{RMS}$  for 85 °C of ambient temperature is defined as follows:

$$I_{RMS}(85\text{ °C}) = \text{Factor} \times I_{RMS}(70\text{ °C}) = 0.7 \times 26.5\text{ A}_{RMS} = 18.55\text{ A}_{RMS}.$$

What confirms once again that  $I_{RMS}$  (15  $A_{RMS}$  at 20 kHz at 85 °C) is below the max specified for such frequency and ambient temperature.



B32674 ... B32678

MKP DC link – high power series

**Life time expectancy - typical curve**

B3267\*3/4/6/1/8 (300 V DC / 450 V DC / 630 V DC / 750 V DC / 875 V DC)



Note: Confidence level of 98%

**Testing and Standards**

| Test  | Reference  | Conditions of test  | Performance requirements   |
|---|--|---|--|
| Electrical parameters<br>(Routine test)     | IEC61071:2007                                    | Voltage between terminals,<br>1.5 V <sub>R</sub> , during 10 s<br>Insulation resistance, R <sub>ins</sub> at V <sub>R</sub> if<br>V <sub>R</sub> < 500 V or 500 V if V <sub>R</sub> ≥ 500 V<br>Capacitance, C at 1 kHz<br>(room temperature)<br>Dissipation factor, tan δ at 1/10 kHz<br>(room temperature) | Within specified limits  |
| Robustness of terminations<br>(Type test)   | IEC<br>60068-2-21:2006                           | Tensile strength (test Ua1)<br>Wire diameter   Tensile force<br>0.5 < d <sub>1</sub> ≤ 0.8 mm   10 N<br>0.8 < d <sub>1</sub> ≤ 1.25 mm   20 N   | Capacitance and tan δ within specified limits  |
| Resistance to soldering heat<br>(Type test) | IEC<br>60068-2-20:2008,<br>test Tb,<br>method 1A | Solder bath temperature at 260 ± 5 °C,<br>immersion for 10 seconds  | ΔC/C <sub>0</sub>   ≤ 2%<br> Δ tan δ  ≤ 0.002  |
| Rapid change of temperature<br>(Type test)  | IEC<br>60384-16:2005                             | T <sub>A</sub> = lower category temperature<br>T <sub>B</sub> = upper category temperature<br>Five cycles, duration t = 30 min.   | ΔC/C <sub>0</sub>   ≤ 2%<br> Δ tan δ  ≤ 0.002<br>R <sub>ins</sub> ≥ 50% of initial limit                       |
| Vibration<br>(Type test)                    | IEC<br>60384-16:2005                             | Test F <sub>C</sub> : vibration sinusoidal<br>Displacement: 0.75 mm<br>Acceleration: 98 m/s <sup>2</sup><br>Frequency: 10 Hz ... 500 Hz<br>Test duration: 3 orthogonal axes,<br>2 hours each axe  | No visible damage  |
| Bump<br>(Type test)                         | IEC<br>60384-16:2005                             | Test Eb: Total 4000 bumps with<br>390 m/s <sup>2</sup> mounted on PCB<br>Duration: 6 ms   | No visible damage<br> ΔC/C <sub>0</sub>   ≤ 2%<br> Δ tan δ  ≤ 0.002<br>R <sub>ins</sub> ≥ 50% of initial limit |
| Climatic sequence<br>(Type test)            | IEC<br>60384-16:2005                             | Dry heat Tb / 16 h<br>Damp heat cyclic, 1 <sup>st</sup> cycle<br>+55 °C / 24 h / 95% ... 100% RH<br>Cold Ta / 2 h<br>Damp heat cyclic, 5 cycles<br>+55 °C / 24 h / 95% ... 100% RH  | No visible damage<br> ΔC/C <sub>0</sub>   ≤ 3%<br> Δ tan δ  ≤ 0.001<br>R <sub>ins</sub> ≥ 50% of initial limit |



B32674 ... B32678

MKP DC link – high power series

| Test                                | Reference         | Conditions of test  | Performance requirements   |
|-------------------------------------|-------------------|---|--|
| Damp heat, steady state (Type test) | IEC 60384-16:2005 | Test Ca<br>40 °C / 93% RH / 56 days   | No visible damage<br>$ \Delta C/C_0  \leq 5\%$<br>$ \Delta \tan \delta  \leq 0.005$<br>$R_{ins} \geq 50\%$ of initial limit          |
| Endurance (Type test)               | IEC61071:2007     | 70 °C / 1.4 $V_R$ / 250 hours or<br>$T_{op}$ / 1.4 $V_{op}$ / 250 hours<br>+ 1000 discharges at 1.4 $I_R$<br>+70 °C / 1.4 $V_R$ / 250 hours or<br>$T_{op}$ / 1.4 $V_{op}$ / 250 hours | No visible damage<br>$ \Delta C/C_0  \leq 3\%$ at 1 kHz<br>$ \Delta \tan \delta  \leq 0.015$ at 10 kHz                               |
| Endurance (Type test)               | IEC 60384-16:2005 | 70 °C / 1.25 $V_R$ / 1000 hours or<br>85 °C / 1.25 $V_{op}$ / 1000 hours or<br>100 °C / 1.25 $V_{op}$ / 1000 hours  | No visible damage<br>$ \Delta C/C_0  \leq 5\%$ at 1 kHz<br>$ \Delta \tan \delta  \leq 0.005$<br>$R_{ins} \geq 50\%$ of initial limit |

## Mounting guidelines

### 1 Soldering

#### 1.1 Solderability of leads

The solderability of terminal leads is tested to IEC 60068-2-20, test Ta, method 1.

Before a solderability test is carried out, terminals are subjected to accelerated ageing (to IEC 60068-2-2, test Ba: 4 h exposure to dry heat at 155 °C). Since the ageing temperature is far higher than the upper category temperature of the capacitors, the terminal wires should be cut off from the capacitor before the ageing procedure to prevent the solderability being impaired by the products of any capacitor decomposition that might occur.

|                         |   |
|-------------------------|---|
| Solder bath temperature | 235 ±5 °C   |
| Soldering time          | 2.0 ±0.5 s  |
| Immersion depth         | 2.0 +0/–0.5 mm from capacitor body or seating plane             |
| Evaluation criteria:    |   |
| Visual inspection       | Wetting of wire surface by new solder ≥90%, free-flowing solder |

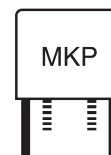

## 1.2 Resistance to soldering heat

Resistance to soldering heat is tested to IEC 60068-2-20, test Tb, method 1.

Conditions:

| Series  | Solder bath temperature | Soldering time  |
|---|-------------------------|---|
| MKT boxed (except 2.5 × 6.5 × 7.2 mm)<br>coated<br>uncoated (lead spacing >10 mm) | 260 ±5 °C               | 10 ±1 s   |
| MFP   |                         |   |
| MKP (lead spacing >7.5 mm)  |                         |   |
| MKT boxed (case 2.5 × 6.5 × 7.2 mm)   | 260 ±5 °C               | 5 ±1 s  |
| MKP (lead spacing ≤7.5 mm)  |                         | <4 s  |
| MKT uncoated (lead spacing ≤10 mm)<br>insulated (B32559)                          |                         | recommended soldering<br>profile for MKT uncoated<br>(lead spacing ≤ 10 mm) and<br>insulated (B32559) |

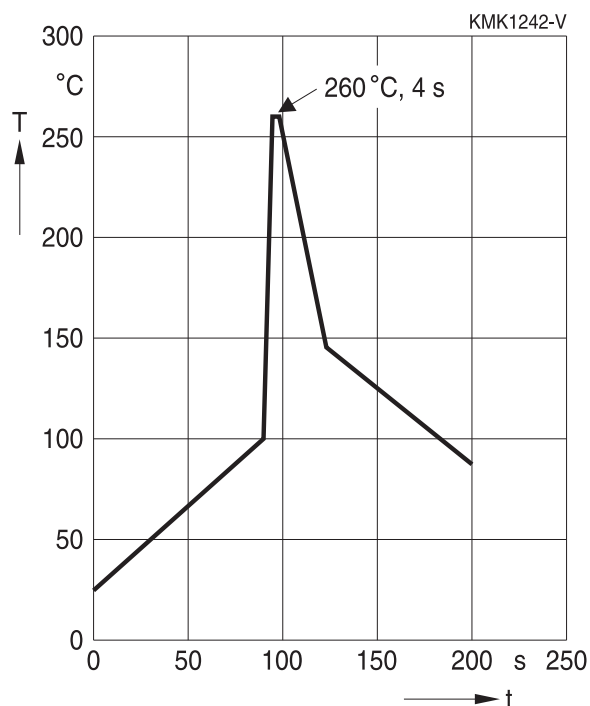

|                      |   |
|----------------------|---|
| Immersion depth      | 2.0 +0/−0.5 mm from capacitor body or seating plane                                 |
| Shield               | Heat-absorbing board, (1.5 ±0.5) mm thick, between capacitor body and liquid solder |
| Evaluation criteria: |   |
| Visual inspection    | No visible damage   |
| $\Delta C/C_0$       | 2% for MKT/MKP/MFP<br>5% for EMI suppression capacitors                             |
| $\tan \delta$        | As specified in sectional specification   |



B32674 ... B32678

MKP DC link – high power series

### 1.3 General notes on soldering

Permissible heat exposure loads on film capacitors are primarily characterized by the upper category temperature  $T_{max}$ . Long exposure to temperatures above this type-related temperature limit can lead to changes in the plastic dielectric and thus change irreversibly a capacitor's electrical characteristics. For short exposures (as in practical soldering processes) the heat load (and thus the possible effects on a capacitor) will also depend on other factors like:

- Pre-heating temperature and time
- Forced cooling immediately after soldering
- Terminal characteristics:  
diameter, length, thermal resistance, special configurations (e.g. crimping)
- Height of capacitor above solder bath
- Shadowing by neighboring components
- Additional heating due to heat dissipation by neighboring components
- Use of solder-resist coatings

The overheating associated with some of these factors can usually be reduced by suitable countermeasures. For example, if a pre-heating step cannot be avoided, an additional or reinforced cooling process may possibly have to be included.

#### EPCOS recommendations

As a reference, the recommended wave soldering profile for our film capacitors is as follows:



$T_s$ : Capacitor body maximum temperature at wave soldering

$T_p$ : Capacitor body maximum temperature at pre-heating

KMK1745-A-E

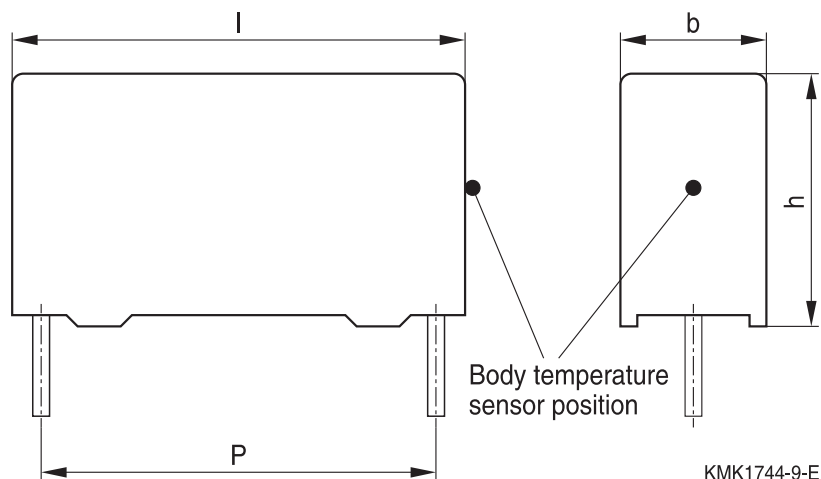

Body temperature should follow the description below:

- MKP capacitor
  - During pre-heating:  $T_p \leq 110 \text{ }^\circ\text{C}$
  - During soldering:  $T_s \leq 120 \text{ }^\circ\text{C}$ ,  $t_s \leq 45 \text{ s}$
- MKT capacitor
  - During pre-heating:  $T_p \leq 125 \text{ }^\circ\text{C}$
  - During soldering:  $T_s \leq 160 \text{ }^\circ\text{C}$ ,  $t_s \leq 45 \text{ s}$

When SMD components are used together with leaded ones, the film capacitors should not pass into the SMD adhesive curing oven. The leaded components should be assembled after the SMD curing step.

Leaded film capacitors are not suitable for reflow soldering.

In order to ensure proper conditions for manual or selective soldering, the body temperature of the capacitor ( $T_s$ ) must be  $\leq 120 \text{ }^\circ\text{C}$ .

One recommended condition for manual soldering is that the tip of the soldering iron should be  $< 360 \text{ }^\circ\text{C}$  and the soldering contact time should be no longer than 3 seconds.

For uncoated MKT capacitors with lead spacings  $\leq 10 \text{ mm}$  (B32560/B32561) the following measures are recommended:

- pre-heating to not more than  $110 \text{ }^\circ\text{C}$  in the preheater phase
- rapid cooling after soldering

Please refer to EPCOS Film Capacitor Data Book in case more details are needed.



**B32674 ... B32678**

**MKP DC link – high power series**

### Cautions and warnings

- Do not exceed the upper category temperature (UCT).
- Do not apply any mechanical stress to the capacitor terminals.
- Avoid any compressive, tensile or flexural stress.
- Do not move the capacitor after it has been soldered to the PC board.
- Do not pick up the PC board by the soldered capacitor.
- Do not place the capacitor on a PC board whose PTH hole spacing differs from the specified lead spacing.
- Do not exceed the specified time or temperature limits during soldering.
- Avoid external energy inputs, such as fire or electricity.
- Avoid overload of the capacitors.
- Consult us if application is with severe temperature and humidity condition.
- There are no serviceable or repairable parts inside the capacitor. Opening the capacitor or any attempts to open or repair the capacitor will void the warranty and liability of EPCOS.
- Please note that the standards referred to in this publication may have been revised in the meantime.

The table below summarizes the safety instructions that must always be observed. A detailed description can be found in the relevant sections of the chapters "General technical information" and "Mounting guidelines".

| Topic                   | Safety information  | Reference chapter<br>"General technical information" |
|-------------------------|---|--|
| Storage conditions      | Make sure that capacitors are stored within the specified range of time, temperature and humidity conditions.   | 4.5<br>"Storage conditions"                          |
| Flammability            | Avoid external energy, such as fire or electricity (passive flammability), avoid overload of the capacitors (active flammability) and consider the flammability of materials.   | 5.3<br>"Flammability"                                |
| Resistance to vibration | Do not exceed the tested ability to withstand vibration. The capacitors are tested to IEC 60068-2-6:2007. EPCOS offers film capacitors specially designed for operation under more severe vibration regimes such as those found in automotive applications. Consult our catalog "Film Capacitors for Automotive Electronics". | 5.2<br>"Resistance to vibration"                     |

| Topic     | Safety information   | Reference chapter<br>"Mounting guidelines" |
|-----------|--|--|
| Soldering | Do not exceed the specified time or temperature limits during soldering. | 1 "Soldering"                              |
| Cleaning  | Use only suitable solvents for cleaning capacitors.                      | 2 "Cleaning"                               |



| Topic  | Safety information  | Reference chapter<br>"Mounting guidelines"         |
|--|---|--|
| Embedding of capacitors in finished assemblies | When embedding finished circuit assemblies in plastic resins, chemical and thermal influences must be taken into account.<br>Caution: Consult us first, if you also wish to embed other uncoated component types! | 3 "Embedding of capacitors in finished assemblies" |

### Display of ordering codes for EPCOS products

The ordering code for one and the same product can be represented differently in data sheets, data books, other publications and the website of EPCOS, or in order-related documents such as shipping notes, order confirmations and product labels. **The varying representations of the ordering codes are due to different processes employed and do not affect the specifications of the respective products.** Detailed information can be found on the Internet under [www.epcos.com/orderingcodes](http://www.epcos.com/orderingcodes).



B32674 ... B32678

MKP DC link – high power series

## Symbols and terms

| Symbol               | English   | German  |
|----------------------|---|---|
| $\alpha$             | Heat transfer coefficient   | Wärmeübergangszahl  |
| $\alpha_C$           | Temperature coefficient of capacitance                                    | Temperaturkoeffizient der Kapazität   |
| A                    | Capacitor surface area  | Kondensatoroberfläche   |
| $\beta_C$            | Humidity coefficient of capacitance                                       | Feuchtekoeffizient der Kapazität  |
| C                    | Capacitance   | Kapazität   |
| $C_R$                | Rated capacitance   | Nennkapazität   |
| $\Delta C$           | Absolute capacitance change   | Absolute Kapazitätsänderung   |
| $\Delta C/C$         | Relative capacitance change (relative deviation of actual value)          | Relative Kapazitätsänderung (relative Abweichung vom Ist-Wert)                  |
| $\Delta C/C_R$       | Capacitance tolerance (relative deviation from rated capacitance)         | Kapazitätstoleranz (relative Abweichung vom Nennwert)                           |
| dt                   | Time differential   | Differentielle Zeit   |
| $\Delta t$           | Time interval   | Zeitintervall   |
| $\Delta T$           | Absolute temperature change (self-heating)                                | Absolute Temperaturänderung (Selbsterwärmung)                                   |
| $\Delta \tan \delta$ | Absolute change of dissipation factor                                     | Absolute Änderung des Verlustfaktors  |
| $\Delta V$           | Absolute voltage change   | Absolute Spannungsänderung  |
| dV/dt                | Time differential of voltage function (rate of voltage rise)              | Differentielle Spannungsänderung (Spannungsflankensteilheit)                    |
| $\Delta V/\Delta t$  | Voltage change per time interval  | Spannungsänderung pro Zeitintervall   |
| E                    | Activation energy for diffusion   | Aktivierungsenergie zur Diffusion   |
| ESL                  | Self-inductance   | Eigeninduktivität   |
| ESR                  | Equivalent series resistance  | Ersatz-Serienwiderstand   |
| f                    | Frequency   | Frequenz  |
| $f_1$                | Frequency limit for reducing permissible AC voltage due to thermal limits | Grenzfrequenz für thermisch bedingte Reduzierung der zulässigen Wechselspannung |
| $f_2$                | Frequency limit for reducing permissible AC voltage due to current limit  | Grenzfrequenz für strombedingte Reduzierung der zulässigen Wechselspannung      |
| $f_r$                | Resonant frequency  | Resonanzfrequenz  |
| $F_D$                | Thermal acceleration factor for diffusion                                 | Therm. Beschleunigungsfaktor zur Diffusion                                      |
| $F_T$                | Derating factor   | Deratingfaktor  |
| i                    | Current (peak)  | Stromspitze   |
| $I_C$                | Category current (max. continuous current)                                | Kategoriestrom (max. Dauerstrom)  |

| Symbol           | English  | German  |
|------------------|--|---|
| $I_{RMS}$        | (Sinusoidal) alternating current, root-mean-square value | (Sinusförmiger) Wechselstrom                      |
| $i_z$            | Capacitance drift  | Inkonstanz der Kapazität                          |
| $k_0$            | Pulse characteristic                                     | Impuls Kennwert                                   |
| $L_S$            | Series inductance  | Serieninduktivität                                |
| $\lambda$        | Failure rate   | Ausfallrate                                       |
| $\lambda_0$      | Constant failure rate during useful service life         | Konstante Ausfallrate in der Nutzungsphase        |
| $\lambda_{test}$ | Failure rate, determined by tests                        | Experimentell ermittelte Ausfallrate              |
| $P_{diss}$       | Dissipated power   | Abgegebene Verlustleistung                        |
| $P_{gen}$        | Generated power  | Erzeugte Verlustleistung                          |
| $Q$              | Heat energy  | Wärmeenergie                                      |
| $\rho$           | Density of water vapor in air                            | Dichte von Wasserdampf in Luft                    |
| $R$              | Universal molar constant for gases                       | Allg. Molarkonstante für Gas                      |
| $R$              | Ohmic resistance of discharge circuit                    | Ohmscher Widerstand des Entladekreises            |
| $R_i$            | Internal resistance                                      | Innenwiderstand                                   |
| $R_{ins}$        | Insulation resistance                                    | Isolationswiderstand                              |
| $R_P$            | Parallel resistance                                      | Parallelwiderstand                                |
| $R_S$            | Series resistance  | Serienwiderstand                                  |
| $S$              | severity (humidity test)                                 | Schärfegrad (Feuchtetest)                         |
| $t$              | Time   | Zeit  |
| $T$              | Temperature  | Temperatur  |
| $\tau$           | Time constant  | Zeitkonstante                                     |
| $\tan \delta$    | Dissipation factor                                       | Verlustfaktor                                     |
| $\tan \delta_D$  | Dielectric component of dissipation factor               | Dielektrischer Anteil des Verlustfaktors          |
| $\tan \delta_P$  | Parallel component of dissipation factor                 | Parallelanteil des Verlustfaktors                 |
| $\tan \delta_S$  | Series component of dissipation factor                   | Serienanteil des Verlustfaktors                   |
| $T_A$            | Temperature of the air surrounding the component         | Temperatur der Luft, die das Bauteil umgibt       |
| $T_{max}$        | Upper category temperature                               | Obere Kategorietemperatur                         |
| $T_{min}$        | Lower category temperature                               | Untere Kategorietemperatur                        |
| $t_{OL}$         | Operating life at operating temperature and voltage      | Betriebszeit bei Betriebstemperatur und -spannung |
| $T_{op}$         | Operating temperature, $T_A + \Delta T$                  | Betriebstemperatur, $T_A + \Delta T$              |
| $T_R$            | Rated temperature  | Nenntemperatur                                    |
| $T_{ref}$        | Reference temperature                                    | Referenztemperatur                                |
| $t_{SL}$         | Reference service life                                   | Referenz-Lebensdauer                              |



B32674 ... B32678

MKP DC link – high power series

| Symbol      | English   | German                                      |
|-------------|---|---|
| $V_{AC}$    | AC voltage  | Wechselspannung                             |
| $V_C$       | Category voltage  | Kategorie <span>spannung</span>             |
| $V_{C,RMS}$ | Category AC voltage   | (Sinusförmige)<br>Kategorie-Wechselspannung |
| $V_{CD}$    | Corona-discharge onset voltage                              | Teilentlade-Einsatzspannung                 |
| $V_{ch}$    | Charging voltage  | Ladespannung                                |
| $V_{DC}$    | DC voltage  | Gleichspannung                              |
| $V_{FB}$    | Fly-back capacitor voltage                                  | Spannung (Flyback)                          |
| $V_i$       | Input voltage   | Eingangsspannung                            |
| $V_o$       | Output voltage  | Ausgangsspannung                            |
| $V_{op}$    | Operating voltage   | Betriebsspannung                            |
| $V_p$       | Peak pulse voltage  | Impuls-Spitzen <span>spannung</span>        |
| $V_{pp}$    | Peak-to-peak voltage Impedance                              | Spannungshub                                |
| $V_R$       | Rated voltage   | Nennspannung                                |
| $\hat{V}_R$ | Amplitude of rated AC voltage                               | Amplitude der Nenn-Wechselspannung          |
| $V_{RMS}$   | (Sinusoidal) alternating voltage,<br>root-mean-square value | (Sinusförmige) Wechselspannung              |
| $V_{SC}$    | S-correction voltage  | Spannung bei Anwendung "S-correction"       |
| $V_{sn}$    | Snubber capacitor voltage                                   | Spannung bei Anwendung<br>"Beschaltung"     |
| $Z$         | Impedance   | Scheinwiderstand                            |
| $e$         | Lead spacing  | Rastermaß                                   |

## Important notes

The following applies to all products named in this publication:

1. Some parts of this publication contain **statements about the suitability of our products for certain areas of application**. These statements are based on our knowledge of typical requirements that are often placed on our products in the areas of application concerned. We nevertheless expressly point out **that such statements cannot be regarded as binding statements about the suitability of our products for a particular customer application**. As a rule, EPCOS is either unfamiliar with individual customer applications or less familiar with them than the customers themselves. For these reasons, it is always ultimately incumbent on the customer to check and decide whether an EPCOS product with the properties described in the product specification is suitable for use in a particular customer application.
2. We also point out that **in individual cases, a malfunction of electronic components or failure before the end of their usual service life cannot be completely ruled out in the current state of the art, even if they are operated as specified**. In customer applications requiring a very high level of operational safety and especially in customer applications in which the malfunction or failure of an electronic component could endanger human life or health (e.g. in accident prevention or lifesaving systems), it must therefore be ensured by means of suitable design of the customer application or other action taken by the customer (e.g. installation of protective circuitry or redundancy) that no injury or damage is sustained by third parties in the event of malfunction or failure of an electronic component.
3. **The warnings, cautions and product-specific notes must be observed.**
4. In order to satisfy certain technical requirements, **some of the products described in this publication may contain substances subject to restrictions in certain jurisdictions (e.g. because they are classed as hazardous)**. Useful information on this will be found in our Material Data Sheets on the Internet ([www.epcos.com/material](http://www.epcos.com/material)). Should you have any more detailed questions, please contact our sales offices.
5. We constantly strive to improve our products. Consequently, **the products described in this publication may change from time to time**. The same is true of the corresponding product specifications. Please check therefore to what extent product descriptions and specifications contained in this publication are still applicable before or when you place an order. We also **reserve the right to discontinue production and delivery of products**. Consequently, we cannot guarantee that all products named in this publication will always be available. The aforementioned does not apply in the case of individual agreements deviating from the foregoing for customer-specific products.
6. Unless otherwise agreed in individual contracts, **all orders are subject to the current version of the "General Terms of Delivery for Products and Services in the Electrical Industry" published by the German Electrical and Electronics Industry Association (ZVEI)**.



## Important notes

7. **Our manufacturing sites serving the automotive business apply the IATF 16949 standard.** The IATF certifications confirm our compliance with requirements regarding the quality management system in the automotive industry. Referring to customer requirements and customer specific requirements (“CSR”) TDK always has and will continue to have the policy of respecting individual agreements. Even if IATF 16949 may appear to support the acceptance of unilateral requirements, we hereby like to emphasize that **only requirements mutually agreed upon can and will be implemented in our Quality Management System.** For clarification purposes we like to point out that obligations from IATF 16949 shall only become legally binding if individually agreed upon.
8. The trade names EPCOS, CeraCharge, CeraDiode, CeraLink, CeraPad, CeraPlas, CSMP, CTVS, DeltaCap, DigiSiMic, ExoCore, FilterCap, FormFit, LeaXield, MiniBlue, MiniCell, MKD, MKK, MotorCap, PCC, PhaseCap, PhaseCube, PhaseMod, PhiCap, PowerHap, PQSine, PQvar, SIFERRIT, SIFI, SIKOREL, SilverCap, SIMDAD, SiMic, SIMID, SineFormer, SIOV, ThermoFuse, WindCap are **trademarks registered or pending** in Europe and in other countries. Further information will be found on the Internet at [www.epcos.com/trademarks](http://www.epcos.com/trademarks).



Release 2018-06

## Looking for pricing, stock, or lifecycle information?

Click below to explore more details on WIN SOURCE:

-  [View B32676E8225J on WIN SOURCE](#)
-  [EPCOS \(TDK\) Information](#)

## Optimize Your Supply Chain with WIN SOURCE Solutions

-  Global Sourcing Solution
-  Obsolete Management
-  Cost Control Management
-  Shortage Management
-  Alternative Solution
-  Excess Inventory Management