



**THE DATASHEET OF
DDA124EUQ-13-F**



Features

- Epitaxial Planar Die Construction
- Complementary NPN Types Available (DDC)
- Built-In Biasing Resistors
- **Totally Lead-Free & Fully RoHS Compliant (Notes 1 & 2)**
- **Halogen and Antimony Free. "Green" Device (Note 3)**
- **The DDA (XXXX) UQ are suitable for automotive applications requiring specific change control; these parts are AEC-Q101 qualified, PPAP capable, and manufactured in IATF 16949 certified facilities.**

<https://www.diodes.com/quality/product-definitions/>

Part Number	R1 (NOM)	R2 (NOM)
DDA124EU	22kΩ	22kΩ
DDA144EU	47kΩ	47kΩ
DDA114YU	10kΩ	47kΩ
DDA123JU	2.2kΩ	47kΩ
DDA114EU	10kΩ	10kΩ

Mechanical Data

- Case: SOT363
- Case Material: Molded Plastic, "Green" Molding Compound
- UL Flammability Classification Rating 94V-0
- Moisture Sensitivity: Level 1 per J-STD-020
- Terminals: Finish – Matte Tin Plated Leads, Solderable per MIL-STD-202, Method 208 Ⓜ3
- Weight: 0.006 grams (Approximate)

Part Number	R1 Only
DDA113TU	1kΩ
DDA143TU	4.7kΩ
DDA114TU	10kΩ



Top View

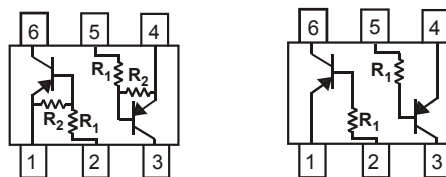

R1, R2

R1 Only

Device Schematic

Ordering Information (Notes 4, 5)

Product	Status	Compliance	Marking	Reel Size (inches)	Tape Width (mm)	Quantity per Reel
DDA124EU-7-F	Active	Standard	P17	7	8	3,000
DDA124EUQ-7-F	Active	Automotive	P17	7	8	3,000
DDA124EUQ-13-F	Active	Automotive	P17	13	8	10,000
DDA144EU-7-F	Active	Standard	P20	7	8	3,000
DDA144EUQ-7-F	Active	Automotive	P20	7	8	3,000
DDA114YU-7-F	Active	Standard	P14	7	8	3,000
DDA114YUQ-7-F	NRND (Use ADA114YUQ)	Automotive	P14	7	8	3,000
DDA123JU-7-F	Active	Standard	P06	7	8	3,000
DDA114EU-7-F	Active	Standard	P13	7	8	3,000
DDA114EUQ-7-F	NRND (Use ADA114EUQ)	Automotive	P13	7	8	3,000
DDA113TU-7-F	Active	Standard	P01	7	8	3,000
DDA143TU-7-F	Active	Standard	P07	7	8	3,000
DDA143TUQ-7-F	Active	Automotive	P07	7	8	3,000
DDA143TUQ-13-F	Active	Automotive	P07	13	8	10,000
DDA114TU-7-F	Active	Standard	P12	7	8	3,000
DDA114TUQ-7-F	Active	Automotive	P12	7	8	3,000
DDA114TUQ-13-F	Active	Automotive	P12	13	8	10,000

- Notes:
1. No purposely added lead. Fully EU Directive 2002/95/EC (RoHS), 2011/65/EU (RoHS 2) & 2015/863/EU (RoHS 3) compliant.
 2. See <https://www.diodes.com/quality/lead-free/> for more information about Diodes Incorporated's definitions of Halogen- and Antimony-free, "Green" and Lead-free.
 3. Halogen- and Antimony-free "Green" products are defined as those which contain <900ppm bromine, <900ppm chlorine (<1500ppm total Br + Cl) and <1000ppm antimony compounds.
 4. For packaging details, go to our website at <https://www.diodes.com/design/support/packaging/diodes-packaging/>.
 5. NRND = Not Recommended for New Design.

Marking Information

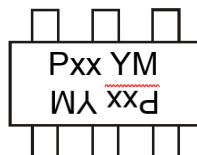

Pxx = Product Type Marking Code (See Ordering Information)
 YM = Date Code Marking
 Y = Year (ex: 1 = 2021)
 M = Month (ex: 9 = September)

Date Code Key

Year	2018	2021	2022	2023	2024	2025	2026	2027	2028	2029	2030
Code	F	I	J	K	L	M	N	O	P	R	S
Month	Jan	Feb	Mar	Apr	May	Jun	Jul	Aug	Sep	Oct	Nov	Dec
Code	1	2	3	4	5	6	7	8	9	O	N	D

Absolute Maximum Ratings (@ T_A = +25°C, unless otherwise specified.)

Characteristic	Symbol	Value	Unit
Supply Voltage (1) to (6) and (4) to (3)	V _{CC}	-50	V
Input Voltage (1) to (2) and (4) to (5)	V _{IN}	+10 to -40 +10 to -40 +6 to -40 +5 to -12 +10 to -40 +5V Max +5V Max +5V Max	V
Output Current	I _O	-30 -30 -70 -100 -50 -100 -100 -100	mA
Output Current	I _{C(max)}	-100	mA

Thermal Characteristics (@ T_A = +25°C, unless otherwise specified.)

Characteristic	Symbol	Value	Unit
Power Dissipation (Notes 6, 7)	P _D	200	mW
Thermal Resistance, Junction to Ambient Air (Note 6)	R _{θJA}	625	°C/W
Operating and Storage Temperature Range	T _J , T _{STG}	-55 to +150	°C

Notes: 6. Mounted on FR-4 PC Board with minimum recommended pad layout.
 7. 150mW per element must not be exceeded.

Electrical Characteristics (@ T_A = +25°C, unless otherwise specified.)

Characteristic (DDA113TU & DDA143TU & DDA114TU only)	Symbol	Min	Typ	Max	Unit	Test Condition
Collector-Base Breakdown Voltage	BV _{CB0}	-50	—	—	V	I _C = -50μA
Collector-Emitter Breakdown Voltage	BV _{CEO}	-50	—	—	V	I _C = -1mA
Emitter-Base Breakdown Voltage	BV _{EBO}	-5	—	—	V	I _E = -50μA
Collector Cutoff Current	I _{CB0}	—	—	-0.5	μA	V _{CB} = -50V
Emitter Cutoff Current	I _{EBO}	—	—	-0.5	μA	V _{EB} = -4V
Collector-Emitter Saturation Voltage	V _{CE(sat)}	—	—	-0.3	V	I _C /I _B = -2.5mA / -0.25mA DDA143TU I _C /I _B = -1mA / -0.1mA DDA114TU I _C /I _B = -10mA / -1mA DDA113TU
DC Current Transfer Ratio	h _{FE}	100 160	250 —	600 600	—	I _C = -1mA, V _{CE} = -5V I _C = -1mA, V _{CE} = -5V DDA143TU/Q
Input Resistor (R ₁) Tolerance	ΔR ₁	-30	—	+30	%	—
Gain-Bandwidth Product (Note 8)	f _T	—	250	—	MHz	V _{CE} = -10V, I _E = 5mA, f = 100MHz

Characteristic	Symbol	Min	Typ	Max	Unit	Test Condition	
Input Voltage	V _{I(off)}	DDA124EU	-0.5	-1.1	—	V	V _{CC} = -5V, I _O = -100μA
		DDA144EU	-0.5	-1.1	—		
DDA114YU		-0.3	—	—			
DDA123JU		-0.5	—	—			
DDA114EU		-0.5	-1.1	—			
Input Voltage	V _{I(on)}	DDA124EU	—	-1.9	-3.0	V	V _O = -0.3, I _O = -5mA V _O = -0.3, I _O = -2mA V _O = -0.3, I _O = -1mA V _O = -0.3, I _O = -5mA V _O = -0.3, I _O = -10mA
		DDA144EU	—	-1.9	-3.0		
		DDA114YU	—	—	-1.4		
		DDA123JU	—	—	-1.1		
		DDA114EU	—	-1.9	-3.0		
Output Voltage	V _{O(on)}	—	-0.1	-0.3	V	I _O /I _I = -10mA / -0.5mA I _O /I _I = -10mA / -0.5mA I _O /I _I = -5mA / -0.25mA I _O /I _I = -5mA / -0.25mA I _O /I _I = -10mA / -0.5mA	
Input Current	I _I	—	—	-0.36 -0.18 -0.88 -3.6 -0.88	mA	V _I = -5V	
Output Current	I _{O(off)}	—	—	-0.5	μA	V _{CC} = -50V, V _I = -0V	
DC Current Gain	G _I	56 60 68 68 80 30	—	—	—	V _O = -5V, I _O = -5mA V _O = -5V, I _O = -5mA V _O = -5V, I _O = -5mA V _O = -5V, I _O = -10mA V _O = -5V, I _O = -10mA V _O = -5V, I _O = -5mA	
Input Resistor (R ₁) Tolerance	ΔR ₁	-30	—	+30	%	—	
Resistance Ratio Tolerance	R ₂ /R ₁	-20	—	+20	%	—	
Gain-Bandwidth Product (Note 8)	f _T	—	250	—	MHz	V _{CE} = -10V, I _E = -5mA, f = 100MHz	

Note: 8. Transistor - For Reference Only.

Typical Curves – DDA123JU (@ $T_A = +25^\circ\text{C}$, unless otherwise specified.)

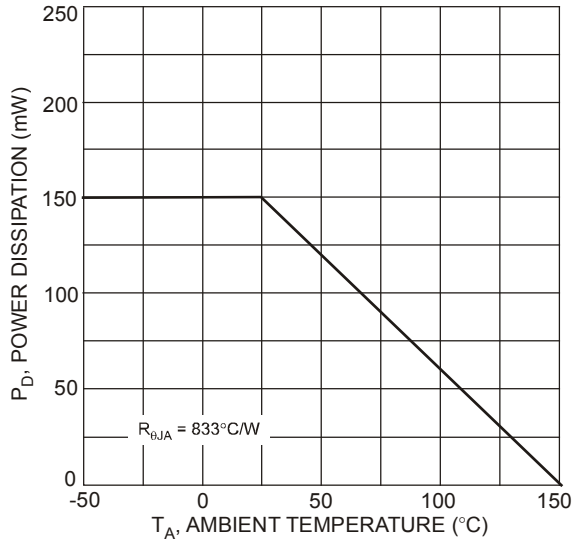

Fig. 1 Power Dissipation vs. Ambient Temperature

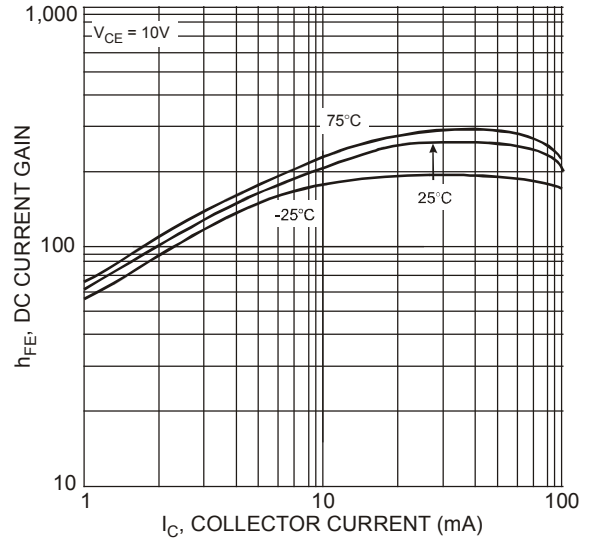

Fig. 2 Typical DC Current Gain vs. Collector Current

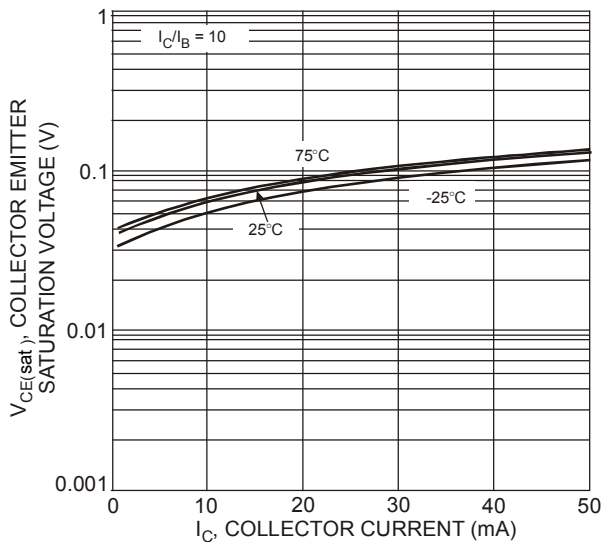

Fig. 3 Typical Collector Emitter Saturation Voltage vs. Collector Current

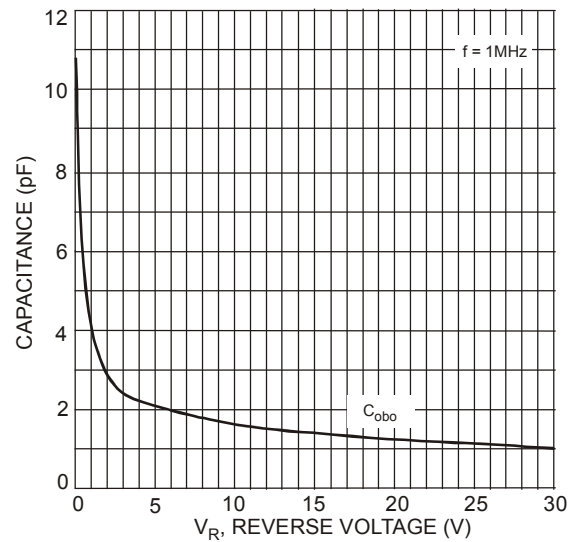

Fig. 4 Typical Capacitance Characteristics

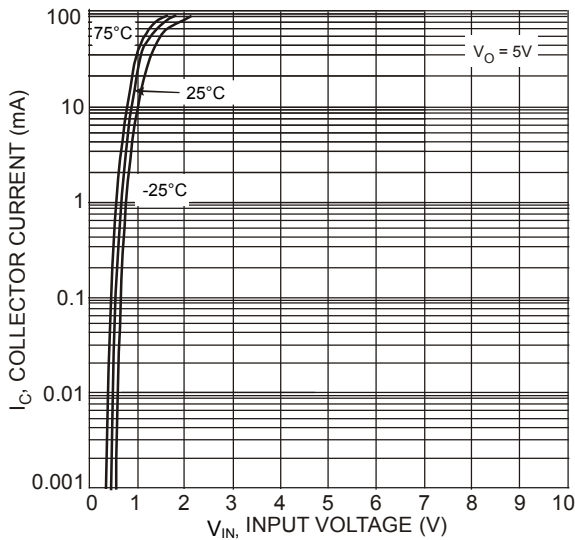

Fig. 5 Collector Current vs. Input Voltage

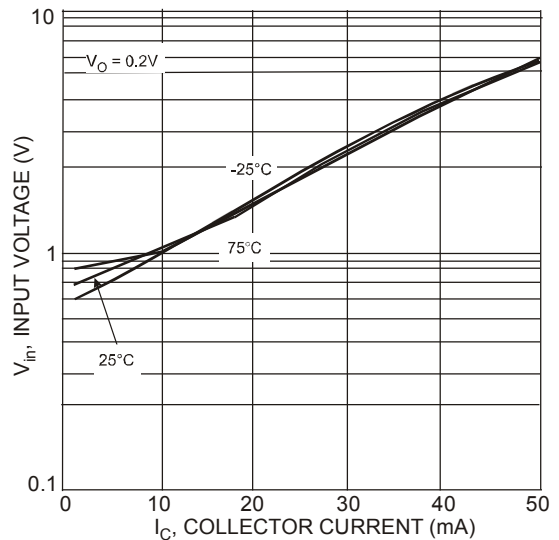

Fig. 6 Input Voltage vs. Collector Current

Typical Curves – DDA114TU (@ $T_A = +25^\circ\text{C}$, unless otherwise specified.)

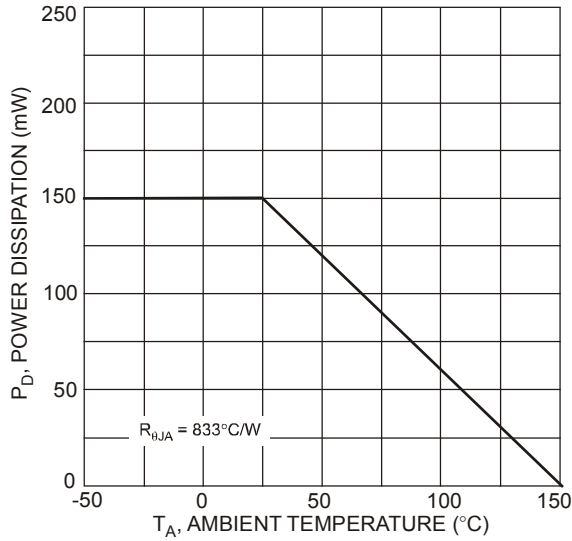

Fig.7 Power Dissipation vs. Ambient Temperature

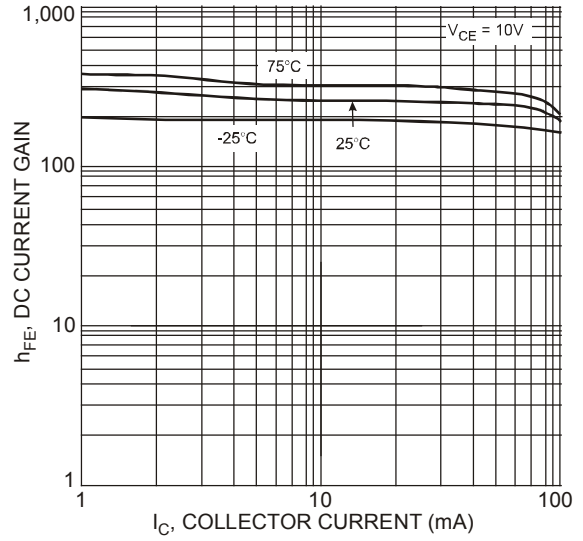

Fig.8 Typical DC Current Gain vs. Collector Current

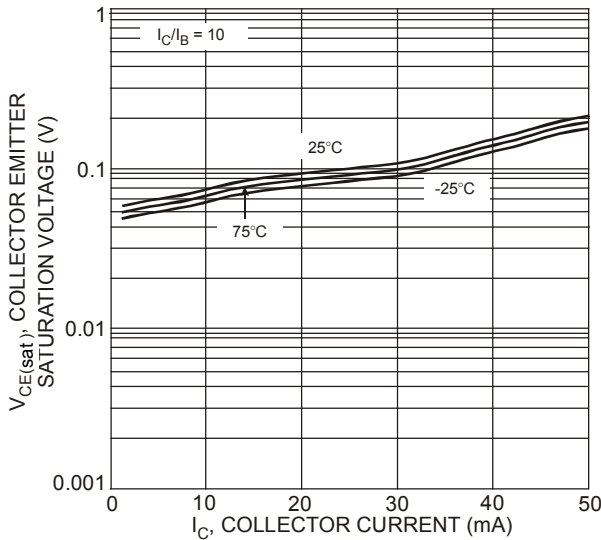

Fig.9 Typical Collector Emitter Saturation Voltage vs. Collector Current

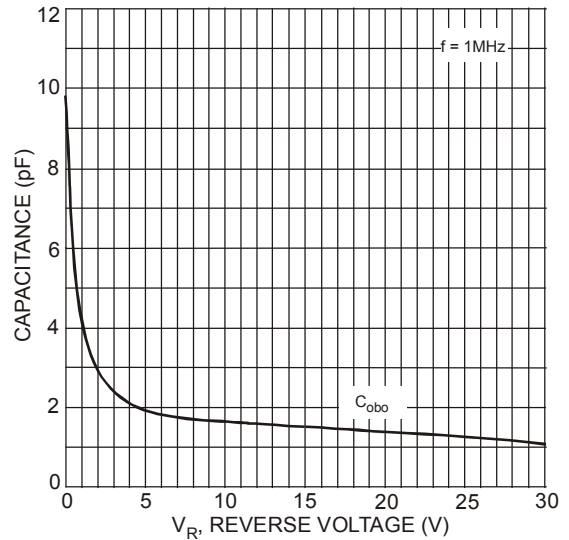

Fig.10 Typical Capacitance Characteristics

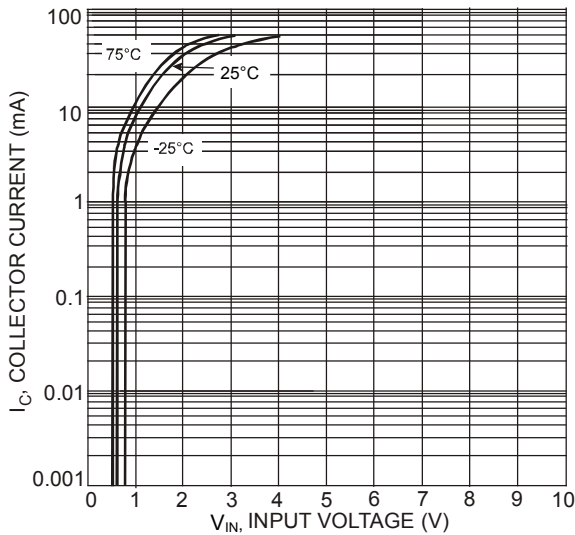

Fig.11 Collector Current vs. Input Voltage

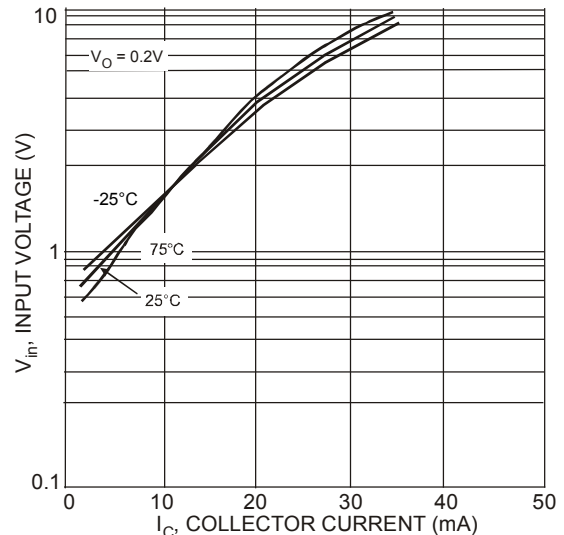
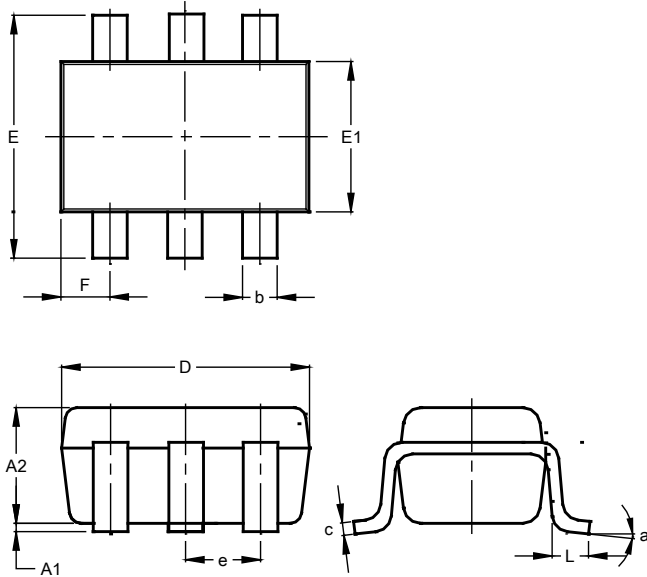

Fig.12 Input Voltage vs. Collector Current

Package Outline Dimensions

Please see <http://www.diodes.com/package-outlines.html> for the latest version.

SOT363



SOT363			
Dim	Min	Max	Typ
A1	0.00	0.10	0.05
A2	0.90	1.00	0.95
b	0.10	0.30	0.25
c	0.10	0.22	0.11
D	1.80	2.20	2.15
E	2.00	2.20	2.10
E1	1.15	1.35	1.30
e	0.650 BSC		
F	0.40	0.45	0.425
L	0.25	0.40	0.30
a	0°	8°	--
All Dimensions in mm			

Suggested Pad Layout

Please see <http://www.diodes.com/package-outlines.html> for the latest version.

SOT363

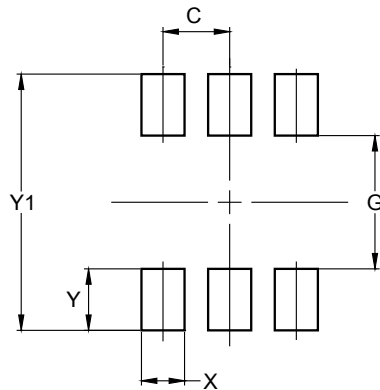

Dimensions	Value (in mm)
C	0.650
G	1.300
X	0.420
Y	0.600
Y1	2.500

IMPORTANT NOTICE



1. DIODES INCORPORATED AND ITS SUBSIDIARIES (“DIODES”) MAKE NO WARRANTY OF ANY KIND, EXPRESS OR IMPLIED, WITH REGARDS TO ANY INFORMATION CONTAINED IN THIS DOCUMENT, INCLUDING, BUT NOT LIMITED TO, THE IMPLIED WARRANTIES OF MERCHANTABILITY, FITNESS FOR A PARTICULAR PURPOSE OR NON-INFRINGEMENT OF THIRD PARTY INTELLECTUAL PROPERTY RIGHTS (AND THEIR EQUIVALENTS UNDER THE LAWS OF ANY JURISDICTION).
2. The Information contained herein is for informational purpose only and is provided only to illustrate the operation of Diodes products described herein and application examples. Diodes does not assume any liability arising out of the application or use of this document or any product described herein. This document is intended for skilled and technically trained engineering customers and users who design with Diodes products. Diodes products may be used to facilitate safety-related applications; however, in all instances customers and users are responsible for (a) selecting the appropriate Diodes products for their applications, (b) evaluating the suitability of the Diodes products for their intended applications, (c) ensuring their applications, which incorporate Diodes products, comply the applicable legal and regulatory requirements as well as safety and functional-safety related standards, and (d) ensuring they design with appropriate safeguards (including testing, validation, quality control techniques, redundancy, malfunction prevention, and appropriate treatment for aging degradation) to minimize the risks associated with their applications.
3. Diodes assumes no liability for any application-related information, support, assistance or feedback that may be provided by Diodes from time to time. Any customer or user of this document or products described herein will assume all risks and liabilities associated with such use, and will hold Diodes and all companies whose products are represented herein or on Diodes’ websites, harmless against all damages and liabilities.
4. Products described herein may be covered by one or more United States, international or foreign patents and pending patent applications. Product names and markings noted herein may also be covered by one or more United States, international or foreign trademarks and trademark applications. Diodes does not convey any license under any of its intellectual property rights or the rights of any third parties (including third parties whose products and services may be described in this document or on Diodes’ website) under this document.
5. Diodes products are provided subject to Diodes’ Standard Terms and Conditions of Sale (<https://www.diodes.com/about/company/terms-and-conditions/terms-and-conditions-of-sales/>) or other applicable terms. This document does not alter or expand the applicable warranties provided by Diodes. Diodes does not warrant or accept any liability whatsoever in respect of any products purchased through unauthorized sales channel.
6. Diodes products and technology may not be used for or incorporated into any products or systems whose manufacture, use or sale is prohibited under any applicable laws and regulations. Should customers or users use Diodes products in contravention of any applicable laws or regulations, or for any unintended or unauthorized application, customers and users will (a) be solely responsible for any damages, losses or penalties arising in connection therewith or as a result thereof, and (b) indemnify and hold Diodes and its representatives and agents harmless against any and all claims, damages, expenses, and attorney fees arising out of, directly or indirectly, any claim relating to any noncompliance with the applicable laws and regulations, as well as any unintended or unauthorized application.
7. While efforts have been made to ensure the information contained in this document is accurate, complete and current, it may contain technical inaccuracies, omissions and typographical errors. Diodes does not warrant that information contained in this document is error-free and Diodes is under no obligation to update or otherwise correct this information. Notwithstanding the foregoing, Diodes reserves the right to make modifications, enhancements, improvements, corrections or other changes without further notice to this document and any product described herein. This document is written in English but may be translated into multiple languages for reference. Only the English version of this document is the final and determinative format released by Diodes.
8. Any unauthorized copying, modification, distribution, transmission, display or other use of this document (or any portion hereof) is prohibited. Diodes assumes no responsibility for any losses incurred by the customers or users or any third parties arising from any such unauthorized use.

Copyright © 2021 Diodes Incorporated

www.diodes.com

Looking for pricing, stock, or lifecycle information?

Click below to explore more details on WIN SOURCE:

-  [View DDA124EUQ-13-F on WIN SOURCE](#)
-  [Diodes Incorporated Information](#)

Optimize Your Supply Chain with WIN SOURCE Solutions

-  Global Sourcing Solution
-  Obsolete Management
-  Cost Control Management
-  Shortage Management
-  Alternative Solution
-  Excess Inventory Management