

PTC thermistors for overcurrent protection in telecom applications

Telecom Pair Protector (TPP), SMD

Series/Type:

Date: March 2013

The following products presented in this data sheet are being withdrawn.

Ordering Code	Substitute Product	Date of Withdrawal	Deadline Last Orders	Last Shipments
B59875T1120A062	B59850T1120A062 or B59970T1100A062	2013-05-03	2014-06-01	2014-09-01
B59810T1120A062	B59805T1080A062 or B59510T1120A062	2013-05-03	2014-06-01	2014-09-01

For further information please contact your nearest EPCOS sales office, which will also support you in selecting a suitable substitute. The addresses of our worldwide sales network are presented at www.epcos.com/sales.

© EPCOS AG 2015. Reproduction, publication and dissemination of this publication, enclosures hereto and the information contained therein without EPCOS' prior express consent is prohibited.

EPCOS AG is a TDK Group Company.

Overcurrent protection for telecom

Telecom pair protector (TPP), SMD

SMD

Applications

- Overcurrent protection for telecom applications
- Suitable for line card applications e.g. POTS, access networks, customer premises equipment (CPE) or integrated voice data (IVD)

Internal circuit

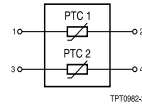

Features

- Two resistance-matched PTCs in a plastic housing
- Compliant with ITU-T standards
 - basic-level lightning surges (10/700 μ s)
 - basic-level power induction (600 V, 1 A, 0.2 s)
 - power contact criteria A/B (230 V, 15 min.)
- Compliant with GR-1089 AC power contact 120 V, 25 A, 15 min.
- Suitable for continuous connection to mains voltages of 110/230 V AC in tripped (high-ohmic) condition
- Housing material to UL94-V0
- UL approval to UL 1434 (file number E69802) for selected types
- Tight resistance matching maintained after switching
- Negligible resistance drift after reflow soldering or switching
- Marked with manufacturer's logo, type designation and date code
- RoHS-compatible

Options

- Alternative tolerances and resistances on request

Delivery mode

- T15**: Blister tape, 330-mm reel with 16-mm tape, taping to IEC 60286-3
- T17** and T18**: Blister tape, 380-mm reel with 24-mm tape, taping to IEC 60286-3

General technical data

Maximum fault voltage		$V_{F,max}$	245	V AC
Max. operating voltage		V_{max}	135	V AC
Operating temperature range	(V = 0)	T_{op}	-20/+125	°C
Operating temperature range	(V = V_{max})	T_{op}	0/+60	°C
Insulating test voltage between PTC1 and PTC2		V_{ins}	> 3	kV
Resistance matching in one housing	for $R_R \leq 4.75 \Omega$	$ R_2 - R_1 $	< 0.5	Ω
Resistance matching in one housing	for $R_R \leq 50 \Omega$	$ R_2 - R_1 $	< 1.0	Ω
Resistance matching in one housing	for $R_R = 75 \Omega$	$ R_2 - R_1 $	< 2.0	Ω

Overcurrent protection for telecom
Telecom pair protector (TPP), SMD
SMD
Electrical specifications and ordering codes

Type	R_R Ω	ΔR_R %	I_R @ 25 °C mA	I_R @ 70 °C mA	I_S @ 25 °C mA	I_{Smax} A	Approvals 	Ordering code
Component height max. 7.3								
T1535	35	+15/-20	110	70	230	2.5	–	B59535T1120A262
T1550	50	±15	90	60	190	2.5	–	B59550T1120A262
Component height max. 8.3								
T1509	9	±10	180	120	360	1.0	–	B59509T1120A062
T1510	10	±20	180	120	360	1.0	–	B59510T1120A062
T1525	25	±20	130	85	260	2.8	–	B59525T1120A062
Component height max. 10.5								
T1725	25	±20	130	85	260	2.8	–	B59725T1120A062
T1735	35	+15/-20	110	70	230	4.6	X	B59735T1120A062
T1750	50	±15	90	60	190	2.5	X	B59750T1120A062
Component height max. 11.5								
T1805	4.75	+15/-20	160	70	370	1.0	X	B59805T1080A062
T1810	10	±20	180	120	360	1.0	–	B59810T1120A062
T1825	25	±20	130	85	260	2.8	–	B59825T1120A062
T1835	35	+15/-20	110	70	230	4.6	X	B59835T1120A062
T1850	50	±15	90	60	190	2.5	X	B59850T1120A062
T1875	75	±20	70	40	150	2.5	X	B59875T1120A062

Overcurrent protection for telecom
Telecom pair protector (TPP), SMD
SMD
Switching times and ordering codes

Type	t_s (typ.) @ I_{Smax} s	t_s (typ.) @ 1 A s	t_s (typ.) @ 500 mA s	Ordering code
Component height max. 7.3				
T1535	0.07	0.4	1.6	B59535T1120A262
T1550	0.05	0.3	1.1	B59550T1120A262
Component height max. 8.3				
T1509	4	4	20	B59509T1120A062
T1510	3.6	3.6	16	B59510T1120A062
T1525	0.2	1.4	6	B59525T1120A062
Component height max. 10.5				
T1725	0.3	1.1	4	B59725T1120A062
T1735	0.04	0.8	3.4	B59735T1120A062
T1750	0.1	0.6	2.4	B59750T1120A062
Component height max. 11.5				
T1805	4	4	20	B59805T1080A062
T1810	3.8	3.8	19.0	B59810T1120A062
T1825	0.2	1.5	6.5	B59825T1120A062
T1835	0.06	1.1	4.5	B59835T1120A062
T1850	0.13	0.8	3.1	B59850T1120A062
T1875	0.12	0.7	2.6	B59875T1120A062

Overcurrent protection for telecom

Telecom pair protector (TPP), SMD

SMD

Internal circuit

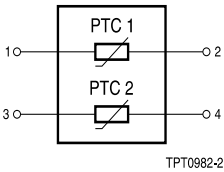

Dimensional drawings in mm

For type T1509, T1510 and T1525

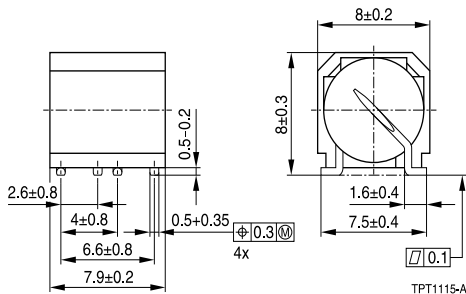

Solder pad

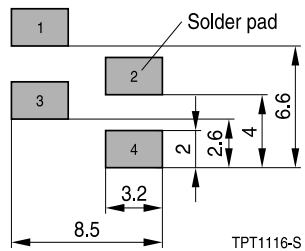

For type T1535 and T1550

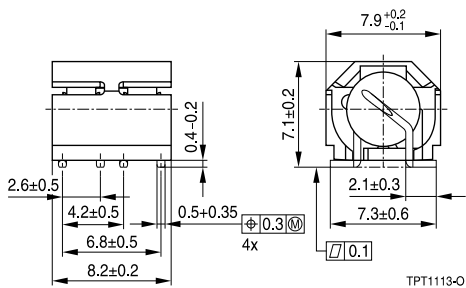

Solder pad

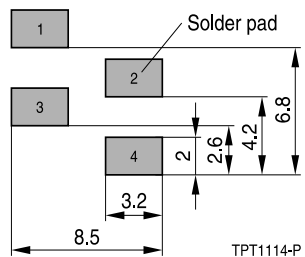

Overcurrent protection for telecom

Telecom pair protector (TPP), SMD

SMD

Dimensional drawings in mm

For type T1725, T1735, T1750

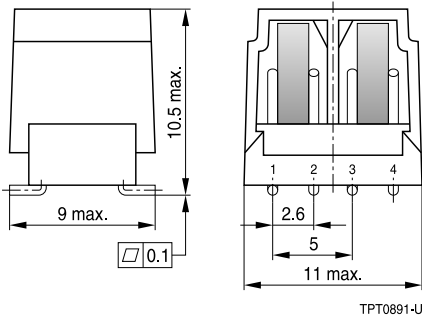

Solder pad

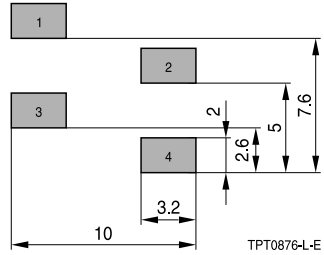

For type T1805 ... T1875

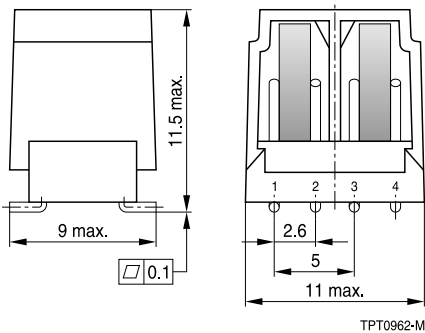

Solder pad

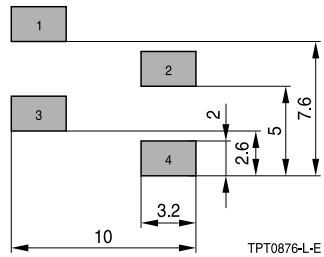

Overcurrent protection for telecom
Telecom pair protector (TPP), SMD
SMD
Reliability data

Test	Standard	Test conditions	$ \Delta R_{25}/R_{25} $
Electrical endurance, cycling	IEC 60738-1	Room temperature, $I_{Smax}; V_{max}$ Number of cycles: 10	< 20%
Electrical endurance, constant	IEC 60738-1	Storage at $V_{max}/T_{op,max}$ (V_{max}) Test duration: 1000 h	< 25%
Damp heat	IEC 60738-1	Temperature of air: 40 °C Relative humidity of air: 93% Duration: 56 days Test according to IEC 60068-2-78	< 10%
Rapid change of temperature	IEC 60738-1	$T_1 = T_{op,min}$ (0 V), $T_2 = T_{op,max}$ (0 V) Number of cycles: 5 Test duration: 30 min Test according to IEC 60068-2-14, test Na	< 10%
Vibration	IEC 60738-1	Frequency range: 10 to 55 Hz Displacement amplitude: 0.75 mm Test duration: 3 × 2 h Test according to IEC 60068-2-6, test Fc	< 5%
Shock	IEC 60738-1	Acceleration: 390 m/s ² Pulse duration: 6 ms; 6 × 4000 pulses	< 5%
Climatic sequence	IEC 60738-1	Dry heat: $T = T_{op,max}$ (0 V) Test duration: 16 h Damp heat first cycle Cold: $T = T_{op,min}$ (0 V) Test duration: 2 h Damp heat 5 cycles Tests performed according to IEC 60068-2-30	< 10%

Overcurrent protection for telecom

Telecom pair protector (TPP), SMD

SMD

ITU performance overview and fault conditions

	Test no.	ITU K20		ITU K21		ITU K45	
		Basic test level	Enhanced test level	Basic test level	Enhanced test level	Basic test level	Enhanced test level
Power induction	1	A	A	A	A	A	A
	2	B	C	B	C	B	C
Power contact	3	D	E	D	E	D	E
Lightning surge	4	F	G	G	G	G	G
	5	H	H	H	I	H	H

Power induction	A	600 V AC, R = 600 Ω, t = 0.2 s, criteria A
	B	600 V AC, R = 600 Ω, t = 1.0 s, with GDT, criteria A
	C	1500 V AC, R = 200 Ω, t = 2.0 s, with GDT, criteria A
Power contact	D	230 V AC, t = 15 min, R = 10 ... 1000 Ω, criteria B
	E	230 V AC, t = 15 min, R = 10, 20, 40, 80, 1000 Ω, criteria B, R = 160, 300, 600 Ω, criteria A
Lightning surge	F	$V_{c(max)} = 1.0$ kV, R = 25 Ω, t = 10/700 μs, without GDT, criteria A
	G	$V_{c(max)} = 1.5$ kV, R = 25 Ω, t = 10/700 μs, without GDT, criteria A
	H	$V_{c(max)} = 4.0$ kV, R = 25 Ω, t = 10/700 μs, with GDT, criteria A
	I	$V_{c(max)} = 6.0$ kV, R = 25 Ω, t = 10/700 μs, with GDT, criteria A

Criteria A: no damage, function must be fulfilled.

Criteria B: no fire hazard.

Electrical requirements according to GR-1089 standard for AC power contact

AC voltage: 120 V, 50 Hz, short circuit current 25 A, time 15 min, criteria A.

Overcurrent protection for telecom

Telecom pair protector (TPP), SMD

SMD

Cautions and warnings

General

- EPCOS thermistors are designed for specific applications and should not be used for purposes not identified in our specifications, application notes and data books unless otherwise agreed with EPCOS during the design-in-phase.
- Ensure suitability of thermistor through reliability testing during the design-in phase. The thermistors should be evaluated taking into consideration worst-case conditions.

Storage

- Store thermistors only in original packaging. Do not open the package before storage.
- Storage conditions in original packaging: storage temperature $-25\text{ }^{\circ}\text{C}$... $+45\text{ }^{\circ}\text{C}$, relative humidity $\leq 75\%$ annual mean, maximum 95%, dew precipitation is inadmissible.
- Avoid contamination of thermistors surface during storage, handling and processing.
- Avoid storage of thermistor in harmful environment with effect on function on long-term operation (examples given under operation precautions).
- Use thermistor within the following period after delivery:
 - Through-hole devices (housed and leaded PTCs): 24 months
 - Motor protection sensors, glass-encapsulated sensors and probe assemblies: 24 months
 - Telecom pair and quattro protectors (TPP, TQP): 24 months
 - Leadless PTC thermistors for pressure contacting: 12 months
 - Leadless PTC thermistors for soldering: 6 months
 - SMDs in EIA sizes 3225 and 4032, and for PTCs with metal tags: 24 months
 - SMDs in EIA sizes 0402, 0603, 0805 and 1210: 12 months

Handling

- PTCs must not be dropped. Chip-offs must not be caused during handling of PTCs.
- Components must not be touched with bare hands. Gloves are recommended.
- Avoid contamination of thermistor surface during handling.

Soldering (where applicable)

- Use rosin-type flux or non-activated flux.
- Insufficient preheating may cause ceramic cracks.
- Rapid cooling by dipping in solvent is not recommended.
- Complete removal of flux is recommended.
- Standard PTC heaters are not suitable for soldering.

Overcurrent protection for telecom

Telecom pair protector (TPP), SMD

SMD

Mounting

- Electrode must not be scratched before/during/after the mounting process.
- Contacts and housing used for assembly with thermistor have to be clean before mounting. Especially grease or oil must be removed.
- When PTC thermistors are encapsulated with sealing material, the precautions given in chapter "Mounting instructions", "Sealing and potting" must be observed.
- When the thermistor is mounted, there must not be any foreign body between the electrode of the thermistor and the clamping contact.
- The minimum force of the clamping contacts pressing against the PTC must be 10 N.
- During operation, the thermistor's surface temperature can be very high. Ensure that adjacent components are placed at a sufficient distance from the thermistor to allow for proper cooling at the thermistors.
- Ensure that adjacent materials are designed for operation at temperatures comparable to the surface temperature of thermistor. Be sure that surrounding parts and materials can withstand this temperature.
- Avoid contamination of thermistor surface during processing.

Operation

- Use thermistors only within the specified temperature operating range.
- Use thermistors only within the specified voltage and current ranges.
- Environmental conditions must not harm the thermistors. Use thermistors only in normal atmospheric conditions. Avoid use in deoxidizing gases (chlorine gas, hydrogen sulfide gas, ammonia gas, sulfuric acid gas etc), corrosive agents, humid or salty conditions. Contact with any liquids and solvents should be prevented.
- Be sure to provide an appropriate fail-safe function to prevent secondary product damage caused by abnormal function (e.g. use VDR for limitation of overvoltage condition).

This listing does not claim to be complete, but merely reflects the experience of EPCOS AG.

Overcurrent protection for telecom

Telecom pair protector (TPP), SMD

SMD

Symbols and terms

A	Area
C	Capacitance
C_{th}	Heat capacity
f	Frequency
I	Current
I_{max}	Maximum current
I_R	Rated current
I_{res}	Residual current
I_{PTC}	PTC current
I_r	Residual current
$I_{r,oil}$	Residual current in oil (for level sensors)
$I_{r,air}$	Residual current in air (for level sensors)
I_{RMS}	Root-mean-square value of current
I_S	Switching current
I_{Smax}	Maximum switching current
LCT	Lower category temperature
N	Number (integer)
N_c	Operating cycles at V_{max} , charging of capacitor
N_f	Switching cycles at V_{max} , failure mode
P	Power
P_{25}	Maximum power at 25 °C
P_{el}	Electrical power
P_{diss}	Dissipation power
R_G	Generator internal resistance
R_{min}	Minimum resistance
R_R	Rated resistance
ΔR_R	Tolerance of R_R
R_P	Parallel resistance
R_{PTC}	PTC resistance
R_{ref}	Reference resistance
R_S	Series resistance
R_{25}	Resistance at 25 °C
$R_{25,match}$	Resistance matching per reel/ packing unit at 25 °C
ΔR_{25}	Tolerance of R_{25}
T	Temperature
t	Time
T_A	Ambient temperature
t_a	Thermal threshold time

Overcurrent protection for telecom

Telecom pair protector (TPP), SMD

SMD

T_C	Ferroelectric Curie temperature
t_E	Settling time (for level sensors)
T_R	Rated temperature
T_{sense}	Sensing temperature
T_{op}	Operating temperature
T_{PTC}	PTC temperature
t_R	Response time
T_{ref}	Reference temperature
T_{Rmin}	Temperature at minimum resistance
t_S	Switching time
T_{surf}	Surface temperature
UCT	Upper category temperature
V or V_{el}	Voltage (with subscript only for distinction from volume)
$V_{c(max)}$	Maximum DC charge voltage of the surge generator
$V_{F,max}$	Maximum voltage applied at fault conditions in protection mode
V_{RMS}	Root-mean-square value of voltage
V_{BD}	Breakdown voltage
V_{ins}	Insulation test voltage
$V_{link,max}$	Maximum link voltage
V_{max}	Maximum operating voltage
$V_{max,dyn}$	Maximum dynamic (short-time) operating voltage
V_{meas}	Measuring voltage
$V_{meas,max}$	Maximum measuring voltage
V_R	Rated voltage
V_{PTC}	Voltage drop across a PTC thermistor
α	Temperature coefficient
Δ	Tolerance, change
δ_{th}	Dissipation factor
τ_{th}	Thermal cooling time constant
λ	Failure rate
e	Lead spacing (in mm)

Abbreviations / Notes

SMD Surface-mount devices

* To be replaced by a number in ordering codes, type designations etc.

+ To be replaced by a letter

All dimensions are given in mm.

The commas used in numerical values denote decimal points.

Important notes



The following applies to all products named in this publication:

1. Some parts of this publication contain **statements about the suitability of our products for certain areas of application**. These statements are based on our knowledge of typical requirements that are often placed on our products in the areas of application concerned. We nevertheless expressly point out **that such statements cannot be regarded as binding statements about the suitability of our products for a particular customer application**. As a rule we are either unfamiliar with individual customer applications or less familiar with them than the customers themselves. For these reasons, it is always ultimately incumbent on the customer to check and decide whether a product with the properties described in the product specification is suitable for use in a particular customer application.
2. We also point out that **in individual cases, a malfunction of electronic components or failure before the end of their usual service life cannot be completely ruled out in the current state of the art, even if they are operated as specified**. In customer applications requiring a very high level of operational safety and especially in customer applications in which the malfunction or failure of an electronic component could endanger human life or health (e.g. in accident prevention or life-saving systems), it must therefore be ensured by means of suitable design of the customer application or other action taken by the customer (e.g. installation of protective circuitry or redundancy) that no injury or damage is sustained by third parties in the event of malfunction or failure of an electronic component.
3. **The warnings, cautions and product-specific notes must be observed.**
4. In order to satisfy certain technical requirements, **some of the products described in this publication may contain substances subject to restrictions in certain jurisdictions (e.g. because they are classed as hazardous)**. Useful information on this will be found in our Material Data Sheets on the Internet (www.tdk-electronics.tdk.com/material). Should you have any more detailed questions, please contact our sales offices.
5. We constantly strive to improve our products. Consequently, **the products described in this publication may change from time to time**. The same is true of the corresponding product specifications. Please check therefore to what extent product descriptions and specifications contained in this publication are still applicable before or when you place an order.







We also **reserve the right to discontinue production and delivery of products**. Consequently, we cannot guarantee that all products named in this publication will always be available. The aforementioned does not apply in the case of individual agreements deviating from the foregoing for customer-specific products.
6. Unless otherwise agreed in individual contracts, **all orders are subject to our General Terms and Conditions of Supply**.
7. **Our manufacturing sites serving the automotive business apply the IATF 16949 standard**. The IATF certifications confirm our compliance with requirements regarding the quality management system in the automotive industry. Referring to customer requirements and customer specific requirements ("CSR") TDK always has and will continue to have the policy of respecting individual agreements. Even if IATF 16949 may appear to support the acceptance of unilateral requirements, we hereby like to emphasize that **only requirements mutually agreed upon can and will be implemented in our Quality Management System**. For clarification purposes we like to point out that obligations from IATF 16949 shall only become legally binding if individually agreed upon.
8. The trade names EPCOS, CeraCharge, CeraDiode, CeraLink, CeraPad, CeraPlas, CSMP, CTVS, DeltaCap, DigiSiMic, ExoCore, FilterCap, FormFit, LeaXield, MiniBlue, MiniCell, MKD, MKK, MotorCap, PCC, PhaseCap, PhaseCube, PhaseMod, PhiCap, PowerHap, PQSine, PQvar, SIFERRIT, SIFI, SIKOREL, SilverCap, SIMDAD, SiMic, SIMID, SineFormer, SIOV, ThermoFuse, WindCap are **trademarks registered or pending** in Europe and in other countries. Further information will be found on the Internet at www.tdk-electronics.tdk.com/trademarks.

Looking for pricing, stock, or lifecycle information?

Click below to explore more details on WIN SOURCE:

-  [View B59550T1120A262 on WIN SOURCE](#)
-  [EPCOS \(TDK\) Information](#)

Optimize Your Supply Chain with WIN SOURCE Solutions

-  Global Sourcing Solution
-  Obsolete Management
-  Cost Control Management
-  Shortage Management
-  Alternative Solution
-  Excess Inventory Management