

PTC thermistors

Series/Type: D901

The following products presented in this data sheet are being withdrawn.

Ordering Code	Substitute Product	Date of Withdrawal	Deadline Last Orders	Last Shipments
B59901D0120A040	B59052D1120A040	2019-03-01	2019-06-07	2019-09-07
B59901D0110A040	B59052D1110A040	2019-03-01	2019-06-07	2019-09-07
B59901D0100A040	B59052D1100A040	2019-03-01	2019-06-07	2019-09-07



Ordering Code	Substitute Product	Date of Withdrawal	Deadline Last Orders	Last Shipments
B59901D0090A040	B59052D1090A040	2019-03-01	2019-06-07	2019-09-07
B59901D0080A040	B59052D1080A040	2019-03-01	2019-06-07	2019-09-07
B59901D0070A040	B59052D1070A040	2019-03-01	2019-06-07	2019-09-07
B59901D0060A040	B59052D1060A040	2019-03-01	2019-06-07	2019-09-07

Please contact your nearest TDK sales office if you need support in selecting a suitable substitute. The addresses of our worldwide sales network are presented at www.tdk-electronics.tdk.com/sales.

Sensors

Limit temperature sensors, probe assemblies

D901, D1052

Applications

- Limit temperature sensor

Features

- Sensor with epoxy resin coating
- Tinned leads
- Metal tag for easy mounting
- Characteristics for sensing temperatures
 $T_{\text{sense}} = 90$ to 120 °C conform with DIN 44081
- Metal tag permits good thermal coupling and thus short response time
- Marking type D1052: Type, manufacturer's logo, T_{sense} temperature in °C and date code YYWW
- Marking type D901: Three digits stamped on to identify T_{sense}
- RoHS-compatible

Delivery mode

- Type D1052: Cardboard strips with hot-melt adhesive tape in cardboard box (800 pcs.)
- Type D901: Cardboard strips with manila paper strips in cardboard box (500 pcs.)

Dimensional drawings

Type D1052

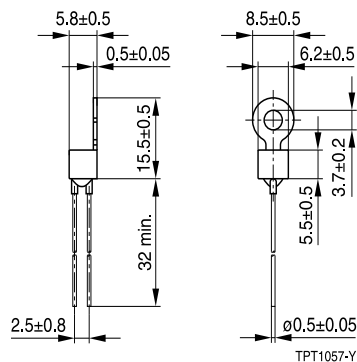

Type D901

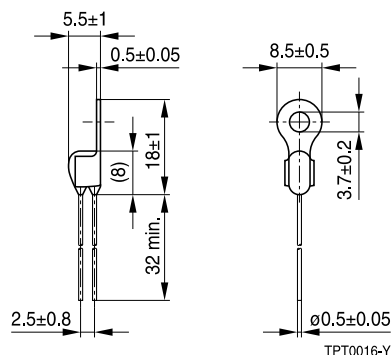

Dimensions in mm

General technical data

Max. operating voltage	($T_A = 0 \dots 40$ °C)	V_{max}	30	V DC
Measuring voltage ¹⁾	($T_A = -40$ °C ... $T_{\text{sense}} + 5$ K)	V_{meas}	≤ 2.5	V DC
Max. measuring voltage ¹⁾	For T_A see table "Electrical specifications"	$V_{\text{meas,max}}$	7.5	V DC
Rated resistance	($V_{\text{PTC}} \leq 2.5$ V)	R_R	≤ 100	Ω
Insulating test voltage	(between tags and leads)	V_{ins}	500	V AC
Operating temperature range	($V \leq V_{\text{meas,max}}$)	T_{op}	$-40/ T_{\text{sense}} + 23$	°C
Operating temperature range	($V = V_{\text{max}}$)	T_{op}	0/+40	°C

1) V_{meas} and $V_{\text{meas,max}}$ for 90 °C $\leq T_{\text{sense}} \leq 120$ °C acc. to DIN 44081.

Sensors
Limit temperature sensors, probe assemblies
D901, D1052
Electrical specifications and ordering codes

T_{sense}	R ($T_{\text{sense}} - 5 \text{ K}$) ($V_{\text{PTC}} \leq 2.5 \text{ V}$)	R ($T_{\text{sense}} + 5 \text{ K}$) ($V_{\text{PTC}} \leq 2.5 \text{ V}$)	R ($T_{\text{sense}} + 15 \text{ K}$) ($V_{\text{PTC}} \leq 7.5 \text{ V}$)	R ($T_{\text{sense}} + 23 \text{ K}$) ($V_{\text{PTC}} \leq 7.5 \text{ V}$)	Stamp code	Ordering code
$^{\circ}\text{C}$	Ω	Ω	Ω	Ω		
Type D1052						
60	≤ 570	≥ 570	-	$\geq 10 \text{ k}$	-	B59052D1060A040
70	≤ 570	≥ 570	-	$\geq 10 \text{ k}$	-	B59052D1070A040
80	≤ 570	≥ 570	-	$\geq 10 \text{ k}$	-	B59052D1080A040
90	≤ 550	≥ 1330	$\geq 4 \text{ k}$	-	-	B59052D1090A040
Type D901						
60	≤ 570	≥ 570	-	$\geq 10 \text{ k}$	331	B59901D0060A040
70	≤ 570	≥ 570	-	$\geq 10 \text{ k}$	341	B59901D0070A040
80	≤ 570	≥ 570	-	$\geq 10 \text{ k}$	351	B59901D0080A040
90	≤ 550	≥ 1330	$\geq 4 \text{ k}$	-	361	B59901D0090A040
100	≤ 550	≥ 1330	$\geq 4 \text{ k}$	-	371	B59901D0100A040
110	≤ 550	≥ 1330	$\geq 4 \text{ k}$	-	381	B59901D0110A040
120	≤ 550	≥ 1330	$\geq 4 \text{ k}$	-	391	B59901D0120A040

Reliability data

Test	Standard	Test conditions	$ \Delta R_{25}/R_{25} $
Electrical endurance, constant	IEC 60738-1	Storage at V_{max} and $T_{\text{op,max}}$ (@ V_{max}) Test duration: 1000 h	< 25%
Damp heat	IEC 60738-1	Temperature of air: 40 $^{\circ}\text{C}$ Relative humidity of air: 93% Duration: 56 days Test according to IEC 60068-2-78	< 10%
Rapid change of temperature	IEC 60738-1	$T_1 = T_{\text{op,min}}$ (0 V), $T_2 = T_{\text{op,max}}$ (0 V) Number of cycles: 5 Test duration: 30 min Test according to IEC 60068-2-14, test Na	< 25%
Vibration	IEC 60738-1	Frequency range: 10 to 55 Hz Displacement amplitude: 0.75 mm Test duration: 3 \times 2 h Test according to IEC 60068-2-6, test Fc	< 5%

Characteristics (typical) for type D1052

PTC resistance R_{PTC} versus

PTC temperature T_{PTC} (measured at low signal voltage)

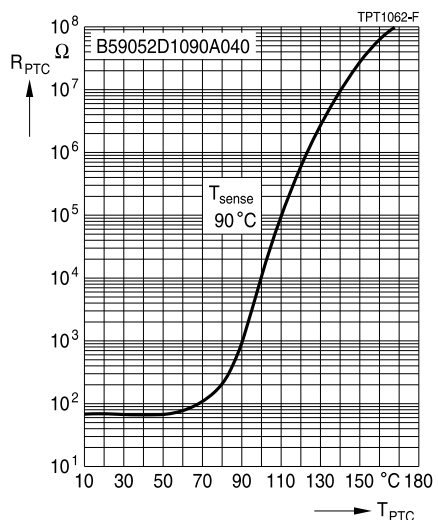
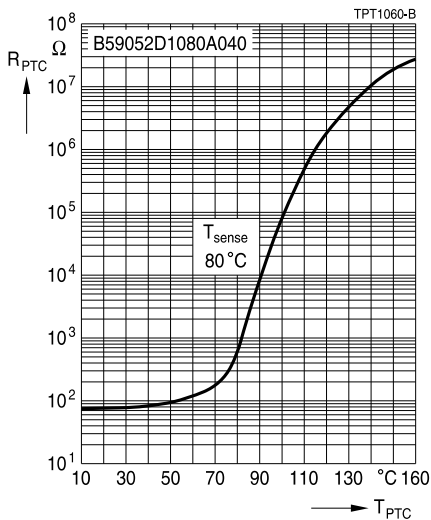
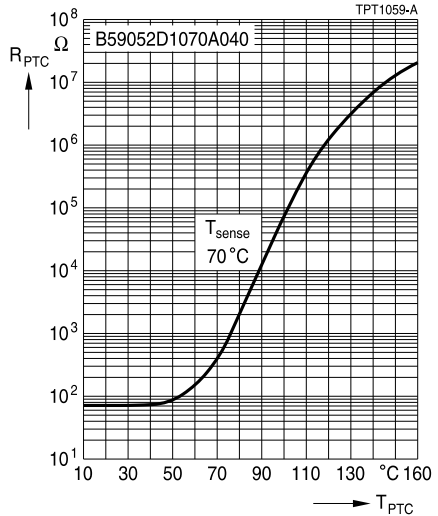
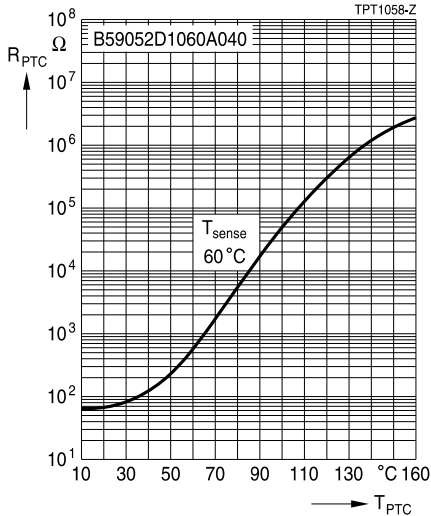

Characteristics (typical) for type D901

PTC resistance R_{PTC} versus

PTC temperature T_{PTC} (measured at low signal voltage)

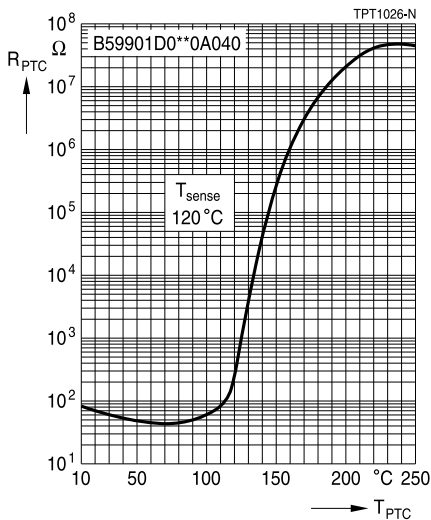
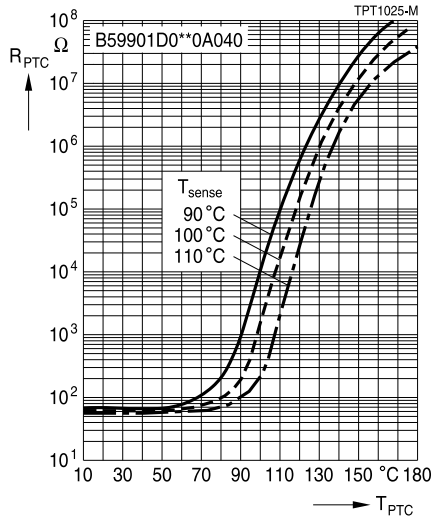
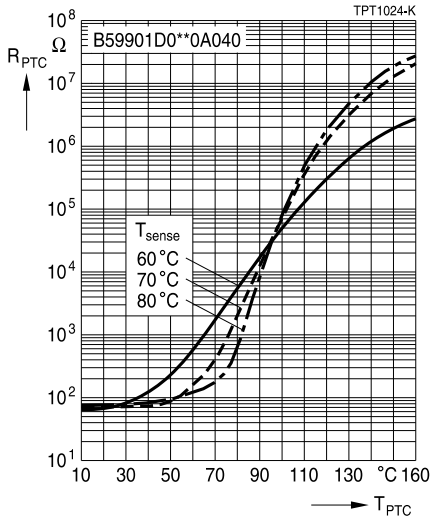

Cautions and warnings

General

- EPCOS thermistors are designed for specific applications and should not be used for purposes not identified in our specifications, application notes and data books unless otherwise agreed with EPCOS during the design-in-phase.
- Ensure suitability of thermistor through reliability testing during the design-in phase. The thermistors should be evaluated taking into consideration worst-case conditions.

Storage

- Store thermistors only in original packaging. Do not open the package prior to processing.
- Storage conditions in original packaging: storage temperature $-25\text{ }^{\circ}\text{C} \dots +45\text{ }^{\circ}\text{C}$, relative humidity $\leq 75\%$ annual mean, maximum 95%, dew precipitation is inadmissible.
- Avoid contamination of thermistors surface during storage, handling and processing.
- Avoid storage of thermistor in harmful environment with effect on function on long-term operation (examples given under operation precautions).
- Use thermistor within the following period after delivery:
 - Through-hole devices (housed and leaded PTCs): 24 months
 - Motor protection sensors, glass-encapsulated sensors and probe assemblies: 24 months
 - Telecom pair and quattro protectors (TPP, TQP): 24 months
 - Leadless PTC thermistors for pressure contacting: 12 months
 - Leadless PTC thermistors for soldering: 6 months
 - SMDs in EIA sizes 3225 and 4032, and for PTCs with metal tags: 24 months
 - SMDs in EIA sizes 1210 and smaller: 12 months

Handling

- PTCs must not be dropped. Chip-offs must not be caused during handling of PTCs.
- The ceramic and metallization of the components must not be touched with bare hands. Gloves are recommended.
- Avoid contamination of thermistor surface during handling.

Soldering (where applicable)

- Use rosin-type flux or non-activated flux.
- Insufficient preheating may cause ceramic cracks.
- Rapid cooling by dipping in solvent is not recommended.
- Complete removal of flux is recommended.
- Standard PTC heaters are not suitable for soldering.

Mounting

- Electrode must not be scratched before/during/after the mounting process.
- Contacts and housing used for assembly with thermistor have to be clean before mounting. Especially grease or oil must be removed.
- When PTC thermistors are encapsulated with sealing material, the precautions given in chapter "Mounting instructions", "Sealing and potting" must be observed.
- When the thermistor is mounted, there must not be any foreign body between the electrode of the thermistor and the clamping contact.
- The minimum force and pressure of the clamping contacts pressing against the PTC must be 10 N and 50 kPa, respectively. In case the assembly is exposed to mechanical shock and/ or vibration this force should be higher in order to avoid movement of the PTC during operation.
- During operation, the thermistor's surface temperature can be very high. Ensure that adjacent components are placed at a sufficient distance from the thermistor to allow for proper cooling at the thermistors.
- Ensure that adjacent materials are designed for operation at temperatures comparable to the surface temperature of thermistor. Be sure that surrounding parts and materials can withstand this temperature.
- Avoid contamination of thermistor surface during processing.

Operation

- Use thermistors only within the specified temperature operating range.
- Use thermistors only within the specified voltage and current ranges.
- Environmental conditions must not harm the thermistors. Use thermistors only in normal atmospheric conditions. Avoid use in deoxidizing gases (chlorine gas, hydrogen sulfide gas, ammonia gas, sulfuric acid gas etc), corrosive agents, humid or salty conditions. Contact with any liquids and solvents should be prevented.
- Be sure to provide an appropriate fail-safe function to prevent secondary product damage caused by abnormal function (e.g. use VDR for limitation of overvoltage condition).

This listing does not claim to be complete, but merely reflects the experience of EPCOS AG.

Display of ordering codes for EPCOS products

The ordering code for one and the same EPCOS product can be represented differently in data sheets, data books, other publications, on the EPCOS website, or in order-related documents such as shipping notes, order confirmations and product labels. **The varying representations of the ordering codes are due to different processes employed and do not affect the specifications of the respective products.** Detailed information can be found on the Internet under www.epcos.com/orderingcodes

Symbols and terms

Symbol	Term
A	Area
C	Capacitance
C_{th}	Heat capacity
f	Frequency
I	Current
I_{max}	Maximum current
I_R	Rated current
I_{res}	Residual current
I_{PTC}	PTC current
I_r	Residual current
$I_{r,oil}$	Residual current in oil (for level sensors)
$I_{r,air}$	Residual current in air (for level sensors)
I_{RMS}	Root-mean-square value of current
I_S	Switching current
I_{Smax}	Maximum switching current
LCT	Lower category temperature
N	Number (integer)
N_c	Operating cycles at V_{max} , charging of capacitor
N_f	Switching cycles at V_{max} , failure mode
P	Power
P_{25}	Maximum power at 25 °C
P_{el}	Electrical power
P_{diss}	Dissipation power
R_G	Generator internal resistance
R_{min}	Minimum resistance
R_R	Rated resistance @ rated temperature T_R
ΔR_R	Tolerance of R_R
R_P	Parallel resistance
R_{PTC}	PTC resistance
R_{ref}	Reference resistance
R_S	Series resistance
R_{25}	Resistance at 25 °C
$R_{25,match}$	Resistance matching per reel/ packing unit at 25 °C
ΔR_{25}	Tolerance of R_{25}

Sensors
Limit temperature sensors, probe assemblies
D901, D1052

T	Temperature
t	Time
T _A	Ambient temperature
t _a	Thermal threshold time
T _C	Ferroelectric Curie temperature
t _E	Settling time (for level sensors)
T _R	Rated temperature @ 25 °C or otherwise specified in the data sheet
T _{sense}	Sensing temperature
T _{op}	Operating temperature
T _{PTC}	PTC temperature
t _R	Response time
T _{ref}	Reference temperature
T _{Rmin}	Temperature at minimum resistance
t _S	Switching time
T _{surf}	Surface temperature
UCT	Upper category temperature
V or V _{el}	Voltage (with subscript only for distinction from volume)
V _{c(max)}	Maximum DC charge voltage of the surge generator
V _{F,max}	Maximum voltage applied at fault conditions in protection mode
V _{RMS}	Root-mean-square value of voltage
V _{BD}	Breakdown voltage
V _{ins}	Insulation test voltage
V _{link,max}	Maximum link voltage
V _{max}	Maximum operating voltage
V _{max,dyn}	Maximum dynamic (short-time) operating voltage
V _{meas}	Measuring voltage
V _{meas,max}	Maximum measuring voltage
V _R	Rated voltage
V _{PTC}	Voltage drop across a PTC thermistor
α	Temperature coefficient
Δ	Tolerance, change
δ _{th}	Dissipation factor
τ _{th}	Thermal cooling time constant
λ	Failure rate
	Lead spacing (in mm)

Important notes

The following applies to all products named in this publication:

1. Some parts of this publication contain **statements about the suitability of our products for certain areas of application**. These statements are based on our knowledge of typical requirements that are often placed on our products in the areas of application concerned. We nevertheless expressly point out **that such statements cannot be regarded as binding statements about the suitability of our products for a particular customer application**. As a rule we are either unfamiliar with individual customer applications or less familiar with them than the customers themselves. For these reasons, it is always ultimately incumbent on the customer to check and decide whether a product with the properties described in the product specification is suitable for use in a particular customer application.
2. We also point out that **in individual cases, a malfunction of electronic components or failure before the end of their usual service life cannot be completely ruled out in the current state of the art, even if they are operated as specified**. In customer applications requiring a very high level of operational safety and especially in customer applications in which the malfunction or failure of an electronic component could endanger human life or health (e.g. in accident prevention or life-saving systems), it must therefore be ensured by means of suitable design of the customer application or other action taken by the customer (e.g. installation of protective circuitry or redundancy) that no injury or damage is sustained by third parties in the event of malfunction or failure of an electronic component.
3. **The warnings, cautions and product-specific notes must be observed.**
4. In order to satisfy certain technical requirements, **some of the products described in this publication may contain substances subject to restrictions in certain jurisdictions (e.g. because they are classed as hazardous)**. Useful information on this will be found in our Material Data Sheets on the Internet (www.tdk-electronics.tdk.com/material). Should you have any more detailed questions, please contact our sales offices.
5. We constantly strive to improve our products. Consequently, **the products described in this publication may change from time to time**. The same is true of the corresponding product specifications. Please check therefore to what extent product descriptions and specifications contained in this publication are still applicable before or when you place an order.

We also **reserve the right to discontinue production and delivery of products**. Consequently, we cannot guarantee that all products named in this publication will always be available. The aforementioned does not apply in the case of individual agreements deviating from the foregoing for customer-specific products.
6. Unless otherwise agreed in individual contracts, **all orders are subject to our General Terms and Conditions of Supply**.
7. **Our manufacturing sites serving the automotive business apply the IATF 16949 standard**. The IATF certifications confirm our compliance with requirements regarding the quality management system in the automotive industry. Referring to customer requirements and customer specific requirements ("CSR") TDK always has and will continue to have the policy of respecting individual agreements. Even if IATF 16949 may appear to support the acceptance of unilateral requirements, we hereby like to emphasize that **only requirements mutually agreed upon can and will be implemented in our Quality Management System**. For clarification purposes we like to point out that obligations from IATF 16949 shall only become legally binding if individually agreed upon.



Important notes

8. The trade names EPCOS, CeraCharge, CeraDiode, CeraLink, CeraPad, CeraPlas, CSMP, CTVS, DeltaCap, DigiSiMic, ExoCore, FilterCap, FormFit, LeaXield, MiniBlue, MiniCell, MKD, MKK, MotorCap, PCC, PhaseCap, PhaseCube, PhaseMod, PhiCap, PowerHap, PQSine, PQvar, SIFERRIT, SIFI, SIKOREL, SilverCap, SIMDAD, SiMic, SIMID, SineFormer, SIOV, ThermoFuse, WindCap are **trademarks registered or pending** in Europe and in other countries. Further information will be found on the Internet at www.tdk-electronics.tdk.com/trademarks.







Release 2018-10

Looking for pricing, stock, or lifecycle information?

Click below to explore more details on WIN SOURCE:

-  [View B59901D0100A040 on WIN SOURCE](#)
-  [EPCOS \(TDK\) Information](#)

Optimize Your Supply Chain with WIN SOURCE Solutions

-  Global Sourcing Solution
-  Obsolete Management
-  Cost Control Management
-  Shortage Management
-  Alternative Solution
-  Excess Inventory Management