



**THE DATASHEET OF  
RT7738GGE**



# SmartJitter™ Multi-Mode Flyback Controller

## General Description

The RT7738 series are enhanced high efficient multi-mode PWM flyback controller with proprietary SmartJitter™ technology. The innovative SmartJitter™ technology can not only reduces the EMI emissions of SMPS when the system enters green mode, but also eliminates the output jittering ripple. Also, the RT7738 series feature Continuous Conduction Mode (CCM) and valley switching multi-mode control to optimize the product performance. To meet the stringent trend toward performance in recent years, the RT7738 series are the best choice for product designers.

The RT7738 is available in SOT-23-6 package, and it is a current mode PWM controller. Comprehensive protection and programmable functions are built-in, including a programmable propagation delay time compensation, a programmable output Over-Voltage Protection (OVP), a programmable external Over-Temperature Protection (OTP), and a programmable bulk capacitor Brown-in/Brown-out protection. With the above features, the RT7738 is a cost-effective and compact solution for AC-DC products.

## Features

- Proprietary SmartJitter™ Technology
  - ▶ Reducing EMI Emissions of SMPS
  - ▶ Output Jittering Ripple Elimination
- Continuous Conduction Mode (CCM) and Valley Switching Mode Control
- Ultra-low Start-up current (<3μA)
- Accurate Over-Load Protection (OLP)
- Programmable Propagation Delay Time Compensation
- Programmable Output Over-Voltage Protection
- Programmable External Over-Temperature Protection
- Programmable Bulk Capacitor Brown-in/Brown-out Protection
- Driver Capability : 200mA/–300mA
- High Noise Immunity

## Applications

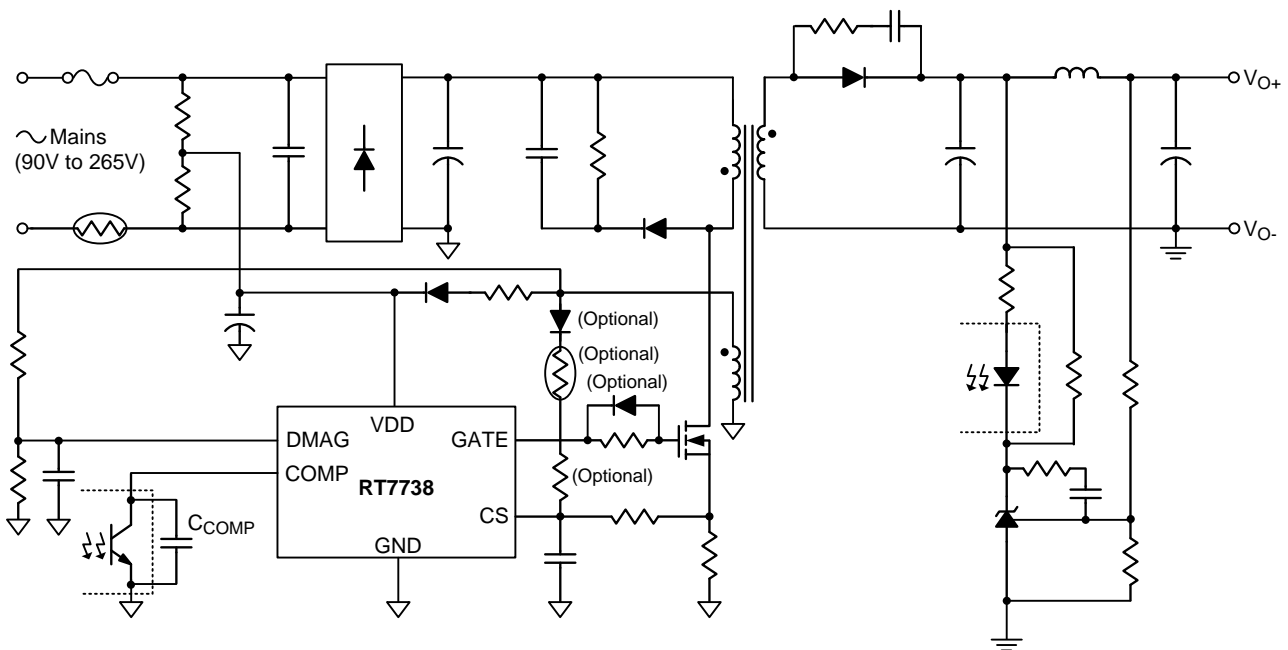

- Switching AC-DC Adaptor
- NB Adaptor
- TV/Monitor Standby Power
- PC Peripherals

## Simplified Application Circuit









## Looking for pricing, stock, or lifecycle information?

Click below to explore more details on WIN SOURCE:

-  [View RT7738GGE on WIN SOURCE](#)
-  [Richtek USA Inc. Information](#)

## Optimize Your Supply Chain with WIN SOURCE Solutions

-  Global Sourcing Solution
-  Obsolete Management
-  Cost Control Management
-  Shortage Management
-  Alternative Solution
-  Excess Inventory Management