

2A/1A Variable Output LDO Regulators

BA00DD0XX series BA00CC0XX series

•General Description

The BA00DD0XX and BA00CC0XX series are low-saturation regulators available for outputs up to 2A/1A. The output voltage can be arbitrarily configured using the external resistance. These series of LDO regulators are offered in a broad packaging lineup.

This IC has a built-in over-current protection circuit that prevents the destruction of the IC due to output short circuits and a thermal shutdown circuit that protects the IC from thermal damage due to overloading.

•Features

- ±1% high-precision output voltage (BA00DD0XX)
- Low saturation with PNP output
- Built-in over-current protection circuit that prevents the destruction of the IC due to output short circuits
- Built-in thermal shutdown circuit for protecting the IC from thermal damage due to overloading
- Built-in over-voltage protection circuit that prevents the destruction of the IC due to power supply surges

•Key Specifications

- Input Power Supply Voltage: 25V(Max.)
- Output voltage type: Variable
- Output current: BA00DD0XX series 2A(Max.)
BA00CC0XX series 1A(Max.)
- Shutdown current: 0µA(Typ.)
- Operating temperature range: -40°C to +125°C

•Applications

Usable in DSP power supplies for DVDs and CDs, FPDs, televisions, personal computers or any other consumer device

•Packages

	W (Typ.) x D (Typ.) x H (Max.)
HRP5	9.395mm x 10.54 mm x 2.005mm
TO252-5	6.50 mm x 9.50 mm x 2.50 mm
TO220CP-V5	10.00 mm x 20.12 mm x 4.60 mm
TO220FP-5	10.00 mm x 30.50 mm x 4.60 mm
TO220FP-5(V5)	10.00 mm x 31.50 mm(Max) x 4.60 mm(mold size)

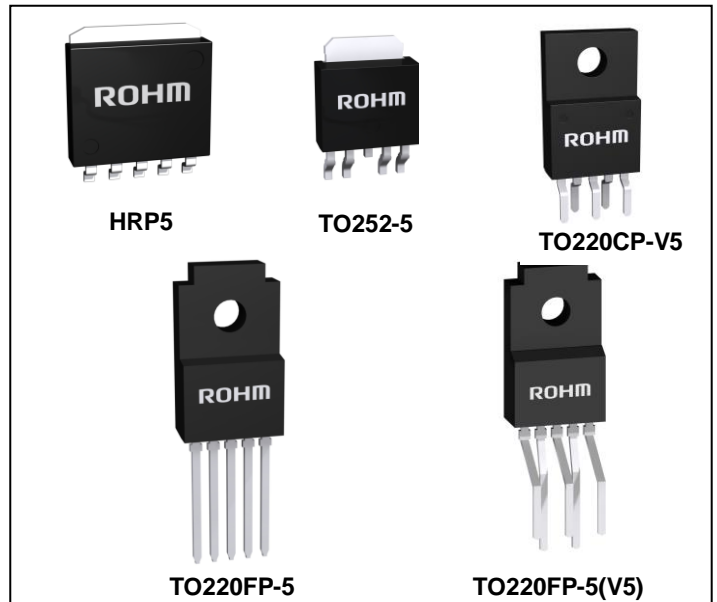

•Ordering Information

B A 0 0 x x 0 W x x x - x x

Part Number	Output voltage 00:Variable	Output Current CC0 : 1A DD0 : 2A	Shutdown switch W : Includes switch	Package HFP : HRP5 FP : TO252-5 CP : TO220CP-V5 T : TO220FP-5 :TO220FP-5(V5)	Packaging and forming specification TR: Embossed tape and reel (HRP5) E2: Embossed tape and reel (TO252-5,TO220CP-V5) None : Container Tube (TO220FP-5,TO220FP-5(V5)) V5 :Forming(V5 only)
-------------	-------------------------------	--	--	---	--

•Lineup

Maximum output current (Max.)	Package		Orderable Part Number
1A	TO220FP-5	Tube of 500	BA00CC0WT
	TO220CP-V5	Reel of 500	BA00CC0WCP-V5E2
	TO252-5	Reel of 2000	BA00CC0WFP-E2
	TO220FP-5(V5)	Tube of 500	BA00CC0WT-V5
2A	TO220CP-V5	Reel of 500	BA00DD0WCP-V5E2
	HRP5	Reel of 2000	BA00DD0WHFP-TR

○Product structure : Silicon monolithic integrated circuit ○This product is not designed protection against radioactive rays.

●Block Diagrams / Pin Configurations / Pin Descriptions

[BA00CC0WFP] [BA00DD0WHFP]

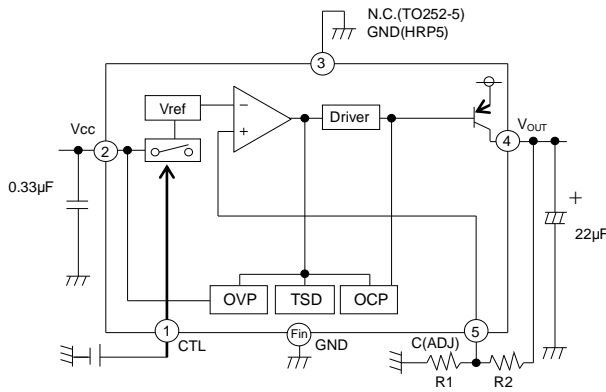

TOP VIEW

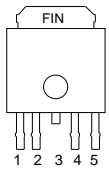

TO252-5

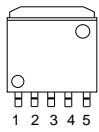

HRP5

PINNo.	Symbol	Function
1	CTL	Output voltage ON / OFF control
2	V _{CC}	Power supply voltage input
3	N.C./GND	Unconnected terminal/GND*
4	OUT	Voltage output
5	C	Output voltage regulation terminal
FIN	GND	GND

*TO252-5 is N.C., and HRP5 is GND

[BA00CC0WT] [BA00CC0WCP-V5] [BA00CC0WT-V5] [BA00DD0WCP-V5]

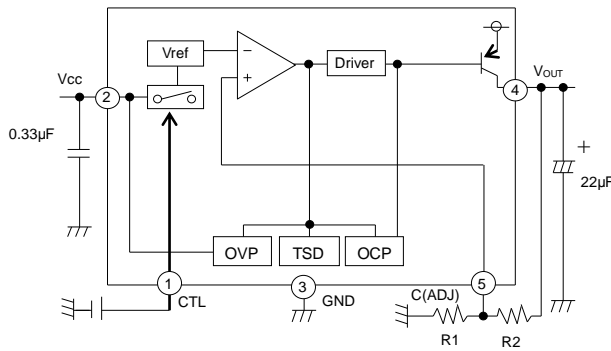

TOP VIEW

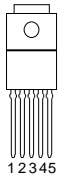

TO220FP-5

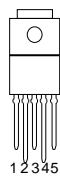

TO220FP-5(V5)

PINNo.	Symbol	Function
1	CTL	Output voltage ON/OFF control
2	V _{CC}	Power supply voltage input
3	GND	GND
4	OUT	Voltage output
5	ADJ	Output voltage regulation terminal

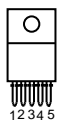

TO220CP-V5

●Absolute Maximum Ratings (Ta=25°C)

Parameter	Symbol	Limits	Unit
Input Power Supply Voltage ^{*1}	Vcc	-0.3 to +35	V
Power Dissipation ^{*2}	Pd	2300(HRP5)	mW
		1300(TO252-5)	
		2000(TO220FP-5)	
		2000(TO220FP-5(V5))	
		2000(TO220CP-V5)	
Operating Temperature Range	Topr	-40 to +125	°C
Ambient Storage Temperature	Tstg	-55 to +150	°C
Junction Temperature	Tjmax	+150	°C
Output Control Terminal Voltage	VCTL	-0.3 to +Vcc	V
Voltage Applied to the Tip ^{*3}	Vcc peak	+50	V

*1 Must not exceed Pd

*2 HRP5 : In cases in which Ta≥25°C when a 70mm x 70mm x 1.6mm glass epoxy board is used, the power is reduced by 18.4 mW/°C.
 TO252-5 : In cases in which Ta≥25°C when a 70mm x 70mm x 1.6mm glass epoxy board is used, the power is reduced by 10.4 mW/°C.
 TO252FP-5 : No heat sink. When Ta≥25°C, the power is reduced by 16 mW/°C.

*3 Applied voltage: 200msec or less (tr≥1msec)

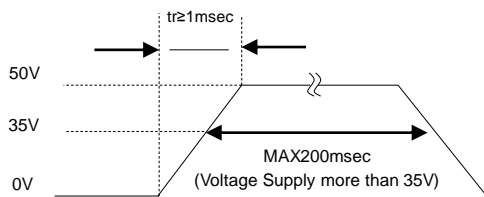

●Recommended Operating Ratings (Ta=25°C)

Parameter	Symbol	Min.	Max.	Unit
Input Power Supply Voltage	BA00CC0XX	4.0	25.0	V
	BA00DD0XX	3.0	25.0	
Output Current	BA00CC0XX	-	1	A
	BA00DD0XX	-	2	
Output Control Terminal Voltage	VCTL	0	Vcc	V

●Electrical Characteristics

BA00CC0XX Series (Unless otherwise specified, Ta=25°C, Vcc=10V, V_{CTL}=5V, I_o=500mA, V_o=5V Setting)

Parameter	Symbol	Limit			Unit	Conditions
		Min.	Typ.	Max.		
Shut Down Current	I _{sd}	-	0	10	μA	V _{CTL} =0V
Bias Current	I _b	-	2.5	5.0	mA	V _{CTL} =2V, I _o =0mA
C Terminal Voltage	V _c	1.200	1.225	1.250	V	I _o =50mA
Dropout Voltage	ΔV _d	-	0.3	0.5	V	V _{cc} =V _o x 0.95
Peak Output Current	I _o	1.0	-	-	A	
Ripple Rejection	R.R.	45	55	-	dB	f=120Hz, e _{in} *4=1Vrms, I _o =100mA
Line Regulation	Reg.I	-	20	100	mV	V _{cc} =6→25V
Load Regulation	Reg.L	-	50	150	mV	I _o =5mA→1A
Temperature Coefficient of Output Voltage *5	T _{cvo}	-	±0.02	-	%/°C	I _o =5mA, T _j =0°C to 125°C
Output Short Current	I _{os}	-	0.40	-	A	V _{cc} =25V
ON Mode Voltage	V _{thH}	2.0	-	-	V	ACTIVE MODE, I _o =0mA
OFF Mode Voltage	V _{thL}	-	-	0.8	V	OFF MODE, I _o =0mA
Input High Current	I _{CTL}	100	200	300	μA	V _{CTL} =5V, I _o =0mA

*4 e_{in} : Input Voltage Ripple

*5 Not 100% tested

BA00DD0XX Series (Unless otherwise specified, Ta=25°C, Vcc=8V, V_{CTL}=3V, V_o=5.0V setting)

Parameter	Symbol	Limit			Unit	Conditions
		Min.	Typ.	Max.		
Shut Down Current	I _{sd}	-	0	10	μA	V _{CTL} =0V, I _o =0mA
Bias Current	I _b	-	0.9	2.0	mA	I _o =0mA
ADJ pin Voltage	V _{adj}	1.257	1.270	1.283	V	I _o =100mA
ADJ pin Current *6	I _{adj}	-	50	-	nA	I _o =0mA
Dropout Voltage1	ΔV _{d1}	-	0.3	0.5	V	V _{cc} =0.95 x V _o , I _o =1A
Dropout Voltage2	ΔV _{d2}	-	0.45	0.7	V	V _{cc} =0.95 x V _o , I _o =2A
Peak Output Current	I _o	2.0	-	-	A	
Ripple Rejection	R.R.	-	55	-	dB	f=120Hz, e _{in} *7=-20dBV, I _o =100mA
Line Regulation	Reg.I	-	15	35	mV	V _{cc} =5.7V→25V, I _o =200mA
Load Regulation	Reg.L	-	50	100	mV	I _o =0mA→2A
Temperature Coefficient of Output Voltage *6	T _{cvo}	-	±0.02	-	%/°C	I _o =5mA, T _j =0°C to 125°C
Output Short Current	I _{os}	-	0.4	-	A	V _{cc} =25V
CTL ON Mode Voltage	V _{on}	2.0	-	V _{cc}	V	ACTIVE MODE, I _o =0mA
CTL OFF Mode Voltage	V _{off}	-	-	0.8	V	OFF MODE, I _o =0mA
CTL Input Current	I _{CTL}	-	60	120	μA	V _{CTL} =3V, I _o =0mA

*6 Not 100% tested

*7 e_{in}=Input Voltage Ripple

•Typical Performance Curves

BA00CC0XX (3.3V preset voltage)

(Unless specified otherwise, Vcc=10V, VOUT=3.3V preset, VCTL=3V, Io=0mA, R1=2.0kΩ, and R2=3.4kΩ)

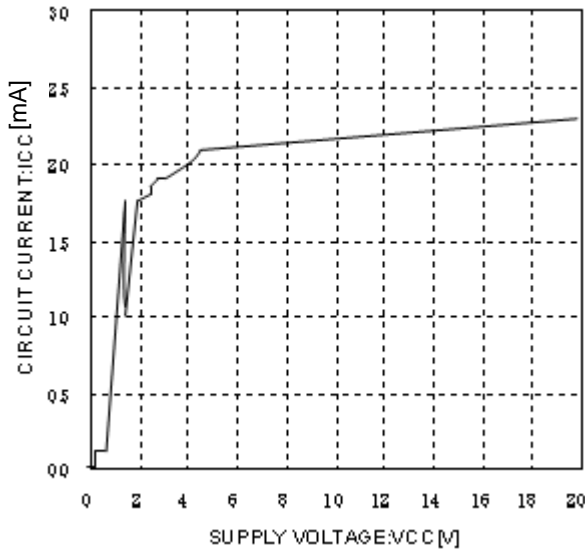

Fig.1
Circuit Current

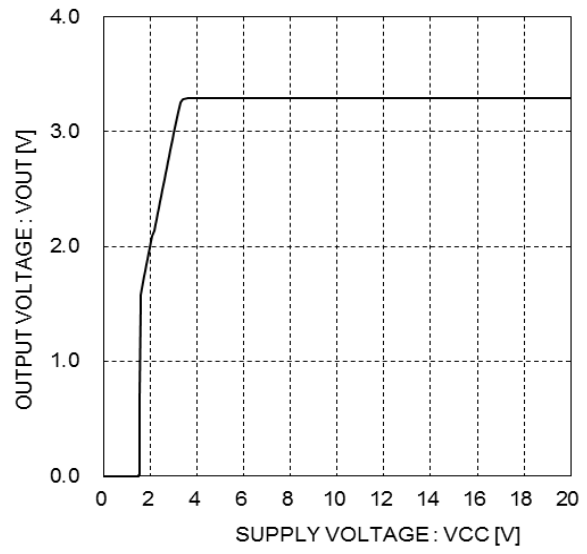

Fig.2
Input Stability
(Io=0mA)

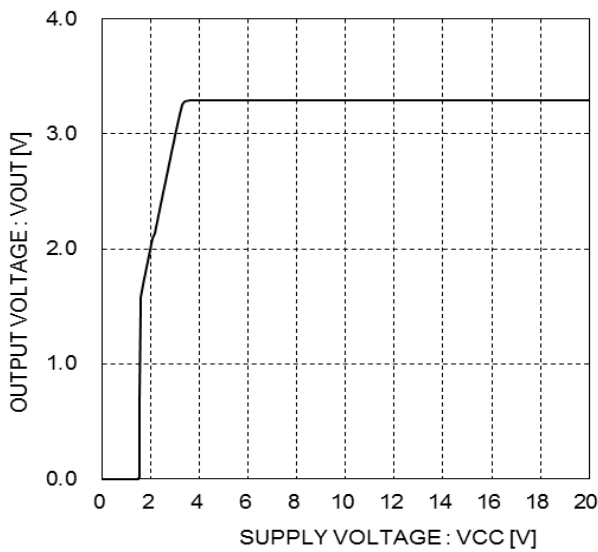

Fig.3
Input Stability
(Io=500mA)

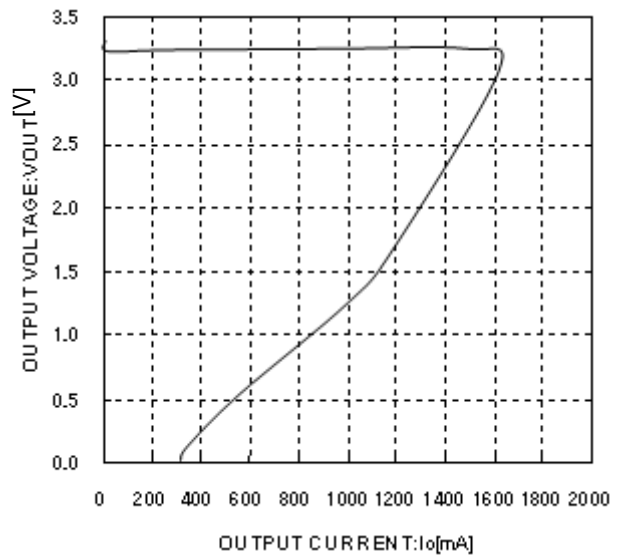

Fig.4
Load Stability

•Typical Performance Curves - continued

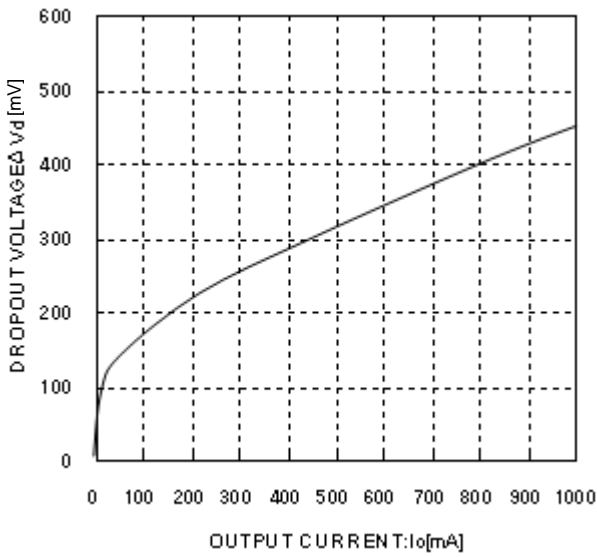

Fig.5
Input/Output Voltage Difference
I_o-ΔV_d Characteristics (V_{cc}=2.95V)

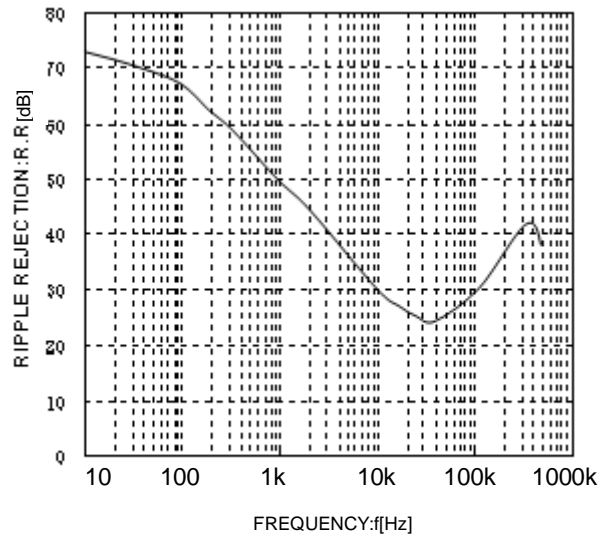

Fig.6
Ripple Rejection Characteristics
(I_o=100mA)

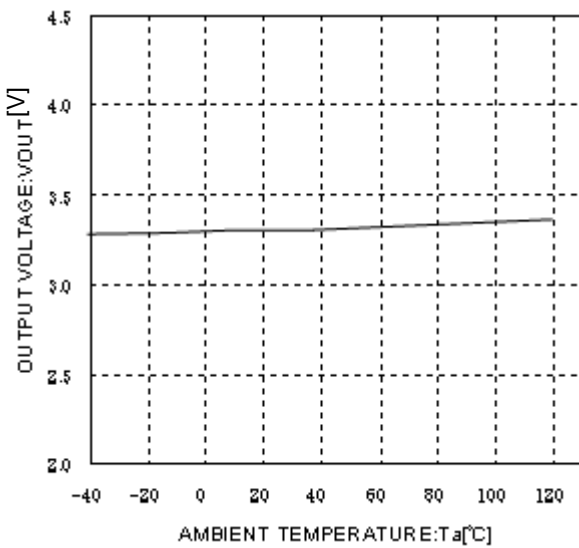

Fig.7
Output Voltage
Temperature Characteristics

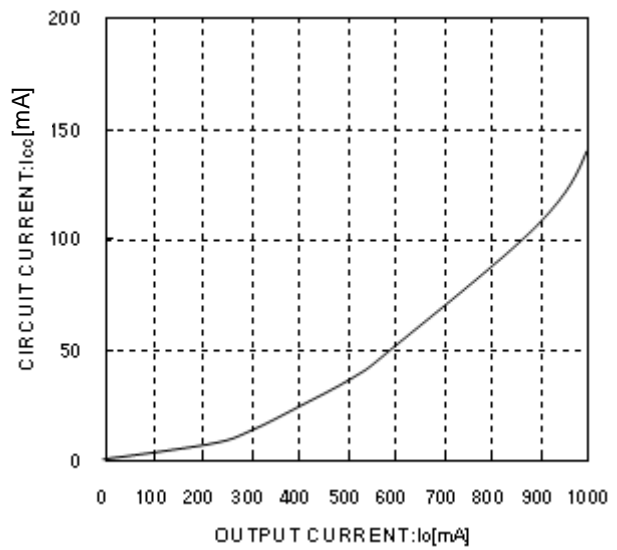

Fig.8
Circuit Current by load Level
(I_o=0mA→1A)

•Typical Performance Curves - continued

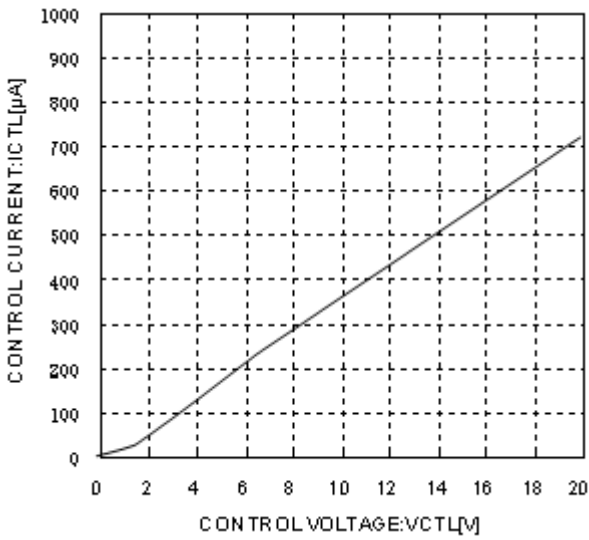

Fig.9
CTL Voltage vs. CTL Current

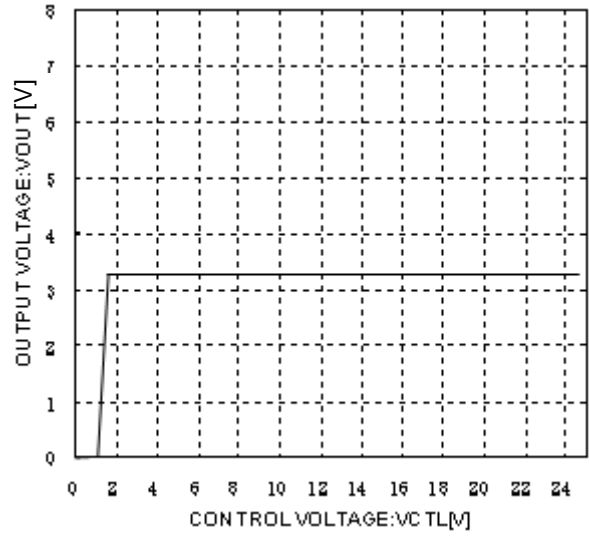

Fig.10
CTL Voltage vs. Output Voltage

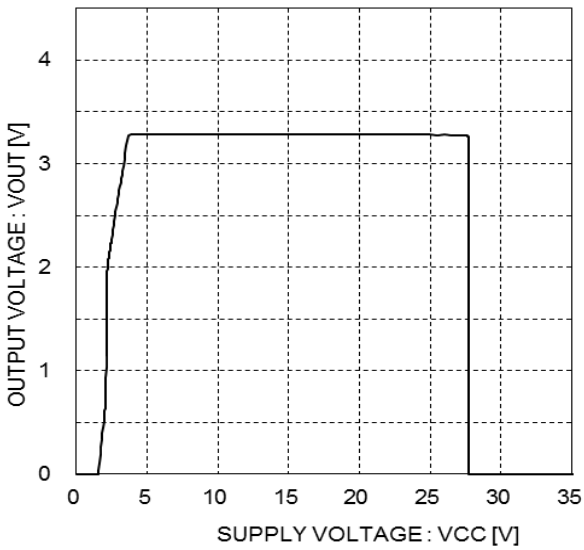

Fig.11
Oversvoltage Operating
Characteristics (Io=200mA)

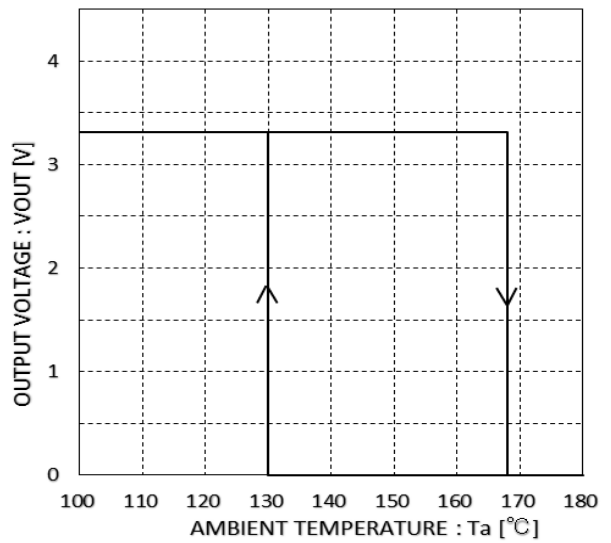

Fig.12
Thermal Shutdown
Circuit Characteristics

•Typical Performance Curves - continued

BA00DD0XX(5.0V preset voltage)

(Unless specified otherwise, $V_{CC}=8V$, $V_{OUT}=5V$ preset, $V_{CTL}=3V$, $I_o=0mA$, $R_1=15k\Omega$, and $R_2=44k\Omega$)

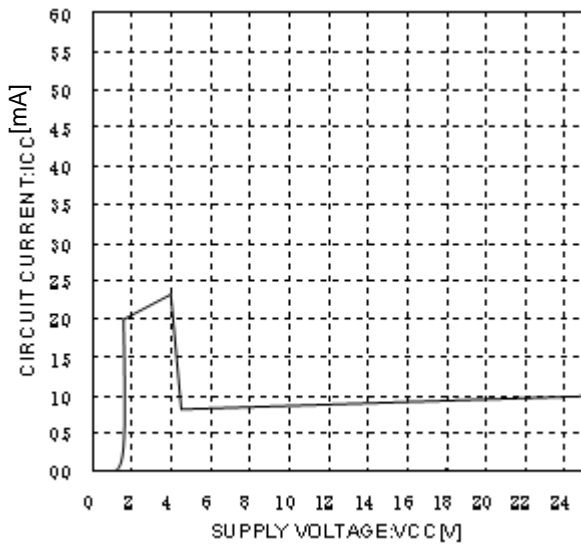

Fig.13
Circuit Current

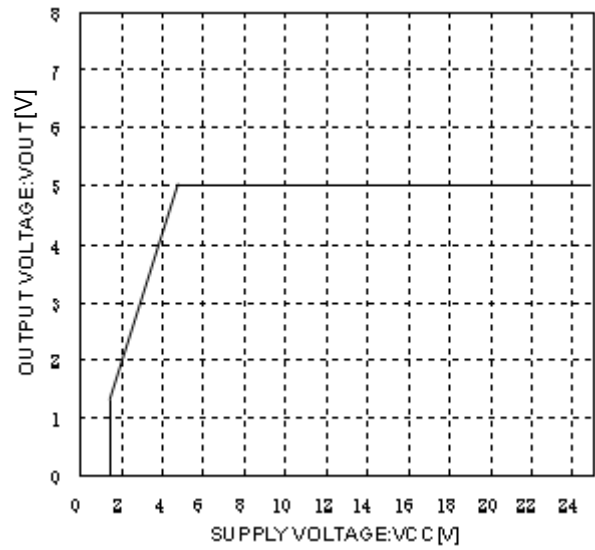

Fig.14
Input Stability

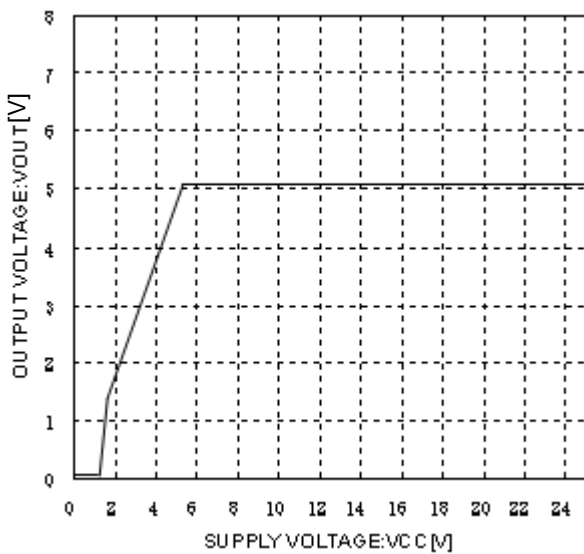

Fig.15
Input Stability
($I_o=2A$)

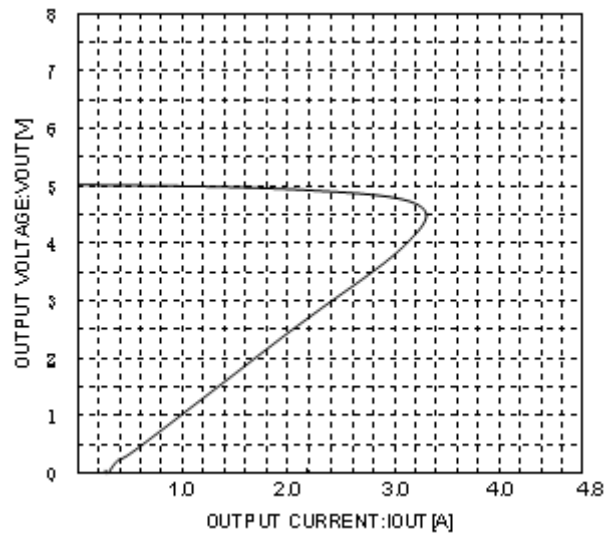

Fig.16
Load Stability

•Typical Performance Curves - continued

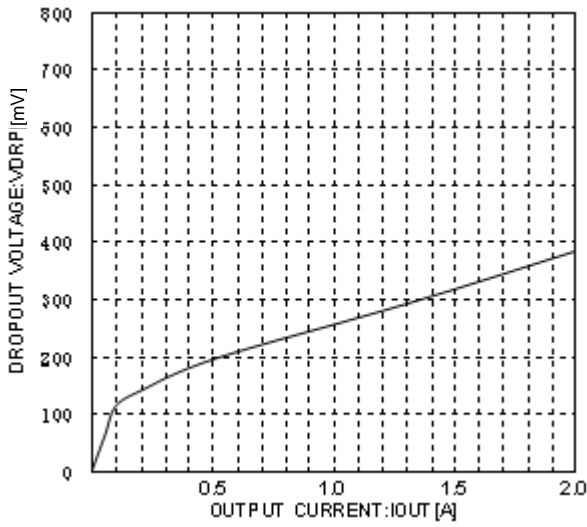

Fig.17
Input/Output Voltage Difference
I_o-ΔV_d Characteristics (V_{cc}=4.75V)

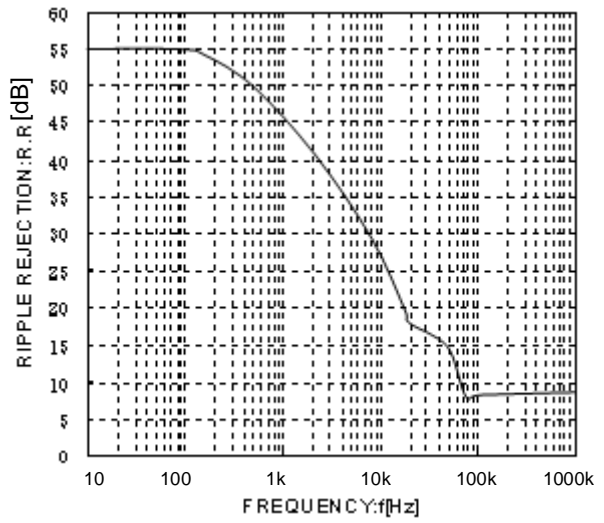

Fig.18
Ripple Rejection Characteristics
(I_o=100mA)

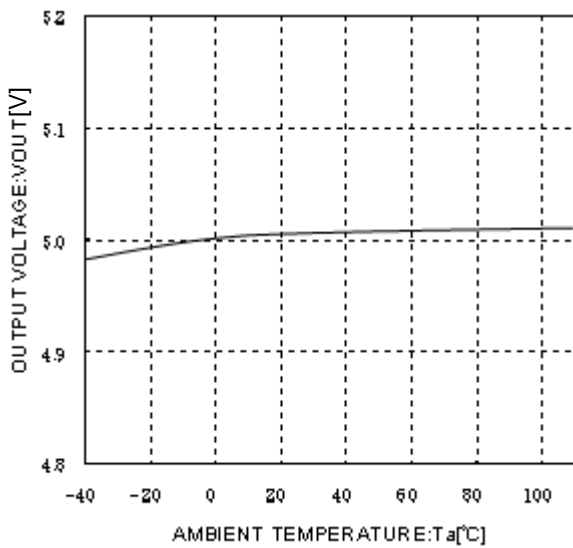

Fig.19
Output Voltage
Temperature Characteristics

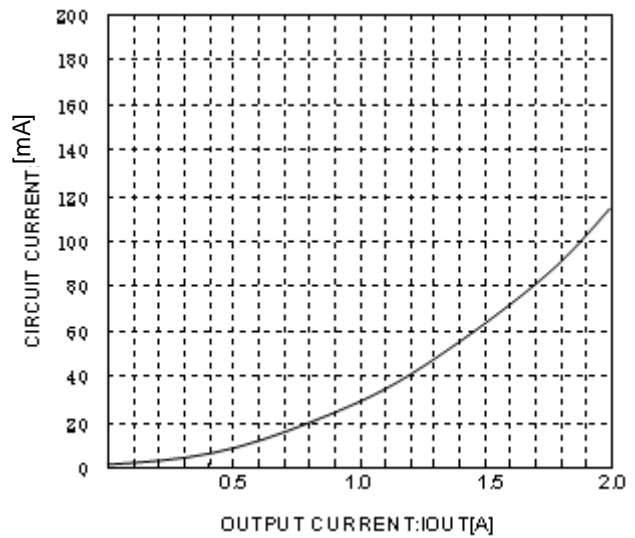

Fig.20
Circuit Current by load Level
(I_o=0mA→2A)

•Typical Performance Curves - continued

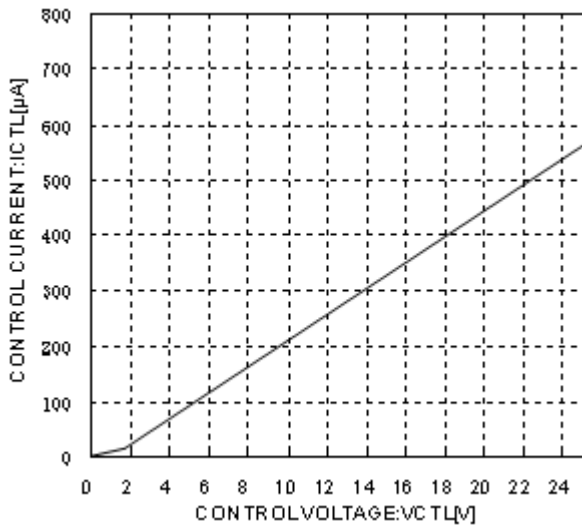

Fig.21
CTL Voltage vs. CTL Current

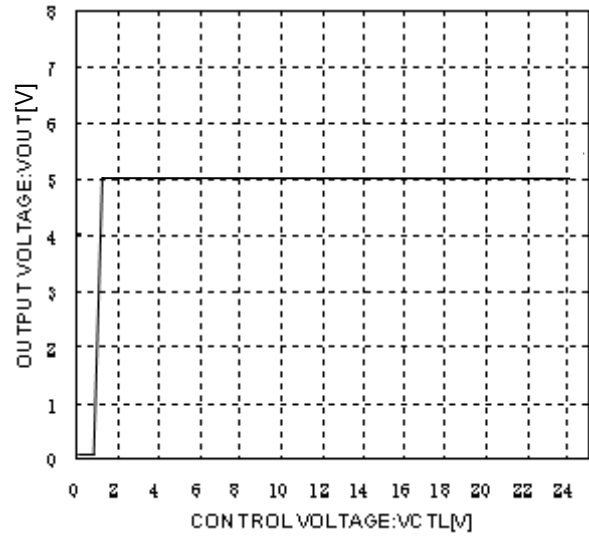

Fig.22
CTL Voltage vs. Output Voltage

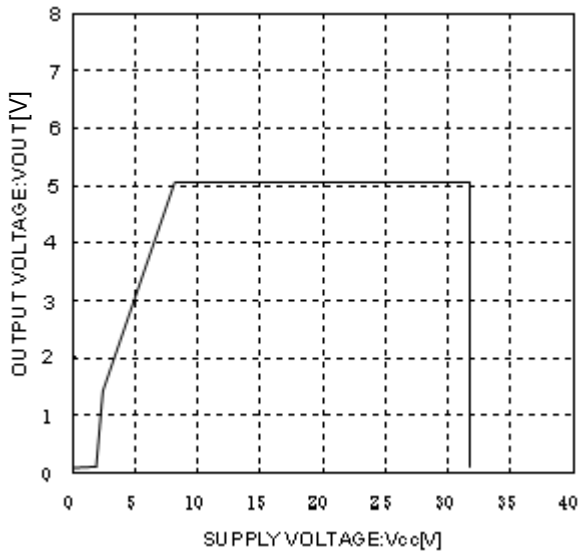

Fig.23
Overvoltage Operating
Characteristics (I_o=200mA)

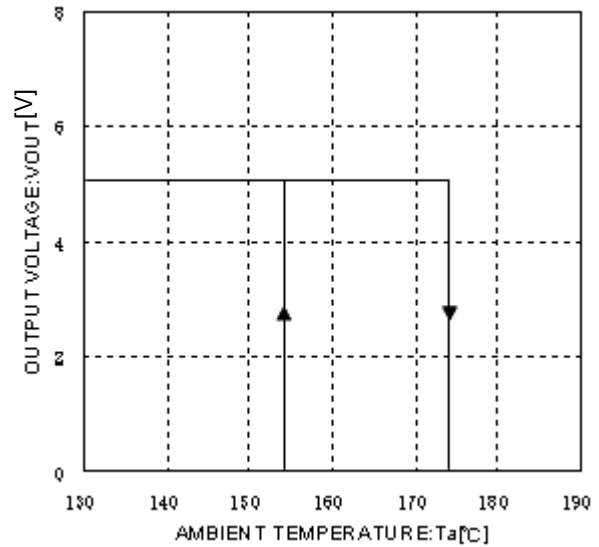

Fig.24
Thermal Shutdown
Circuit Characteristics

●I/O equivalence circuit

< BA00CC0WT/BA00CC0WFP/BA00CC0WT-V5/BA00CC0WCP-V5 >

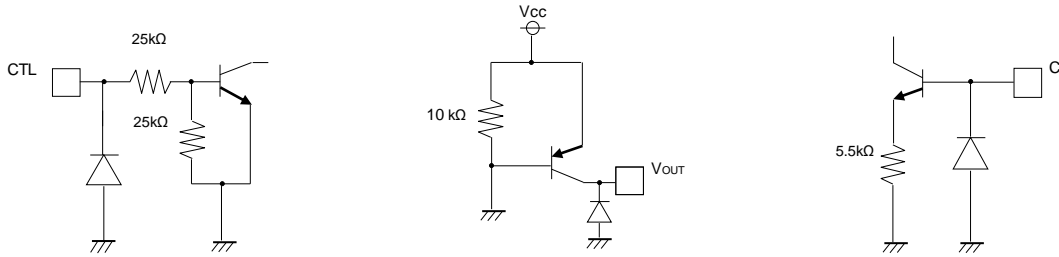

Fig.25

< BA00DD0WCP-V5/BA00DD0WHFP >

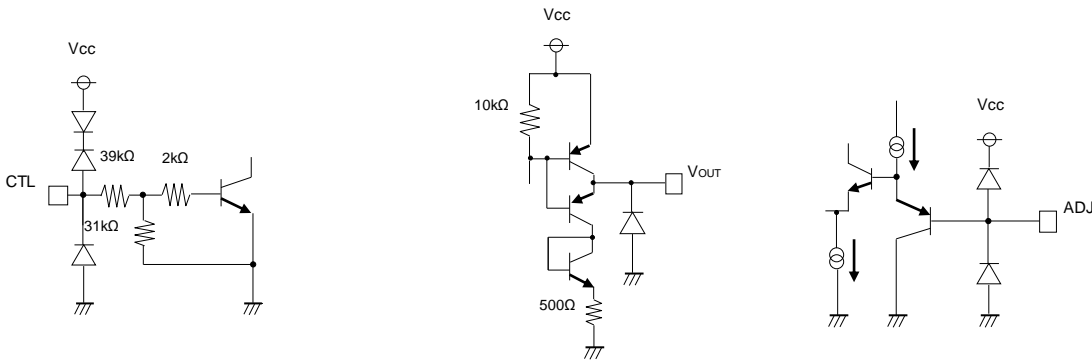

Fig.26

●Output Voltage Configuration Method

Please connect resistors R1 and R2 (which determines the output voltage) as shown in Fig.27.

Please be aware that the offset due to the current that flows from the ADJ terminal becomes large when resistors with large values are used. The use of resistors with R1=2kΩ to 15 kΩ is recommended.

$$V_o = V_c (V_{ADJ}) \times \left(1 + \frac{R_2}{R_1} \right)$$

BA00CC0XX V_c : 1.225 (Typ.)
 BA00DD0XX V_{ADJ} : 1.270 (Typ.)

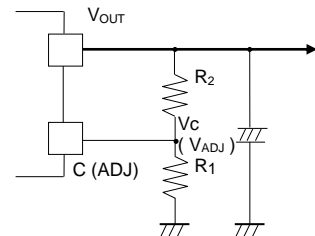

Fig.27

•Power Dissipation

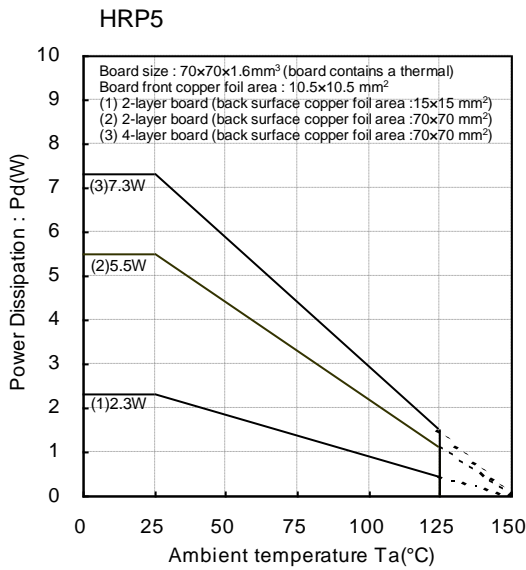

Fig.28

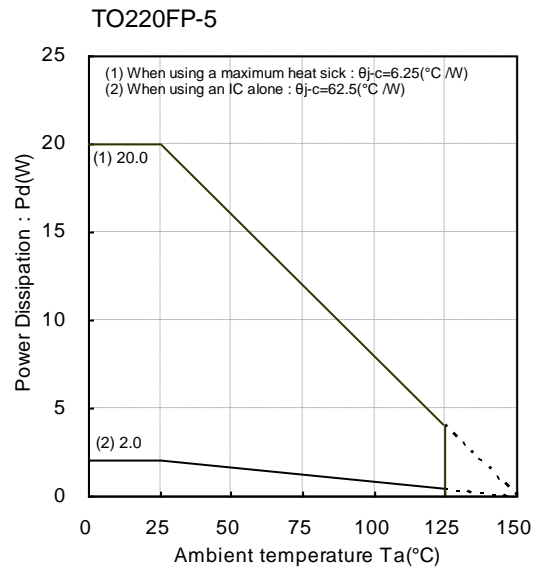

Fig.29

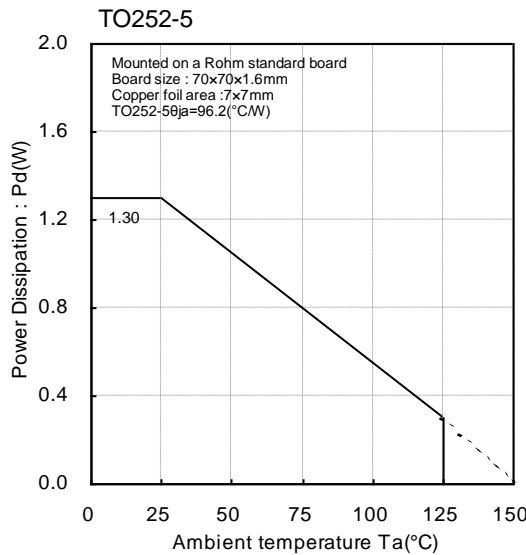

Fig.30

When using at temperatures over Ta=25°C, please refer to the heat reducing characteristics shown in Fig.28 through 30. The IC characteristics are closely related to the temperature at which the IC is used, so it is necessary to operate the IC at temperatures less than the maximum junction temperature TjMAX.

Fig.29 shows the acceptable loss and heat reducing characteristics of the TO220FP package. The portion shown by the diagonal line is the acceptable loss range that can be used with the IC alone. Even when the ambient temperature Ta is a normal temperature (25°C), the chip (junction) temperature Tj may be quite high so please operate the IC at temperatures less than the acceptable loss Pd.

The calculation method for power consumption Pc(W) is as follows:

Vcc : Input voltage
 Vo : Output voltage
 Io : Load current
 Icca : Circuit current

$$Pc = (Vcc - Vo) \times Io + Vcc \times Icca$$

Acceptable loss Pd ≤ Pc

Solving this for load current Io in order to operate within the acceptable loss,

$$Io \leq \frac{Pd - Vcc \times Icca}{Vcc - Vo}$$

(Please refer to Fig.8 and 20 for Icca.)

It is then possible to find the maximum load current IOMAX with respect to the applied voltage Vcc at the time of thermal design.

Calculation Example

Example 1) When Ta=85°C, Vcc=8.3V, Vo=3.3V, BA33DD0WT

$$I_o \leq \frac{1.04 - 8.3 \times I_{cca}}{5}$$

$$I_o \leq 200\text{mA} \quad (I_{cca} : 2\text{mA})$$

$\left(\begin{array}{l} \text{With the IC alone : } \theta_{ja}=62.5^\circ\text{C/W} \rightarrow -16\text{mW}/^\circ\text{C} \\ 25^\circ\text{C} = 2000\text{mW} \rightarrow 85^\circ\text{C} = 1040\text{mW} \end{array} \right)$

Please refer to the above information and keep thermal designs within the scope of acceptable loss for all operating temperature ranges. The power consumption Pc of the IC when there is a short circuit (short between Vo and GND) is:

$$P_c = V_{cc} \times (I_{cca} + I_{short})$$

short : Short circuit current

•Terminal Vicinity Settings and Cautions

○Vcc Terminal

Please attach a capacitor (greater than 0.33μF) between the Vcc and GND.

The capacitance values differ depending on the application, so please chose a capacitor with sufficient margin and verify the operation on an actual board.

○CTL Terminal

The CTL terminal is turned ON at 2.0V and higher and OFF at 0.8V and lower within the operating power supply voltage range.

BA00CC0XX series, The power supply and the CTL terminal in any order without problems.

•Vo Terminal

Please attach an anti-oscillation capacitor between VOUT and GND. The capacitance of the capacitor may significantly change due to factors such as temperature changes, which may cause oscillations. Please use a tantalum capacitor or aluminum electrolytic capacitor with favorable characteristics and small external series resistance (ESR) even at low temperatures. The output oscillates regardless of whether the ESR is large or small. Please use the IC within the stable operating region while referring to the ESR characteristics reference data shown in Fig.31 through 33. In cases where there are sudden load fluctuations, the large capacitor is recommended.

Below figure, it is ESR-to-Io stable operating region characteristics, measured by 22μF-ceramic-capacitor and resistor connected in series.

This characteristic is not equal value perfectly to 22μF-aluminum electrolytic capacitor measurement method.

Note, however, that the stable operating region in the figure depends on the board's wiring impedance, input impedance, and load impedance. Therefore, ascertain the final status of these items for actual use.

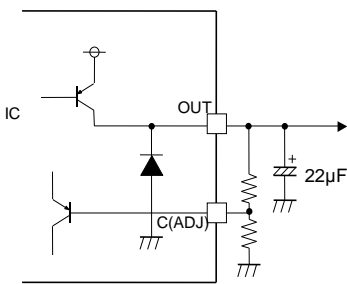

Fig.31: Output equivalent circuit

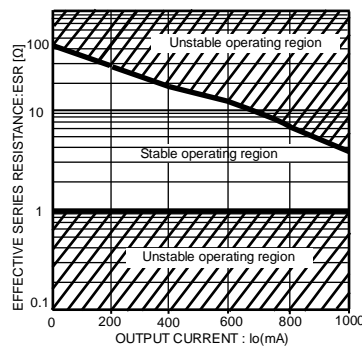

Fig.32: Io vs. ESR characteristics (BA00CC0XX, 22μF)

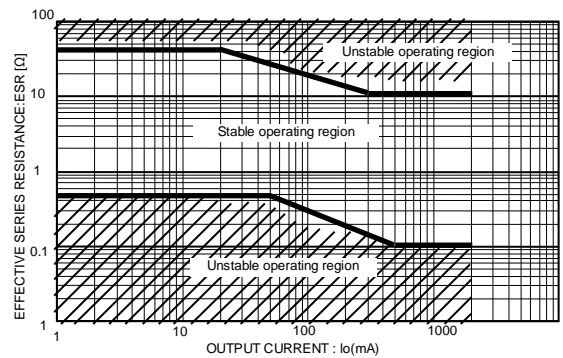

Fig.33: Io vs. ESR characteristics (BA00DD0XX, 22μF)

●Operational Notes

1) Protection Circuits

Overcurrent Protection Circuit

A built-in overcurrent protection circuit corresponding to the current capacity prevents the destruction of the IC when there are load shorts. This protection circuit is a “7”-shaped current control circuit that is designed such that the current is restricted and does not latch even when a large current momentarily flows through the system with a high-capacitance capacitor. However, while this protection circuit is effective for the prevention of destruction due to unexpected accidents, it is not suitable for continuous operation or transient use. Please be aware when creating thermal designs that the overcurrent protection circuit has negative current capacity characteristics with regard to temperature (Refer to Fig.4 and 16).

Thermal Shutdown Circuit (Thermal Protection)

This system has a built-in temperature protection circuit for the purpose of protecting the IC from thermal damage. As shown above, this must be used within the range of acceptable loss, but if the acceptable loss happens to be continuously exceeded, the chip temperature T_j increases, causing the temperature protection circuit to operate.

When the thermal shutdown circuit operates, the operation of the circuit is suspended. The circuit resumes operation immediately after the chip temperature T_j decreases, so the output repeats the ON and OFF states (Please refer to Fig.12 and 24 for the temperatures at which the temperature protection circuit operates).

There are cases in which the IC is destroyed due to thermal runaway when it is left in the overloaded state. Be sure to avoid leaving the IC in the overloaded state.

Reverse Current

In order to prevent the destruction of the IC when a reverse current flows through the IC, it is recommended that a diode be placed between the Vcc and Vo and a pathway be created so that the current can escape (Refer to Fig.34).

- 2) This IC is bipolar IC that has a P-board (substrate) and P+ isolation layer between each device, as shown in Fig.35. A P-N junction is formed between this P-layer and the N-layer of each device, and the P-N junction operates as a parasitic diode when the electric potential relationship is GND > Pin A, GND > Pin B, while it operates as a parasitic transistor when the electric potential relationship is Pin B > GND > Pin A. Parasitic devices are intrinsic to the IC. The operation of parasitic devices induces mutual interference between circuits, causing malfunctions and eventually the destruction of the IC itself. It is necessary to be careful not to use the IC in ways that would cause parasitic elements to operate. For example, applying a voltage that is lower than the GND (P-board) to the input terminal.

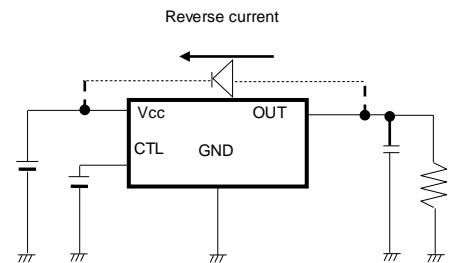

Fig.34: Bypass diode

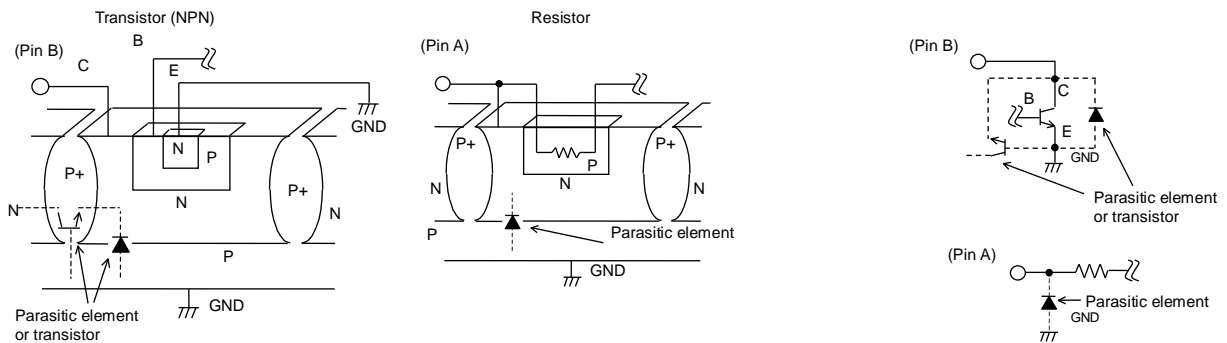

Fig.35: Example of the basic structure of a bipolar IC

Status of this document

The Japanese version of this document is formal specification. A customer may use this translation version only for a reference to help reading the formal version.

If there are any differences in translation version of this document formal version takes priority.

●Physical Dimension Tape and Reel Information

Package Name	HRP5
--------------	------

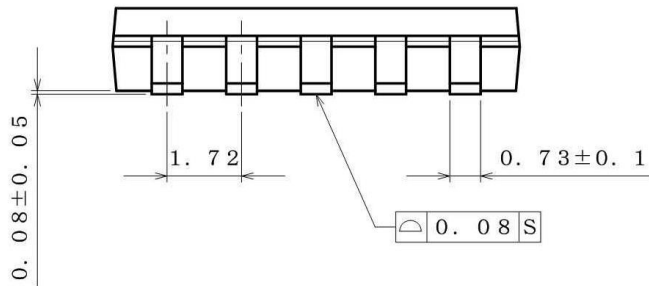
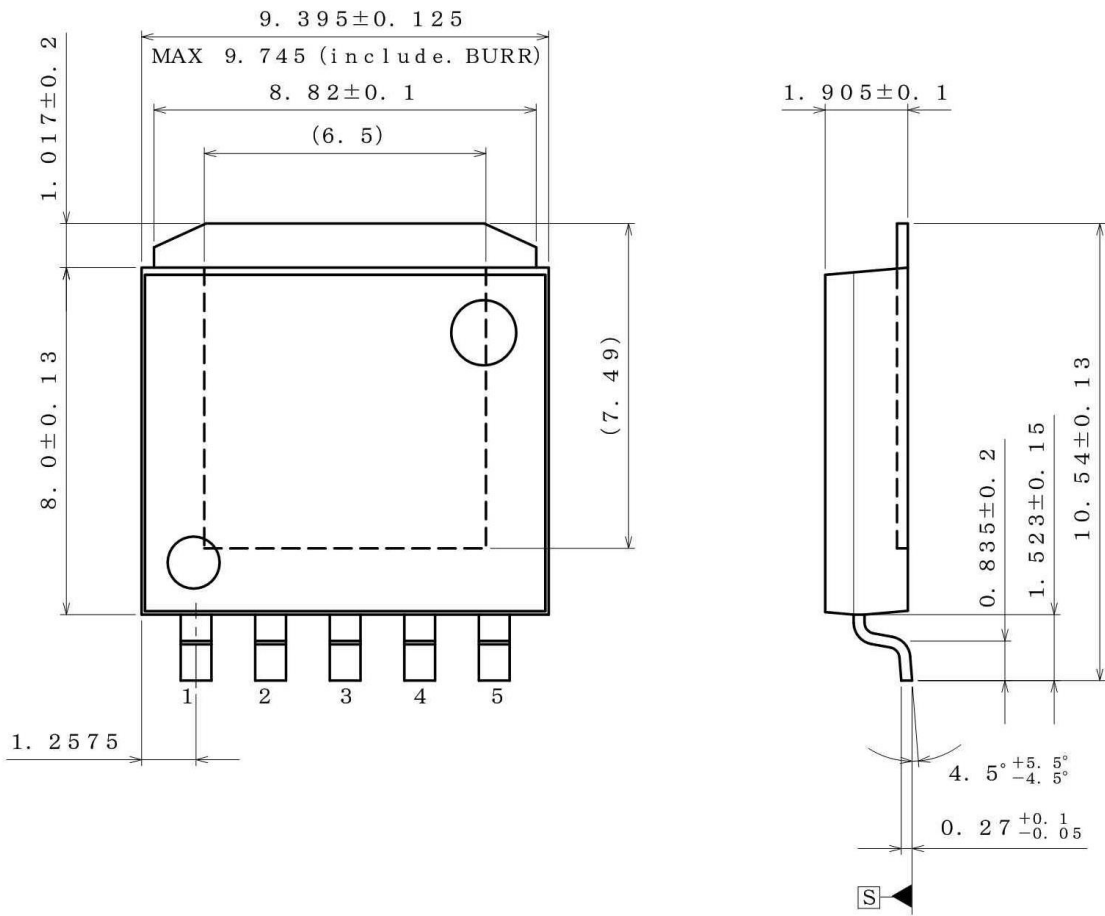

(UNIT ; mm)
 PKG : HRP5
 Drawing No. EX541-5002-2

< Tape and Reel Information >

Tape	Embossed carrier tape
Quantity	2000pcs
Direction of feed	TR The direction is the pin 1 of product is at the upper right when you hold reel on the left hand and you pull out the tape on the right hand

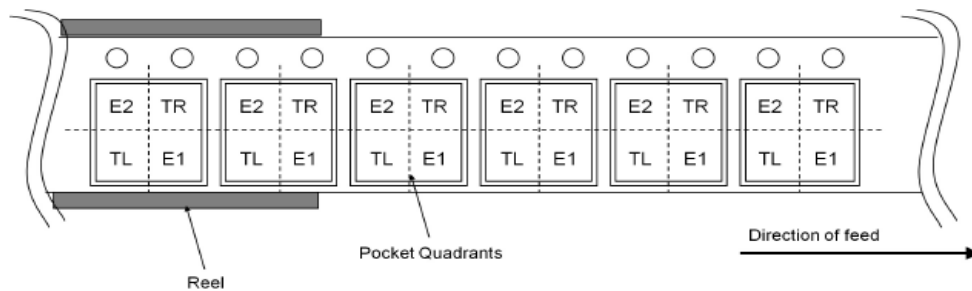

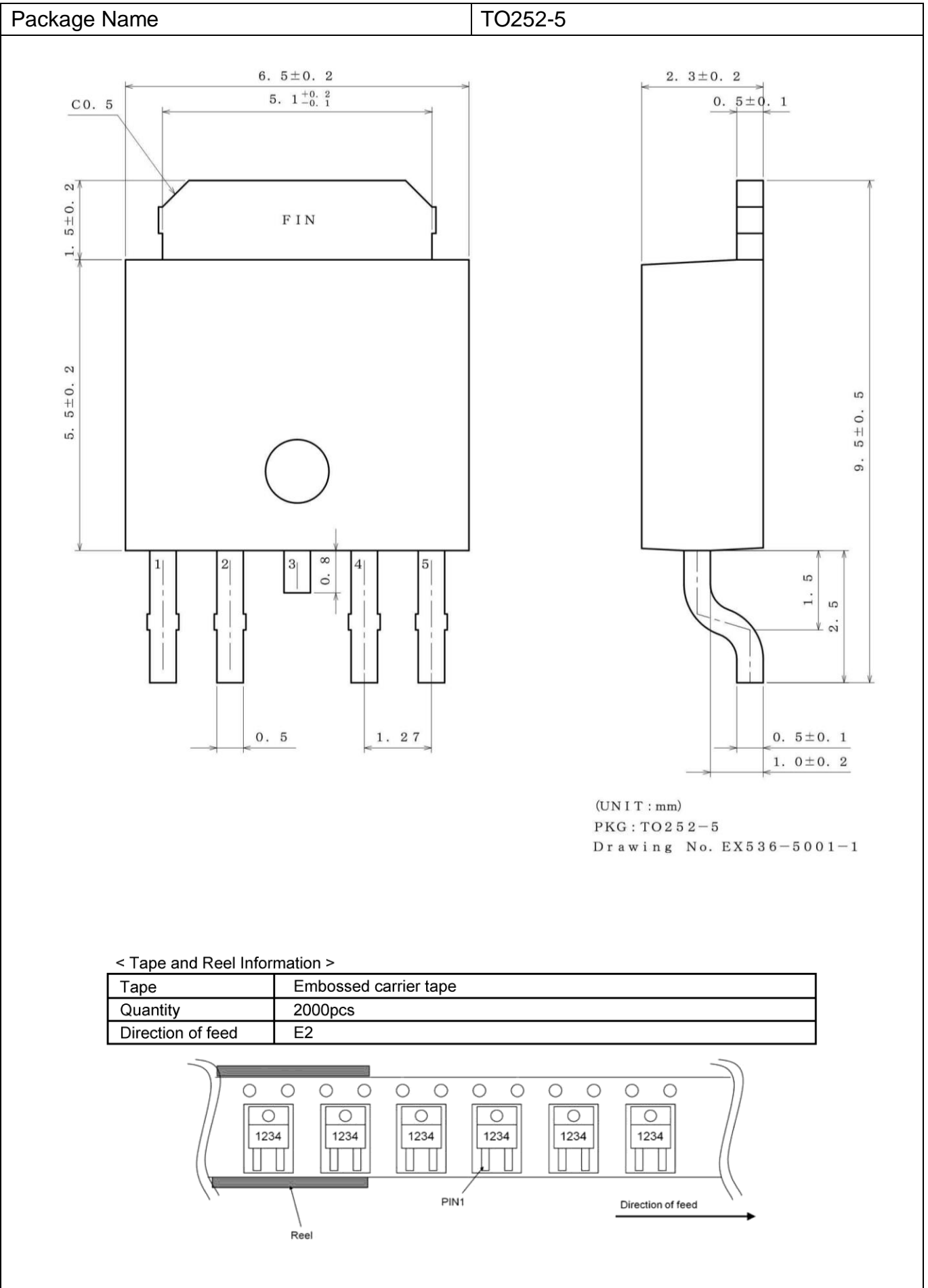

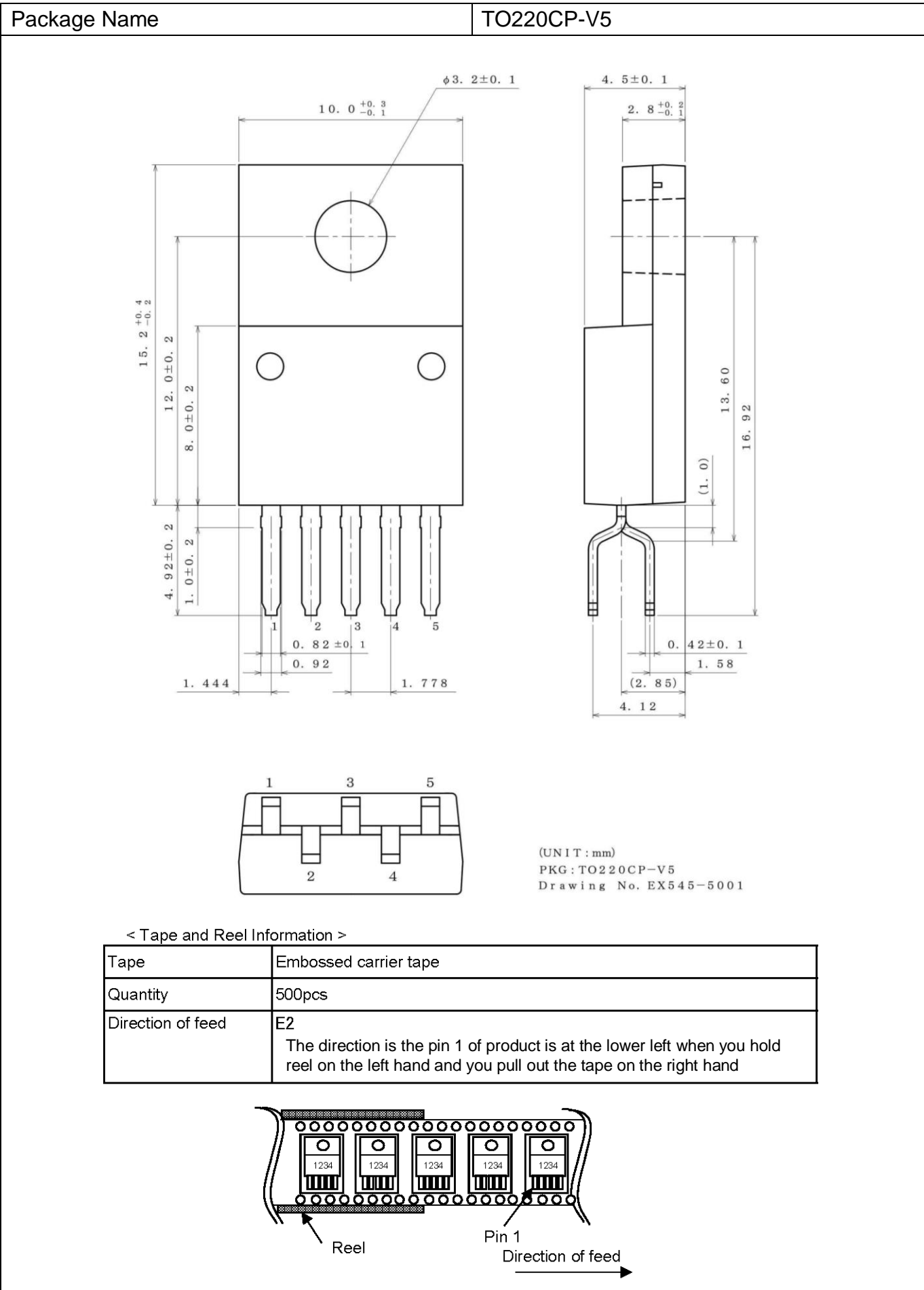

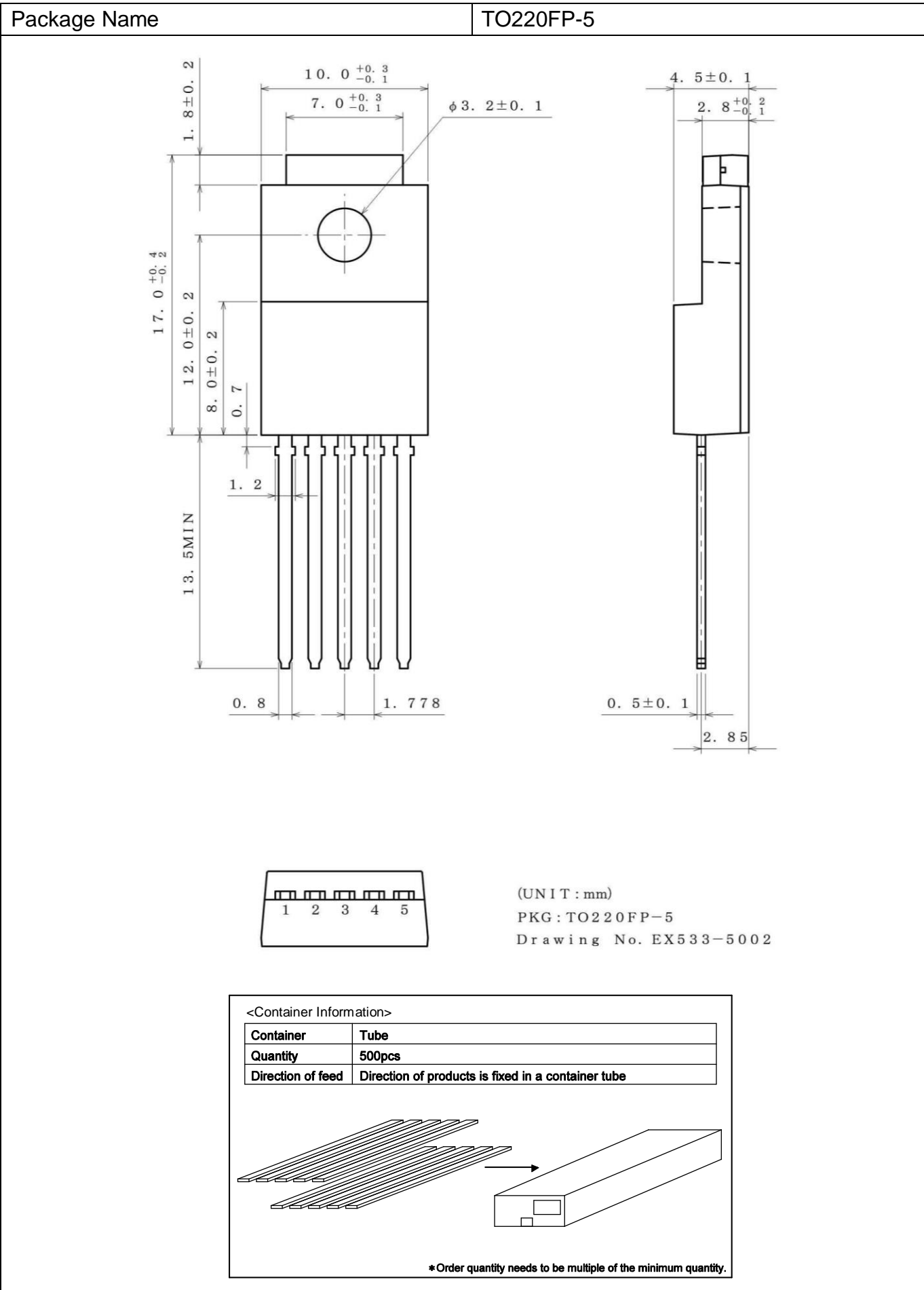

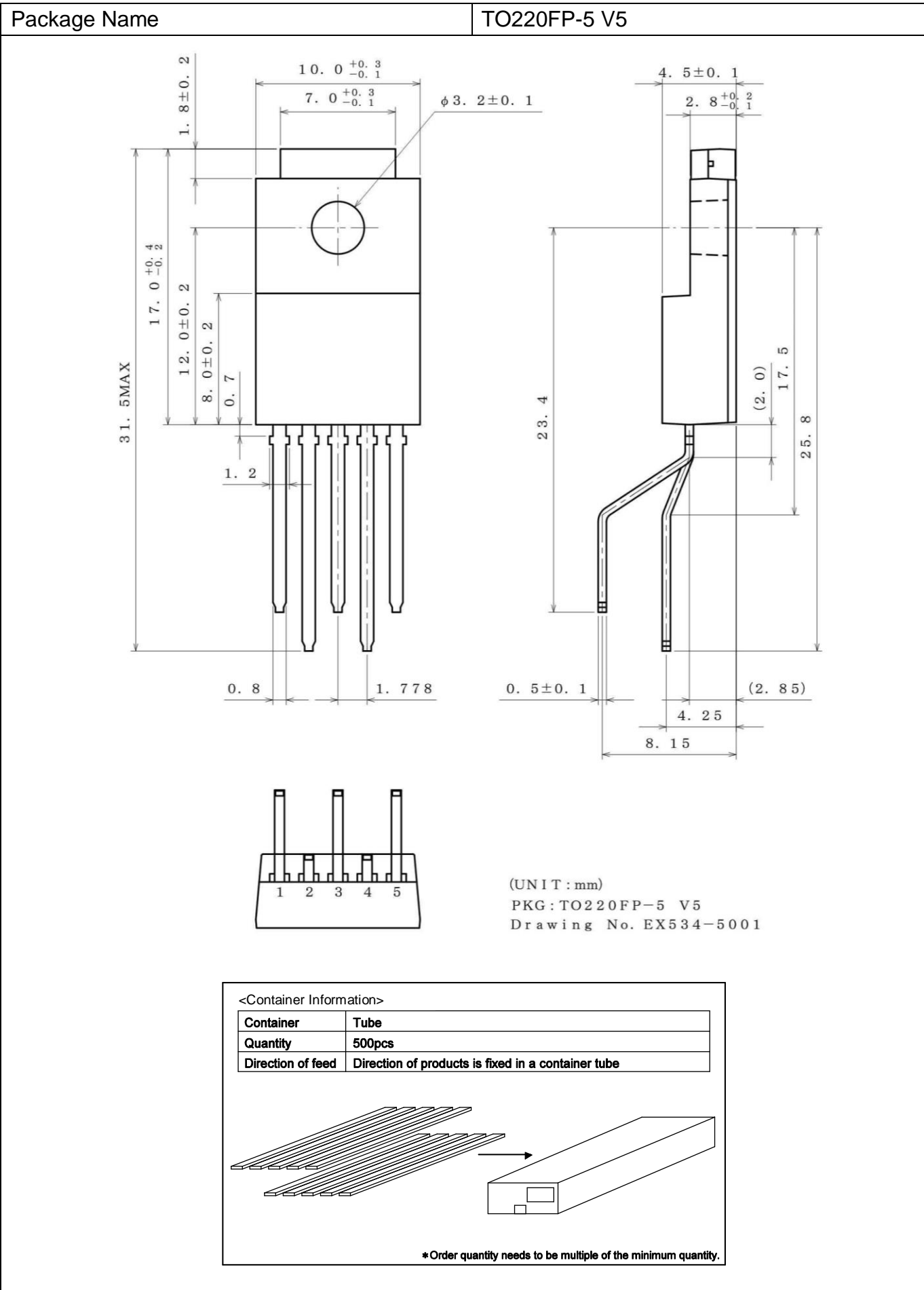

●Marking Diagrams

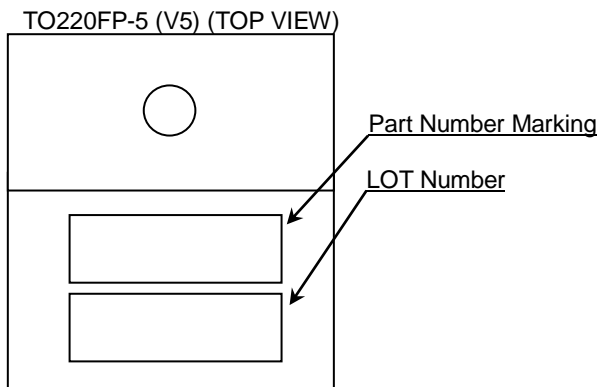
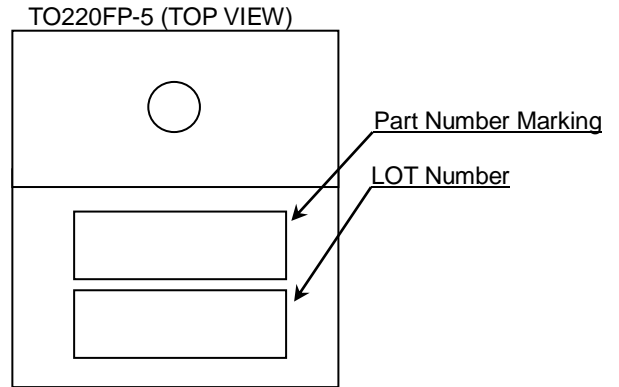
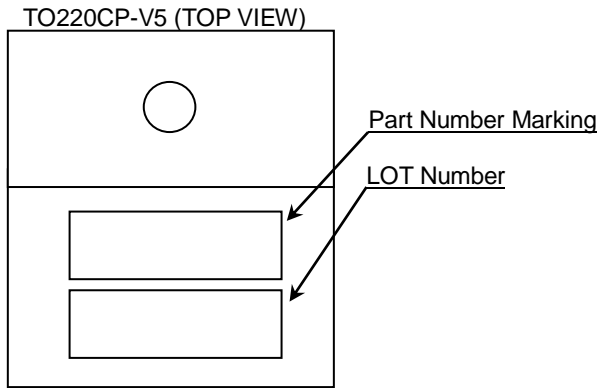
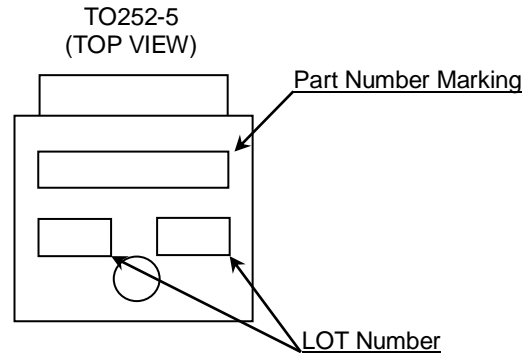
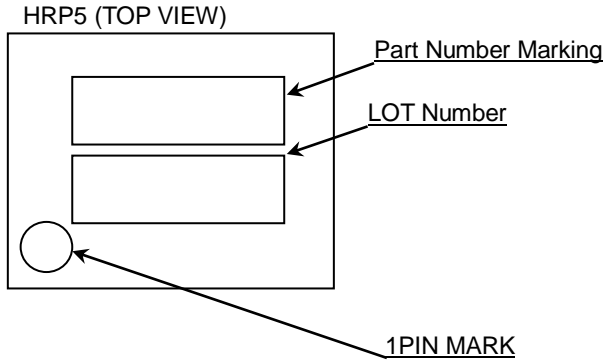

Orderable Part Number	Package	Part Number Marking
BA00CC0WT	TO220FP-5	00CC0W
BA00CC0WCP-V5E2	TO220CP-V5	00CC0W
BA00CC0WFP-E2	TO252-5	00CC0W
BA00CC0WT-V5	TO220FP-5(V5)	00CC0W
BA00DD0WCP-V5E2	TO220CP-V5	00DD0W
BA00DD0WHFP-TR	HRP5	00DD0W

●Revision History

Date	Revision	Changes
26.Jun.2012	001	New Release
25.July.2013	002	Page-13 Changed CTL terminal description
25.Dec.2014	003	Change TO220CP-V5 and TO220FP-5(V5) photos of the first page.
5.Sep.2018	004	Page-5 revised from $R_1=2.2k\Omega$, $R_2=6.8k\Omega$ to $R_1=2.0k\Omega$, $R_2=3.4k\Omega$ and Fig.2,3 Page-7 revised Fig.11,12 Page-15 to 19 revised Physical Dimension Tape and Reel Information. TO220FP-5 and TO220FP-5 V5 are changed package width from $4.5+0.3$, -0.1 to 4.5 ± 0.1 Page-13 added measurement method of stable operating region.

Notice

Precaution on using ROHM Products

- Our Products are designed and manufactured for application in ordinary electronic equipment (such as AV equipment, OA equipment, telecommunication equipment, home electronic appliances, amusement equipment, etc.). If you intend to use our Products in devices requiring extremely high reliability (such as medical equipment ^(Note 1), transport equipment, traffic equipment, aircraft/spacecraft, nuclear power controllers, fuel controllers, car equipment including car accessories, safety devices, etc.) and whose malfunction or failure may cause loss of human life, bodily injury or serious damage to property ("Specific Applications"), please consult with the ROHM sales representative in advance. Unless otherwise agreed in writing by ROHM in advance, ROHM shall not be in any way responsible or liable for any damages, expenses or losses incurred by you or third parties arising from the use of any ROHM's Products for Specific Applications.

(Note1) Medical Equipment Classification of the Specific Applications

JAPAN	USA	EU	CHINA
CLASS III	CLASS III	CLASS II b	CLASS III
CLASS IV		CLASS III	

- ROHM designs and manufactures its Products subject to strict quality control system. However, semiconductor products can fail or malfunction at a certain rate. Please be sure to implement, at your own responsibilities, adequate safety measures including but not limited to fail-safe design against the physical injury, damage to any property, which a failure or malfunction of our Products may cause. The following are examples of safety measures:
 - Installation of protection circuits or other protective devices to improve system safety
 - Installation of redundant circuits to reduce the impact of single or multiple circuit failure
- Our Products are designed and manufactured for use under standard conditions and not under any special or extraordinary environments or conditions, as exemplified below. Accordingly, ROHM shall not be in any way responsible or liable for any damages, expenses or losses arising from the use of any ROHM's Products under any special or extraordinary environments or conditions. If you intend to use our Products under any special or extraordinary environments or conditions (as exemplified below), your independent verification and confirmation of product performance, reliability, etc. prior to use, must be necessary:
 - Use of our Products in any types of liquid, including water, oils, chemicals, and organic solvents
 - Use of our Products outdoors or in places where the Products are exposed to direct sunlight or dust
 - Use of our Products in places where the Products are exposed to sea wind or corrosive gases, including Cl₂, H₂S, NH₃, SO₂, and NO₂
 - Use of our Products in places where the Products are exposed to static electricity or electromagnetic waves
 - Use of our Products in proximity to heat-producing components, plastic cords, or other flammable items
 - Sealing or coating our Products with resin or other coating materials
 - Use of our Products without cleaning residue of flux (even if you use no-clean type fluxes, cleaning residue of flux is recommended); or Washing our Products by using water or water-soluble cleaning agents for cleaning residue after soldering
 - Use of the Products in places subject to dew condensation
- The Products are not subject to radiation-proof design.
- Please verify and confirm characteristics of the final or mounted products in using the Products.
- In particular, if a transient load (a large amount of load applied in a short period of time, such as pulse. is applied, confirmation of performance characteristics after on-board mounting is strongly recommended. Avoid applying power exceeding normal rated power; exceeding the power rating under steady-state loading condition may negatively affect product performance and reliability.
- De-rate Power Dissipation depending on ambient temperature. When used in sealed area, confirm that it is the use in the range that does not exceed the maximum junction temperature.
- Confirm that operation temperature is within the specified range described in the product specification.
- ROHM shall not be in any way responsible or liable for failure induced under deviant condition from what is defined in this document.

Precaution for Mounting / Circuit board design

- When a highly active halogenous (chlorine, bromine, etc.) flux is used, the residue of flux may negatively affect product performance and reliability.
- In principle, the reflow soldering method must be used on a surface-mount products, the flow soldering method must be used on a through hole mount products. If the flow soldering method is preferred on a surface-mount products, please consult with the ROHM representative in advance.

For details, please refer to ROHM Mounting specification

Precautions Regarding Application Examples and External Circuits

1. If change is made to the constant of an external circuit, please allow a sufficient margin considering variations of the characteristics of the Products and external components, including transient characteristics, as well as static characteristics.
2. You agree that application notes, reference designs, and associated data and information contained in this document are presented only as guidance for Products use. Therefore, in case you use such information, you are solely responsible for it and you must exercise your own independent verification and judgment in the use of such information contained in this document. ROHM shall not be in any way responsible or liable for any damages, expenses or losses incurred by you or third parties arising from the use of such information.

Precaution for Electrostatic

This Product is electrostatic sensitive product, which may be damaged due to electrostatic discharge. Please take proper caution in your manufacturing process and storage so that voltage exceeding the Products maximum rating will not be applied to Products. Please take special care under dry condition (e.g. Grounding of human body / equipment / solder iron, isolation from charged objects, setting of Ionizer, friction prevention and temperature / humidity control).

Precaution for Storage / Transportation

1. Product performance and soldered connections may deteriorate if the Products are stored in the places where:
 - [a] the Products are exposed to sea winds or corrosive gases, including Cl₂, H₂S, NH₃, SO₂, and NO₂
 - [b] the temperature or humidity exceeds those recommended by ROHM
 - [c] the Products are exposed to direct sunshine or condensation
 - [d] the Products are exposed to high Electrostatic
2. Even under ROHM recommended storage condition, solderability of products out of recommended storage time period may be degraded. It is strongly recommended to confirm solderability before using Products of which storage time is exceeding the recommended storage time period.
3. Store / transport cartons in the correct direction, which is indicated on a carton with a symbol. Otherwise bent leads may occur due to excessive stress applied when dropping of a carton.
4. Use Products within the specified time after opening a humidity barrier bag. Baking is required before using Products of which storage time is exceeding the recommended storage time period.

Precaution for Product Label

A two-dimensional barcode printed on ROHM Products label is for ROHM's internal use only.

Precaution for Disposition

When disposing Products please dispose them properly using an authorized industry waste company.

Precaution for Foreign Exchange and Foreign Trade act

Since concerned goods might be fallen under listed items of export control prescribed by Foreign exchange and Foreign trade act, please consult with ROHM in case of export.

Precaution Regarding Intellectual Property Rights

1. All information and data including but not limited to application example contained in this document is for reference only. ROHM does not warrant that foregoing information or data will not infringe any intellectual property rights or any other rights of any third party regarding such information or data.
2. ROHM shall not have any obligations where the claims, actions or demands arising from the combination of the Products with other articles such as components, circuits, systems or external equipment (including software).
3. No license, expressly or implied, is granted hereby under any intellectual property rights or other rights of ROHM or any third parties with respect to the Products or the information contained in this document. Provided, however, that ROHM will not assert its intellectual property rights or other rights against you or your customers to the extent necessary to manufacture or sell products containing the Products, subject to the terms and conditions herein.

Other Precaution



1. This document may not be reprinted or reproduced, in whole or in part, without prior written consent of ROHM.
2. The Products may not be disassembled, converted, modified, reproduced or otherwise changed without prior written consent of ROHM.
3. In no event shall you use in any way whatsoever the Products and the related technical information contained in the Products or this document for any military purposes, including but not limited to, the development of mass-destruction weapons.
4. The proper names of companies or products described in this document are trademarks or registered trademarks of ROHM, its affiliated companies or third parties.

General Precaution





1. Before you use our Products, you are requested to carefully read this document and fully understand its contents. ROHM shall not be in any way responsible or liable for failure, malfunction or accident arising from the use of any ROHM's Products against warning, caution or note contained in this document.
2. All information contained in this document is current as of the issuing date and subject to change without any prior notice. Before purchasing or using ROHM's Products, please confirm the latest information with a ROHM sales representative.
3. The information contained in this document is provided on an "as is" basis and ROHM does not warrant that all information contained in this document is accurate and/or error-free. ROHM shall not be in any way responsible or liable for any damages, expenses or losses incurred by you or third parties resulting from inaccuracy or errors of or concerning such information.

Looking for pricing, stock, or lifecycle information?

Click below to explore more details on WIN SOURCE:

-  [View BA00CC0WFP-E2 on WIN SOURCE](#)
-  [Rohm Semiconductor](#) Information

Optimize Your Supply Chain with WIN SOURCE Solutions

-  Global Sourcing Solution
-  Obsolete Management
-  Cost Control Management
-  Shortage Management
-  Alternative Solution
-  Excess Inventory Management