

Dual-Output (Fixed/Variable) LDO Regulators

BA3259HFP BA30E00WHFP

●General Description

The BA3259HFP and BA30E00WHFP are 2-output, low-saturation regulators. These units have both a 3.3 V fixed output as well as a variable output with a voltage accuracy of $\pm 2\%$, and incorporate an overcurrent protection circuit to prevent IC destruction due to output shorting along with a TSD (Thermal Shut Down) circuit to protect the IC from thermal destruction caused by overloading.

●Features

- Output voltage accuracy: $\pm 2\%$.
- Reference voltage accuracy: $\pm 2\%$
- Ceramic capacitor can be used to prevent output oscillation (BA3259HFP)
- Low dissipation with two voltage input supported (BA30E00WHFP)
- Built-in thermal shutdown circuit
- Built-in overcurrent protection circuit

●Key Specifications

- Input Power Supply Voltage:

BA3259HFP	14.0V(Max.)
BA30E00WHFP	16.0V(Max.)
- Output Voltage type: V_{O1} Fixed
 V_{O2} Variable
- Output Current:

BA3259HFP	1A (MAX)
BA30E00WHFP	0.6A (MAX)
- Operating temperature range:

BA3259HFP	0 to 85°C
BA30E00WHFP	-25 to 105°C

●Packages

- | | |
|------|--------------------------------|
| | W (Typ.) x D (Typ.) x H (Max.) |
| HRP5 | 9.395mm x 10.54mm x 2.005mm |
| HRP7 | 9.395mm x 10.54mm x 2.005mm |

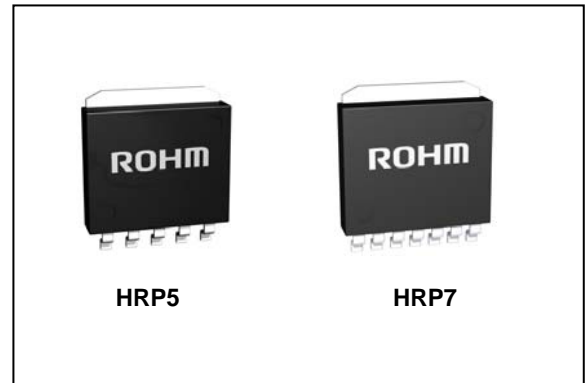

●Applications

Available to all commercial devices, such as FPD, TV, and PC sets besides DSP power supplies for DVD and CD sets.

●Ordering Information

B A 3 x x x H F P	-	TR
Part Number	Package HFP:HRP5 HRP7	Packaging and forming specification TR: Embossed tape and reel

●Lineup

Maximum Output Current (Max.)	Output Voltage 1 (Typ.)	Output Voltage 2 (Typ.)	Package		Orderable Part Number
1.0A	3.3V	0.8 to 3.3V	HRP5	Reel of 2000	BA3259HFP-TR
0.6A	3.3V	0.8 to 3.3V	HRP7	Reel of 2000	BA30E00WHFP-TR

○Product structure : Silicon monolithic integrated circuit ○This product is not designed protection against radioactive rays.

●Block Diagrams / Standard Example Application Circuits / Pin Configurations / Pin Descriptions

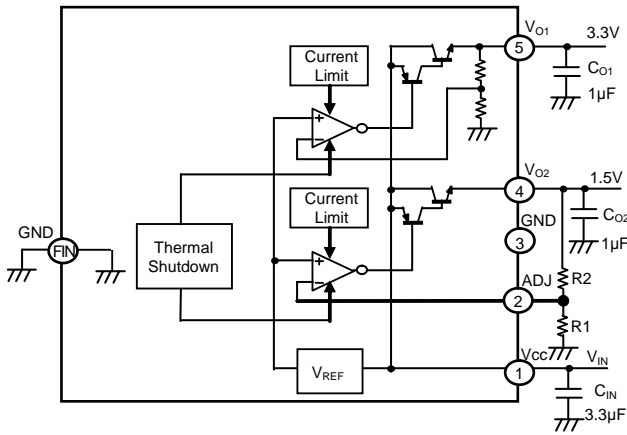

Fig.1 BA3259HFP Block Diagram

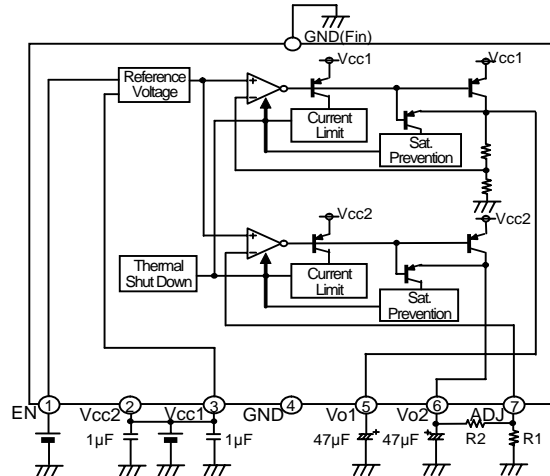

Fig.2 BA30E00WHFP Block Diagram

Pin No.	Pin name	Function
1	V _{CC}	Power supply pin
2	ADJ	Variable output voltage detection pin
3	GND	GND pin
4	Vo ₂	Variable output pin
5	Vo ₁	3.3 V output pin
FIN	GND	GND pin

Pin No.	Pin name	Function
1	EN	Output on/off control pin: High active
2	V _{CC2}	Power supply pin 2
3	V _{CC1}	Power supply pin 1
4	GND	GND pin
5	Vo ₁	Power supply pin for 3.3 V output
6	Vo ₂	Variable output voltage detection pin (0.8 V to 3.3 V)
7	ADJ	Variable output voltage detection pin
FIN	GND	GND pin

PIN	External capacitor setting range
V _{CC} (1Pin)	Approximately 3.3μF
Vo ₁ (5Pin)	1 μF to 1000 μF
Vo ₂ (4Pin)	1 μF to 1000 μF

TOP VIEW

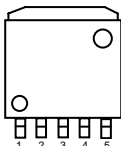

HRP5

PIN	External capacitor setting range
V _{CC1} (3Pin)	Approximately 1 μF
V _{CC2} (2Pin)	Approximately 1 μF
Vo ₁ (5Pin)	47 μF to 1000 μF
Vo ₂ (6Pin)	47 μF to 1000 μF

TOP VIEW

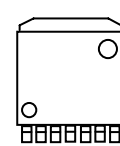

HRP7

●Absolute Maximum Ratings

BA3259HFP

Parameter	Symbol	Ratings	Units
Applied voltage	V _{CC}	15 ^{*1}	V
Power dissipation	P _d	2300 ^{*2}	mW
Operating temperature range	Topr	0 to 85	°C
Ambient storage temperature range	Tstg	-55 to 150	°C
Maximum junction temperature	Tjmax	150	°C

BA30E00WHFP

Parameter	Symbol	Ratings	Units
Applied voltage	V _{CC}	18 ^{*1}	V
Power dissipation	P _d	2300 ^{*2}	mW
Operating temperature range	Topr	-25 to 105	°C
Ambient storage temperature range	Tstg	-55 to 150	°C
Maximum junction temperature	Tjmax	150	°C

*1 Must not exceed P_d.

*2 Derated at 18.4 mW/°C at T_a>25°C when mounted on a glass epoxy board (70 mm × 70 mm × 1.6 mm).

● Recommended Operating Ratings

BA3259HFP

Parameter	Symbol	Ratings			Unit
		Min.	Typ.	Max.	
Input power supply voltage	Vcc	4.75	-	14.0	V
3.3 V output current	Io1	-	-	1	A
Variable output current	Io2	-	-	1	A

BA30E00WHFP

Parameter	Symbol	Ratings			Unit
		Min.	Typ.	Max.	
Input power supply voltage 1	Vcc1	4.1	-	16.0	V
Input power supply voltage 2	Vcc2	2.8	-	Vcc1	V
3.3 V output current	Io1	-	-	0.6	A
Variable output current	Io2	-	-	0.6	A

● Electrical Characteristics

OBA3259HFP (Unless otherwise specified, Ta=25°C, Vcc=5 V, R1=R2=5 kΩ)

Parameter	Symbol	Limits			Unit	Conditions
		Min.	Typ.	Max.		
Circuit current	I _B	-	3	5	mA	Io1=0mA, Io2=0mA
[3.3 V Output Block]						
Output voltage 1	Vo1	3.234	3.300	3.366	V	Io1=50mA
Minimum I/O voltage difference 1	ΔVd1	-	1.1	1.3	V	Io1=1 A, Vcc=3.8V
Current capability 1	Io1	1.0	-	-	A	
Ripple rejection 1	R.R.1	46	52	-	dB	f=120Hz, ein=0.5Vp-p, Io1=5mA
Input stability 1	ΔVLINE1	-	5	15	mV	Vcc=4.75→14V, Io1=5mA
Load stability 1	ΔVLOAD1	-	5	20	mV	Io1=5mA→1 A
Temperature coefficient of output voltage 1 ^{*3}	Tcvo1	-	±0.01	-	%/°C	Io1=5mA, Tj=0°C to 85°C
[Variable output]						
Reference voltage	VREF	0.784	0.800	0.816	V	Io2=50mA
Minimum I/O voltage difference 2	ΔVd2	-	1.1	1.3	V	Io2=1 A
Current capability 2	Io2	1.0	-	-	A	
Ripple rejection 2	R.R.2	46	52	-	dB	f=120Hz, ein=0.5Vp-p, Io2=5mA
Input stability 2	ΔVLINE2	-	5	15	mV	Vcc=4.75→14V, Io2=5mA
Load stability 2	ΔVLOAD2	-	5	20	mV	Io2=5mA→1 A
Temperature coefficient of output voltage 2 ^{*3}	Tcvo2	-	±0.01	-	%/°C	Io2=5mA, Tj=0°C to 85°C
Variable pin current	IADJ	-	0.05	1.0	μA	VADJ=0.85V

*3 Not 100% tested

●Electrical Characteristics - continued

OBA30E00WHFP (Unless otherwise specified, Ta=25°C, Vcc1=Vcc2=VEN=5 V, R1=50kΩ, R2=62.5kΩ)

Parameter	Symbol	Limits			Unit	Conditions
		Min.	Typ.	Max.		
Bias current	Ib	-	0.7	1.6	mA	Io1=0mA, Io2=0mA
Standby current	IST	-	0	10	μA	VEN=GND
EN pin on voltage	VON	2.0	-	-	V	Active mode
EN pin off voltage	VOFF	-	-	0.8	V	Standby mode
EN pin current	IEN	-	50	100	μA	VEN=3.3V
[3.3 V output]						
Output voltage 1	Vo1	3.234	3.300	3.366	V	Io1=50mA
Minimum I/O voltage difference 1	ΔVd1	-	0.30	0.60	V	Io1=300mA, Vcc=3.135V
Output current capacity 1	Io1	0.6	-	-	A	
Ripple rejection 1	R.R.1	-	68	-	dB	f=120Hz, ein=1Vp-p, Io1=100mA
Input stability 1	Reg.I1	-	5	30	mV	Vcc1=4.1→16V, Io1=50mA
Load stability 1-1	Reg.L1-1	-	30	90	mV	Io1=0mA→0.6A
Load stability 1-2	Reg.L1-2	-	30	90	mV	Vcc1=3.7V, Io1=0→0.4A
Temperature coefficient of output voltage 1 *3	Tcvo1	-	±0.01	-	%/°C	Io1=5mA, Tj=0°C to 125°C
[Variable output] (at 1.8 V)						
Reference voltage	VADJ	0.784	0.800	0.816	V	Io2=50mA
Minimum I/O voltage difference 2	ΔVd2	-	0.30	0.60	V	At Io2=3.3V Io2=300mA, Vcc1=Vcc2=3.135V
Output current capacity 2	Io2	0.6	-	-	A	
Ripple rejection 2	R.R.2	-	66	-	dB	f=120Hz, ein=1Vp-p, Io2=100mA
Input stability 2	Reg.I2	-	5	30	mV	Vcc1=Vcc2=4.1V→16V, Io2=50mA
Load stability 2	Reg.L2	-	30	90	mV	Io2=0mA→0.6A
Temperature coefficient of output voltage 2 *3	Tcvo2	-	±0.01	-	%/°C	Io2=5mA, Tj=0°C to 125°C

*3 Not 100% tested

● Typical Performance Curves

BA3259HFP (Unless otherwise specified, Ta=25°C, Vcc=5 V)

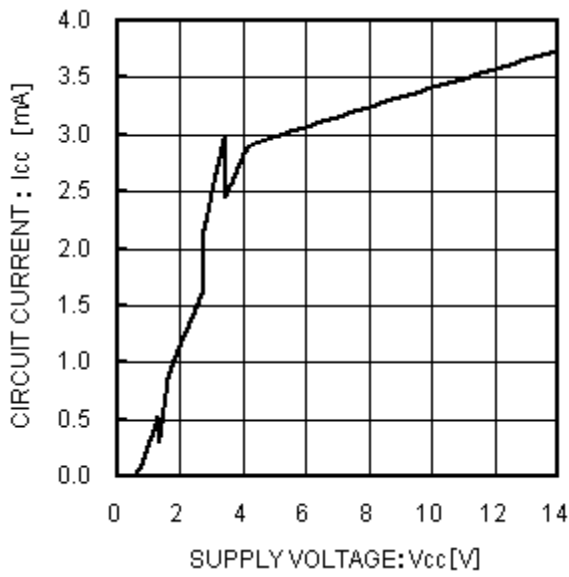

Fig.3
Circuit Current (with no load)

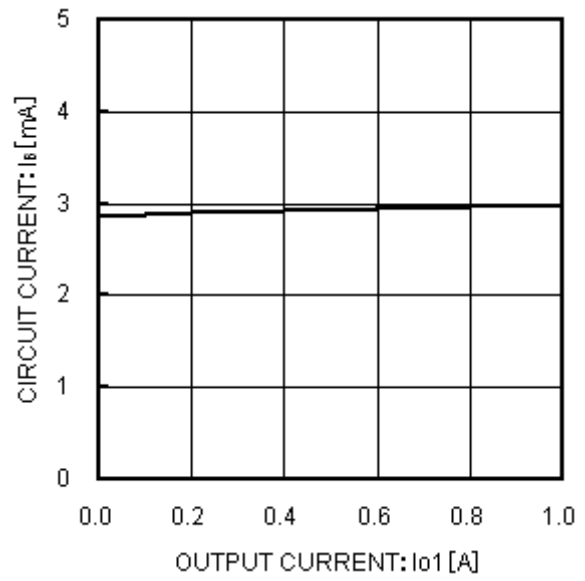

Fig.4
Circuit Current vs Load Current I_o

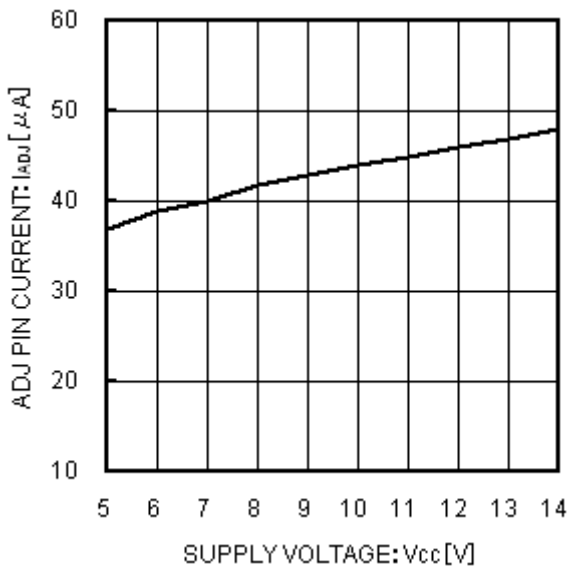

Fig.5
ADJ Pin Outflow Current

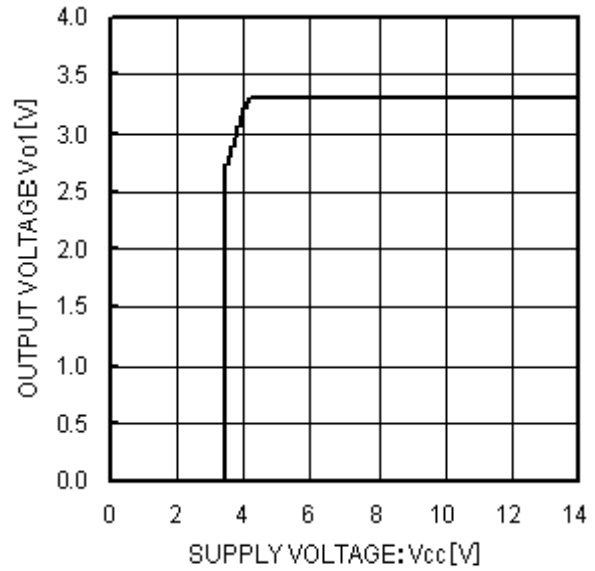

Fig.6
Input Stability
(3.3 V output with no load)

● Typical Performance Curves - continued

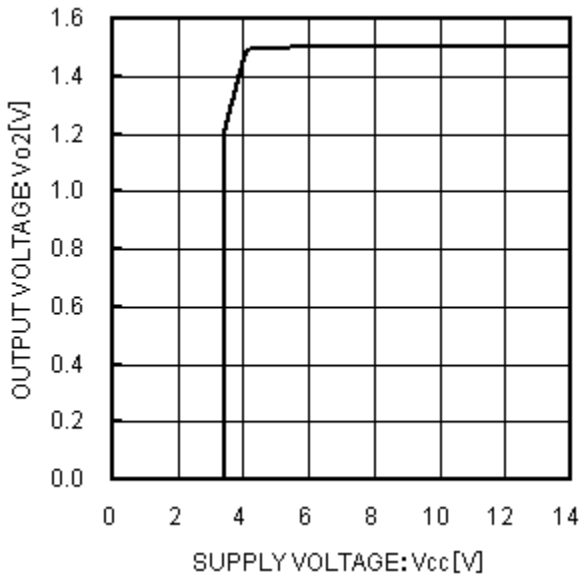

Fig.7
Input Stability
(Variable output with no load)

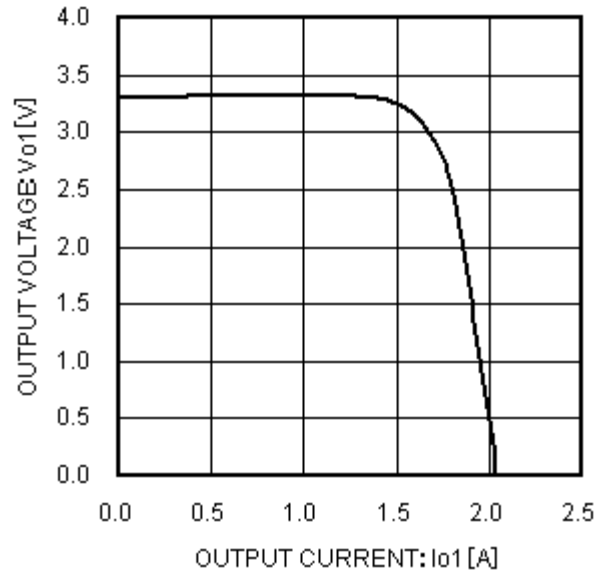

Fig.8
Load Stability
(3.3 V output)

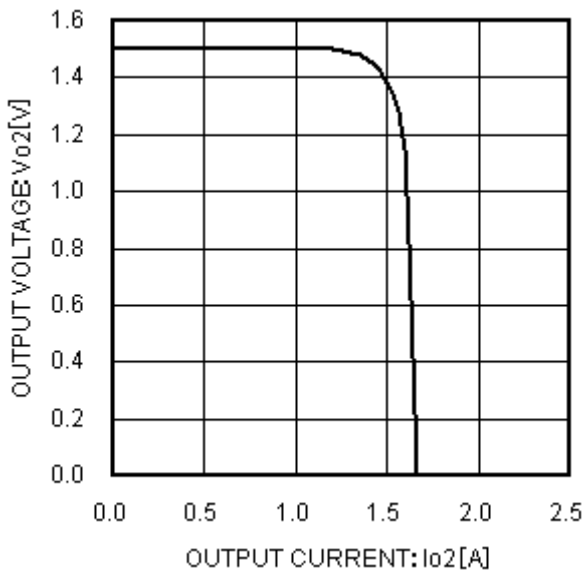

Fig.9
Load Stability
(Variable output: 1.5 V)

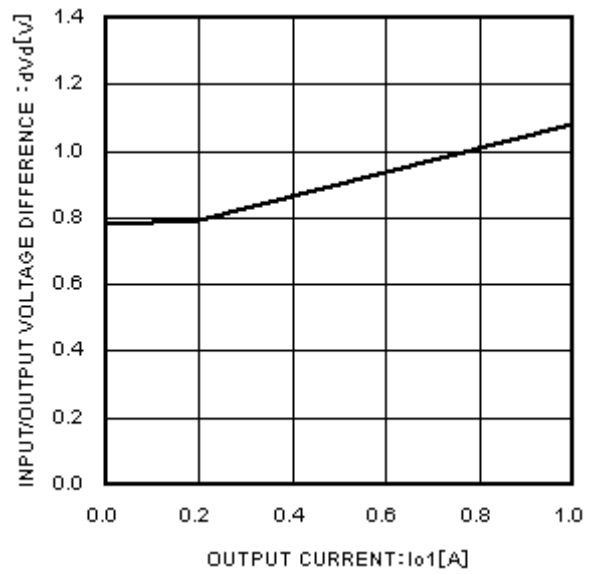

Fig.10
I/O Voltage Difference (3.3 V output)
(3.3 V output, $I_{o1}=0\text{ A} \rightarrow 1\text{ A}$)

● Typical Performance Curves - continued

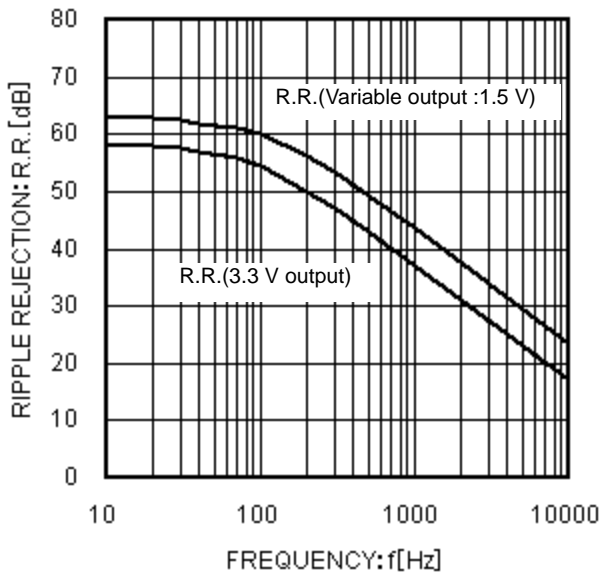

Fig.11
R.R.

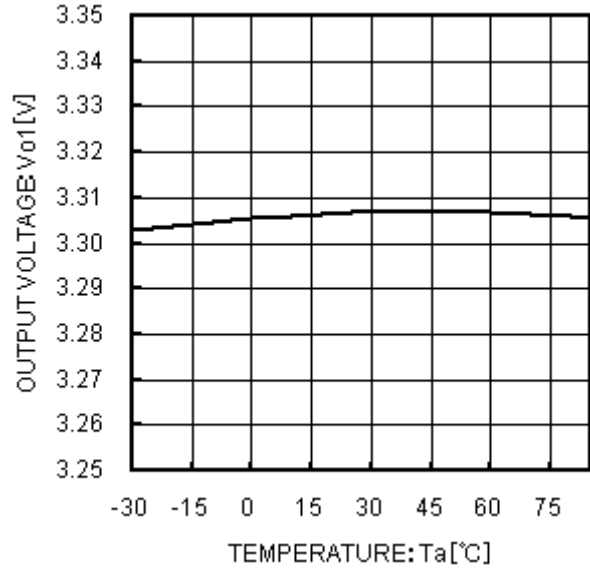

Fig.12
Output Voltage vs Temperature
(3.3 V output)

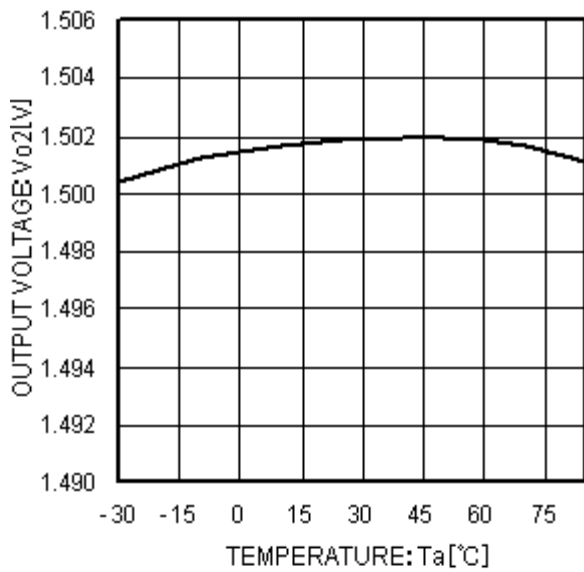

Fig.13
Output Voltage vs Temperature
(Variable output: 1.5 V)

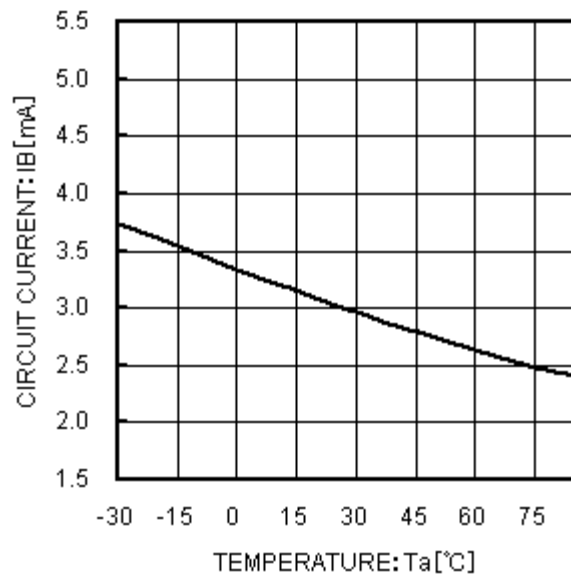

Fig.14
Circuit Current vs Temperature

● Typical Performance Curves - continued

BA30E00WHFP (Unless otherwise specified, $T_a=25^\circ\text{C}$, $V_{cc1}=V_{cc2}=5\text{V}$)

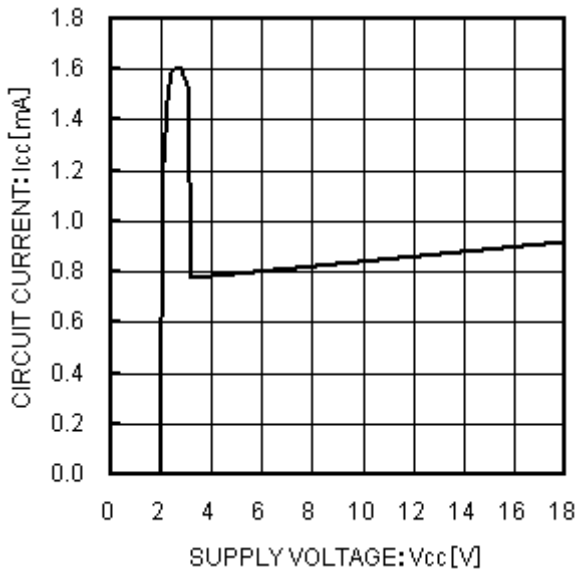

Fig.15
Circuit Current
(with no load)

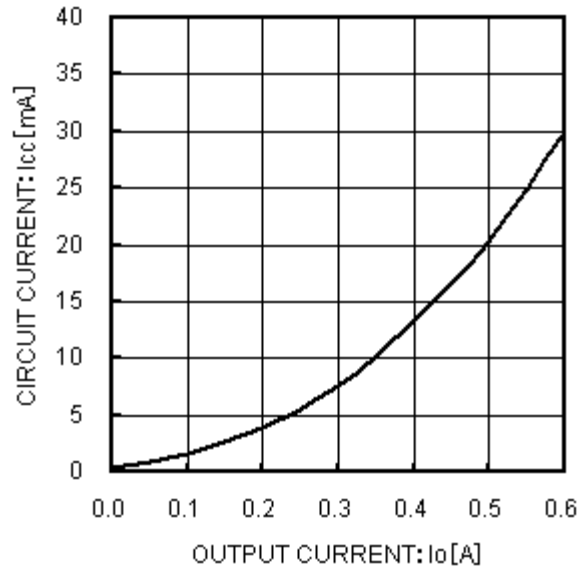

Fig.16
Circuit Current vs Load Current I_o
($I_o=0 \rightarrow 600\text{ mA}$)

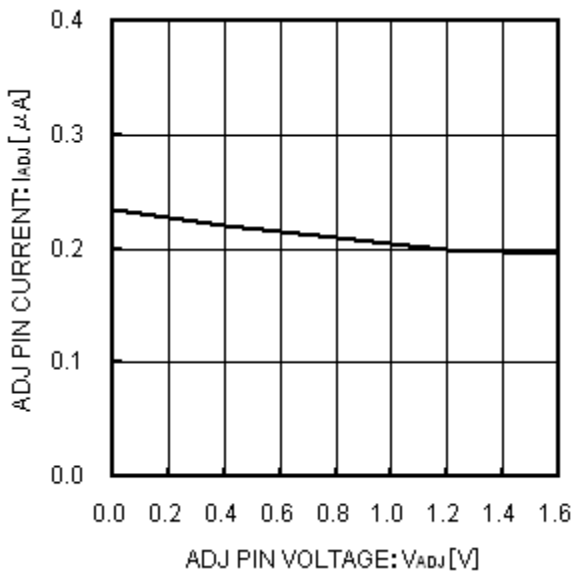

Fig.17
ADJ Pin Source Current

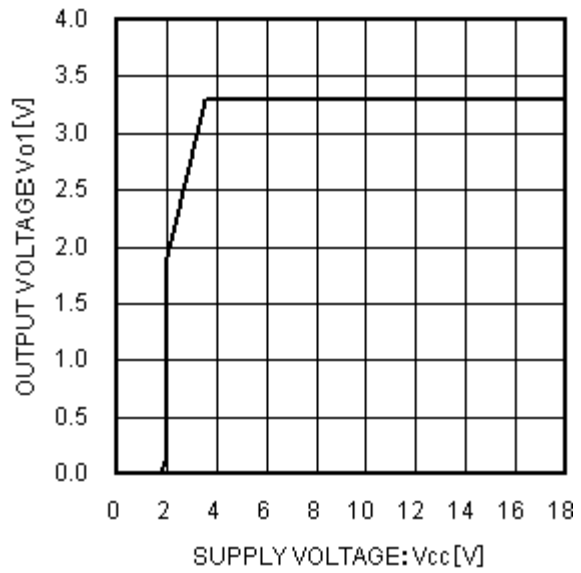

Fig.18
Input Stability
(3.3 V output $I_o=600\text{ mA}$)

● Typical Performance Curves - continued

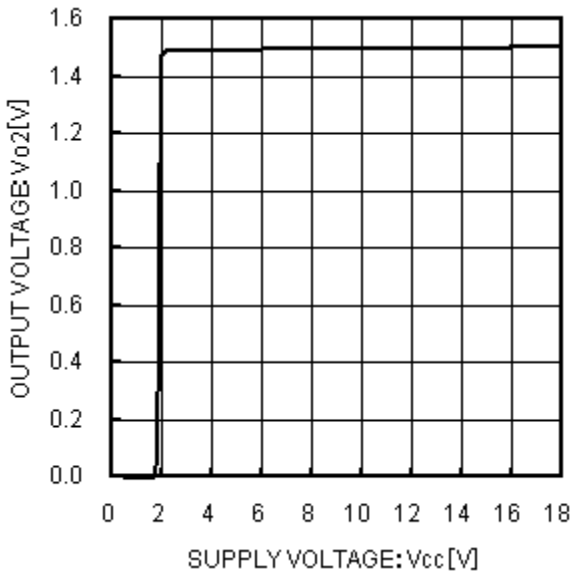

Fig.19
Input Stability
(Variable output: 1.8 V)

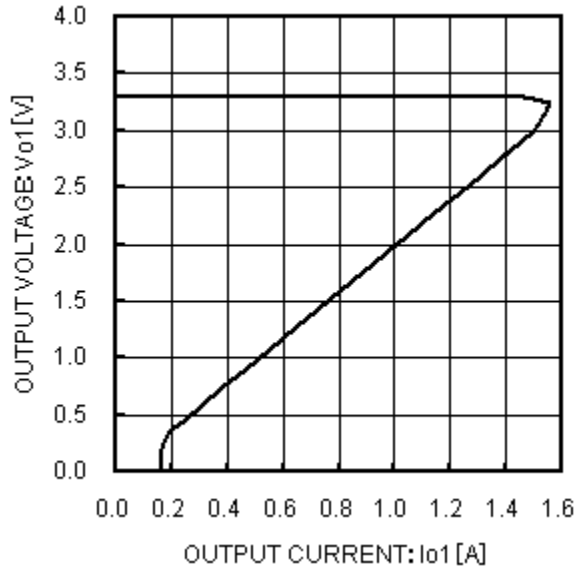

Fig.20
Load Stability
(3.3 V output)

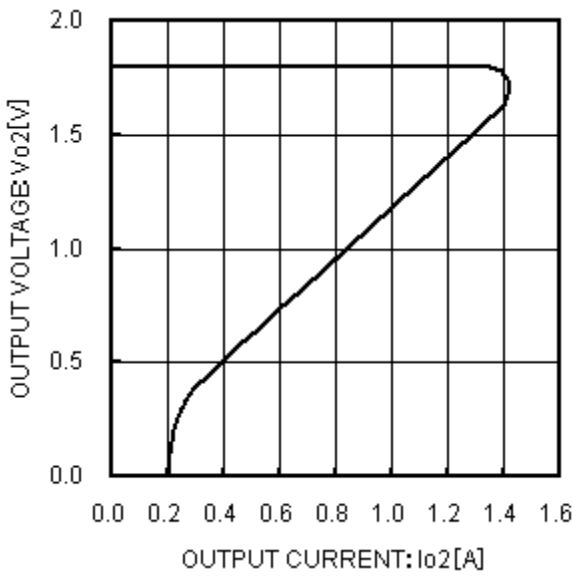

Fig.21
Load Stability
(Variable output: 1.8 V)

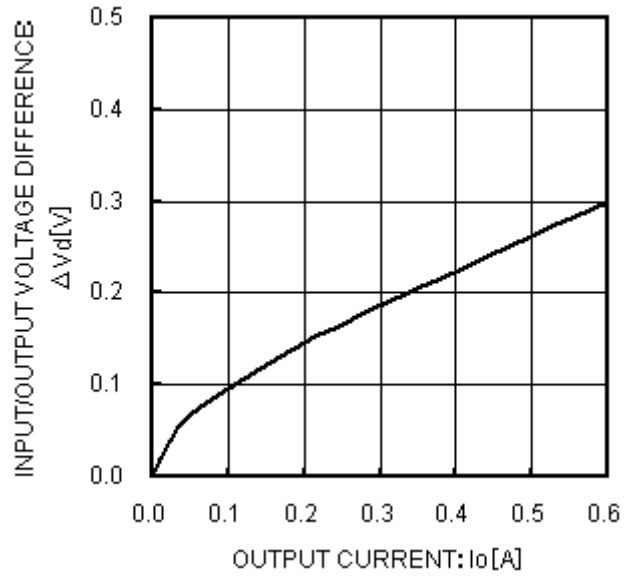

Fig.22
I/O Voltage Difference
($V_{cc}=3.135$ V, 3.3 V output)

● Typical Performance Curves - continued

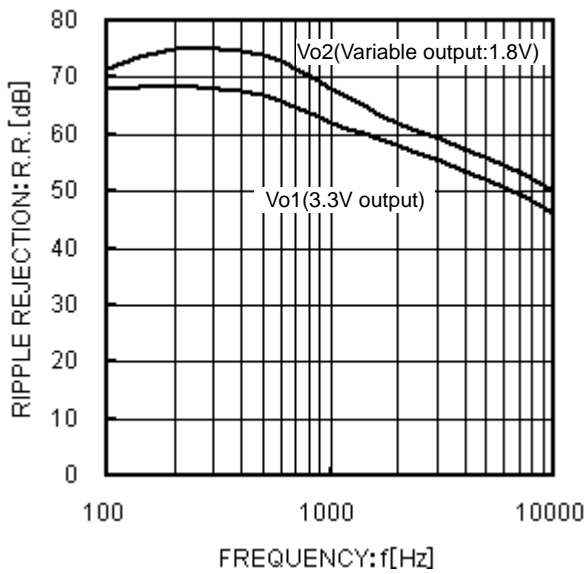

Fig.23
R.R.
($e_{in}=1$ Vp-p, $I_o=100$ mA)

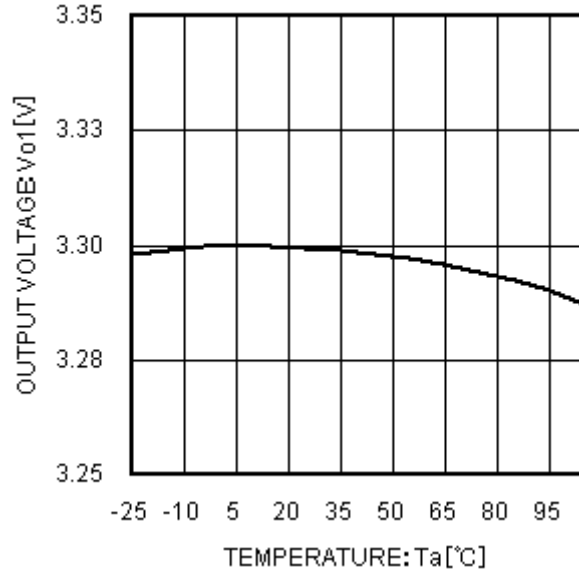

Fig.24
Output Voltage vs Temperature
(3.3 V output)

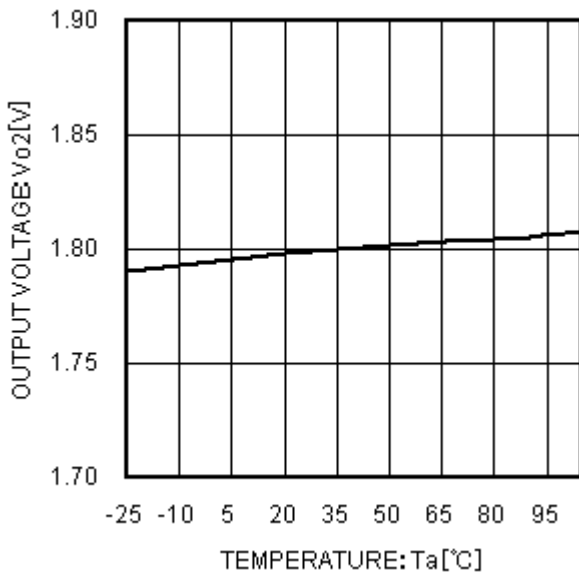

Fig.25
Output Voltage vs Temperature
(Variable output: 1.8 V)

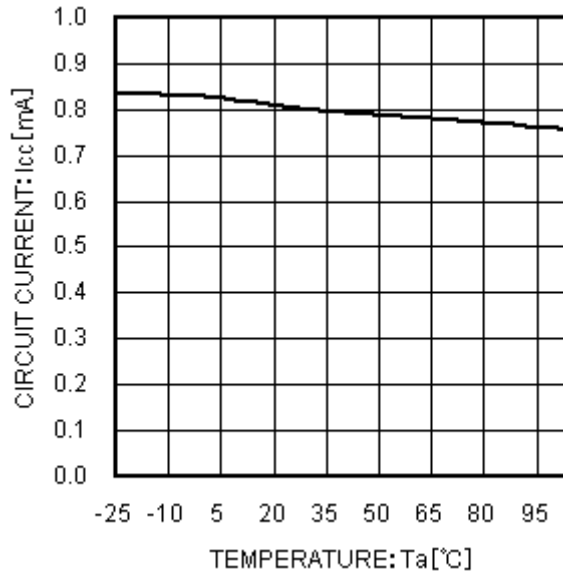

Fig.26
Circuit Current vs Temperature
($I_o=0$ mA)

Application Information

●Setting the Output Voltage Vo2

The following output voltage setting method applies to the variable output pin.

$$Vo2 = V_{ADJ} \times \left(1 + \frac{R2}{R1} \right) - R2 \times I_{ADJ}$$

V_{ADJ}: Output feedback reference voltage (0.8 V typ.)

I_{ADJ}: ADJ pin source current (0.05μA typ.: BA3259HFP)
(0.2μA typ.: BA30E00WHFP)

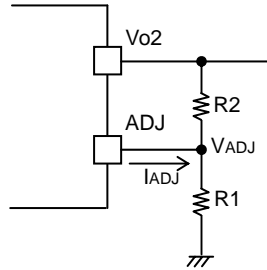

R1
BA3259HFP: 1 kΩ to 10 kΩ
BA30E00HFP: 1 kΩ to 5 kΩ
The above is recommended.

Note: Connect R1 and R2 to make output voltage settings as shown in Fig.1 and Fig.2. Keep in mind that the offset voltage caused by the current (I_{ADJ}) flowing out of the ADJ pin will become high if higher resistance is used.

●Function Explanation

1) Two-input power supply (BA30E00WHFP)

The input voltages (V_{cc1} and V_{cc2}) supply power to two outputs (Vo₁ and Vo₂, respectively). The power dissipation between the input and output pins can be suppressed for each output according to usage.

Efficiency comparison:

5V single input vs. 5V/3V two inputs

●Regulator with single input and two outputs

●Regulator with two inputs and two outputs

(Vo₂=1.8V, Io₁=Io₂=0.3A)

Conventional

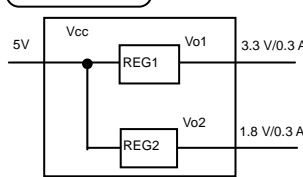

Power loss between input and output
(V_{cc} - Vo₁) × Io₁ + (V_{cc} - Vo₂) × Io₂
= (5 - 3.3) × 0.3 + (5 - 1.8) × 0.3
= 0.51W + 0.96W
= 1.47W
→ Single 5V input results in decreased efficiency

Current

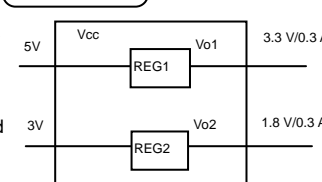

Power loss between input and output
(V_{cc1} - Vo₁) × Io₁ + (V_{cc2} - Vo₂) × Io₂
= (5 - 3.3) × 0.3 + (5 - 1.8) × 0.3
= 0.51W + 0.36W
= 0.87W
→ Additional 3V input improves efficiency
Reduced power loss by 0.6W.

2) Standby function (BA30E00WHFP)

The standby function is operated through the EN pin. Output is turned on at 2.0 V or higher and turned off at 0.8 V or lower.

●Power Dissipation

If the IC is used under the conditions of excess of the power dissipation, the chip temperature will rise, which will have an adverse effect on the electrical characteristics of the IC, such as a reduction in current capability. Furthermore, if the temperature exceeds T_{jmax}, element deterioration or damage may occur. Implement proper thermal designs to ensure that the power dissipation is within the permissible range in order to prevent instantaneous IC damage resulting from heat and maintain the reliability of the IC for long-term operation. Refer to the power derating characteristics curves in Fig.27.

• Power Consumption Pc (W) Calculation Method:

OBA3259HFP

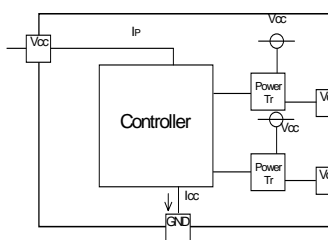

• Power consumption of 3.3 V power transistor
Pc1=(V_{cc} - 3.3) × Io1
• Power consumption of Vo2 power transistor
Pc2=(V_{cc} - Vo2) × Io2
• Power consumption by circuit current
Pc3=V_{cc} × I_{cc}
Pc=Pc1 + Pc2 + Pc3
* V_{cc}: Applied voltage
Io1: Load current on Vo1 side
Io2: Load current on Vo2 side
I_{cc}: Circuit current

OBA30E00WHFP

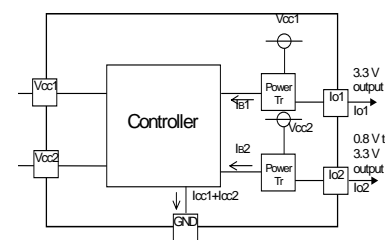

• Power consumption of power transistor on Vo1 (3.3 V output)
Pc1=(V_{cc1} - Vo1) × Io1
• Power consumption of power transistor on Vo2 (variable output)
Pc2=(V_{cc2} - Vo2) × Io2
• Power consumption by circuit current
Pc3=V_{cc1} × I_{cc1} + V_{cc2} × I_{cc2}
Pc=Pc1 + Pc2 + Pc3
* V_{cc1}, V_{cc2}: Applied voltage
Io1: Load current on 3.3 V output side
Io2: Load current on variable output side
I_{cc1}, I_{cc2}: Circuit currents

The I_{cc} (circuit current) varies with the load.

Refer to the above and implement proper thermal designs so that the IC will not be used under conditions of excess power dissipation P_d under all operating temperatures.

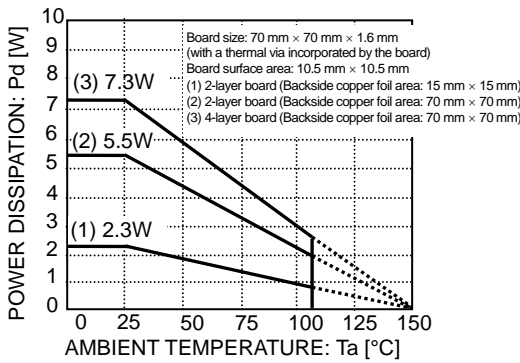

Fig.27 Ambient Temperature vs. Power Dissipation

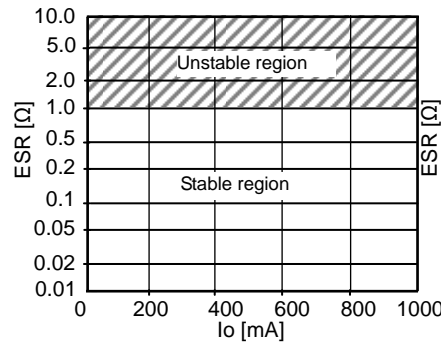

Fig.28 BA3259HFP ESR Characteristics

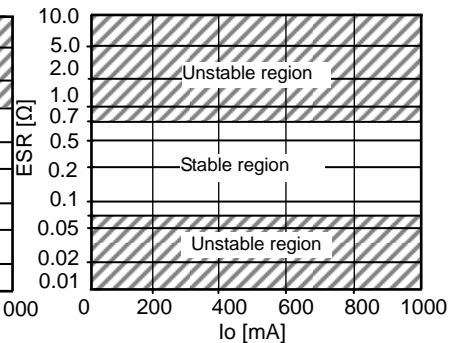

Fig.29 BA30E00WHFP ESR Characteristics

● I/O equivalence circuit

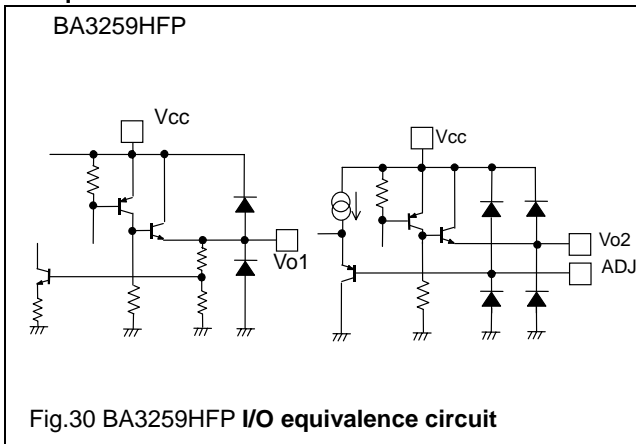

Fig.30 BA3259HFP I/O equivalence circuit

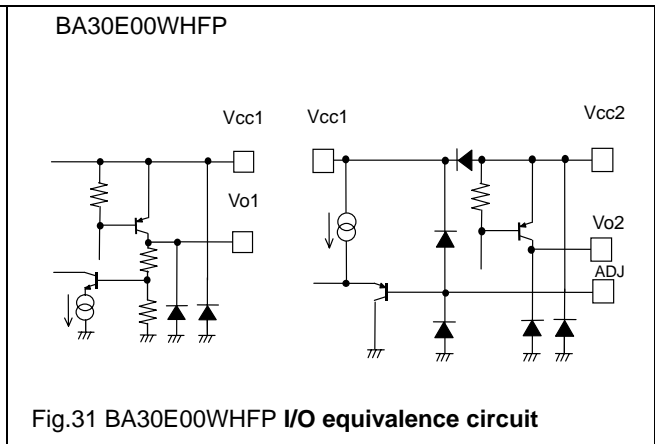

Fig.31 BA30E00WHFP I/O equivalence circuit

● Explanation of External Components

OBA3259HFP

1) Vcc (Pin 1)

It is recommended that a ceramic capacitor with a capacitance of approximately 3.3μF is placed between Vcc and GND at a position closest to the pins as possible.

2) Vo (Pins 4 and 5)

Insert a capacitor between Vo and GND in order to prevent output oscillation. The capacitor may oscillate if the capacitance changes as a result of temperature fluctuations. Therefore, it is recommended that a ceramic capacitor with a temperature coefficient of X5R or above and a maximum capacitance change (resulting from temperature fluctuations) of ±10% be used. The capacitance should be between 1μF and 1,000μF. (Refer to Fig.28.)

OBA33E00HFP

1) Vcc1 (Pin 3) and Vcc2 (Pin 2)

Insert capacitors with a capacitance of 1μF between Vcc1 and GND and Vcc2 and GND. The capacitance value will vary depending on the application. Be sure to implement designs with sufficient margins.

2) Vo1 (Pin 5) and Vo2 (Pin 6)

Insert a capacitor between Vo and GND in order to prevent oscillation. The capacitance of the capacitor may greatly vary with temperature changes, making it impossible to completely prevent oscillation. Therefore, use a tantalum aluminum electrolytic capacitor with a low ESR (Equivalent Serial Resistance) that ensures good performance characteristics at low temperatures. The output oscillates if the ESR is too high or too low. Refer to the ESR characteristics in Fig.29 and operate the IC within the stable operating region. If there is a sudden load change, use a capacitor with a higher capacitance. A capacitance between 47μF and 1,000μF is recommended.

●Operational Notes

- 1) Absolute maximum ratings
An excess in the absolute maximum ratings, such as supply voltage, temperature range of operating conditions, etc., can break down the devices, thus making impossible to identify breaking mode, such as a short circuit or an open circuit. If any over rated values will expect to exceed the absolute maximum ratings, consider adding circuit protection devices, such as fuses.
- 2) GND voltage
The potential of GND pin must be minimum potential in all operating conditions.
- 3) Thermal design
Use a thermal design that allows for a sufficient margin in light of the power dissipation (Pd) in actual operating conditions.
- 4) Inter-pin shorts and mounting errors
Use caution when positioning the IC for mounting on printed circuit boards. The IC may be damaged if there is any connection error or if pins are shorted together.
- 5) Actions in strong electromagnetic field
Use caution when using the IC in the presence of a strong electromagnetic field as doing so may cause the IC to malfunction.
- 6) Testing on application boards
When testing the IC on an application board, connecting a capacitor to a pin with low impedance subjects the IC to stress. Always discharge capacitors after each process or step. Always turn the IC's power supply off before connecting it to or removing it from a jig or fixture during the inspection process. Ground the IC during assembly steps as an antistatic measure. Use similar precaution when transporting or storing the IC.
- 7) Regarding input pin of the IC
This monolithic IC contains P+ isolation and P substrate layers between adjacent elements in order to keep them isolated. P-N junctions are formed at the intersection of these P layers with the N layers of other elements, creating a parasitic diode or transistor. For example, the relation between each potential is as follows:
When $GND > PIN A$ and $GND > PIN B$, the P-N junction operates as a parasitic diode.
When $GND > PIN B$, the P-N junction operates as a parasitic transistor.
Parasitic diodes can occur inevitable in the structure of the IC. The operation of parasitic diodes can result in mutual interference among circuits, operational faults, or physical damage. Accordingly, methods by which parasitic diodes operate, such as applying a voltage that is lower than the GND (P substrate) voltage to an input pin, should not be used.
- 8) Ground wiring patterns
When using both small signal and large current GND patterns, it is recommended to isolate the two ground patterns, placing a single ground point at the ground potential of application so that the pattern wiring resistance and voltage variations caused by large currents do not cause variations in the small signal ground voltage. Be careful not to change the GND wiring pattern of any external components, either.
- 9) Thermal Shutdown Circuit (TSD)
This IC incorporates a built-in thermal shutdown circuit for protection against thermal destruction. Should the junction temperature (Tj) reach the thermal shutdown ON temperature threshold, the TSD will be activated, turning off all output power elements. The circuit will automatically reset once the chip's temperature Tj drops below the threshold temperature. Operation of the thermal shutdown circuit presumes that the IC's absolute maximum ratings have been exceeded. Application designs should never make use of the thermal shutdown circuit.
- 10) Overcurrent protection circuit
An overcurrent protection circuit is incorporated in order to prevention destruction due to short-time overload currents. Continued use of the protection circuits should be avoided. Please note that current increases negatively impact the temperature.
- 11) Damage to the internal circuit or element may occur when the polarity of the Vcc pin is opposite to that of the other pins in applications. (I.e. Vcc is shorted with the GND pin while an external capacitor is charged.)
Use a maximum capacitance of 1000 mF for the output pins. Inserting a diode to prevent back-current flow in series with Vcc or bypass diodes between Vcc and each pin is recommended.

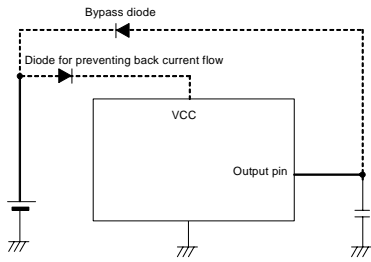

Fig.32 Bypass diode

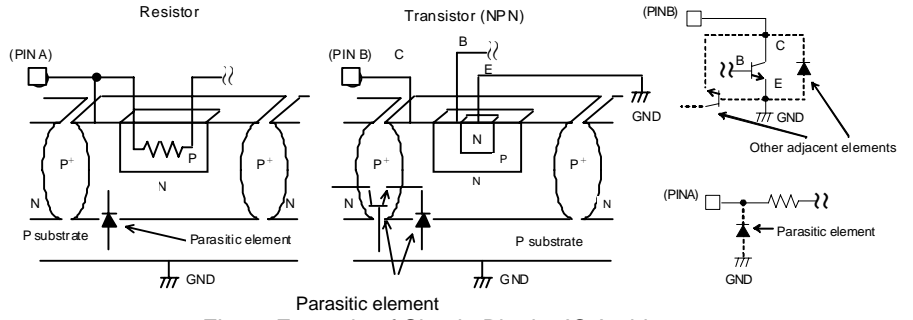

Fig.33 Example of Simple Bipolar IC Architecture

Status of this document

The Japanese version of this document is formal specification. A customer may use this translation version only for a reference to help reading the formal version.

If there are any differences in translation version of this document formal version takes priority.

●Physical Dimension Tape and Reel Information

HRP5

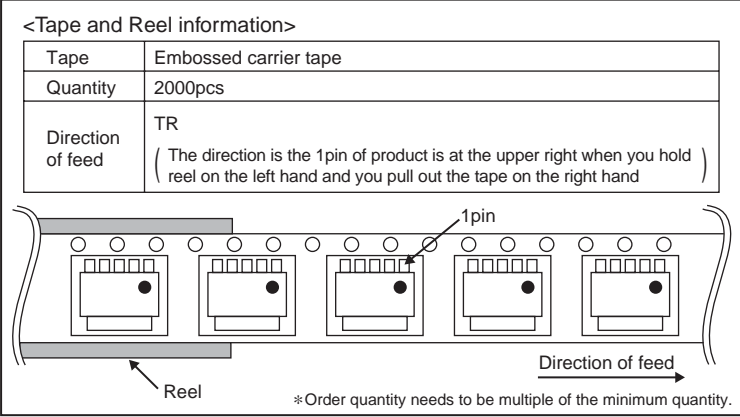
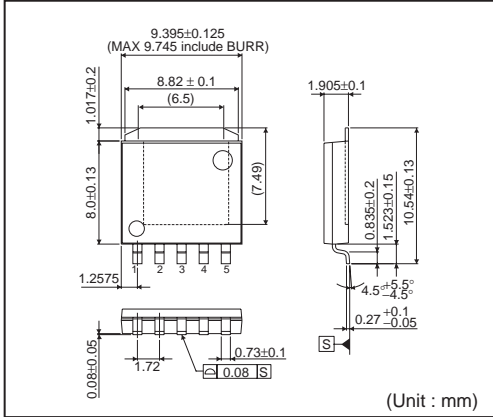

HRP7

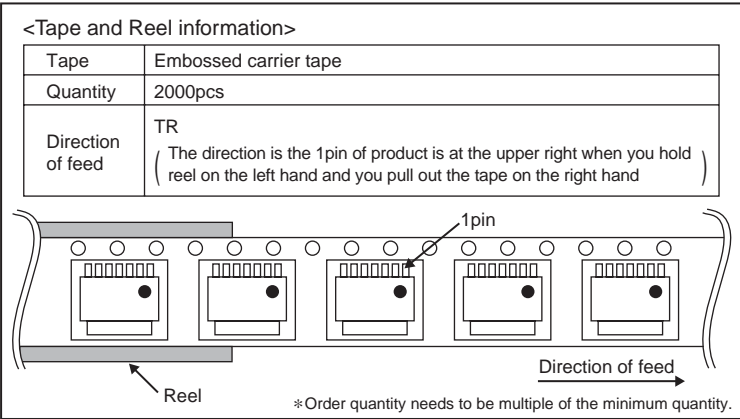
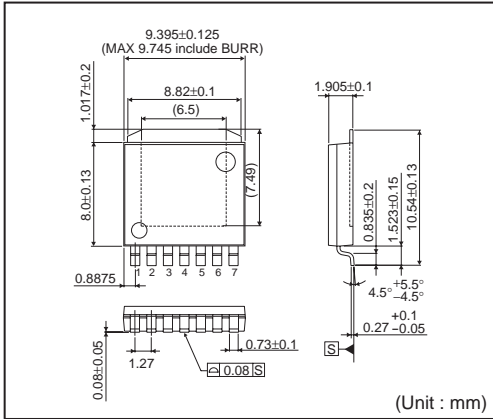

●Marking Diagrams

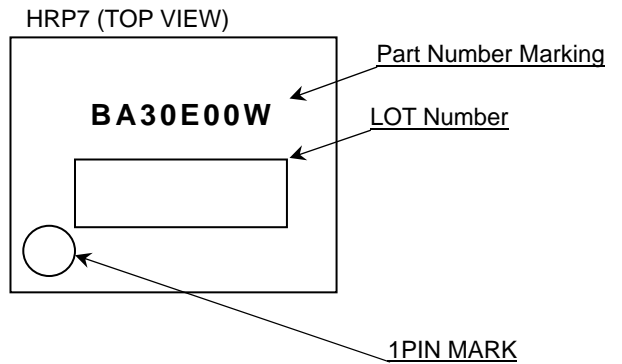
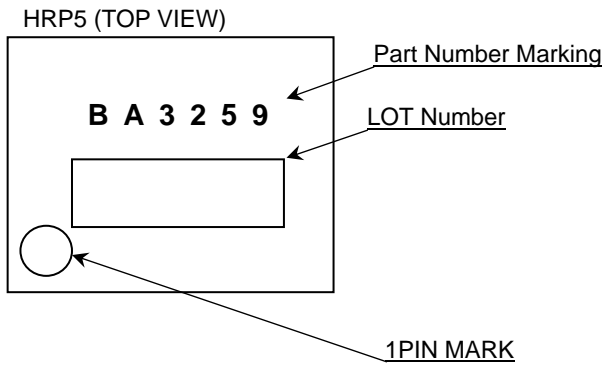

●Revision History

Date	Revision	Changes
26.Jun.2012	001	New Release

Notice

Precaution on using ROHM Products

- Our Products are designed and manufactured for application in ordinary electronic equipments (such as AV equipment, OA equipment, telecommunication equipment, home electronic appliances, amusement equipment, etc.). If you intend to use our Products in devices requiring extremely high reliability (such as medical equipment ^(Note 1), transport equipment, traffic equipment, aircraft/spacecraft, nuclear power controllers, fuel controllers, car equipment including car accessories, safety devices, etc.) and whose malfunction or failure may cause loss of human life, bodily injury or serious damage to property ("Specific Applications"), please consult with the ROHM sales representative in advance. Unless otherwise agreed in writing by ROHM in advance, ROHM shall not be in any way responsible or liable for any damages, expenses or losses incurred by you or third parties arising from the use of any ROHM's Products for Specific Applications.

(Note1) Medical Equipment Classification of the Specific Applications

JAPAN	USA	EU	CHINA
CLASS III	CLASS III	CLASS II b	CLASS III
CLASS IV		CLASS III	

- ROHM designs and manufactures its Products subject to strict quality control system. However, semiconductor products can fail or malfunction at a certain rate. Please be sure to implement, at your own responsibilities, adequate safety measures including but not limited to fail-safe design against the physical injury, damage to any property, which a failure or malfunction of our Products may cause. The following are examples of safety measures:
 - Installation of protection circuits or other protective devices to improve system safety
 - Installation of redundant circuits to reduce the impact of single or multiple circuit failure
- Our Products are designed and manufactured for use under standard conditions and not under any special or extraordinary environments or conditions, as exemplified below. Accordingly, ROHM shall not be in any way responsible or liable for any damages, expenses or losses arising from the use of any ROHM's Products under any special or extraordinary environments or conditions. If you intend to use our Products under any special or extraordinary environments or conditions (as exemplified below), your independent verification and confirmation of product performance, reliability, etc. prior to use, must be necessary:
 - Use of our Products in any types of liquid, including water, oils, chemicals, and organic solvents
 - Use of our Products outdoors or in places where the Products are exposed to direct sunlight or dust
 - Use of our Products in places where the Products are exposed to sea wind or corrosive gases, including Cl₂, H₂S, NH₃, SO₂, and NO₂
 - Use of our Products in places where the Products are exposed to static electricity or electromagnetic waves
 - Use of our Products in proximity to heat-producing components, plastic cords, or other flammable items
 - Sealing or coating our Products with resin or other coating materials
 - Use of our Products without cleaning residue of flux (even if you use no-clean type fluxes, cleaning residue of flux is recommended); or Washing our Products by using water or water-soluble cleaning agents for cleaning residue after soldering
 - Use of the Products in places subject to dew condensation
- The Products are not subject to radiation-proof design.
- Please verify and confirm characteristics of the final or mounted products in using the Products.
- In particular, if a transient load (a large amount of load applied in a short period of time, such as pulse. is applied, confirmation of performance characteristics after on-board mounting is strongly recommended. Avoid applying power exceeding normal rated power; exceeding the power rating under steady-state loading condition may negatively affect product performance and reliability.
- De-rate Power Dissipation (Pd) depending on Ambient temperature (Ta). When used in sealed area, confirm the actual ambient temperature.
- Confirm that operation temperature is within the specified range described in the product specification.
- ROHM shall not be in any way responsible or liable for failure induced under deviant condition from what is defined in this document.

Precaution for Mounting / Circuit board design

- When a highly active halogenous (chlorine, bromine, etc.) flux is used, the residue of flux may negatively affect product performance and reliability.
- In principle, the reflow soldering method must be used; if flow soldering method is preferred, please consult with the ROHM representative in advance.

For details, please refer to ROHM Mounting specification

Precautions Regarding Application Examples and External Circuits

1. If change is made to the constant of an external circuit, please allow a sufficient margin considering variations of the characteristics of the Products and external components, including transient characteristics, as well as static characteristics.
2. You agree that application notes, reference designs, and associated data and information contained in this document are presented only as guidance for Products use. Therefore, in case you use such information, you are solely responsible for it and you must exercise your own independent verification and judgment in the use of such information contained in this document. ROHM shall not be in any way responsible or liable for any damages, expenses or losses incurred by you or third parties arising from the use of such information.

Precaution for Electrostatic

This Product is electrostatic sensitive product, which may be damaged due to electrostatic discharge. Please take proper caution in your manufacturing process and storage so that voltage exceeding the Products maximum rating will not be applied to Products. Please take special care under dry condition (e.g. Grounding of human body / equipment / solder iron, isolation from charged objects, setting of ionizer, friction prevention and temperature / humidity control).

Precaution for Storage / Transportation

1. Product performance and soldered connections may deteriorate if the Products are stored in the places where:
 - [a] the Products are exposed to sea winds or corrosive gases, including Cl₂, H₂S, NH₃, SO₂, and NO₂
 - [b] the temperature or humidity exceeds those recommended by ROHM
 - [c] the Products are exposed to direct sunshine or condensation
 - [d] the Products are exposed to high Electrostatic
2. Even under ROHM recommended storage condition, solderability of products out of recommended storage time period may be degraded. It is strongly recommended to confirm solderability before using Products of which storage time is exceeding the recommended storage time period.
3. Store / transport cartons in the correct direction, which is indicated on a carton with a symbol. Otherwise bent leads may occur due to excessive stress applied when dropping of a carton.
4. Use Products within the specified time after opening a humidity barrier bag. Baking is required before using Products of which storage time is exceeding the recommended storage time period.

Precaution for Product Label

QR code printed on ROHM Products label is for ROHM's internal use only.

Precaution for Disposition

When disposing Products please dispose them properly using an authorized industry waste company.

Precaution for Foreign Exchange and Foreign Trade act

Since our Products might fall under controlled goods prescribed by the applicable foreign exchange and foreign trade act, please consult with ROHM representative in case of export.

Precaution Regarding Intellectual Property Rights

1. All information and data including but not limited to application example contained in this document is for reference only. ROHM does not warrant that foregoing information or data will not infringe any intellectual property rights or any other rights of any third party regarding such information or data. ROHM shall not be in any way responsible or liable for infringement of any intellectual property rights or other damages arising from use of such information or data.:
2. No license, expressly or implied, is granted hereby under any intellectual property rights or other rights of ROHM or any third parties with respect to the information contained in this document.

Other Precaution



1. This document may not be reprinted or reproduced, in whole or in part, without prior written consent of ROHM.
2. The Products may not be disassembled, converted, modified, reproduced or otherwise changed without prior written consent of ROHM.
3. In no event shall you use in any way whatsoever the Products and the related technical information contained in the Products or this document for any military purposes, including but not limited to, the development of mass-destruction weapons.
4. The proper names of companies or products described in this document are trademarks or registered trademarks of ROHM, its affiliated companies or third parties.

General Precaution

1. Before you use our Products, you are requested to carefully read this document and fully understand its contents. ROHM shall not be in any way responsible or liable for failure, malfunction or accident arising from the use of any ROHM's Products against warning, caution or note contained in this document.
2. All information contained in this document is current as of the issuing date and subject to change without any prior notice. Before purchasing or using ROHM's Products, please confirm the latest information with a ROHM sales representative.
3. The information contained in this document is provided on an "as is" basis and ROHM does not warrant that all information contained in this document is accurate and/or error-free. ROHM shall not be in any way responsible or liable for any damages, expenses or losses incurred by you or third parties resulting from inaccuracy or errors of or concerning such information.

Looking for pricing, stock, or lifecycle information?

Click below to explore more details on WIN SOURCE:

-  [View BA3259HFP-TR](#) on WIN SOURCE
-  [Rohm Semiconductor](#) Information

Optimize Your Supply Chain with WIN SOURCE Solutions

-  Global Sourcing Solution
-  Obsolete Management
-  Cost Control Management
-  Shortage Management
-  Alternative Solution
-  Excess Inventory Management