



**THE DATASHEET OF
WR02X2201FAL**



APPROVAL SHEET

WR02X(W)

±5%, ±1%

Thick Film General purpose chip resistors

Size 0201

RoHS 2 Compliant with exemption 7C-1

Halogen free



*Contents in this sheet are subject to change without prior notice.

FEATURE

1. Small size and light weight
2. High reliability and stability
3. Reduced size of final equipment
4. Suitable for high density print circuit board assembly
5. Higher component and equipment reliability
6. RoHS 2 Compliant with exemption 7C-1 Halogen free

APPLICATION

- Mobile phone
- PDA
- Camcorders
- Palmtop computers
- Hybrid module

DESCRIPTION

The resistors are constructed in a high grade ceramic body (aluminum oxide). Internal metal electrodes are added at each end and connected by a resistive paste that is applied to the top surface of the substrate. The composition of the paste is adjusted to give the approximate resistance required and the value is trimmed to nominated value within tolerance which controlled by laser trimming of this resistive layer.

The resistive layer is covered with a protective coat. Finally, the two external end terminations are added. For ease of soldering the outer layer of these end terminations is a pure Tin.

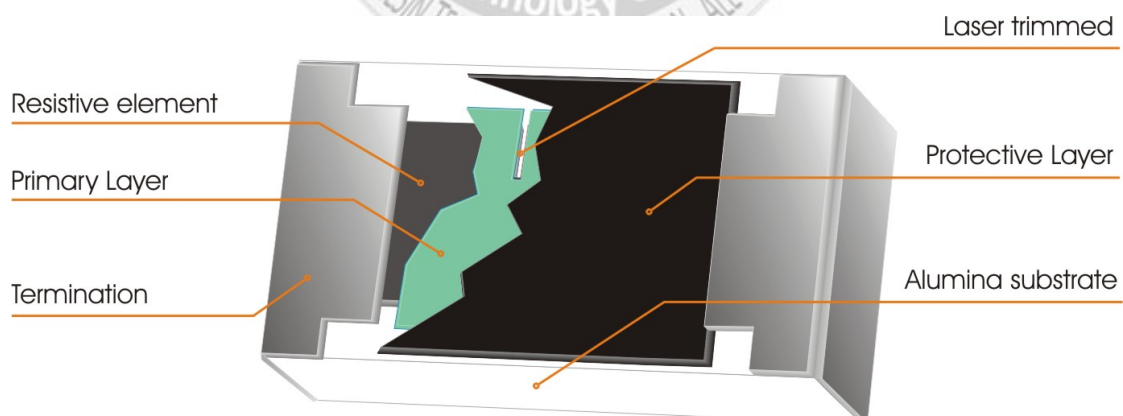

Fig 1. Construction of Chip-R WR02X

QUICK REFERENCE DATA

Item	General Specification	
Series No.	WR02X(W)	
Size code	0201(0603)	
Resistance Range	1Ω~10MΩ (±5% tolerance), Jumper 1Ω~ 10MΩ (±1% tolerance)	
Resistance Tolerance	±1% E96/E24	±5% E24
TCR (ppm/°C)	10Ω - 10MΩ, ≤±200 1 - 9.76Ω, +600~-200	
Max. dissipation @ T _{amb} =70°C	1/20 W	
Max. Operation Voltage (DC or RMS)	25V	
Max. Overload Voltage (DC or RMS)	50V	
Operation temperature	-55 ~ +155°C	

Note :

1. This is the maximum voltage that may be continuously supplied to the resistor element, see "IEC publication 60115-8"
2. Max. Operation Voltage : So called RCWV (Rated Continuous Working Voltage) is determined by

$$RCWV = \sqrt{\text{Rated Power} \times \text{Resistance Value}} \text{ or Max. RCWV listed above, whichever is lower.}$$

DIMENSION(unit : mm)

	WR02X(W)
L	0.60 ± 0.03
W	0.30 ± 0.03
T	0.23 ± 0.03
Tb	0.15 ± 0.05
Tt	0.10 ± 0.05



MARKING

WR02X(W) has no marking.

FUNCTIONAL DESCRIPTION

Product characterization

Standard values of nominal resistance are taken from the E24/E96 series for resistors with a tolerance of $\pm 5\%$ & $\pm 1\%$. The values of the E24/E96 series are in accordance with "IEC publication 60063"

Derating

The power that the resistor can dissipate depends on the operating temperature; see Fig.2

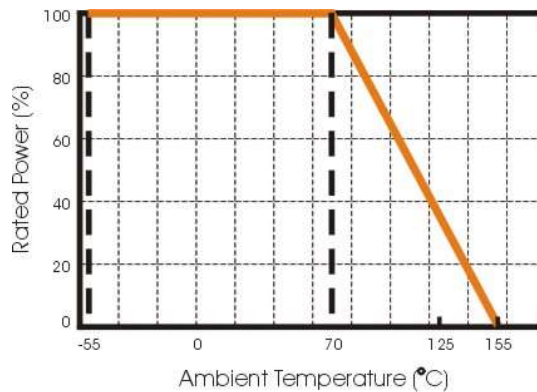

Figure 2. Maximum dissipation in percentage of rated power
As a function of the ambient temperature

MOUNTING

Due to their rectangular shapes and small tolerances, Surface Mountable Resistors are suitable for handling by automatic placement systems.

Chip placement can be on ceramic substrates and printed-circuit boards (PCBs).

Electrical connection to the circuit is by individual soldering condition.

The end terminations guarantee a reliable contact.

SOLDERING CONDITION

The robust construction of chip resistors allows them to be completely immersed in a solder bath of 260°C for 10 seconds. Therefore, it is possible to mount Surface Mount Resistors on one side of a PCB and other discrete components on the reverse (mixed PCBs).

Surface Mount Resistors are tested for solderability at 235°C during 2 seconds. The test condition for no leaching is 260°C for 30 seconds. Typical examples of soldering processes that provide reliable joints without any damage are given in Fig 3.

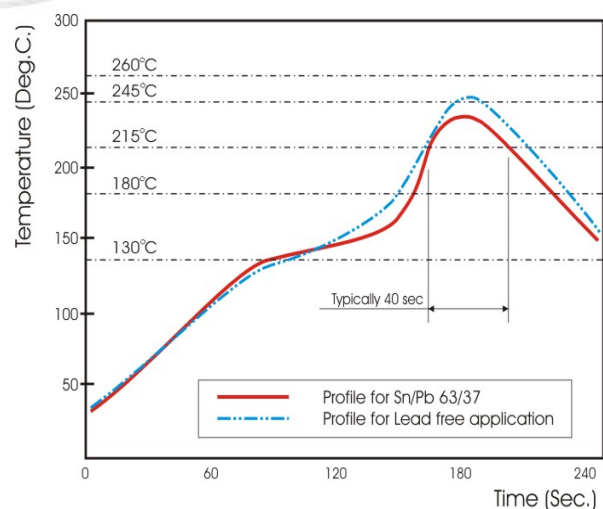

Fig 3. Infrared soldering profile for Chip Resistors WR02X(W)

CATALOGUE NUMBERS

The resistors have a catalogue number starting with :

WR02	X	472_	J	A	L
Size code WR02 : 0201	Type code X : Normal W : 1% For <10Ω and >1MΩ	Resistance code 5%, E24: 2 significant digits followed by no. of zeros and a blank 4.7Ω = 4R7_ 100Ω = 101_ 10KΩ = 103_ 1%, E24+E96: 3 significant digits followed by no. of zeros 100Ω =1000 37.4KΩ =3742	Tolerance J : ±5% F : ±1% P : Jumper	Packaging code A : 7" Reeled taping (15Kpcs/Reel) T : 7" Reeled taping (10Kpcs/Reel) D : 7" Reeled taping (20Kpcs/Reel) H : 13" Reeled taping (50Kpcs/Reel) G : 13" Reeled taping (70Kpcs/Reel)	Termination code L = Sn base (lead free)

TEST CONDITION FOR JUMPER (0 Ω)

Item	WR02
Power Rating At 70°C	1/20W
Resistance	MAX.50mΩ
Rated Current	1A
Peak Current within 5 sec	2.5A
Operating Temperature	-55 ~ +155°C

TEST AND REQUIREMENTS (JIS C 5201-1 : 1998)

TEST	PROCEDURE / TEST METHOD	REQUIREMENT	
		Resistor	0Ω
Electrical Characteristics JISC5201-1: 1998 Clause 4.8	- DC resistance values measurement - Temperature Coefficient of Resistance (T.C.R) Natural resistance change per change in degree centigrade. $\frac{R_2 - R_1}{R_1(t_2 - t_1)} \times 10^6 \text{ (ppm/}^\circ\text{C)} \quad t_1 : 20^\circ\text{C}+5^\circ\text{C}-1^\circ\text{C}$ R_1 : Resistance at reference temperature (20°C+5°C/-1°C) R_2 : Resistance at test temperature (-55°C or +155°C)	Within the specified tolerance Refer to "QUICK REFERENCE DATA"	<50mΩ
Short time overload (S.T.O.L) Clause 4.13	Permanent resistance change after a 5second application of a voltage 2.5 times RCWV or the maximum overload voltage specified in the above list, whichever is less.	ΔR/R max. ±(2%+0.10Ω)	<50mΩ
Resistance to soldering heat(R.S.H) Clause 4.18	Un-mounted chips completely immersed for 10±1second in a SAC solder bath at 260°C±5°C	Δ R/R max. ±(1%+0.05Ω) no visible damage	<50mΩ
Solderability Clause 4.17	Un-mounted chips completely immersed for 2±0.8second in a SAC solder bath at 235°C±5°C	95% coverage min., good tinning and no visible damage	
Temperature cycling Clause 4.19	30 minutes at -55°C±3°C, 2~3 minutes at 20°C+5°C-1°C, 30 minutes at +155°C±3°C, 2~3 minutes at 20°C+5°C-1°C, total 5 continuous cycles	ΔR≤ ±(0.5%+0.05Ω)	< 50mΩ
Damp Heat (Load life in humidity) Clause 4.24	1000 +48/-0 hours, loaded with RCWV or Vmax in humidity chamber controller at 40°C±2°C and 90~95% relative humidity, 1.5hours on and 0.5 hours off	10Ω≤R<1MΩ : ΔR/R max. ±(3%+0.10Ω) R<10Ω, R≥1MΩ : ΔR/R max. ±(5%+0.10Ω)	< 50mΩ
Load Life (Endurance) Clause 4.25	1000+48/-0 hours; loaded with RCWV or Vmax in chamber controller 70±2°C, 1.5 hours on and 0.5 hours off	Ditto.	
Bending strength Clause 4.33	Resistors mounted on a 90mm glass epoxy resin PCB(FR4), bending once 5mm for 10sec.	No visual damaged, ΔR/R max. ±(1%+0.05Ω)	< 50mΩ
Adhesion Clause 4.32	Pressurizing force: 3N, Test time: 10±1sec.	No remarkable damage or removal of the terminations	
High Temperature Exposure clause 4.25.3	Ambient temperature:155 °C ± 2 °C Duration: 1000 hours Examination at 48 hours, 500 hours and 1000 hours: Visual examination Resistance	No visible damage, ΔR ≤ ± (2%+0.1Ω)	< 50mΩ

PACKAGING

Paper Tape specifications (unit :mm)



Series No.	A	B	W	F	E
WR02X	0.67±0.05	0.37±0.05	8.00±0.20	3.50±0.05	1.75±0.10

Series No.	P1	P0	P2	ΦD	T
WR02X	2.00±0.05	4.00±0.05	2.00±0.05	Φ1.50 ^{+0.1} _{-0.0}	0.45±0.05

Reel dimensions

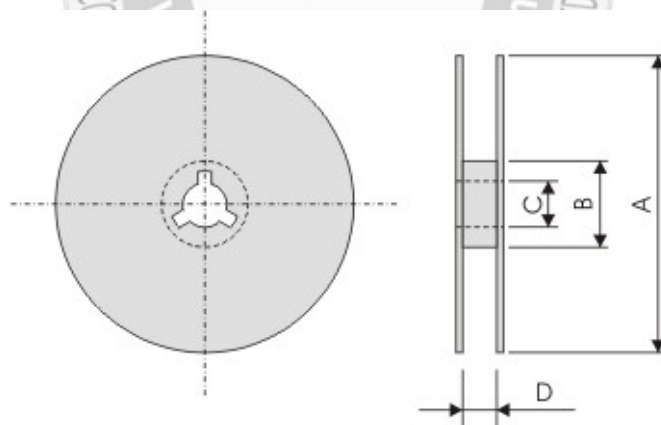

Symbol	A	B	C	D
7" Reel	Φ178.0±0.2	Φ60.0±1.0	13.0±0.2	9.0±0.5

Taping quantity and Tape material

- Chip resistors 10,000 / 15,000 pcs 7" Reel, Paper tape.

Looking for pricing, stock, or lifecycle information?

Click below to explore more details on WIN SOURCE:

- ⊖ [View WR02X2201FAL on WIN SOURCE](#)
- ⊖ [Walsin Technology Corporation Information](#)

Optimize Your Supply Chain with WIN SOURCE Solutions

- ✓ Global Sourcing Solution
- ✓ Obsolete Management
- ✓ Cost Control Management
- ✓ Shortage Management
- ✓ Alternative Solution
- ✓ Excess Inventory Management