



**THE DATASHEET OF  
BA4560N**



# Dual high slew rate operational amplifier

## BA4560 / BA4560F / BA4560N

The BA4560, BA4560F, and BA4560N are dual operational amplifiers which achieve approximately twice the high output current of the BA4558, as well as featuring a higher slew rate of  $4V / \mu s$ , a gain band width of 10MHz, and an improved frequency characteristic. The following packages are available: 8-pin DIP (BA4560), 8-pin SOP (BA4560F), and 8-pin SIP (BA4560N).

●Applications

- Active filters
- Audio amplifiers
- VCOs
- Other electronic circuits

●Features

- 1) Built-in output short-circuit protection circuit.
- 2) Internal phase correction.
- 3) No latch-up.
- 4) Wide range of common-mode modes and differential voltage.
- 5) High gain and low noise.

●Block diagram

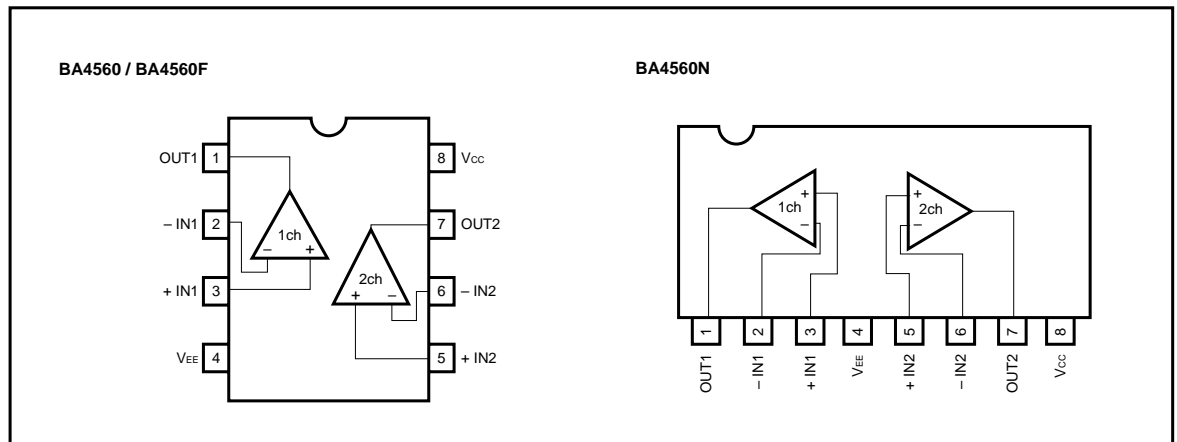

●Internal circuit configuration

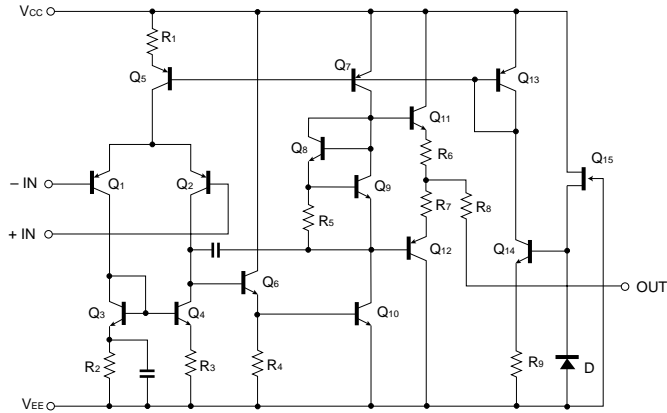

●Absolute maximum ratings (Ta = 25°C)

Parameter	Symbol	Limits			Unit
		BA4560	BA4560F	BA4560N	
Power supply voltage	V <sub>CC</sub>	± 18	± 18	± 18	V
Power dissipation	P <sub>d</sub>	800*	550*	900*	mW
Differential input voltage	V <sub>ID</sub>	± V <sub>CC</sub>			V
Common-mode input voltage	V <sub>I</sub>	- V <sub>CC</sub> ~ V <sub>CC</sub>			V
Operating temperature	T <sub>opr</sub>	- 40 ~ + 85			°C
Storage temperature	T <sub>stg</sub>	- 55 ~ + 125			°C

\* Refer to the P<sub>d</sub> characteristics diagram. The values for the BA4560F are those when it is mounted on a glass epoxy PCB (50mm × 50mm × 1.6mm).

●Electrical characteristics (unless otherwise noted, Ta = 25°C, V<sub>CC</sub> = +15 V, V<sub>EE</sub> = -15 V)

Parameter	Symbol	Min.	Typ.	Max.	Unit	Conditions
Input offset voltage	V <sub>IO</sub>	—	0.5	6.0	mV	R <sub>S</sub> ≤ 10kΩ
Input offset current	I <sub>IO</sub>	—	5	200	nA	
Input bias current	I <sub>B</sub>	—	50	500	nA	
High-amplitude voltage gain	A <sub>v</sub>	86	100	—	dB	R <sub>L</sub> ≥ 2kΩ, V <sub>o</sub> = ± 10V
Common-mode input voltage	V <sub>ICM</sub>	± 12	± 14	—	V	
Maximum output voltage 1	V <sub>OM1</sub>	± 12	± 14	—	V	R <sub>L</sub> ≥ 10kΩ
Maximum output voltage 2	V <sub>OM2</sub>	± 10	± 13	—	V	R <sub>L</sub> ≥ 2kΩ
Common-mode rejection ratio	CMRR	70	90	—	dB	R <sub>S</sub> ≤ 10kΩ
Power supply voltage rejection ratio	PSRR	—	30	150	μV / V	R <sub>S</sub> ≤ 10kΩ
Slew rate	S. R.	—	4.0	—	V / μs	A <sub>v</sub> = 1, R <sub>L</sub> = 2kΩ
Input conversion noise voltage	V <sub>n</sub>	—	—	2.2	μV	
Gain band width product	GBW	—	10	—	MHz	f = 10kHz

●Electrical characteristic curves

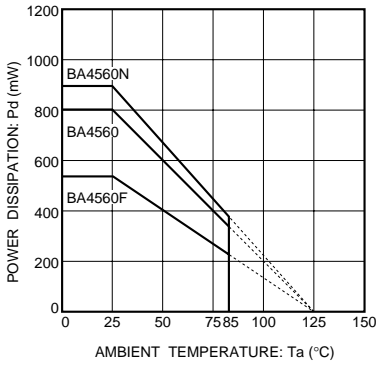

Fig.1 Power dissipation vs. ambient temperature

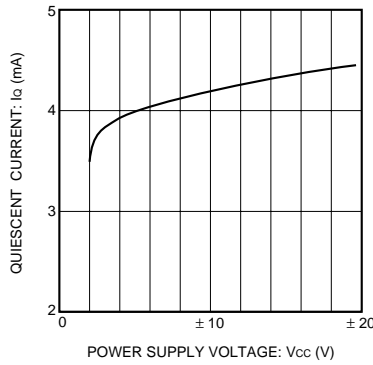

Fig.2 Quiescent current vs. power supply voltage

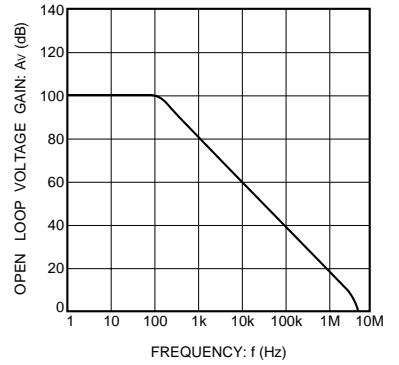

Fig.3 Open loop voltage gain vs. frequency

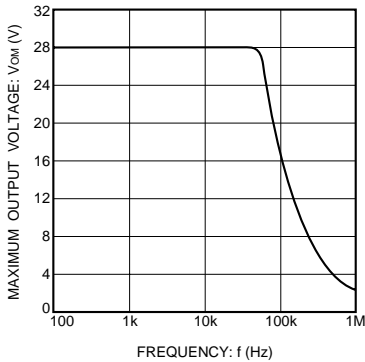

Fig.4 Maximum output voltage vs. frequency

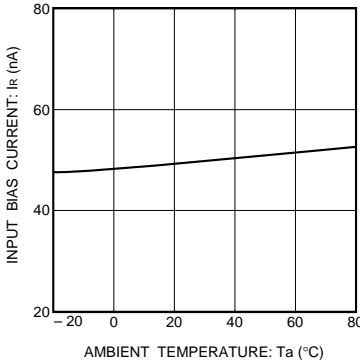

Fig.5 Input bias current vs. ambient temperature

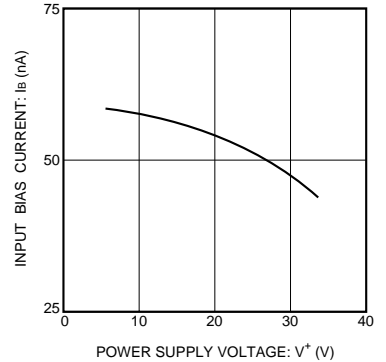

Fig.6 Input bias current vs. power supply voltage

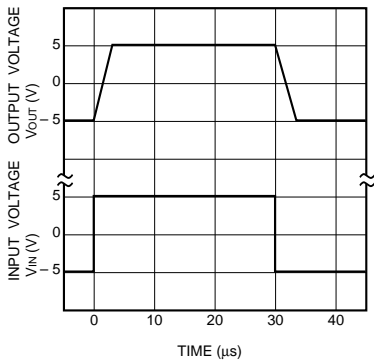

Fig.7 Output response characteristics

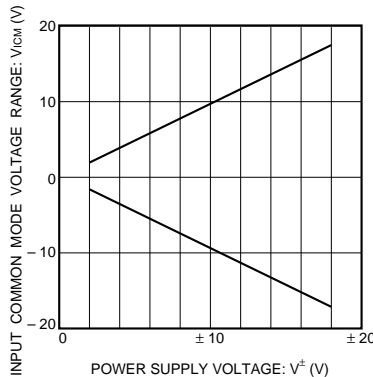

Fig.8 Common mode input voltage vs. power supply voltage

●Operation notes

(1) Handling unused circuits

If there are any circuits which are not being used, we recommend making connections as shown in Figure 9, with the non-inverted input pin connected to the potential within the in-phase input voltage range ( $V_{ICM}$ ).

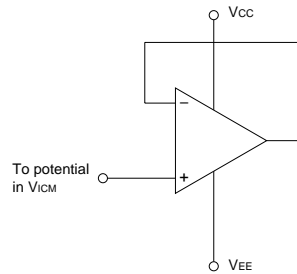
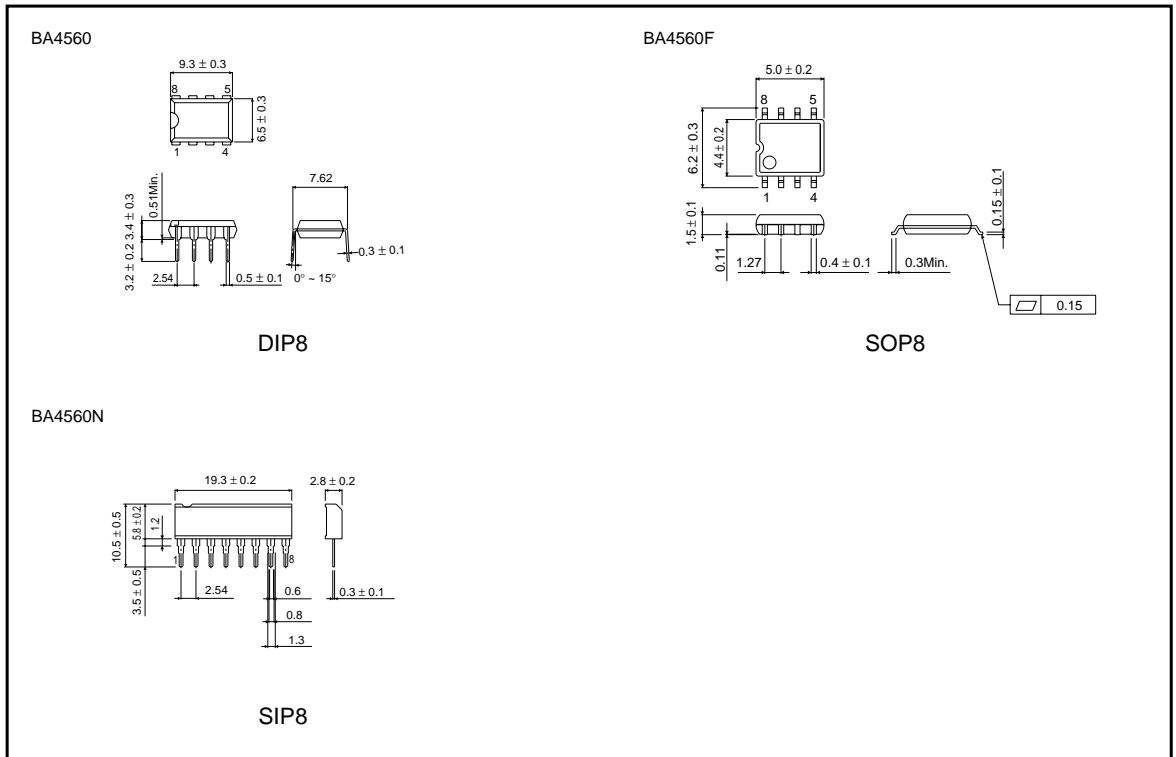



Fig.9 Unused circuit connections

●Exteral dimensions (Units: mm)



## Looking for pricing, stock, or lifecycle information?

Click below to explore more details on WIN SOURCE:

-  [View BA4560N on WIN SOURCE](#)
-  [Rohm Semiconductor Information](#)

## Optimize Your Supply Chain with WIN SOURCE Solutions

-  Global Sourcing Solution
-  Obsolete Management
-  Cost Control Management
-  Shortage Management
-  Alternative Solution
-  Excess Inventory Management