



**THE DATASHEET OF
BCX5616QTA**



Description

This Bipolar Junction Transistor (BJT) is designed to meet the stringent requirements of Automotive Applications.

Features

- $BV_{CE0} > 80V$
- $I_C = 1A$ High Continuous Collector Current
- $I_{CM} = 2.0A$ Peak Pulse Current
- Low Saturation Voltage $V_{CE(sat)} < 500mV @ 0.5A$
- Epitaxial Planar Die Construction
- Complementary PNP types: BCX5316Q
- **Totally Lead-Free & Fully RoHS Compliant (Notes 1 & 2)**
- **Halogen- and Antimony-Free. "Green" Device (Note 3)**
- **The BCX5616Q is suitable for automotive applications requiring specific change control; this part is AEC-Q101 qualified, PPAP capable, and manufactured in IATF16949 certified facilities.**

<https://www.diodes.com/quality/product-definitions/>

Mechanical Data

- Case: SOT89
- Case Material: Molded Plastic, "Green" Molding Compound
UL Flammability Rating 94V-0
- Moisture Sensitivity: Level 1 per J-STD-020
- Terminals: Matte Tin Finish Leads,
Solderable per MIL-STD-202 Method 208 Ⓜ3
- Weight: 0.055 grams (Approximate)

Applications

- Automotive
- Medium Power Switching or Amplification Applications
- AF Driver and Output Stages



Top View

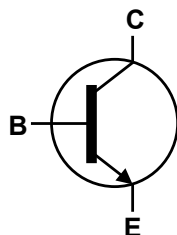

Device Symbol

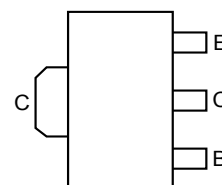

Top View
Pin-Out

Ordering Information (Note 4)

Product	Compliance	Marking	Reel size (inches)	Tape width (mm)	Quantity per reel
BCX5616QTA	Automotive	BL	7	12	1,000
BCX5616QTC	Automotive	BL	13	12	4,000

- Notes:
1. No purposely added lead. Fully EU Directive 2002/95/EC (RoHS), 2011/65/EU (RoHS 2) & 2015/863/EU (RoHS 3) compliant.
 2. See <https://www.diodes.com/quality/lead-free/> for more information about Diodes Incorporated's definitions of Halogen- and Antimony-free, "Green" and Lead-free.
 3. Halogen- and Antimony-free "Green" products are defined as those which contain <900ppm bromine, <900ppm chlorine (<1500ppm total Br + Cl) and <1000ppm antimony compounds.
 4. For packaging details, go to our website at <https://www.diodes.com/design/support/packaging/diodes-packaging/>.

Marking Information

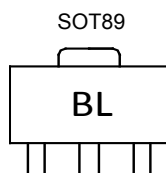

BL = Product Type Marking Code

Absolute Maximum Ratings (@ $T_A = +25^\circ\text{C}$, unless otherwise specified.)

Characteristic	Symbol	Value	Unit
Collector-Base Voltage	V_{CBO}	100	V
Collector-Emitter Voltage	V_{CEO}	80	V
Emitter-Base Voltage	V_{EBO}	6	V
Continuous Collector Current	I_C	1	A
Peak Pulse Collector Current	I_{CM}	2.0	
Continuous Base Current	I_B	100	mA
Peak Pulse Base Current	I_{BM}	200	

Thermal Characteristics (@ $T_A = +25^\circ\text{C}$, unless otherwise specified.)

Characteristic	Symbol	Value	Unit
Power Dissipation	P_D	(Note 5)	1
		(Note 6)	1.5
		(Note 7)	2.0
Thermal Resistance, Junction to Ambient Air	$R_{\theta JA}$	(Note 5)	125
		(Note 6)	83
		(Note 7)	60
Thermal Resistance, Junction to Lead	$R_{\theta JL}$	13	$^\circ\text{C/W}$
Operating and Storage Temperature Range	T_J, T_{STG}	-55 to +150	$^\circ\text{C}$

ESD Ratings (Note 9)

Characteristic	Symbol	Value	Unit	JEDEC Class
Electrostatic Discharge - Human Body Model	ESD HBM	4,000	V	3A
Electrostatic Discharge - Machine Model	ESD MM	400	V	C

- Notes:
- For a device mounted with the exposed collector pad on 15mm x 15mm 1oz copper that is on a single-sided 1.6mm FR4 PCB; device is measured under still air conditions whilst operating in a steady-state.
 - Same as note (6), except the device is mounted on 25mm x 25mm 1oz copper.
 - Same as note (6), except the device is mounted on 50mm x 50mm 1oz copper.
 - Thermal resistance from junction to solder-point (on the exposed collector pad).
 - Refer to JEDEC specification JESD22-A114 and JESD22-A115.

Thermal Characteristics and Derating Information

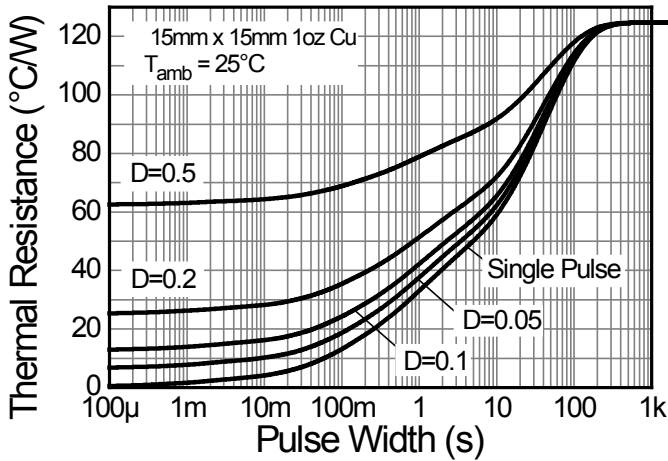

Transient Thermal Impedance

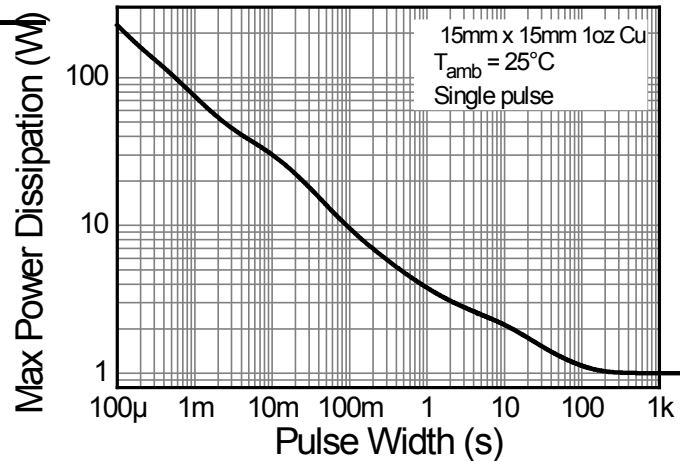

Pulse Power Dissipation

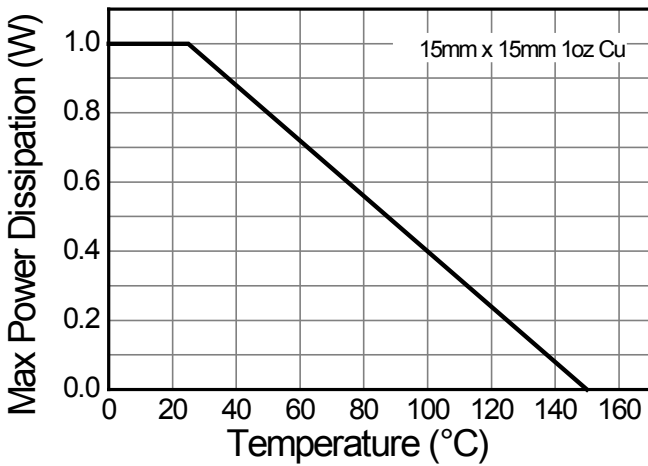

Derating Curve

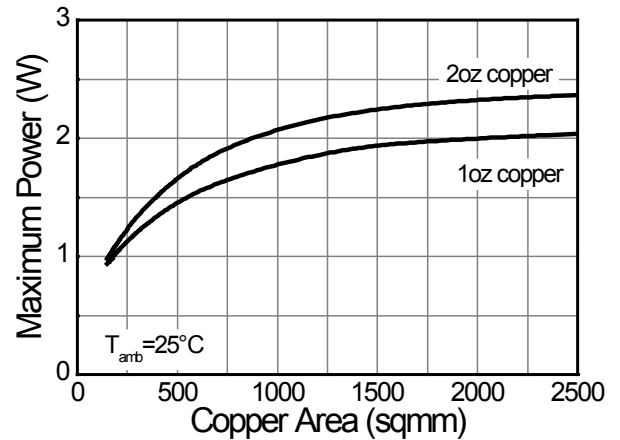
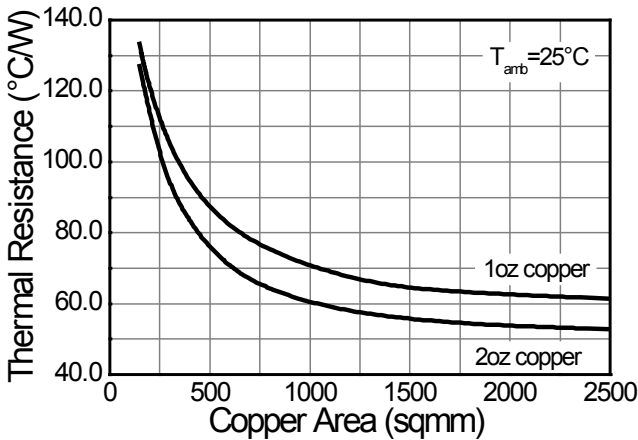

Electrical Characteristics (@ $T_A = +25^\circ\text{C}$, unless otherwise specified.)

Characteristic	Symbol	Min	Typ	Max	Unit	Test Condition
Collector-Base Breakdown Voltage	BV_{CBO}	100	—	—	V	$I_C = 100\mu\text{A}$
Collector-Emitter Breakdown Voltage (Note 10)	BV_{CEO}	80	—	—	V	$I_C = 10\text{mA}$
Emitter-Base Breakdown Voltage	BV_{EBO}	6	—	—	V	$I_E = 100\mu\text{A}$
Collector Cut-off Current	I_{CBO}	—	—	0.1 20	μA	$V_{CB} = 30\text{V}$ $V_{CB} = 30\text{V}, T_A = +150^\circ\text{C}$
Emitter Cut-off Current	I_{EBO}	—	—	20	nA	$V_{EB} = 5\text{V}$
Static Forward Current Transfer Ratio (Note 10)	h_{FE}	25 100 25	— — —	— 250 —	—	$I_C = 5\text{mA}, V_{CE} = 2\text{V}$ $I_C = 150\text{mA}, V_{CE} = 2\text{V}$ $I_C = 500\text{mA}, V_{CE} = 2\text{V}$
Collector-Emitter Saturation Voltage (Note 10)	$V_{CE(sat)}$	—	—	0.5	V	$I_C = 500\text{mA}, I_B = 50\text{mA}$
Base-Emitter Turn-On Voltage (Note 10)	$V_{BE(on)}$	—	—	1.0	V	$I_C = 500\text{mA}, V_{CE} = 2\text{V}$
Transition Frequency	f_T	150	—	—	MHz	$I_C = 50\text{mA}, V_{CE} = 10\text{V}$ $f = 100\text{MHz}$
Output Capacitance	C_{obo}	—	—	25	pF	$V_{CB} = 10\text{V}, f = 1\text{MHz}$

Notes: 10. Measured under pulsed conditions. Pulse width $\leq 300\mu\text{s}$. Duty cycle $\leq 2\%$.

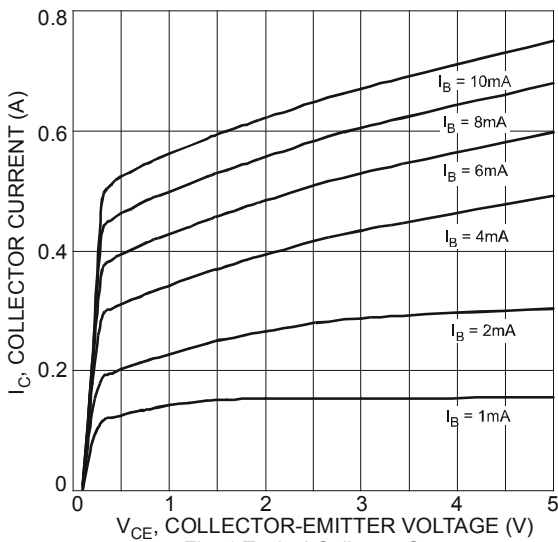

Fig. 1 Typical Collector Current vs. Collector-Emitter Voltage

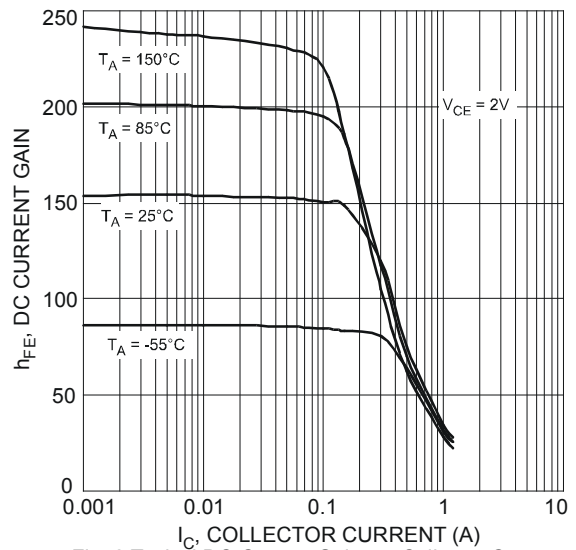

Fig. 2 Typical DC Current Gain vs. Collector Current

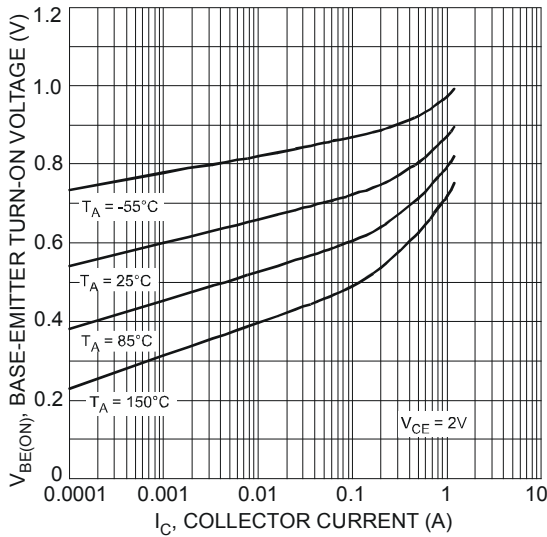

Fig. 3 Typical Base-Emitter Turn-On Voltage vs. Collector Current

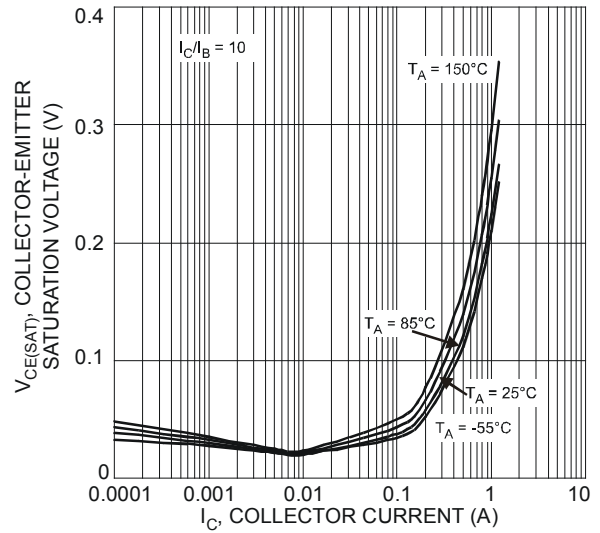

Fig. 4 Typical Collector-Emitter Saturation Voltage vs. Collector Current

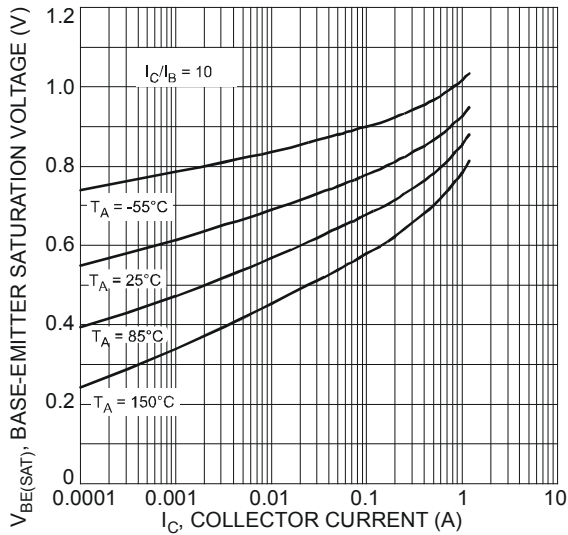

Fig. 5 Typical Base-Emitter Saturation Voltage vs. Collector Current

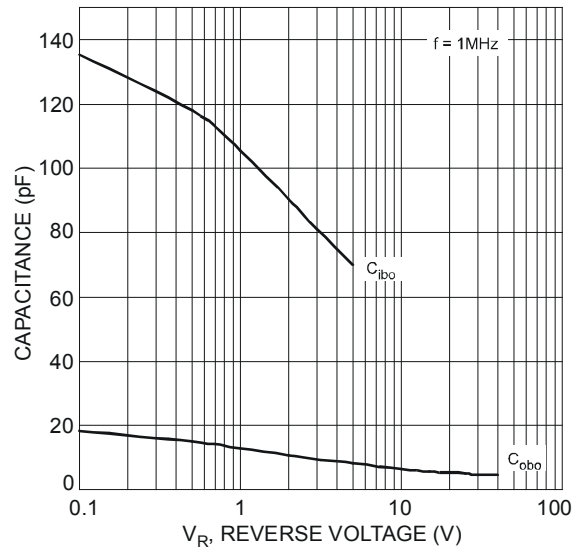

Fig. 6 Typical Capacitance Characteristics

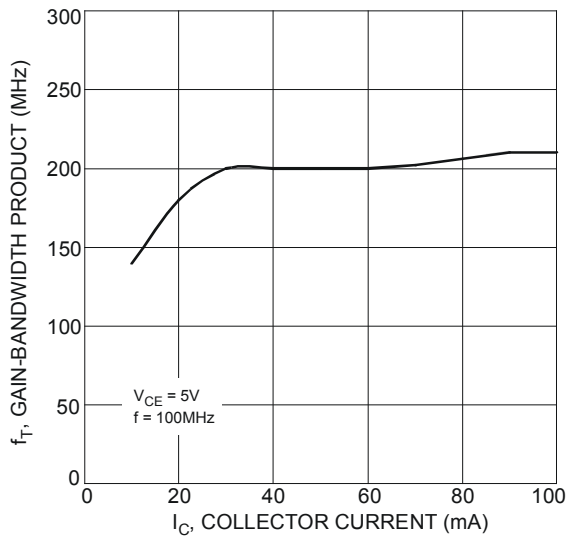
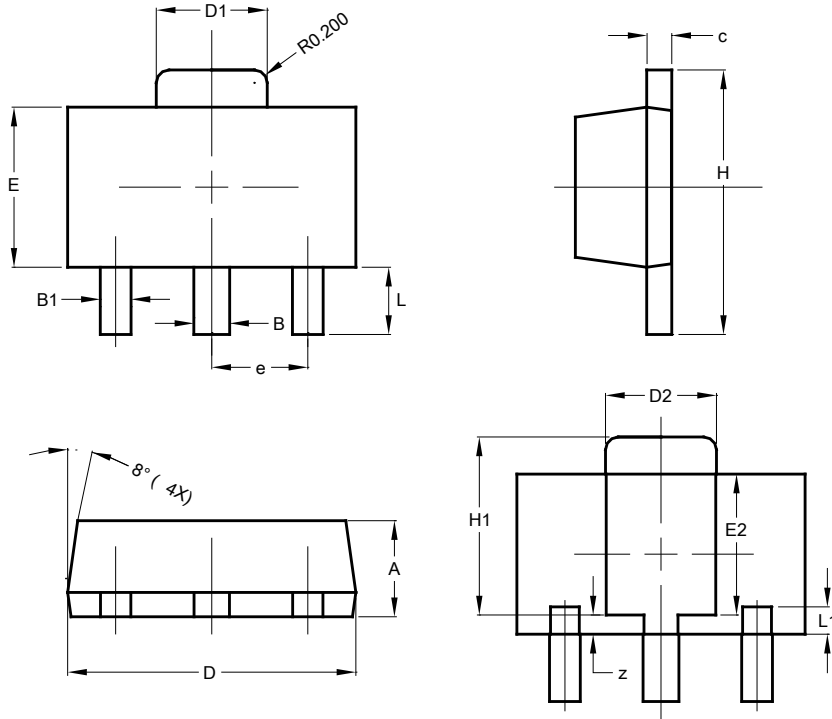

Fig. 7 Typical Gain-Bandwidth Product vs. Collector Current

Package Outline Dimensions

Please see <http://www.diodes.com/package-outlines.html> for the latest version.



SOT89			
Dim	Min	Max	Typ
A	1.40	1.60	1.50
B	0.50	0.62	0.56
B1	0.42	0.54	0.48
c	0.35	0.43	0.38
D	4.40	4.60	4.50
D1	1.62	1.83	1.733
D2	1.61	1.81	1.71
E	2.40	2.60	2.50
E2	2.05	2.35	2.20
e	-	-	1.50
H	3.95	4.25	4.10
H1	2.63	2.93	2.78
L	0.90	1.20	1.05
L1	0.327	0.527	0.427
z	0.20	0.40	0.30
All Dimensions in mm			

Suggested Pad Layout

Please see <http://www.diodes.com/package-outlines.html> for the latest version.

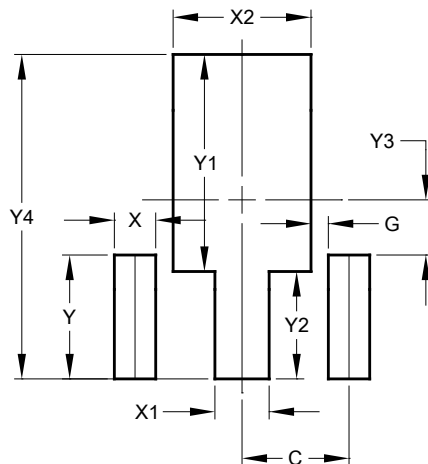

Dimensions	Value (in mm)
C	1.500
G	0.244
X	0.580
X1	0.760
X2	1.933
Y	1.730
Y1	3.030
Y2	1.500
Y3	0.770
Y4	4.530

IMPORTANT NOTICE

DIODES INCORPORATED MAKES NO WARRANTY OF ANY KIND, EXPRESS OR IMPLIED, WITH REGARDS TO THIS DOCUMENT, INCLUDING, BUT NOT LIMITED TO, THE IMPLIED WARRANTIES OF MERCHANTABILITY AND FITNESS FOR A PARTICULAR PURPOSE (AND THEIR EQUIVALENTS UNDER THE LAWS OF ANY JURISDICTION).

Diodes Incorporated and its subsidiaries reserve the right to make modifications, enhancements, improvements, corrections or other changes without further notice to this document and any product described herein. Diodes Incorporated does not assume any liability arising out of the application or use of this document or any product described herein; neither does Diodes Incorporated convey any license under its patent or trademark rights, nor the rights of others. Any Customer or user of this document or products described herein in such applications shall assume all risks of such use and will agree to hold Diodes Incorporated and all the companies whose products are represented on Diodes Incorporated website, harmless against all damages.

Diodes Incorporated does not warrant or accept any liability whatsoever in respect of any products purchased through unauthorized sales channel. Should Customers purchase or use Diodes Incorporated products for any unintended or unauthorized application, Customers shall indemnify and hold Diodes Incorporated and its representatives harmless against all claims, damages, expenses, and attorney fees arising out of, directly or indirectly, any claim of personal injury or death associated with such unintended or unauthorized application.

Products described herein may be covered by one or more United States, international or foreign patents pending. Product names and markings noted herein may also be covered by one or more United States, international or foreign trademarks.

This document is written in English but may be translated into multiple languages for reference. Only the English version of this document is the final and determinative format released by Diodes Incorporated.

LIFE SUPPORT

Diodes Incorporated products are specifically not authorized for use as critical components in life support devices or systems without the express written approval of the Chief Executive Officer of Diodes Incorporated. As used herein:

A. Life support devices or systems are devices or systems which:

1. are intended to implant into the body, or
2. support or sustain life and whose failure to perform when properly used in accordance with instructions for use provided in the labeling can be reasonably expected to result in significant injury to the user.

B. A critical component is any component in a life support device or system whose failure to perform can be reasonably expected to cause the failure of the life support device or to affect its safety or effectiveness.

Customers represent that they have all necessary expertise in the safety and regulatory ramifications of their life support devices or systems, and acknowledge and agree that they are solely responsible for all legal, regulatory and safety-related requirements concerning their products and any use of Diodes Incorporated products in such safety-critical, life support devices or systems, notwithstanding any devices- or systems-related information or support that may be provided by Diodes Incorporated. Further, Customers must fully indemnify Diodes Incorporated and its representatives against any damages arising out of the use of Diodes Incorporated products in such safety-critical, life support devices or systems.

Copyright © 2020, Diodes Incorporated

www.diodes.com

Looking for pricing, stock, or lifecycle information?

Click below to explore more details on WIN SOURCE:

 [View BCX5616QTA on WIN SOURCE](#)

 [Diodes Incorporated Information](#)

Optimize Your Supply Chain with WIN SOURCE Solutions

-  Global Sourcing Solution
-  Obsolete Management
-  Cost Control Management
-  Shortage Management
-  Alternative Solution
-  Excess Inventory Management