

Description

The AP3428/A is a 1A step-down DC-DC converter. At heavy load, the constant-frequency PWM control performs excellent stability and transient response. No external compensation components are required.

The AP3428/A supports a range of input voltages from 2.5V to 5.5V, allowing the use of a single Li+/Li-polymer cell, multiple Alkaline/NiMH cell, and other standard power sources. The output voltage is adjustable from 0.6V to the input voltage. The AP3428/A employs internal power switch and synchronous rectifier to minimize external part count and realize high efficiency. During shutdown, the input is disconnected from the output and the shutdown current is less than 1 μ A. Other key features include over-temperature and short circuit protection, and under-voltage lockout to prevent deep battery discharge.

The AP3428/A delivers 1A maximum output current while consuming only 40 μ A of no-load quiescent current. Ultra-low $R_{DS(ON)}$ integrated MOSFETs and 100% duty cycle operation make the AP3428/A an ideal choice for high output voltage, high current applications which require a low dropout threshold. Pulse skip mode allows to maintain high efficiency at light-load conditions.

The AP3428/A is available in TSOT25, TSOT25 (Type SM), U-DFN2020-6 (Type J) packages.

Features

- Output Current: Up to 1A
- Output Voltage: 0.6V to V_{IN}
- Input Voltage: 2.5V to 5.5V
- 0.6V Reference Voltage with $\pm 2\%$ Precision
- 40 μ A (typ) No Load Quiescent Current
- Shutdown Current: <1 μ A
- 100% Duty Cycle Operation
- 1.5MHz Switching Frequency
- Internal Soft Start
- No External Compensation Required
- Current Limit Protection
- Thermal Shutdown
- TSOT25, TSOT25 (Type SM), U-DFN2020-6 (Type J) Packages
- **Totally Lead-Free & Fully RoHS Compliant (Notes 1 & 2)**
- **Halogen and Antimony Free. "Green" Device (Note 3)**
- **For automotive applications requiring specific change control (i.e. parts qualified to AEC-Q100/101/200, PPAP capable, and manufactured in IATF 16949 certified facilities), please [contact us](mailto:contact@diodes.com) or your local Diodes representative. <https://www.diodes.com/quality/product-definitions/>**

Notes: 1. No purposely added lead. Fully EU Directive 2002/95/EC (RoHS), 2011/65/EU (RoHS 2) & 2015/863/EU (RoHS 3) compliant.
 2. See <https://www.diodes.com/quality/lead-free/> for more information about Diodes Incorporated's definitions of Halogen- and Antimony-free, "Green" and Lead-free.
 3. Halogen- and Antimony-free "Green" products are defined as those which contain <900ppm bromine, <900ppm chlorine (<1500ppm total Br + Cl) and <1000ppm antimony compounds.

Pin Assignments

(Top View)

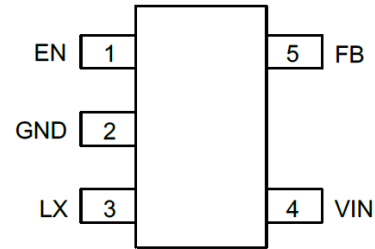

TSOT25/TSOT25 (Type SM) for AP3428

(Top View)

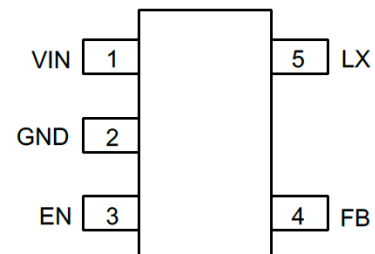

TSOT25/TSOT25 (Type SM) for AP3428A

(Top View)

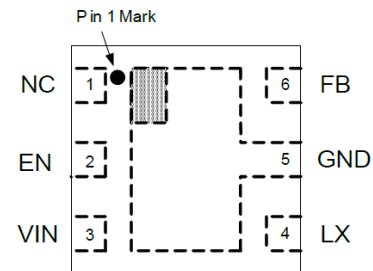

U-DFN2020-6 (Type J)

Applications

- Post DC-DC Voltage Regulation
- Set Top Boxes
- Notebook Computer
- PAD

Typical Applications Circuit

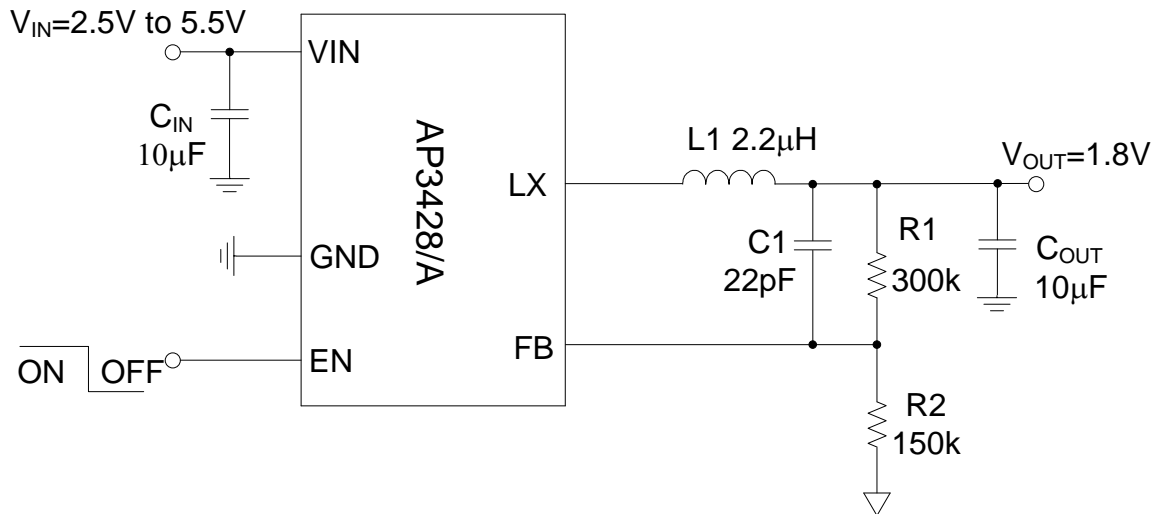

Pin Descriptions

| Pin Number | | | Pin Name | Function |
|---|--|-------------------------|----------|---|
| TSOT25/ TSOT25 (Type SM) for AP3428 | TSOT25/ TSOT25 (Type SM) for AP3428A | U-DFN2020-6 (Type J) | | |
| 1 | 3 | 2 | EN | Enable control input. Force this pin voltage above 1.5V enables the chip, and below 0.4V shuts down the device. |
| 2 | 2 | 5 | GND | Ground pin |
| 3 | 5 | 4 | LX | The drains of the internal main and synchronous power MOSFET. |
| 4 | 1 | 3 | VIN | Bias supply. Chip main power supply pin |
| 5 | 4 | 6 | FB | Feedback voltage to internal error amplifier, the threshold voltage is 0.6V. |
| — | — | 1 | NC | NC |

Absolute Maximum Ratings (Note 4)

| Symbol | Parameter | Rating | Unit | |
|---------------|--|----------------------------|------------------|---------------------------|
| V_{IN} | Input Voltage | -0.3 to 6 | V | |
| V_{EN} | EN Pin Voltage | -0.3 to $V_{IN}+0.3$ | V | |
| V_{LX} | LX Pin Voltage | -0.3 to $V_{IN}+0.3$ | V | |
| | | -3V to 7V (<40ns) | V | |
| V_{FB} | Feedback Pin Voltage | -0.3 to $V_{IN}+0.3$ | V | |
| P_D | Power Dissipation (on PCB, $T_A = +25^\circ\text{C}$) | TSOT25 TSOT25 (Type SM) | 0.4 | W |
| | | U-DFN2020-6 (Type J) | 1.89 | |
| θ_{JA} | Thermal Resistance (Junction to Ambient) | TSOT25 TSOT25 (Type SM) | 220 | $^\circ\text{C}/\text{W}$ |
| | | U-DFN2020-6 (Type J) | 53 | |
| θ_{JC} | Thermal Resistance (Junction to Case, Simulation) | TSOT25 TSOT25 (Type SM) | 130 | $^\circ\text{C}/\text{W}$ |
| | | U-DFN2020-6 (Type J) | 25 | |
| T_J | Operating Junction Temperature | +155 | $^\circ\text{C}$ | |
| T_{STG} | Storage Temperature | -55 to +150 | $^\circ\text{C}$ | |
| V_{MM} | ESD (Machine Model) | 200 | V | |
| V_{HBM} | ESD (Human Body Model) | 2000 | V | |
| V_{CDM} | ESD (Charge Device Mode) | 1000 | V | |

Note 4: Stresses greater than those listed under *Absolute Maximum Ratings* can cause permanent damage to the device. These are stress ratings only, and functional operation of the device at these or any other conditions beyond those indicated under *Recommended Operating Conditions* is not implied. Exposure to *Absolute Maximum Ratings* for extended periods can affect device reliability.

Recommended Operating Conditions

| Symbol | Parameter | Min | Max | Unit |
|----------|-------------------------------|-----|------|------------------|
| V_{IN} | Supply Voltage | 2.5 | 5.5 | V |
| T_J | Junction Temperature Range | -40 | +125 | $^\circ\text{C}$ |
| T_A | Operating Ambient Temperature | -40 | +85 | $^\circ\text{C}$ |

Electrical Characteristics (@ $T_A = +25^\circ\text{C}$, $V_{IN} = 5.0\text{V}$, $V_{OUT} = 2.5\text{V}$, $C_{OUT} = 10\mu\text{F}$, $L = 2.2\mu\text{H}$, unless otherwise specified.)

| Symbol | Parameter | Condition | Min | Typ | Max | Unit |
|--------------|-------------------------------------|-----------------------------------|-------|------|----------|------------------|
| V_{IN} | Input Voltage Range | — | 2.5 | — | 5.5 | V |
| V_{OUT} | Output Voltage Range | — | 0.6 | — | V_{IN} | V |
| I_Q | Quiescent Current | $V_{FB} = 0.65\text{V}$ | — | 40 | — | μA |
| I_{SD} | Shutdown Current | $V_{EN} = 0\text{V}$ | — | 0.1 | 1 | μA |
| V_{FB} | Regulated Feedback Voltage | — | 0.588 | 0.6 | 0.612 | V |
| I_{FB} | FB Leakage Current | $V_{FB} = 1\text{V}$ | — | — | 0.2 | μA |
| I_{LIM} | Peak Inductor Current | — | 1.3 | — | — | A |
| fosc | Oscillator Frequency | — | — | 1.5 | — | MHz |
| $R_{DS(ON)}$ | Drain-Source On-State Resistance | $I_{SW} = 100\text{mA}$ High Side | — | 250 | — | m Ω |
| | | $I_{SW} = 100\text{mA}$ Low Side | — | 170 | — | m Ω |
| R_{DISCH} | Output Discharge Switch On Resistor | — | — | 2.1 | — | k Ω |
| V_{ENH} | EN Threshold High | — | 1.5 | — | — | V |
| V_{ENL} | EN Threshold Low | — | — | — | 0.4 | V |
| I_{EN} | EN Leakage Current | $V_{IN} = V_{EN} = 5\text{V}$ | -1.0 | — | 1.0 | μA |
| V_{UVLO} | Input UVLO Threshold | — | — | 2.4 | 2.7 | V |
| V_{HYS} | UVLO Hysteresis | — | — | 0.1 | — | V |
| T_{OTP} | Over Temperature Protection | — | — | +160 | — | $^\circ\text{C}$ |
| T_{OTH} | OTP Hysteresis | — | — | +15 | — | $^\circ\text{C}$ |
| tss | Soft-Start Time | — | — | 2 | — | ms |

Performance Characteristics (@ $T_A = +25^\circ\text{C}$, $V_{IN} = 5\text{V}$, $V_{OUT} = 1.8\text{V}$, unless otherwise specified.)

Efficiency vs. Load Current

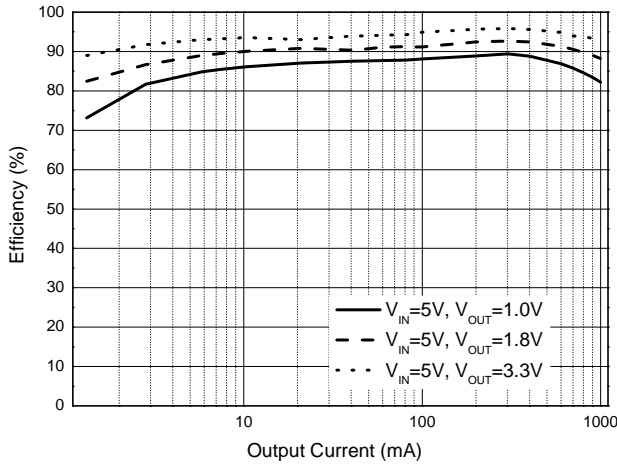

Feedback Reference Voltage vs. Temperature

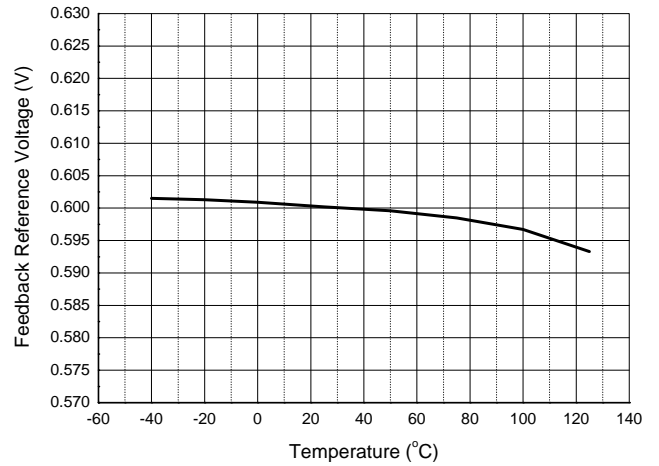

PFET Drain-Source On-State Resistance vs. Temperature

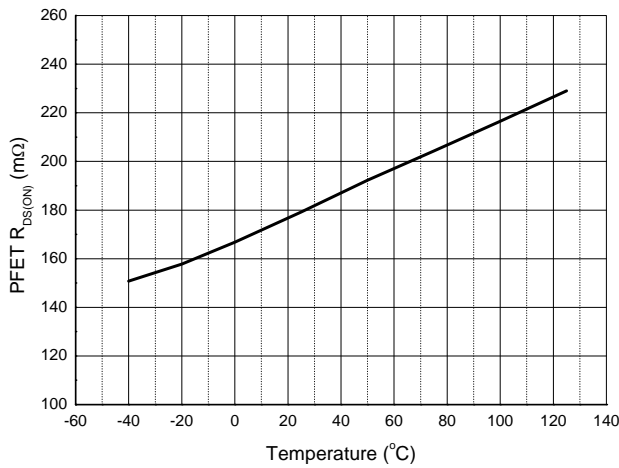

NFET Drain-Source On-State Resistance vs. Temperature

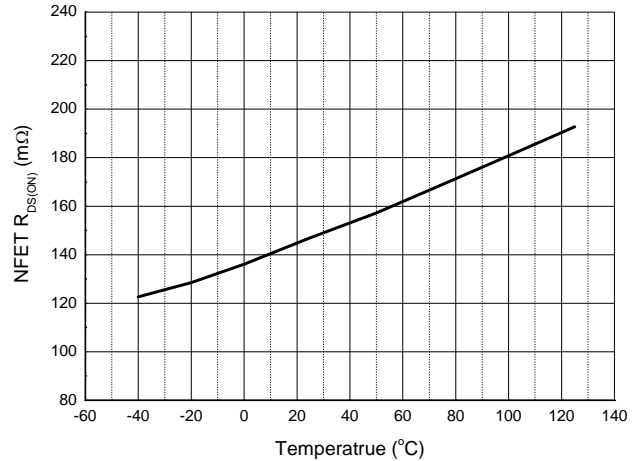

Quiescent Current vs. Temperature

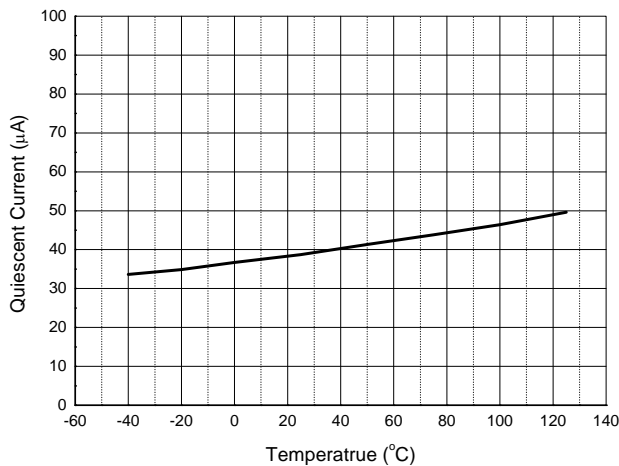

Oscillation Frequency vs. Temperature

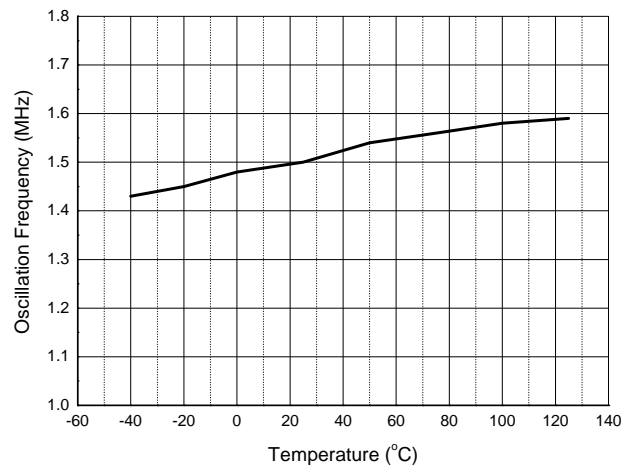

Performance Characteristics (@ $T_A = +25^\circ\text{C}$, $V_{IN} = 5\text{V}$, $V_{OUT} = 1.8\text{V}$, unless otherwise specified.) (continued)

Enable Turn On Characteristic ($I_{OUT} = 1\text{A}$)

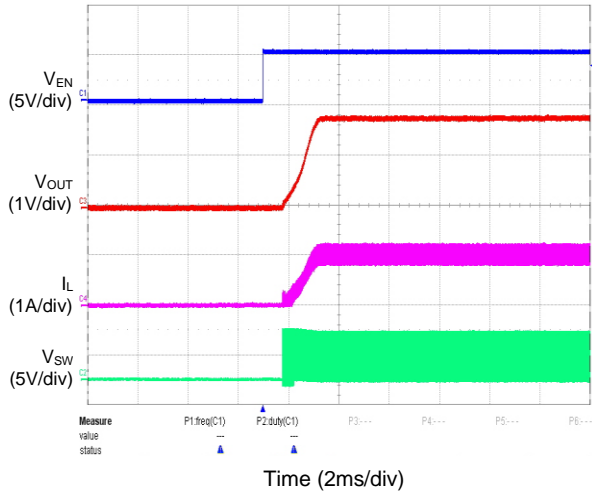

Enable Turn Off Characteristic ($I_{OUT} = 1\text{A}$)

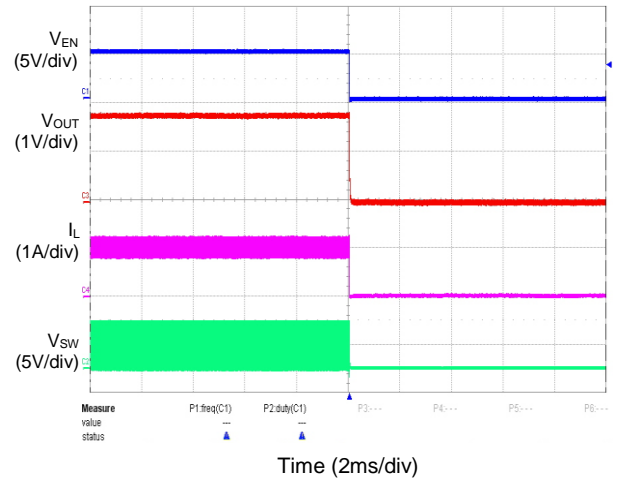

Short Current Protection ($I_{OUT} = 1\text{A}$)

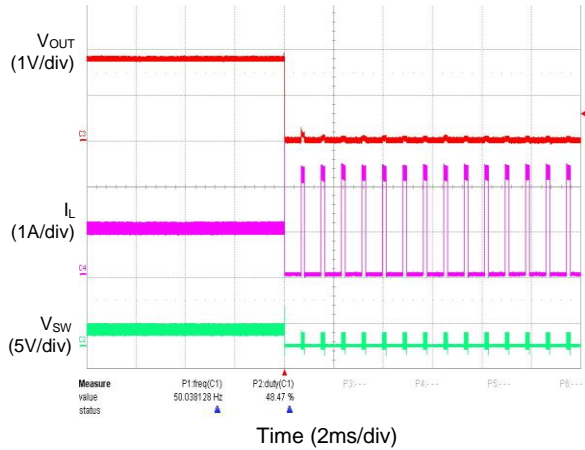

SCP Recovery ($I_{OUT} = 1\text{A}$)

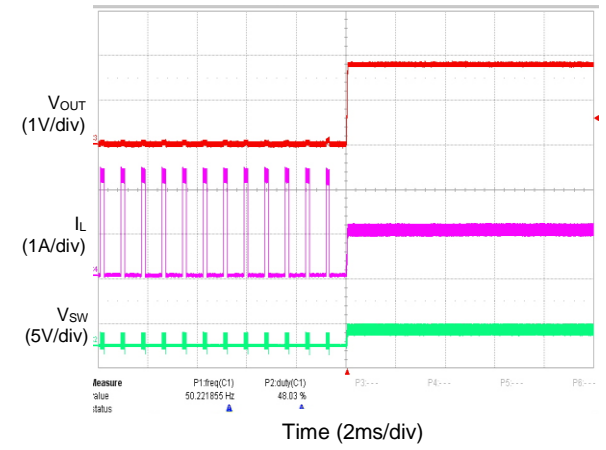

Load Transient ($I_{OUT} = 0.1\text{A}$ to 1A)

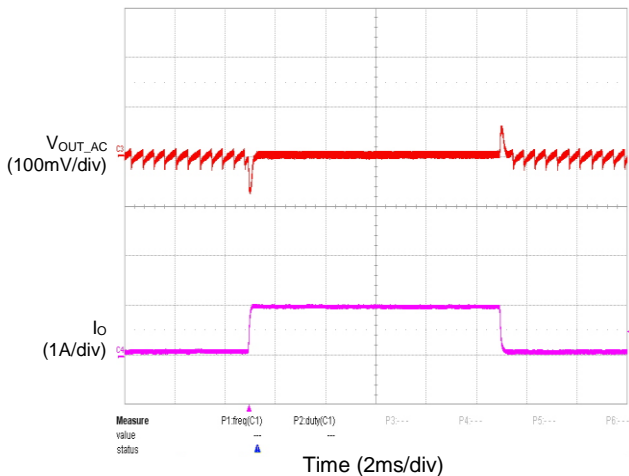

Load Transient ($I_{OUT} = 0.5\text{A}$ to 1A)

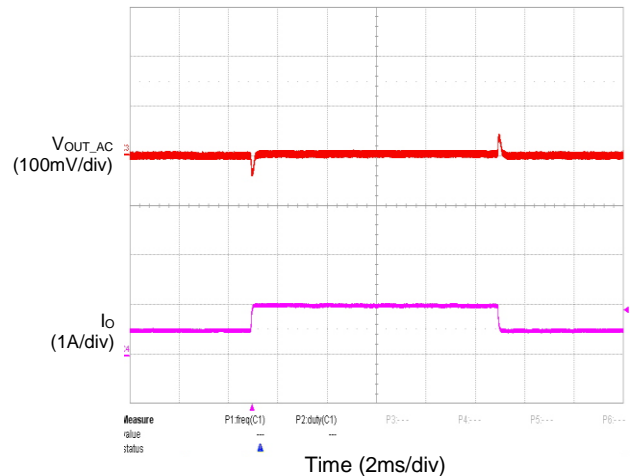

Application Information

Typical application circuit is shown in the *Typical Applications Circuit* and for the circuit parameters setting please refers to the following descriptions.

Under Voltage Lockout (UVLO) Circuit

When the V_{IN} drops lower than the UVLO detector threshold, the UVLO circuit starts to operate, V_{REF} stops, and high-side switch and low-side switch built-in switch transistors turn "OFF". As a result, V_{OUT} drops according to the C_{OUT} capacitance value and the load. When the V_{IN} is rising higher than UVLO released voltage, the IC will restart the operation.

Short Circuit Protection and Recovery

When the AP3428/A output node is shorted to GND that V_{FB} drops under 0.42V, AP3428/A will enter hiccup mode to protect itself. If short circuit is removed, and V_{FB} rises over 0.42V, the AP3428/A recovers to normal operation again. If the AP3428/A reaches OCP threshold while short circuit, the AP3428/A will enter cycle by cycle current limit mode until the current under OCP threshold.

Over Temperature Protection

The internal thermal temperature protection circuitry is provided to protect the integrated circuit in the event that the maximum junction temperature is exceeded. When the junction temperature exceeds +160°C, it shuts down the internal control circuit and switching power MOSFET. The AP3428/A will restart automatically under the control of soft start circuit when the junction temperature decreases to +145°C.

Setting the Output Voltage

The output voltage can be adjusted from 1 to 5V using an external resistor divider. Table 1 shows a list of resistor selections for common output voltages. Resistor R1 is selected based on a design tradeoff between efficiency and output voltage accuracy. For high values of R1 there is less current consumption in the feedback network. However the tradeoff is output voltage accuracy due to the bias current in the error amplifier. R1 can be determined by the following equation. Meanwhile, the input capacitor should close to IC for preventing unexpected influences.

$$R1 = R2 \cdot \left(\frac{V_{out}}{0.6} - 1 \right)$$

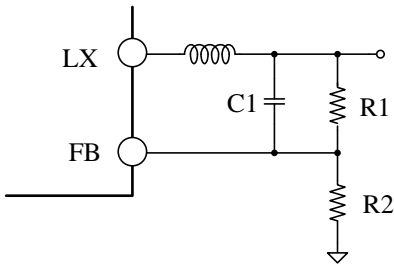

| Out Voltage | R1 | R2 | C1 |
|-------------|-------|-------|------|
| 1.0V | 91kΩ | 120kΩ | 22pF |
| 1.2V | 100kΩ | 100kΩ | 22pF |
| 1.5V | 150kΩ | 100kΩ | 22pF |
| 1.8V | 300kΩ | 150kΩ | 22pF |
| 2.5V | 380kΩ | 120kΩ | 22pF |
| 2.8V | 440kΩ | 120kΩ | 22pF |
| 3.3V | 430kΩ | 100kΩ | 22pF |

Figure 1. Feedback Divider Network

Table 1. Resistor Selection for Common Output

Ordering Information

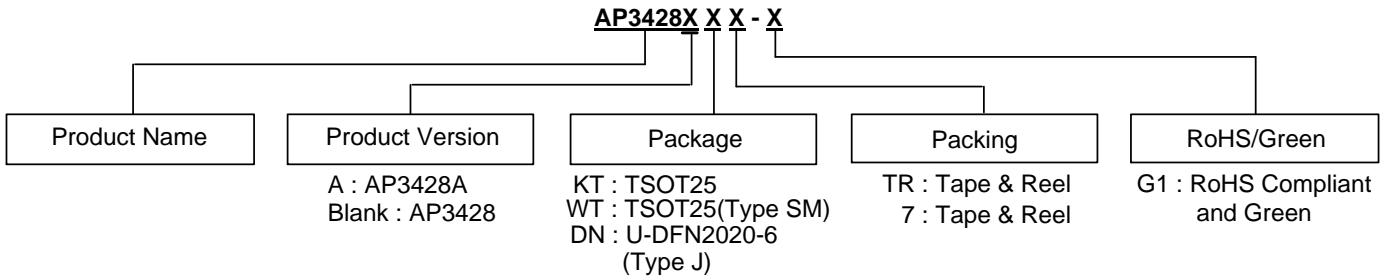

| Part Number | Status | Package | Identification Code | Temperature Range | Packing |
|----------------|--------|---------------------|---------------------|-------------------|------------------|
| AP3428AKTTR-G1 | NRND | TSOT25 | L2J | -40 to +85°C | 3000/Tape & Reel |
| AP3428KTTR-G1 | NRND | TSOT25 | L2H | -40 to +85°C | 3000/Tape & Reel |
| AP3428DNTR-G1 | Active | U-DFN2020-6(Type J) | CQ | -40 to +85°C | 3000/Tape & Reel |
| AP3428AWT-7 | Active | TSOT25 (Type SM) | BD | -40 to +85°C | 3000/Tape & Reel |
| AP3428WT-7 | Active | TSOT25 (Type SM) | BC | -40 to +85°C | 3000/Tape & Reel |

Note 5: NRND = Not Recommended for New Design.

Marking Information

TSOT25 (Type SM) for AP3428WT-7 and AP3428AWT-7

(Top View)

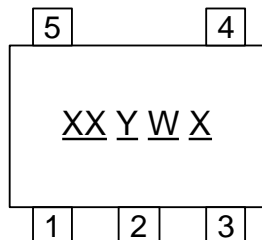

- XX : Identification Code
- Y : Year 0 to 9
- W : Week : A to Z : 1 to 26 week;
a to z : 27 to 52 week; z represents
52 and 53 week
- X : Internal Code

| Part Number | Package | Identification Code |
|-------------|------------------|---------------------|
| AP3428WT-7 | TSOT25 (Type SM) | BC |
| AP3428AWT-7 | TSOT25 (Type SM) | BD |

Marking Information (continued)

(1) TSOT25 for AP3428

(Top View)



First Line: Logo and Marking ID

(2) TSOT25 for AP3428A

(Top View)



First Line: Logo and Marking ID

(3) U-DFN2020-6 (Type J)

(Top View)

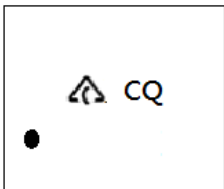

First Line: Logo and Marking ID

Package Outline Dimensions

Please see <http://www.diodes.com/package-outlines.html> for the latest version.

(1) Package Type: TSOT25 (Type SM)

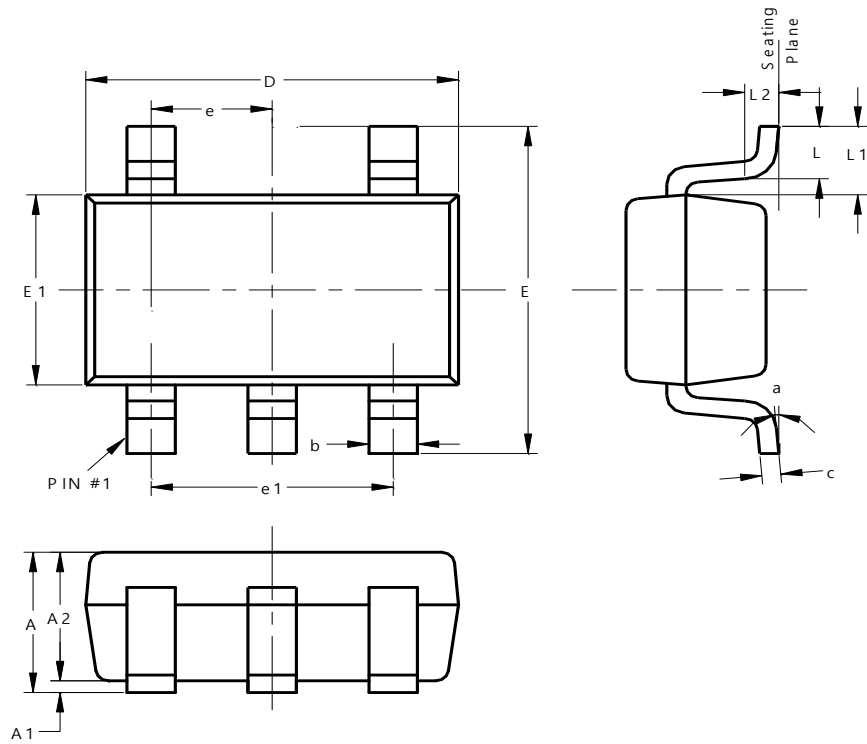

| TSOT25 (Type SM) | | | |
|----------------------|----------|------|------|
| Dim | Min | Max | Typ |
| A | 0.70 | 0.90 | -- |
| A1 | 0.00 | 0.10 | -- |
| A2 | 0.70 | 0.80 | 0.75 |
| b | 0.35 | 0.50 | -- |
| c | 0.08 | 0.20 | -- |
| D | 2.82 | 3.02 | 2.92 |
| E | 2.65 | 2.95 | 2.80 |
| E1 | 1.60 | 1.70 | 1.65 |
| e | 0.95 BSC | | |
| e1 | 1.90 BSC | | |
| L | 0.30 | 0.60 | 0.40 |
| L1 | 0.59 REF | | |
| L2 | 0.25 BSC | | |
| a | 0° | 8° | -- |
| All Dimensions in mm | | | |

Package Outline Dimensions (continued)

Please see <http://www.diodes.com/package-outlines.html> for the latest version.

(2) Package Type: TSOT25

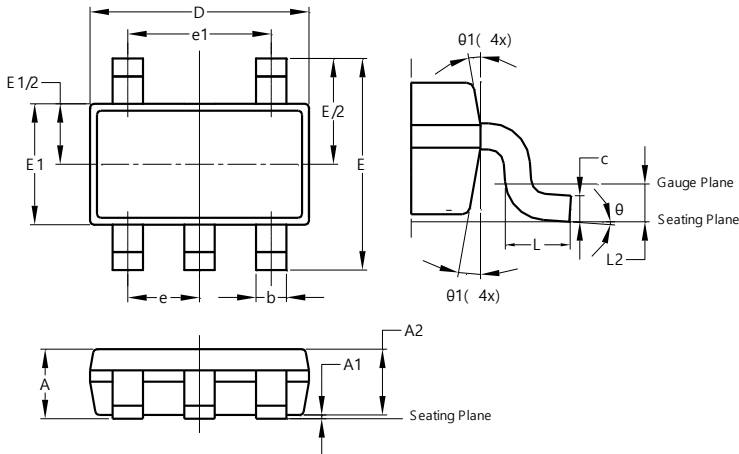

| TSOT25 | | | |
|----------------------|----------|------|------|
| Dim | Min | Max | Typ |
| A | - | 1.00 | - |
| A1 | 0.01 | 0.10 | - |
| A2 | 0.84 | 0.90 | - |
| b | 0.30 | 0.45 | - |
| c | 0.12 | 0.20 | - |
| D | - | - | 2.90 |
| E | - | - | 2.80 |
| E1 | - | - | 1.60 |
| e | 0.95 BSC | | |
| e1 | 1.90 BSC | | |
| L | 0.30 | 0.50 | - |
| L2 | 0.25 BSC | | |
| theta | 0° | 8° | 4° |
| theta1 | 4° | 12° | - |
| All Dimensions in mm | | | |

(3) Package Type: U-DFN2020-6 (Type J)

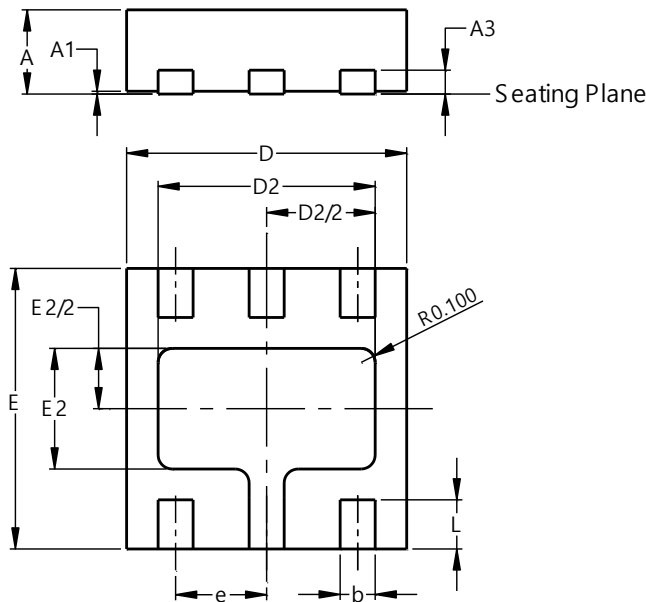

| U-DFN2020-6 (Type J) | | | |
|-------------------------|----------|-------|-------|
| Dim | Min | Max | Typ |
| A | 0.50 | 0.60 | -- |
| A1 | 0.00 | 0.05 | 0.03 |
| A3 | -- | -- | 0.203 |
| b | 0.20 | 0.30 | 0.25 |
| D | 1.95 | 2.075 | 2.00 |
| D2 | 1.45 | 1.65 | 1.55 |
| E | 1.95 | 2.075 | 2.00 |
| E2 | 0.76 | 0.96 | 0.86 |
| e | 0.65 BSC | | |
| L | 0.30 | 0.40 | 0.35 |
| All Dimensions in mm | | | |

Suggested Pad Layout

Please see <http://www.diodes.com/package-outlines.html> for the latest version.

(1) Package Type: TSOT25 (Type SM)

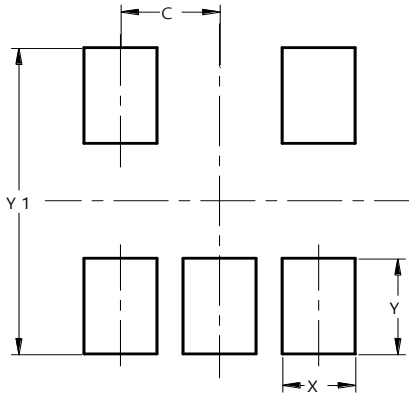

| Dimensions | Value (in mm) |
|------------|---------------|
| C | 0.950 |
| X | 0.700 |
| Y | 1.000 |
| Y1 | 3.199 |

(2) Package Type: TSOT25

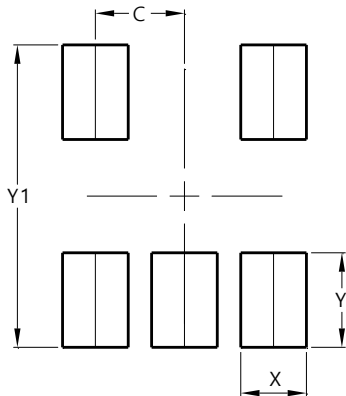

| Dimensions | Value (in mm) |
|------------|---------------|
| C | 0.950 |
| X | 0.700 |
| Y | 1.000 |
| Y1 | 3.199 |

(3) Package Type: U-DFN2020-6 (Type J)

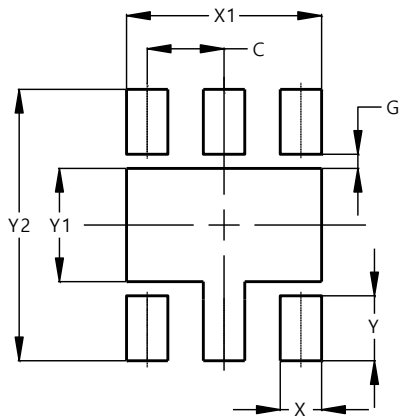

| Dimensions | Value (in mm) |
|------------|---------------|
| C | 0.650 |
| G | 0.120 |
| X | 0.350 |
| X1 | 1.650 |
| Y | 0.550 |
| Y1 | 0.960 |
| Y2 | 2.300 |

Mechanical Data

TSOT25/TSOT25 (Type SM)

- Moisture Sensitivity: Level 3 per J-STD-020
- Terminals: Finish - Mate Tin Plated Leads, Solderable per MIL-STD-202, Method 208 ^(e3)
- Weight: 0.014 grams (Approximate)

U-DFN2020-6 (Type J)

- Moisture Sensitivity: Level 1 per J-STD-020
- Terminals: Finish - NiPdAu over Copper Leads, Solderable per MIL-STD-202, Method 208 ^(e4)
- Weight: 0.007 grams (Approximate)

IMPORTANT NOTICE

1. DIODES INCORPORATED AND ITS SUBSIDIARIES ("DIODES") MAKE NO WARRANTY OF ANY KIND, EXPRESS OR IMPLIED, WITH REGARDS TO ANY INFORMATION CONTAINED IN THIS DOCUMENT, INCLUDING, BUT NOT LIMITED TO, THE IMPLIED WARRANTIES OF MERCHANTABILITY, FITNESS FOR A PARTICULAR PURPOSE OR NON-INFRINGEMENT OF THIRD PARTY INTELLECTUAL PROPERTY RIGHTS (AND THEIR EQUIVALENTS UNDER THE LAWS OF ANY JURISDICTION).
2. The Information contained herein is for informational purpose only and is provided only to illustrate the operation of Diodes products described herein and application examples. Diodes does not assume any liability arising out of the application or use of this document or any product described herein. This document is intended for skilled and technically trained engineering customers and users who design with Diodes products. Diodes products may be used to facilitate safety-related applications; however, in all instances customers and users are responsible for (a) selecting the appropriate Diodes products for their applications, (b) evaluating the suitability of the Diodes products for their intended applications, (c) ensuring their applications, which incorporate Diodes products, comply the applicable legal and regulatory requirements as well as safety and functional-safety related standards, and (d) ensuring they design with appropriate safeguards (including testing, validation, quality control techniques, redundancy, malfunction prevention, and appropriate treatment for aging degradation) to minimize the risks associated with their applications.
3. Diodes assumes no liability for any application-related information, support, assistance or feedback that may be provided by Diodes from time to time. Any customer or user of this document or products described herein will assume all risks and liabilities associated with such use, and will hold Diodes and all companies whose products are represented herein or on Diodes' websites, harmless against all damages and liabilities.
4. Products described herein may be covered by one or more United States, international or foreign patents and pending patent applications. Product names and markings noted herein may also be covered by one or more United States, international or foreign trademarks and trademark applications. Diodes does not convey any license under any of its intellectual property rights or the rights of any third parties (including third parties whose products and services may be described in this document or on Diodes' website) under this document.
5. Diodes products are provided subject to Diodes' Standard Terms and Conditions of Sale (<https://www.diodes.com/about/company/terms-and-conditions/terms-and-conditions-of-sales/>) or other applicable terms. This document does not alter or expand the applicable warranties provided by Diodes. Diodes does not warrant or accept any liability whatsoever in respect of any products purchased through unauthorized sales channel.
6. Diodes products and technology may not be used for or incorporated into any products or systems whose manufacture, use or sale is prohibited under any applicable laws and regulations. Should customers or users use Diodes products in contravention of any applicable laws or regulations, or for any unintended or unauthorized application, customers and users will (a) be solely responsible for any damages, losses or penalties arising in connection therewith or as a result thereof, and (b) indemnify and hold Diodes and its representatives and agents harmless against any and all claims, damages, expenses, and attorney fees arising out of, directly or indirectly, any claim relating to any noncompliance with the applicable laws and regulations, as well as any unintended or unauthorized application.
7. While efforts have been made to ensure the information contained in this document is accurate, complete and current, it may contain technical inaccuracies, omissions and typographical errors. Diodes does not warrant that information contained in this document is error-free and Diodes is under no obligation to update or otherwise correct this information. Notwithstanding the foregoing, Diodes reserves the right to make modifications, enhancements, improvements, corrections or other changes without further notice to this document and any product described herein. This document is written in English but may be translated into multiple languages for reference. Only the English version of this document is the final and determinative format released by Diodes.
8. Any unauthorized copying, modification, distribution, transmission, display or other use of this document (or any portion hereof) is prohibited. Diodes assumes no responsibility for any losses incurred by the customers or users or any third parties arising from any such unauthorized use.

Copyright © 2021 Diodes Incorporated

www.diodes.com

Looking for pricing, stock, or lifecycle information?

Click below to explore more details on WIN SOURCE:

 [View AP3428KTTR-G1 on WIN SOURCE](#)

 [Diodes Incorporated Information](#)

Optimize Your Supply Chain with WIN SOURCE Solutions

-  Global Sourcing Solution
-  Obsolete Management
-  Cost Control Management
-  Shortage Management
-  Alternative Solution
-  Excess Inventory Management