



**THE DATASHEET OF
AP2822GKETR-G1-01**



General Description

The AP2822 is an integrated high-side power switch that consists of N-Channel MOSFET, charge pump, over current & temperature and other related protection circuits. The switch's low $R_{DS(ON)}$, 85m Ω , is designed to meet USB voltage drop requirements. The IC includes soft-start to limit inrush current, over-current protection, load short protection with fold-back, and thermal shutdown to avoid switch failure during hot plug-in. Under voltage lockout (UVLO) function is used to ensure the device remain off unless there is a valid input voltage present. A FLAG output is available to indicate fault conditions to the local USB controller.

The AP2822 is available in the standard package of SOT-23-5.

Features

- Low MOSFET On Resistance: 85m Ω
- Compliant to USB Specifications
- Available 4 Versions of Continuous Load: 0.5A/1.0A/1.5A/2.0A
- Logic Level Enable Pin: Available with Active-high or Active-low Version
- Operating Voltage Range: 2.7V to 5.5V
- Low Supply Current: 68 μ A (Typ.)
- Low Shutdown Current: 1.0 μ A (Max)
- Under-voltage Lockout
- Soft Start-up
- Over-current Protection
- Over Temperature Protection
- Load Short Protection with Fold-back
- No Reverse Current When Power Off
- Deglitched FLAG Output with Open Drain
- With Output Shutdown Pull-low Resistor

Applications

- USB Power Management
- USB Bus/Self Powered Hubs
- Hot-plug Power Supplies
- Battery-charger Circuits
- Notebooks, Motherboard PCs

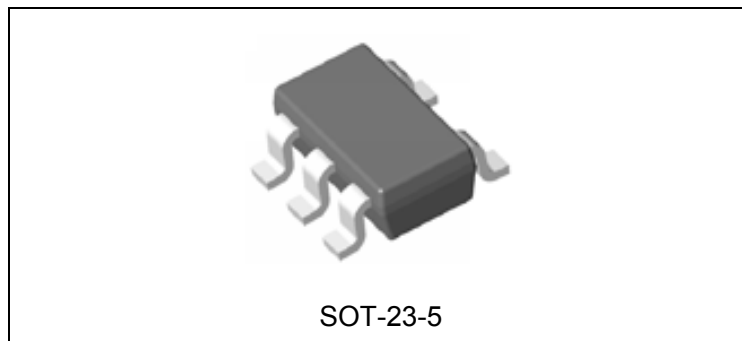

Figure 1. Package Type of AP2822

Pin Configuration

K/KA/KB/KE Package
(SOT-23-5)

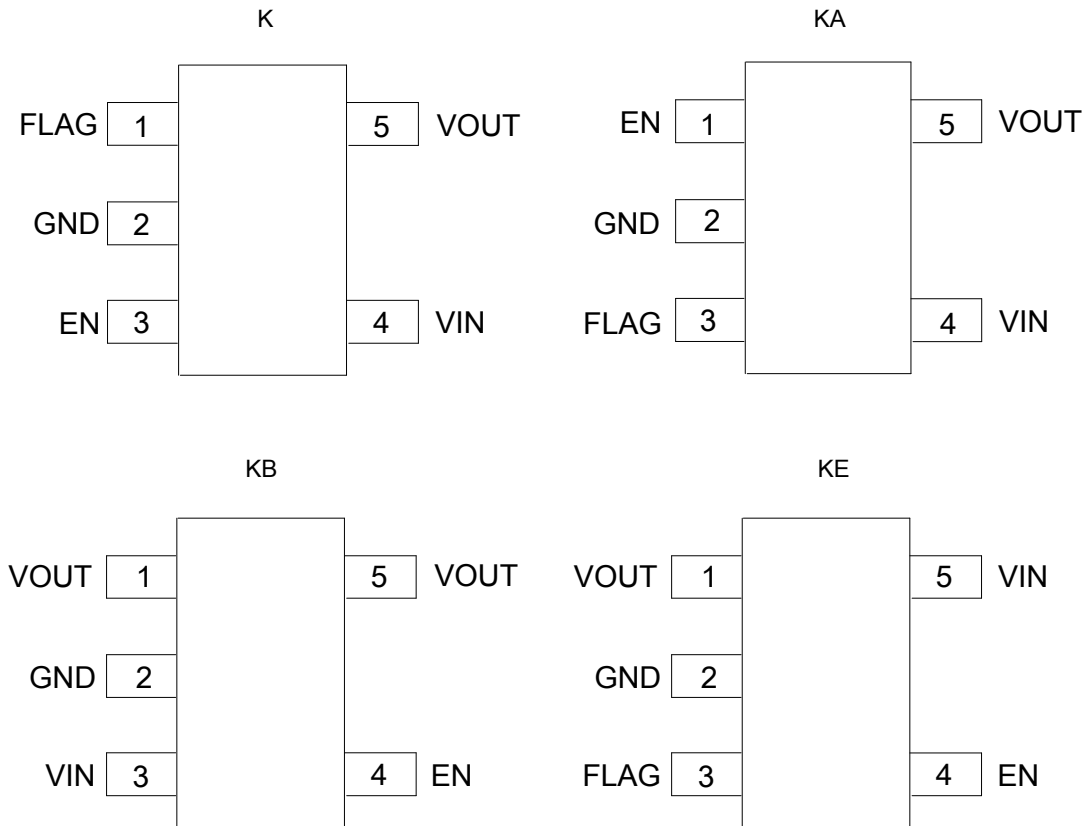
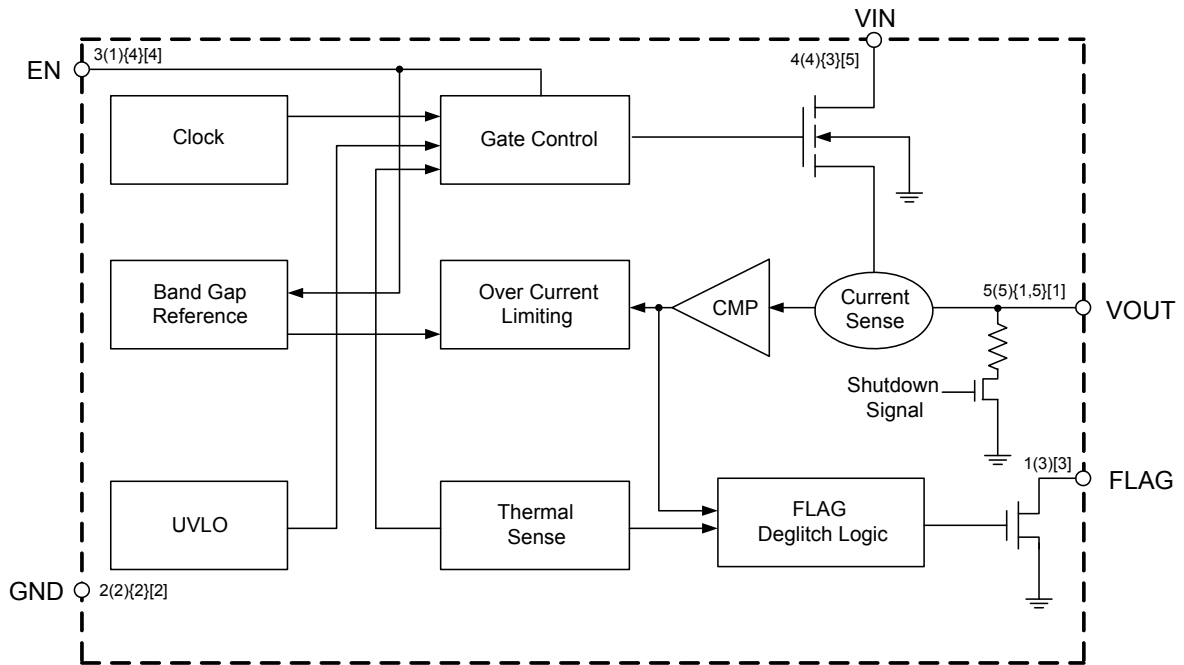

Figure 2. Pin Configuration of AP2822 (Top View)

**Pin Descriptions**

Pin Number	Pin Name	Function
1(K)	FLAG	Fault flag pin, output with open drain, need a pull-up resistor in application, active low to indicate OCP or OTP
3(KA/KE)		
2	GND	Ground
3(K)	EN	Chip enable control input, active low or high
1(KA)		
4(KB/KE)		
4(K/KA)	VIN	Supply input pin
3(KB)		
5(KE)		
5(K/KA)	VOUT	Switch output voltage
1,5(KB)		
1(KE)		

Functional Block Diagram



A(B){C}[D]

- A: SOT-23-5(K Package)
- B: SOT-23-5(KA Package)
- C: SOT-23-5(KB Package)
- D: SOT-23-5(KE Package)

Figure 3. Functional Block Diagram of AP2822



0.5A to 2.0A High-side Power Distribution Switches

AP2822

Ordering Information

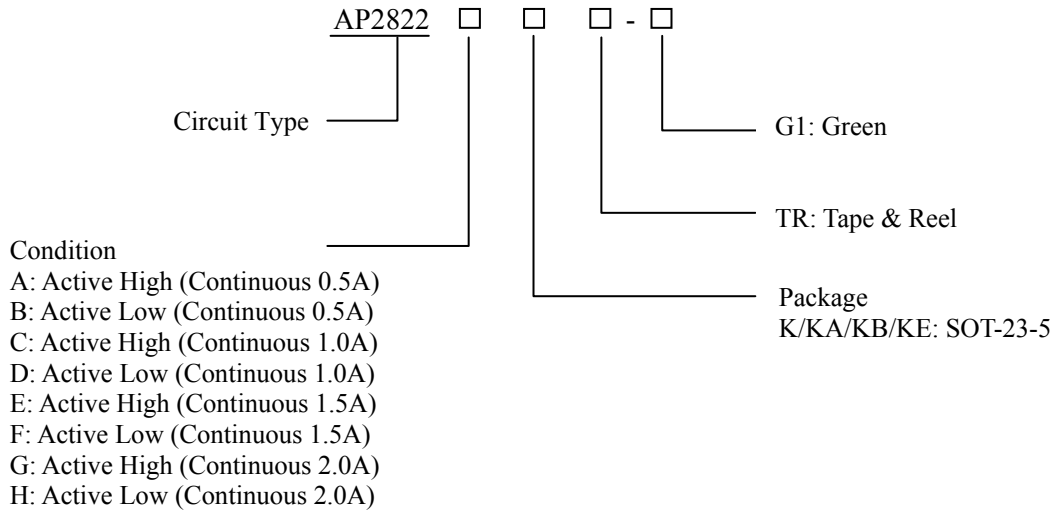

Package	Temperature Range	Condition	Part Number	Marking ID	Packing Type
SOT-23-5	-40 to 85°C	Active High (Continuous 0.5A)	AP2822AKTR-G1	GCQ	Tape & Reel
		Active Low (Continuous 0.5A)	AP2822BKTR-G1	GCR	Tape & Reel
		Active High (Continuous 1.0A)	AP2822CKTR-G1	GCS	Tape & Reel
		Active Low (Continuous 1.0A)	AP2822DKTR-G1	GCT	Tape & Reel
		Active High (Continuous 1.5A)	AP2822EKTR-G1	GCU	Tape & Reel
		Active Low (Continuous 1.5A)	AP2822FKTR-G1	GCV	Tape & Reel
		Active High (Continuous 2.0A)	AP2822GKTR-G1	GCW	Tape & Reel
		Active Low (Continuous 2.0A)	AP2822HKTR-G1	GCZ	Tape & Reel

**0.5A to 2.0A High-side Power Distribution Switches****AP2822****Ordering Information (Continued)**

Package	Temperature Range	Condition	Part Number	Marking ID	Packing Type
SOT-23-5	-40 to 85°C	Active High (Continuous 0.5A)	AP2822AKATR-G1	GDQ	Tape & Reel
		Active Low (Continuous 0.5A)	AP2822BKATR-G1	GDR	Tape & Reel
		Active High (Continuous 1.0A)	AP2822CKATR-G1	GDS	Tape & Reel
		Active Low (Continuous 1.0A)	AP2822DKATR-G1	GDT	Tape & Reel
		Active High (Continuous 1.5A)	AP2822EKATR-G1	GDU	Tape & Reel
		Active Low (Continuous 1.5A)	AP2822FKATR-G1	GDV	Tape & Reel
		Active High (Continuous 2.0A)	AP2822GKATR-G1	GDW	Tape & Reel
		Active Low (Continuous 2.0A)	AP2822HKATR-G1	GDZ	Tape & Reel
SOT-23-5	-40 to 85°C	Active High (Continuous 0.5A)	AP2822AKBTR-G1	GLA	Tape & Reel
		Active Low (Continuous 0.5A)	AP2822BKBTR-G1	GLB	Tape & Reel
		Active High (Continuous 1.0A)	AP2822CKBTR-G1	GLC	Tape & Reel
		Active Low (Continuous 1.0A)	AP2822DKBTR-G1	GLD	Tape & Reel
		Active High (Continuous 1.5A)	AP2822EKBTR-G1	GLE	Tape & Reel
		Active Low (Continuous 1.5A)	AP2822FKBTR-G1	GLF	Tape & Reel
		Active High (Continuous 2.0A)	AP2822GKBTR-G1	GLG	Tape & Reel
		Active Low (Continuous 2.0A)	AP2822HKBTR-G1	GLH	Tape & Reel

**0.5A to 2.0A High-side Power Distribution Switches****AP2822****Ordering Information (Continued)**

Package	Temperature Range	Condition	Part Number	Marking ID	Packing Type
SOT-23-5	-40 to 85°C	Active High (Continuous 0.5A)	AP2822AKETR-G1	GLI	Tape & Reel
		Active Low (Continuous 0.5A)	AP2822BKETR-G1	GLJ	Tape & Reel
		Active High (Continuous 1.0A)	AP2822CKETR-G1	GLK	Tape & Reel
		Active Low (Continuous 1.0A)	AP2822DKETR-G1	GLL	Tape & Reel
		Active High (Continuous 1.5A)	AP2822EKETR-G1	GLM	Tape & Reel
		Active Low (Continuous 1.5A)	AP2822FKETR-G1	GLN	Tape & Reel
		Active High (Continuous 2.0A)	AP2822GKETR-G1	GLO	Tape & Reel
		Active Low (Continuous 2.0A)	AP2822HKETR-G1	GLP	Tape & Reel

BCD Semiconductor's Pb-free products, as designated with "G1" suffix in the part number, are RoHS compliant and green.

**Absolute Maximum Ratings (Note 1)**

Parameter	Symbol	Value	Unit
Power Supply Voltage	V_{IN}	6.0	V
Operating Junction Temperature Range	T_J	150	°C
Storage Temperature Range	T_{STG}	-65 to 150	°C
Lead Temperature (Soldering, 10sec)	T_{LEAD}	260	°C
Thermal Resistance (Junction to Ambient)	θ_{JA}	TBD	°C/W
ESD (Machine Model)		200	V
ESD (Human Body Model)		2000	V

Note 1: Stresses greater than those listed under “Absolute Maximum Ratings” may cause permanent damage to the device. These are stress ratings only, and functional operation of the device at these or any other conditions beyond those indicated under “Recommended Operating Conditions” is not implied. Exposure to “Absolute Maximum Ratings” for extended periods may affect device reliability.

Recommended Operating Conditions

Parameter	Symbol	Min	Max	Unit
Supply Voltage	V_{IN}	2.7	5.5	V
Operating Ambient Temperature Range	T_A	-40	85	°C



0.5A to 2.0A High-side Power Distribution Switches

AP2822

Electrical Characteristics

($V_{IN}=5.0V$, $C_{IN}=2.2\mu F$, $C_{OUT}=1.0\mu F$, Typical $T_A=25^\circ C$, unless otherwise specified)

Parameter	Symbol	Condition	Min	Typ	Max	Unit
Supply Voltage	V_{IN}		2.7		5.5	V
Switch On Resistance	$R_{DS(ON)}$	$V_{IN}=5.0V$, $I_{OUT}=2.0A$		85	110	m Ω
Current Limit	I_{LIMIT}	AP2822A/B(0.5A), $V_{OUT}=4.0V$	0.7	1.0	1.4	A
		AP2822C/D(1.0A), $V_{OUT}=4.0V$	1.1	1.5	2.1	
		AP2822E/F(1.5A), $V_{OUT}=4.0V$	1.65	2.2	2.8	
		AP2822G/H(2.0A), $V_{OUT}=4.0V$	2.2	2.7	3.2	
Supply Current	I_{SUPPLY}	$V_{IN}=5.0V$, No Load		68	95	μA
Fold-back Short Current	I_{SHORT}	AP2822 A/B/C/D, $V_{OUT}=0V$		0.7		A
		AP2822 E/F/G/H, $V_{OUT}=0V$		1.1		
Shutdown Supply Current	$I_{SHUTDOWN}$	Chip Disable, Shutdown Mode		0.1	1.0	μA
Enable High Input Threshold	V_{ENH}		1.6		5.5	V
Enable Low Input Threshold	V_{ENL}		0		1.0	V
Enable Pin Input Current	I_{EN}	Force 0V to 5.0V at EN Pin	-1.0		1.0	μA
Under Voltage Lockout Threshold Voltage	V_{UVLO}	V_{IN} Increasing from 0V	2.2	2.5	3.0	V
Under Voltage Hysteresis	V_{UVLOHY}			0.2		V
Reverse Current	$I_{REVERSE}$	Chip Disable, $V_{OUT}>V_{IN}$		0.1	1.0	μA
Output Pull Low Resistance after Shutdown	$R_{DISCHARGE}$			100	200	Ω
Output Turn-on Time	t_{ON}	From Enable Active to 90% of Output		500		μs
FLAG Pin Delay Time	t_{DFLG}	From Over Current Fault Condition to Flag Active	5	10	15	ms
FLAG Pin Low Voltage	V_{FLG}	$I_{SINK}=5.0mA$		35	70	mV
FLAG Pin Leakage Current	$I_{LEAKAGE}$	FLAG Disable, Force 5.0V			1.0	μA
Thermal Shutdown Temperature	T_{OTSD}			150		$^\circ C$
Thermal Shutdown Hysteresis	T_{HYOTSD}			30		



Typical Performance Characteristics

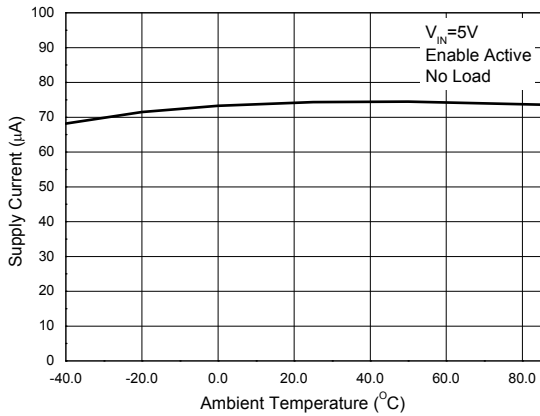

Figure 4. Supply Current vs. Ambient Temperature

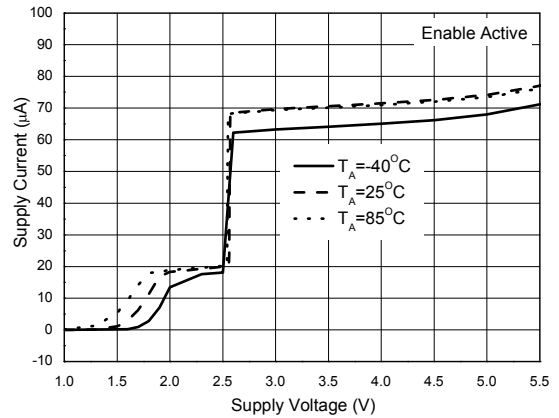

Figure 5. Supply Current vs. Supply Voltage

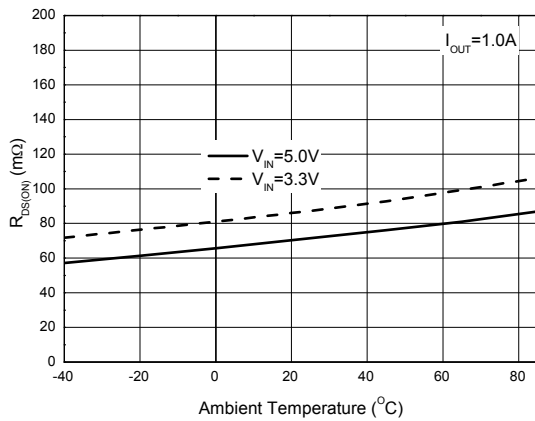

Figure 6. R_{DS(ON)} vs. Ambient Temperature

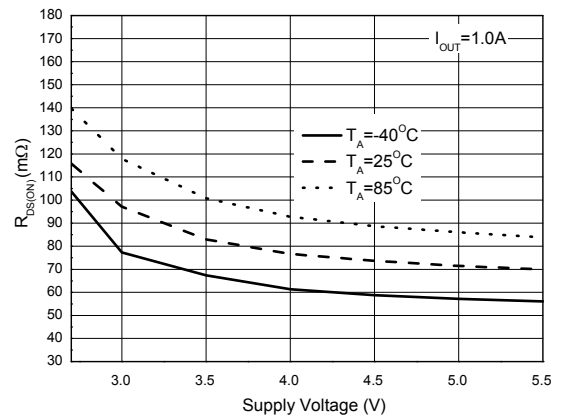

Figure 7. R_{DS(ON)} vs. Supply Voltage



Typical Performance Characteristics (Continued)

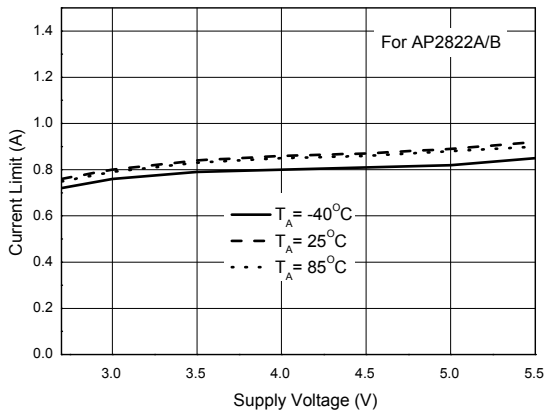

Figure 8. Current Limit vs. Supply Voltage

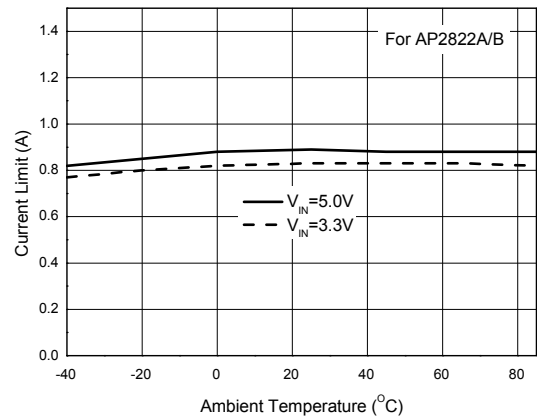

Figure 9. Current Limit vs. Ambient Temperature

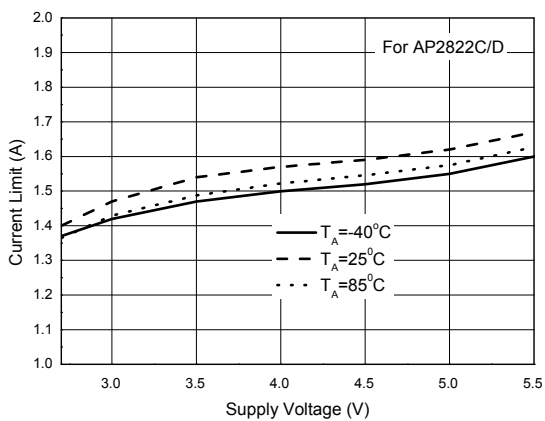

Figure 10. Current Limit vs. Supply Voltage

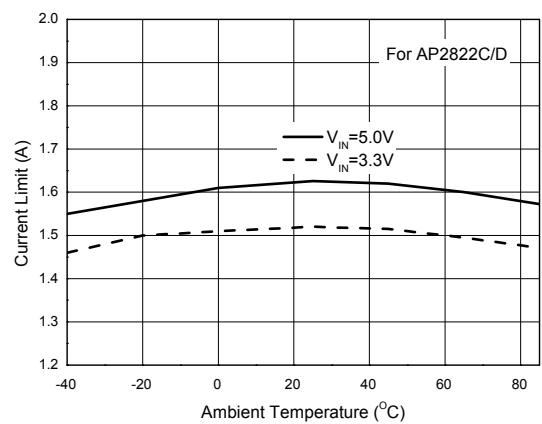

Figure 11. Current Limit vs. Ambient Temperature



Typical Performance Characteristics (Continued)

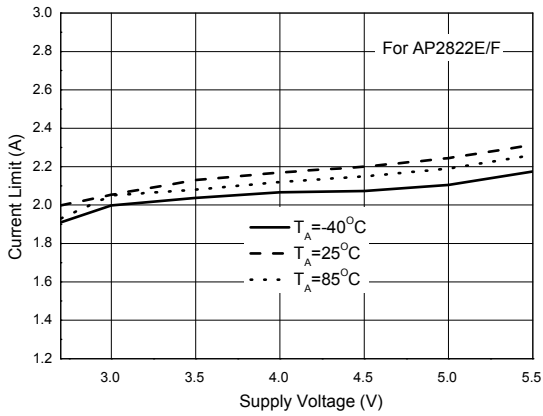

Figure 12. Current Limit vs. Supply Voltage

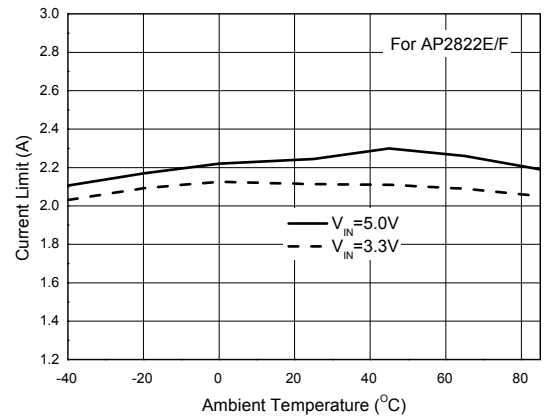

Figure 13. Current Limit vs. Ambient Temperature

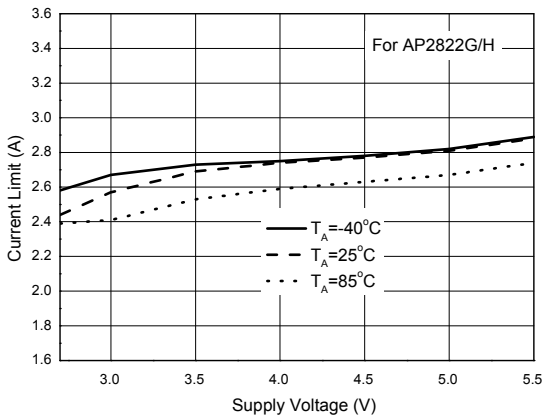

Figure 14. Current Limit vs. Supply Voltage

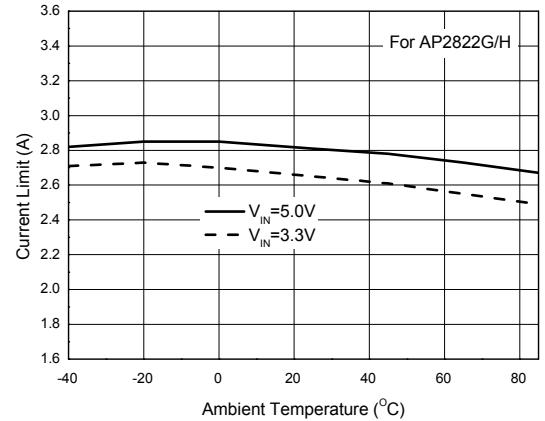

Figure 15. Current Limit vs. Ambient Temperature

Typical Performance Characteristics (Continued)

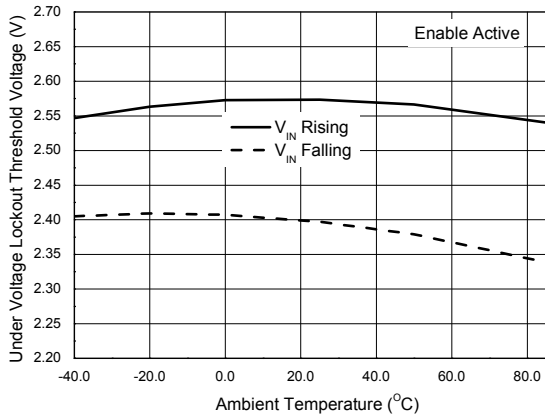

Figure 16. UVLO Voltage vs. Ambient Temperature

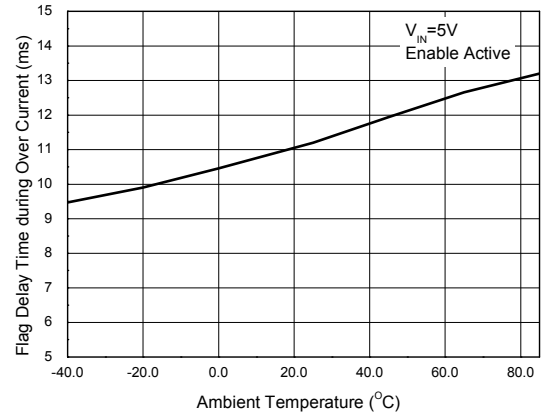

Figure 17. Flag Delay Time during Over Current vs. Ambient Temperature

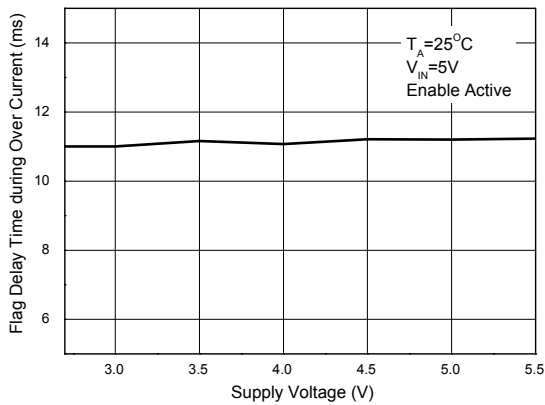

Figure 18. Flag Delay Time during Over Current vs. Supply Voltage

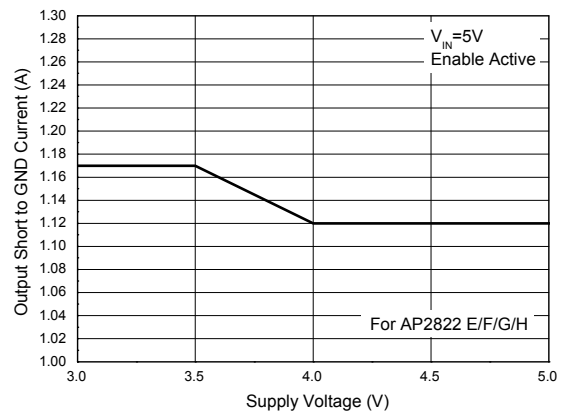

Figure 19. Output Short to GND Current vs. Supply Voltage

Typical Performance Characteristics (Continued)

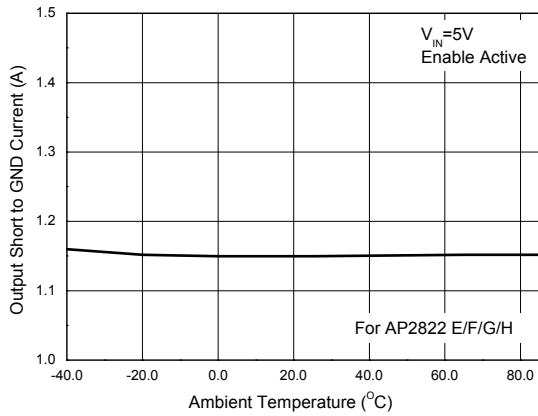

Figure 20. Output Short to GND Current vs. Ambient Temperature

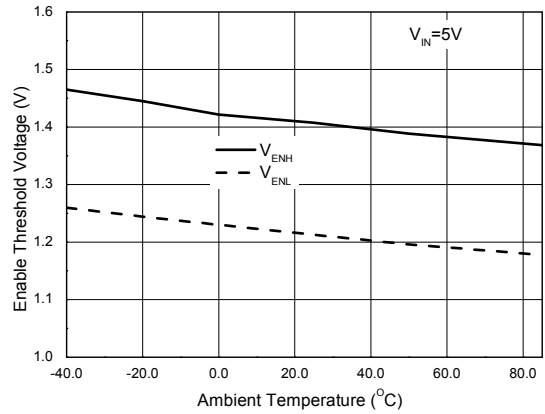

Figure 21. Enable Threshold Voltage vs. Ambient Temperature

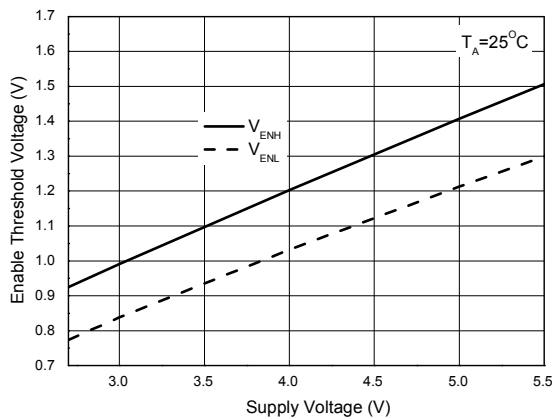

Figure 22. Enable Threshold Voltage vs. Supply Voltage

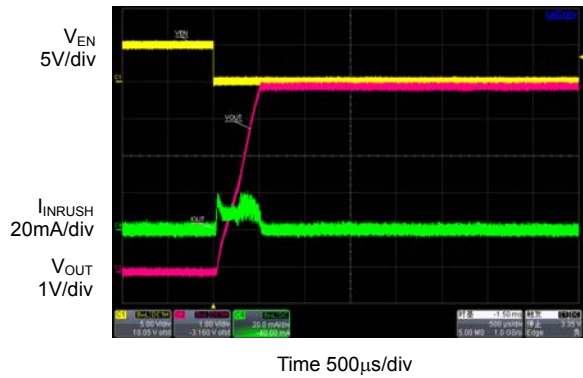

Figure 23. Output Turn On and Rise Time (C_{IN}=1.0µF, C_{OUT}=1.0µF, No Load)

Typical Performance Characteristics (Continued)



Time 500µs/div

Figure 24. Output Turn On and Rise Time ($C_{IN}=1.0\mu F$, $C_{OUT}=1.0\mu F$, $R_L=3.3\Omega$)

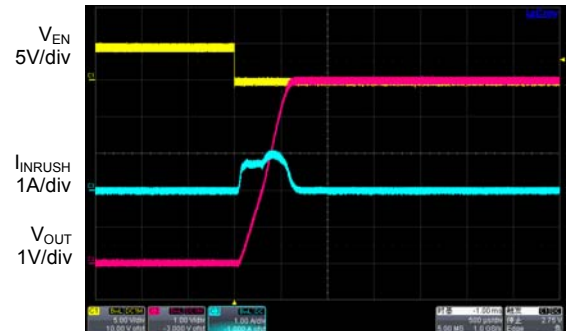

Time 500µs/div

Figure 25. Output Turn On and Rise Time ($C_{IN}=1.0\mu F$, $C_{OUT}=100\mu F$, No Load)

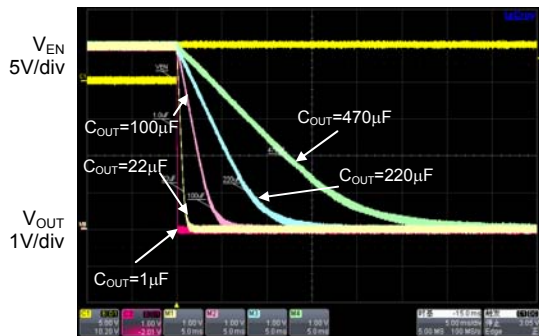

Time 5ms/div

Figure 26. Output Turn Off and Fall Time ($V_{IN}=5V$, $C_{IN}=1.0\mu F$, No Load)

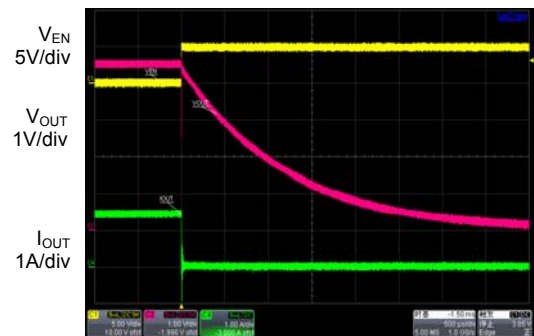

Time 500µs/div

Figure 27. Output Turn Off and Fall Time ($V_{IN}=5V$, $C_{IN}=1.0\mu F$, $C_{OUT}=470\mu F$, $R_L=3.3\Omega$)

Typical Performance Characteristics (Continued)



Time 20ms/div

Figure 28. Output Short to GND Current ($V_{IN}=5V$, $C_{IN}=1.0\mu F$)

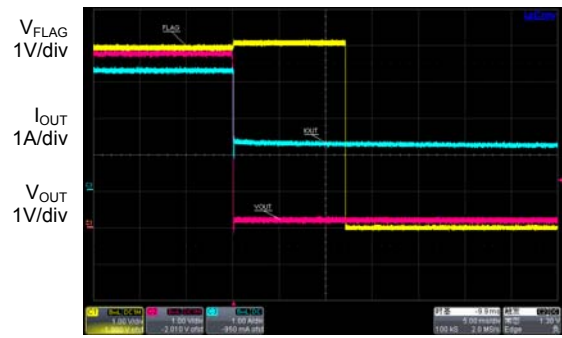

Time 5ms/div

Figure 29. FLAG Response during Over Current



Time 5ms/div

Figure 30. FLAG Response during Over Temperature ($T_A=125\text{ }^\circ\text{C}$)

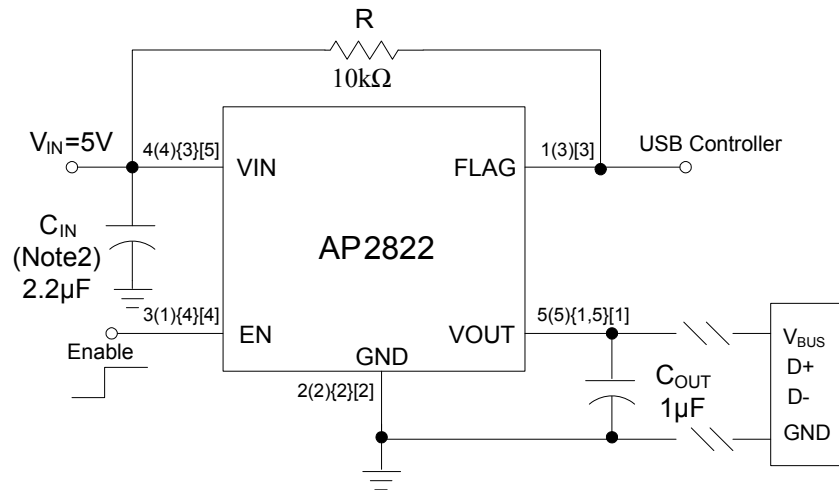
Typical Application

A(B){C}[D]
 A: SOT-23-5(K Package)
 B: SOT-23-5(KA Package)
 C: SOT-23-5(KB Package)
 D: SOT-23-5(KE Package)

Note 2: 2.2μF input capacitor is enough in most application cases.

If the VOUT is short to ground frequently during usage, large size input capacitor is necessary, recommend 22μF.

Figure 31. Typical Application of AP2822



Mechanical Dimensions

SOT-23-5

Unit: mm(inch)

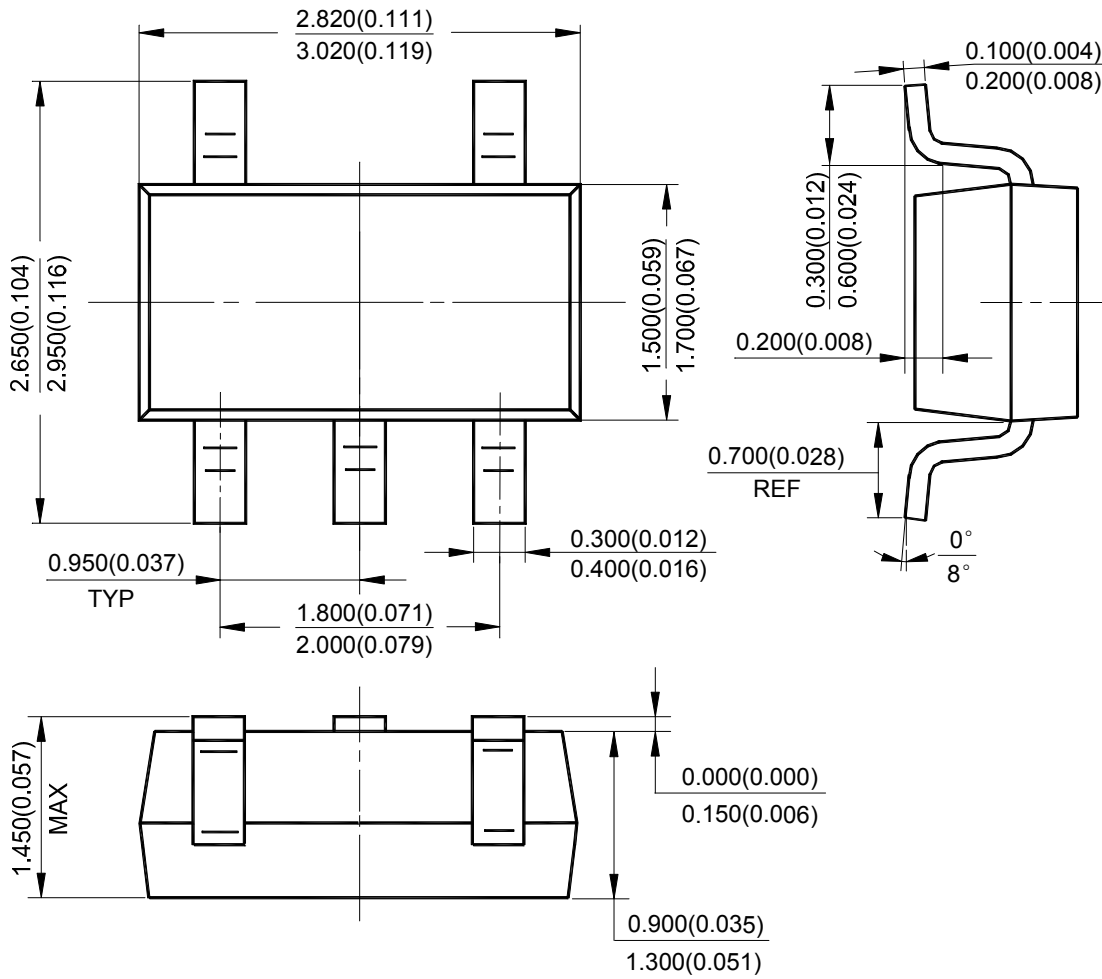



BCD Semiconductor Manufacturing Limited

<http://www.bcdsemi.com>

IMPORTANT NOTICE

BCD Semiconductor Manufacturing Limited reserves the right to make changes without further notice to any products or specifications herein. BCD Semiconductor Manufacturing Limited does not assume any responsibility for use of any its products for any particular purpose, nor does BCD Semiconductor Manufacturing Limited assume any liability arising out of the application or use of any its products or circuits. BCD Semiconductor Manufacturing Limited does not convey any license under its patent rights or other rights nor the rights of others.

MAIN SITE

- Headquarters

BCD Semiconductor Manufacturing Limited

No. 1600, Zi Xing Road, Shanghai ZiZhu Science-based Industrial Park, 200241, China
Tel: +86-21-24162266, Fax: +86-21-24162277

- Wafer Fab

Shanghai SIM-BCD Semiconductor Manufacturing Co., Ltd.

800 Yi Shan Road, Shanghai 200233, China
Tel: +86-21-6485 1491, Fax: +86-21-5450 0008

REGIONAL SALES OFFICE

Shenzhen Office

Shanghai SIM-BCD Semiconductor Manufacturing Co., Ltd., Shenzhen Office

Unit A Room 1203, Skyworth Bldg., Gaoxin Ave. 1.S., Nanshan District, Shenzhen, China
Tel: +86-755-8826 7951
Fax: +86-755-8826 7865

Taiwan Office

BCD Semiconductor (Taiwan) Company Limited

4F, 298-1, Rui Guang Road, Nei-Hu District, Taipei, Taiwan
Tel: +886-2-2656 2808
Fax: +886-2-2656 2806

USA Office

BCD Semiconductor Corp.

30920 Huntwood Ave. Hayward, CA 94544, USA
Tel : +1-510-324-2988
Fax: +1-510-324-2788

Looking for pricing, stock, or lifecycle information?

Click below to explore more details on WIN SOURCE:

-  [View AP2822GKETR-G1-01 on WIN SOURCE](#)
-  [Diodes Incorporated Information](#)

Optimize Your Supply Chain with WIN SOURCE Solutions

-  Global Sourcing Solution
-  Obsolete Management
-  Cost Control Management
-  Shortage Management
-  Alternative Solution
-  Excess Inventory Management