



**THE DATASHEET OF  
BA6254FS-E2**



# PNP transistor array

## BA6254FS

The BA6254FS has been developed as a low-saturation output, upper-side transistor array for low-voltage motor drive applications.

The three PNP transistors have a common emitter.

### ●Applications

Motor drivers

### ●Features

- 1) Output on resistance is low (0.4Ω Max.).
- 2) Three PNP transistors with common emitter.

### ●Absolute maximum ratings (Ta = 25°C)

Parameter	Symbol	Limits	Unit
Collector / base voltages	V <sub>CE0</sub>	-20	V
Collector / emitter voltage	V <sub>CEO</sub>	-20	V
Emitter / base voltage	V <sub>EB0</sub>	-6	V
Collector current	I <sub>c</sub>	-1	A
Power dissipation (collector)	P <sub>d</sub>	800*1	mW
Junction temperature	T <sub>j</sub>	150	°C
Operating temperature	T <sub>opr</sub>	-20~+75	°C
Storage temperature	T <sub>stg</sub>	-55~+150	°C

\*1 Reduced by 6.4mW for each increase in Ta of 1°C over 25°C  
(when mounted on a 70mm × 70mm × 1.6mm glass epoxy board).

● Block diagram

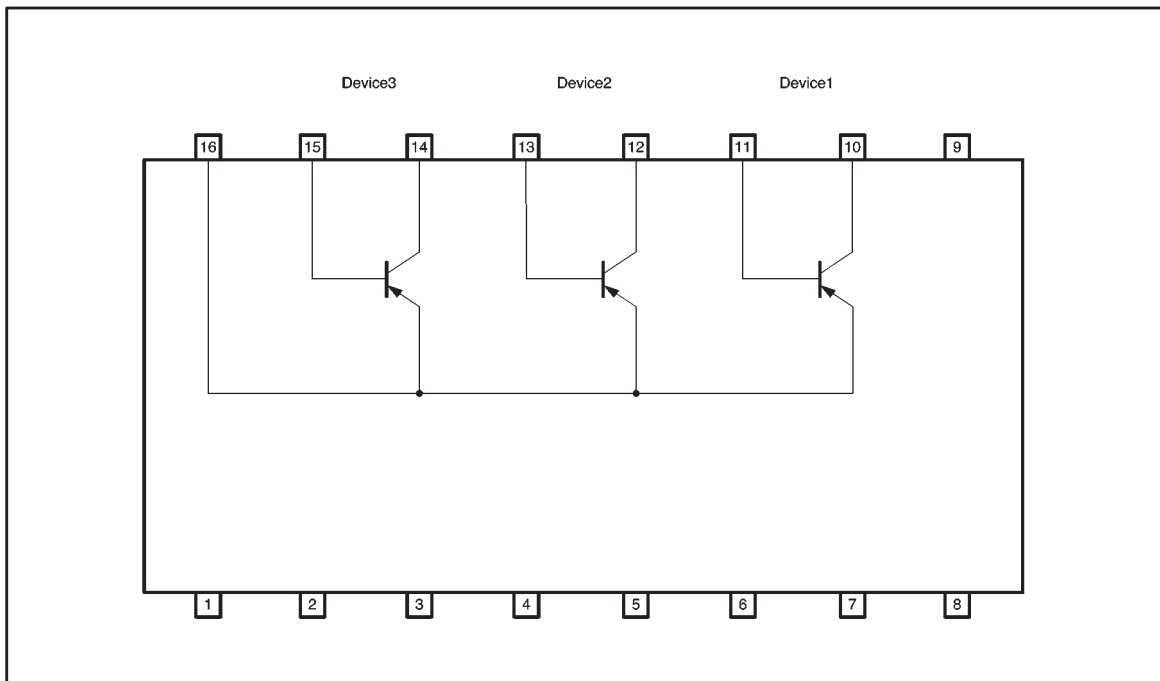

● Pin descriptions

Pin No.	Pin name	Function
1	N.C.	N.C.
2	N.C.	N.C.
3	N.C.	N.C.
4	N.C.	N.C.
5	N.C.	N.C.
6	N.C.	N.C.
7	N.C.	N.C.
8	N.C.	N.C.
9	N.C.	N.C.
10	1ch-C	Channel 1 collector
11	1ch-B	Channel 1 base
12	2ch-C	Channel 2 collector
13	2ch-B	Channel 2 base
14	3ch-C	Channel 3 collector
15	3ch-B	Channel 3 base
16	Emit	Common emitter for channels 1 to 3

●Electrical characteristics (unless otherwise noted, Ta = 25°C)

Parameter	Symbol	Min.	Typ.	Max.	Unit	Conditions
Collector / emitter voltage drop	$V_{CE0}$	-20	—	—	V	$I_C = -1\text{mA}$
Collector / base voltage drop	$V_{CB0}$	-20	—	—	V	$I_C = -50\ \mu\text{A}$
Emitter / base voltage drop	$V_{EB0}$	-6	—	—	V	$I_E = -50\ \mu\text{A}$
Collector cutoff current	$I_{CB0}$	—	—	-1.0	$\mu\text{A}$	$V_{CB} = -20\text{V}$
Emitter cutoff current	$I_{EB0}$	—	—	-1.0	$\mu\text{A}$	$V_{EB} = -5\text{V}$
Collector saturation voltage	$V_{CE}(\text{sat})$	—	—	-0.4	V	$I_C / I_B = -1.0\text{A} / -50\text{mA}^{*1}$
DC current gain	$h_{FE}$	120	—	270	—	$V_{CE} / I_C = -2\text{V} / -0.1\text{A}^{*1}$
	$\Delta h_{FE}^{*2}$	—	—	20	—	$V_{CE} / I_C = -2\text{V} / -0.1\text{A}^{*1}$

\* The above ratings apply to each transistor.

\*1 Pulse test.

\*2  $h_{FE}$  difference between the three transistors.

©Not designed for radiation resistance.

●Operation notes

Observe the following points when using this IC.

(1) Package power dissipation

The power dissipated by the IC varies widely with the applied voltage and output current.

Give full consideration to the package power dissipation rating when setting the supply voltage and the output current.

(2) A.S.O.

Make sure that the output current and supply voltage do not exceed the A.S.O. values.

(3) Great care has been paid to the quality of this component. However, if the absolute maximum ratings for temperature, applied voltage, or power dissipation are exceeded, the IC may be destroyed. If the IC is destroyed, it is not possible to predict whether it will be in short mode or open mode, so if there is a chance that the maximum ratings of the IC will be exceeded, use appropriate physical protective measures (fuses etc.).

●Electrical characteristics curves

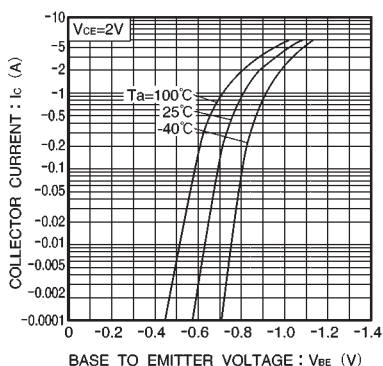

Fig.1 Emitter propagation static characteristics

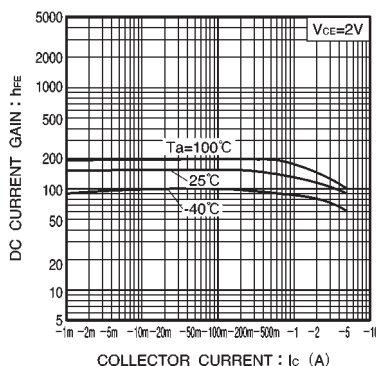

Fig.2 DC current gain vs. collector current

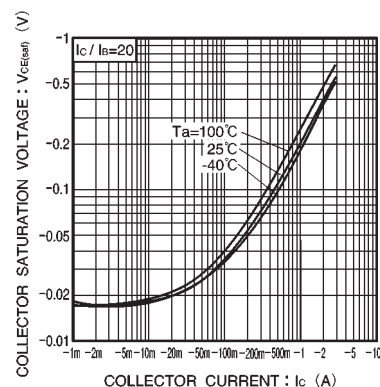
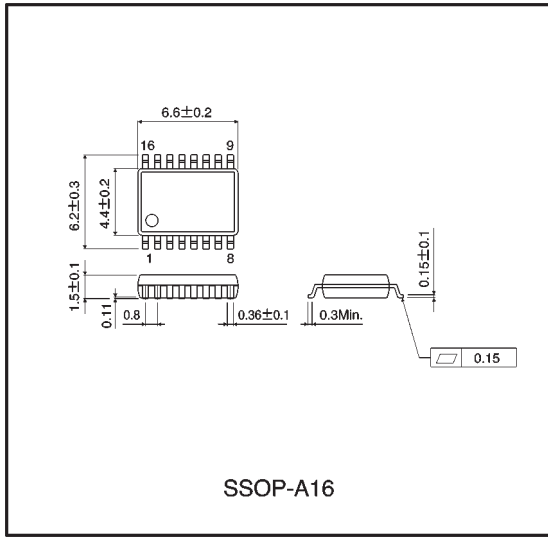



Fig.3 Collector/emitter saturation voltage vs. collector current

● External dimensions (Units: mm)



## Looking for pricing, stock, or lifecycle information?

Click below to explore more details on WIN SOURCE:

-  [View BA6254FS-E2 on WIN SOURCE](#)
-  [Rohm Semiconductor Information](#)

## Optimize Your Supply Chain with WIN SOURCE Solutions

-  Global Sourcing Solution
-  Obsolete Management
-  Cost Control Management
-  Shortage Management
-  Alternative Solution
-  Excess Inventory Management